

MONITOUCH

Hardware Specifications



V9 series

Record of Revisions

Reference numbers are shown at the bottom left corner on the back cover of each manual.

Printing Date	Reference No.	Revised Contents
May 2014	2023NE0	First edition
February 2015	2023NE1	Second edition [Partial amendment] <ul style="list-style-type: none"> Revised note regarding when the screen becomes dark in "Notes on Safe Usage of MONITOUCH" [Additions] <ul style="list-style-type: none"> Advanced model (V9101iW) Notes regarding capacitive touch panels in "Notes on Safe Usage of MONITOUCH" Peripheral equipment (DUR-00, CUR-00, CUR-01, CUR-03, CUR-06, CUR-08, GUR-01, GUR-02, GUR-04, V9-ANT) Screen configuration environment OS: Windows 8.1 V9120iS, V9071iW Models produced on order (V9100iSLD, V9100iSRD, V9100iW series, V9080iSLD, V9080iSRD)
June 2015	2023NE2	Third edition [Additions] <ul style="list-style-type: none"> V9150iX, V9070iW, V9060iTD Peripheral equipment (CUR-02, CUR-04, CUR-07)

Preface

Thank you for selecting the MONITOUCH V9 series.

This manual describes operation procedures and errors of the V9 series in detail.

For correct use of the V9 series, you are requested to read through this manual to understand more about the product.

The manuals shown below are related manuals for the V9 series. Refer to them as necessary.

Manual Name	Contents	Reference No.
V9 Series Reference Manual [1]	Explains the functions and operation of the V9 series.	1065NE
V9 Series Reference Manual [2]		1066NE
V9 Series Setup Manual	Explains the installation procedure of V-SFT version 6, the creation process of simple screen programs as well as how to transfer a created screen program using V-SFT version 6.	1067NE
V9 Series Troubleshooting/Maintenance Manual	Provides an error list and explains the operating procedures for the V9 series.	1068NE
V9 Series Training Manual Beginner's Guide	Explains the screen creation process using V-SFT version 6 with examples in detail.	1069NE
V9 Series Training Manual Practical Guide		1070NE
V9 Series Macro Reference	Provides an overview of macros of V-SFT version 6 and explains macro editor operations and macro command descriptions in detail.	1071NE
V9 Series Operation Manual	Explains the configuration of V-SFT version 6, the editing process of each part and limitations regarding operation in detail.	1072NE
V9 Series Connection Manual [1]	Explains the connection and communication parameters for the V9 series and controllers in detail. Included Makers ALLEN BRADLEY, Automationdirect, Azbil, Baumuller, BECKHOFF, CHINO, CIMON, DELTA, DELTA TAU DATA SYSTEMS, EATON Cutler-Hammer, EMERSON, FANUC, FATEK AUTOMATION, FUFENG, Fuji Electric, Gammaflux, GE Fanuc, Hitachi, Hitachi Industrial Equipment Systems	2210NE
V9 Series Connection Manual [2]	Explains the connection and communication parameters for the V9 series and controllers in detail. Included Makers IAI, IDEC, JTEKT, KEYENCE, KOGANEI, KOYO ELECTRONICS, LS, MITSUBISHI ELECTRIC, MODICON, MOELLER, M-SYSTEM, OMRON, Oriental Motor, Panasonic, RKC, RS Automation	2211NE

Manual Name	Contents	Reference No.
V9 Series Connection Manual [3]	Explains the connection and communication parameters for the V9 series and controllers in detail. Included Makers SAIA, SAMSUNG, SanRex, SANMEI, SHARP, SHIMADEN, SHINKO TECHNOS, Siemens, SINFONIA TECHNOLOGY, TECO, Telemecanique, TOHO, TOSHIBA, TOSHIBA MACHINE, TURCK, UNIPULSE, UNITRONICS, VIGOR, WAGO, XINJE, YAMAHA, Yaskawa Electric, Yokogawa Electric, MODBUS, Barcode Reader, Slave Communication Function, Universal Serial Communication	2212NE

For further details about controllers (PLCs, temperature controllers, etc.), refer to the manual issued by each controller manufacturer.

Notes:

1. This manual may not, in whole or in part, be printed or reproduced without the prior written consent of Hakko Electronics Co., Ltd.
2. The information in this manual is subject to change without prior notice.
3. Windows and Excel are registered trademarks of Microsoft Corporation in the United States and other countries.
4. All other company names or product names are trademarks or registered trademarks of their respective holders.
5. This manual is intended to give accurate information about MONITOUCH hardware. If you have any questions, please contact your local distributor.

Types and Model Names of the V9 Series

The MONITOUCH V9 series comprises the following types.

General Name	Model Classification	Model
V9 series	Advanced model	V910xiW, V907xiW
	Standard model	V9150iX, V9120iS, V9100iS, V9080iSD
	Lite model	V9100iC, V9080iCD, V9060iTD

General Name	Model Classification	Model
V9 series	Additional wired LAN I/F model	V9 model name with "L" added Example: V9101iWLD
	Wireless LAN I/F model	V9 model name with "R" added Example: V9101iWRDL

Note that model names are differentiated according to the above descriptions in this manual for operation explanations.

Notes on Safe Usage of MONITOUCH

In this manual, you will find various notes categorized under the following levels with the signal words "DANGER" and "CAUTION".



DANGER

Indicates an imminently hazardous situation which, if not avoided, will result in death or serious injury.



CAUTION

Indicates a potentially hazardous situation which, if not avoided, may result in minor or moderate injury and could cause property damage.

Note that there is a possibility that items listed with  CAUTION may have serious ramifications.



DANGER

- Never use the output signal of the V9 series for operations that may threaten human life or damage the system, such as signals used in case of emergency. Please design the system so that it can cope with a touch switch malfunction. A touch switch malfunction may result in machine accidents or damage.
- Turn off the power supply when you set up the unit, connect new cables, or perform maintenance or inspections. Otherwise, electrical shock or damage may occur.
- Never touch any terminals while the power is on. Otherwise, electrical shock may occur.
- You must cover the terminals on the unit before turning the power on and operating the unit. Otherwise, electrical shock may occur.
- The liquid crystal in the LCD panel is a hazardous substance. If the LCD panel is damaged, do not ingest the leaked liquid crystal. If leaked liquid crystal makes contact with skin or clothing, wash it away with soap and water.
- Never disassemble, recharge, deform by pressure, short-circuit, reverse the polarity of the lithium battery, nor dispose of the lithium battery in fire. Failure to follow these conditions will lead to explosion or ignition.
- Never use a lithium battery that is deformed, leaking, or shows any other signs of abnormality. Failure to follow these conditions will lead to explosion or ignition.
- Switches on the screen are operable even when the screen has become dark due to a faulty backlight or when the backlight has reached the end of its service life. If the screen is dark and hard to see, do not touch the screen. Otherwise, a malfunction may occur resulting in machine accidents or damage.



CAUTION

- Check the appearance of the unit when it is unpacked. Do not use the unit if any damage or deformation is found. Failure to do so may lead to fire, damage, or malfunction.
- For use in a facility or as part of a system related to nuclear energy, aerospace, medical, traffic equipment, or mobile installations, please consult your local distributor.
- Operate (or store) the V9 series under the conditions indicated in this manual and related manuals. Failure to do so could cause fire, malfunction, physical damage, or deterioration.
- Observe the following environmental restrictions on use and storage of the unit. Otherwise, fire or damage to the unit may result.
 - Avoid locations where there is a possibility that water, corrosive gas, flammable gas, solvents, grinding fluids, or cutting oil can come into contact with the unit.
 - Avoid high temperatures, high humidity, and outside weather conditions, such as wind, rain, or direct sunlight.
 - Avoid locations where excessive dust, salt, and metallic particles are present.
 - Avoid installing the unit in a location where vibrations or physical shocks may be transmitted.

 **CAUTION**

- Equipment must be correctly mounted so that the main terminal of the V9 series will not be touched inadvertently. Otherwise, an accident or electric shock may occur.
- Tighten the mounting screw on the fixtures of the V9 series to an equal torque of 5.31 lbf-in (0.6 N·m). Excessive tightening may distort the panel surface. Loose mounting screws may cause the unit to fall down, malfunction, or short-circuit.
- Check periodically that terminal screws on the power supply terminal block and fixtures are firmly tightened. Loosened screws or nuts may result in fire or malfunction.
- Tighten the terminal screws on the power supply terminal block of the V9 series to an equal torque of 7.1 to 8.8 lbf-in (0.8 to 1.0 N·m). Improper tightening of screws may result in fire, malfunction, or other serious trouble.
- The V9 series has a glass screen. Do not drop the unit or impart physical shocks to the unit. Otherwise, the screen may be damaged.
- Correctly connect cables to the terminals of the V9 series in accordance with the specified voltage and wattage. Overvoltage, overwattage, or incorrect cable connection could cause fire, malfunction, or damage to the unit.
- Always ground the V9 series. The FG terminal must be used exclusively for the V9 series with the level of grounding resistance less than 100 Ω. Otherwise, you may sustain an electric shock, a fire may occur, MONITOUCH may not recognize touch operations, and malfunctions may occur.
- Prevent any conductive particles from entering the V9 series. Failure to do so may lead to fire, damage, or malfunction.
- After wiring is finished, remove the paper used as a dust cover before starting operation of the V9 series. Operation with the dust cover attached may result in accidents, fire, malfunction, or other trouble.
- Do not attempt to repair the V9 series yourself. Contact Hakko Electronics or the designated contractor for repairs.
- Do not repair, disassemble, or modify the V9 series. Hakko Electronics Co., Ltd. is not responsible for any damages resulting from repair, disassembly, or modification of the unit that was performed by an unauthorized person.
- Do not use sharp-pointed tools to press touch switches. Doing so may damage the display unit.
- Only experts are authorized to set up the unit, connect cables, and perform maintenance and inspection.
- Lithium batteries contain combustible material such as lithium and organic solvents. Mishandling may cause heat, explosion, or ignition resulting in fire or injury. Read the related manuals carefully and correctly handle the lithium battery as instructed.
- Take safety precautions during operations such as changing settings when the unit is running, forced output, and starting and stopping the unit. Any misoperations may cause unexpected machine movement, resulting in machine accidents or damage.
- In facilities where the failure of the V9 series could lead to accidents that threaten human life or other serious damage, be sure that such facilities are equipped with adequate safeguards.
- When disposing of the V9 series, it must be treated as industrial waste.
- Before touching the V9 series, discharge static electricity from your body by touching grounded metal. Excessive static electricity may cause malfunction or trouble.
- Insert an SD card into MONITOUCH in the same orientation as pictured on the unit. Failure to do so may damage the SD card or the slot on the unit.
- The SD card access LED flashes red when the SD card is being accessed. Never remove the SD card or turn off power to the unit while the LED is flashing. Doing so may destroy the data on the SD card. Check that the LED has turned off before removing the SD card or turning off the power to the unit.
- Be sure to remove the protective sheet that is attached to the touch panel surface at delivery before use. Using MONITOUCH with the protective sheet attached may result in incorrect touch switch activation.
- When using an analog resistive-film type V9 series unit, do not touch two positions on the screen at the same time. If two or more positions are pressed at the same time, the switch located between the pressed positions may be activated.

 **CAUTION**

- When using a V9 series unit of the capacitive type, observe the following points.
 - Use a Class 2 power supply for the 24 VDC power unit. Using MONITOUCH with an unstable power supply may result in incorrect touch switch activation.
 - Capacitive touch panel types support two-point touch operations. If a third point is touched, the touch operation will be cancelled.
 - Capacitive touch panel types are prone to the influence of conductive material. Do not place conductive material such as metals near the touch panel surface and do not use the panel if it is wet. Otherwise, malfunctions may occur.

[General Notes]

- Never bundle control cables or input/output cables with high-voltage and large-current carrying cables such as power supply cables. Keep control cables and input/output cables at least 200 mm away from high-voltage and large-current carrying cables. Otherwise, malfunction may occur due to noise.
- When using the V9 series in an environment where a source of high-frequency noise is present, it is recommended that the FG shielded cable (communication cable) be grounded at each end. However, when communication is unstable, select between grounding one or both ends, as permitted by the usage environment.
- Be sure to plug connectors and sockets of the V9 series in the correct orientation. Failure to do so may lead to damage or malfunction.
- If a LAN cable is inserted into the MJ1 or MJ2 connector, the device on the other end may be damaged. Check the connector names on the unit and insert cables into the correct connectors.
- Do not use thinners for cleaning because it may discolor the V9 series surface. Use commercially available alcohol.
- If a data receive error occurs when the V9 series unit and a counterpart unit (PLC, temperature controller, etc.) are started at the same time, read the manual of the counterpart unit to correctly resolve the error.
- Avoid discharging static electricity on the mounting panel of the V9 series. Static charge can damage the unit and cause malfunctions. Discharging static electricity on the mounting panel may cause malfunction to occur due to noise.
- Avoid prolonged display of any fixed pattern. Due to the characteristic of liquid crystal displays, an afterimage may occur. If prolonged display of a fixed pattern is expected, use the backlight's auto OFF function.
- The V9 series is identified as a class-A product in industrial environments. In the case of use in a domestic environment, the unit is likely to cause electromagnetic interference. Preventive measures should thereby be taken appropriately.
- The signal ground (SG) and frame ground (FG) are connected inside the V9150 series unit. Take care when designing systems.

[Notes on the LCD]

Note that the following conditions may occur under normal circumstances.

- The response time, brightness, and colors of the V9 series may be affected by the ambient temperature.
- Tiny spots (dark or luminescent) may appear on the display due to the characteristics of liquid crystal.
- There are variations in brightness and color between units.

[Notes on Capacitive Touch Panels]

- Touch panel operability may not be optimal if used with dry fingers or skin. In such a case, use a capacitive stylus pen.
- Periodically clean the touch panel surface for optimum touch operations.

When cleaning, take note of the following points.

<When cleaning>

- The panel surface is made of glass. Be sure to clean the surface gently with a cloth or sponge. Otherwise, you may scratch or damage the glass.
- Take care not to let cleaning detergent seep into the touch panel unit.
Do not directly apply or spray cleaning detergent on the panel surface.

[Notes on Wireless LAN]

For details regarding supported wireless LAN standards, radio law certifications, and countries where wireless LAN can be used, refer to the "About Wireless LAN on V9 Advanced Model"/"About Wireless LAN on V9 Standard Model" manual or the "V9 Series Hardware Specifications" provided with the V9 series unit at delivery.

Contents

Preface

Notes on Safe Usage of MONITOUCH

Chapter 1

Product Outline

1. Features	1-1
2. Models and Peripheral Equipment	1-3
MONITOUCH Models	1-3
Lineup	1-3
Peripheral Equipment	1-7
3. System Configuration	1-10
Configuration for Advanced Models	1-10
Configuration for Standard Models	1-11
Configuration for Lite Models	1-12

Chapter 2

Specifications

1. Advanced Model.....	2-1
General Specifications	2-1
Installation Specifications	2-2
Display Specifications	2-2
Touch Switch Specifications	2-3
Wireless LAN Specifications (Only for Wireless LAN I/F Models).....	2-3
Interface Specifications	2-4
Clock and Backup Memory Specifications	2-5
Screen Configuration Environment	2-5
Display Function Specifications	2-5
Function Performance Specifications.....	2-6
V9101iW External Dimensions and Panel Cut-out Dimensions.....	2-7
V9100iW External Dimensions and Panel Cut-out Dimensions.....	2-8
V9071iW External Dimensions and Panel Cut-out Dimensions.....	2-9
V9070iW External Dimensions and Panel Cut-out Dimensions.....	2-10
V907xiW with DUR-00 External Dimensions and Panel Cut-out Dimensions.....	2-11
2. Standard Model	2-12
General Specifications	2-12
Installation Specifications	2-14
Display Specifications	2-14
Touch Switch Specifications	2-15
Wireless LAN Specifications (Only for Wireless LAN I/F Models).....	2-15
Function Switch Specifications.....	2-15
Interface Specifications	2-15
Clock and Backup Memory Specifications	2-16
Screen Configuration Environment	2-16
Display Function Specifications	2-17
Function Performance Specifications.....	2-18
V9150ix External Dimensions and Panel Cut-out Dimensions	2-19

V9120iS External Dimensions and Panel Cut-out Dimensions	2-20
V9100iS External Dimensions and Panel Cut-out Dimensions	2-21
V91080iSD External Dimensions and Panel Cut-out Dimensions	2-22
3. Lite Model	2-23
General Specifications	2-23
Installation Specifications	2-25
Display Specifications	2-25
Touch Switch Specifications	2-25
Function Switch Specifications	2-26
Interface Specifications	2-26
Clock and Backup Memory Specifications	2-27
Screen Configuration Environment	2-27
Display Function Specifications	2-27
Function Performance Specifications	2-28
V9100iC External Dimensions and Panel Cut-out Dimensions	2-29
V9080iCD External Dimensions and Panel Cut-out Dimensions	2-30
V9060iTD External Dimensions and Panel Cut-out Dimensions	2-31

Chapter 3 Names and Specifications of Components

1. Names and Functions of Components	3-1
Advanced Model	3-1
Standard Model	3-5
Lite Model	3-8
2. Specifications of Components	3-12
Serial Connector (CN1)	3-12
Modular Jack (MJ1/MJ2)	3-13
USB-A (Master Port)	3-15
USB mini-B (Slave Port)	3-19
LAN Connector (LAN)	3-20
Additional LAN Connector (LAN2) (Only for Additional Wired LAN I/F Models)	3-21
Connector for Wireless LAN Dipole Antenna (WLAN) (Only for Wireless LAN I/F Models)	3-22
Communication Interface Unit Connector (EXT1)	3-25
Optional Unit Connector (EXT2) (V910xiW/Standard Models Only)	3-26
SD Card Interface (SD)	3-27
Audio Output Connector (AUDIO) (V910xiW/Standard Models Only)	3-29
DIP Switches (DIPSW)	3-30

Chapter 4 Installation

1. Installation Procedure	4-1
Installation Procedure	4-1
Installation Conditions	4-3
2. Power Supply Cable and Grounding Connections	4-5
Power Supply Cable Connection	4-5
Notes on Usage of the 100 to 240 VAC Specification	4-6
Grounding	4-6

3. Securing USB Cables.....	4-7
4. Inserting and Removing SD Cards.....	4-8
SD Card Insertion/Removal Procedure.....	4-8
5. Installing the Battery.....	4-9
Role of the Battery	4-9
Battery Replacement Period	4-9
Battery Voltage Drop Detection.....	4-9
Battery Replacement	4-9
Notes on the Battery: EU Directive 2006/66/EC	4-14

Chapter 5 Inspection and Maintenance

1. Inspection and Maintenance	5-1
Daily Inspection.....	5-1
Periodical Inspection.....	5-1
2. Warranty Policy	5-2
Inquiries about Failure	5-2
Warranty Period.....	5-2
Free-of-charge Repair.....	5-2
Chargeable Repair.....	5-2
Inquiry Form.....	5-3

1

Product Outline

1. Features
2. Models and Peripheral Equipment
3. System Configuration

1. Features

The V9 series inherits and improves on the features of the V8 series as described below.

1. A programmable display unit that offers a maximum of 16.77 million display colors (262 thousand colors maximum for V9060iTD) * and an LCD with an LED backlight. V9 series units are divided into the following model types.
 - * Only for displaying "picture" images and 3D parts. All other content is displayed using 65,536 colors.
 - **Advanced model:**
A high-definition/resolution and high-performance model standardly equipped with a wide high-resolution LCD, two wired LAN connectors, and connectors for communication interface units. Capacitive touch panel types are also available.
 - **Standard model:**
A high-performance model equipped with connectors for communication interface units, connectors for optional units, and an audio output connector as standard.
 - **Lite model:**
A basic model that does not include the connectors for optional units or the audio output connector.
2. **Improved performance**
High-speed processing and rapid rendering can be achieved through the adoption of a high-performance processor and significantly increased CPU clock speed.
3. **LAN connectors standard on all models**
All models are equipped with LAN connectors (10BASE-T/100BASE-TX).
The Advanced model is equipped with two LAN connectors as standard.
4. **SD card interface as standard**
All models are equipped with an SD/SDHC card interface as standard.
SD cards can be used as storage for saving screen programs and logging/alarm data, and transferring recipe data.
5. **Wireless LAN function as standard**
Models are equipped with a wireless LAN function compliant with IEEE802.11b/g/n as standard.
An access point is built-in, allowing direct communication with devices equipped with wireless LAN function such as tablets.
 - * Only for wireless LAN I/F models
6. **Scrolling function**
Single screens can be registered at sizes higher than the resolution of the display unit and the scrolling function can be used to display each part of such screens.
According to screen configuration, this function can be used to display screens of sizes that extend in the horizontal and vertical directions.
In addition, navigation display is supported which allows users to instantly check the current display position.
7. **Zoom in/out function**
Screens can be zoomed in by a maximum of 200 % using pinch-in and pinch-out gestures.
This enables users to check parts that are small and difficult to see.
 - * Only for Advanced models. Standard and Lite models can be zoomed in/out by double-tapping.
8. **VNC server function**
All models can be remotely monitored and operated from a computer or tablet.
Server functions can be limited to remote monitoring as necessary.
9. **VPN function**
All models are equipped with a VPN function, enabling safe, simple and low-cost VPN communication.
For 2CH/3CH LAN types, the routing function can be used to establish remote connection to devices connected to the V9 series unit via Ethernet, such as a PLC and network camera.

10. Scheduler function

Predetermined operations (turning bits ON, executing macros, etc.) can be executed at a time set in advance, such as every week, every day, or a specified time. Operations such as periodical saving of logging/alarm data can be scheduled easily.

11. TrueType font

TrueType fonts enable smoother character expression through anti-aliasing processing.

2. Models and Peripheral Equipment

MONITOUCH Models

The model name consists of the following information.

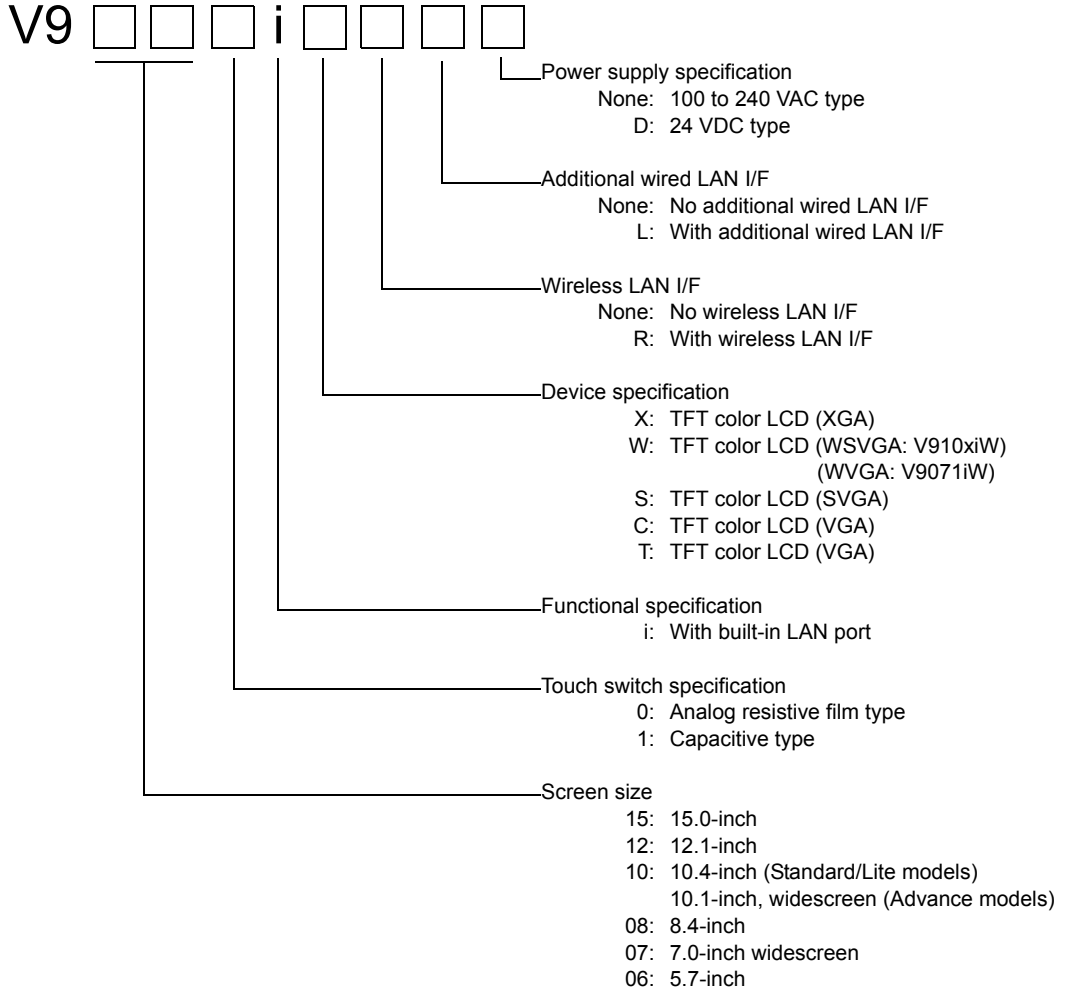

Lineup

Model	15.0-inch	12.1-inch	10.4-inch		10.1-inch Widescreen	8.4-inch		7.0-inch Widescreen	5.7-inch
	XGA (1024×768)	SVGA (800 × 600)	SVGA (800 × 600)	VGA (640 × 480)	WSVGA (1024 × 600)	SVGA (800 × 600)	VGA (640 × 480)	WVGA (800 × 480)	VGA (640×480)
Advanced		-	-	-	V9101IWRLD V9100IWRLD V9101IWLD V9100IWLD	-	-	V9071IWRLD V9070IWRLD V9071IWLD V9070IWLD	-
Standard	V9150iX V9150iXD V9150iXLD V9150iXRD	V9120iS V9120iSD V9120iSLD V9120iSRD	V9100iS V9100iSD V9100iSLD V9100iSRD	-	-	V9080iSD V9080iSLD V9080iSRD	-	-	-
Lite		-	-	V9100iC V9100iCD	-	-	V9080iCD	-	V9060iTD

Advanced Model

A high-definition/resolution and high-performance model standardly equipped with a wide high-resolution LCD, two wired LAN connectors, and connectors for communication interface units. Capacitive touch panel types are also available.

- Unit specifications

Model	Display Device	Resolution	Touch switch	Power supply type
V9101iWRLD	10.1-inch Widescreen	1024 × 600 dots	Capacitive type	DC power supply
V9100iWRLD			Analog resistive film type	
V9101iWLD			Capacitive type	
V9100iWLD			Analog resistive film type	
V9071iWRLD	7.0-inch Widescreen	800 × 480 dots	Capacitive type	DC power supply
V9070iWRLD			Analog resistive film type	
V9071iWLD			Capacitive type	
V9070iWLD			Analog resistive film type	

- External I/F

Model	Communication I/F Unit	Optional Units	Audio Output	Wireless LAN	Additional Wired LAN
V9101iWRLD	○	○	○	○	○
V9100iWRLD				×	
V9101iWLD				×	
V9100iWLD				×	
V9071iWRLD	○	× *	×	○	○
V9070iWRLD				×	
V9071iWLD				×	
V9070iWLD				×	

*When attaching the optional "DUR-00" unit, connect it to the communication I/F unit connector.

- Standards

Model	UL508	ANSI/ISA	CE	KC	Wireless Standards Certification in:
V9101iWRLD	○	×	○	○	Japan, Europe, USA, Korea
V9100iWRLD					
V9101iWLD					
V9100iWLD					
V9071iWRLD	○	×	○	○	Japan, Europe, USA, Korea
V9070iWRLD					
V9071iWLD					
V9070iWLD					

Standard Models

A high-performance model equipped with connectors for communication interface units, connectors for optional units, and an audio output connector as standard.

- Unit specifications

Model	Display Device	Resolution	Touch switch	Power supply type
V9150iX	15.0-inch	1024 × 768 dots	Analog resistive film type	AC power supply
V9150iXD				DC power supply
V9150iXLD				
V9150iXRD				
V9120iS	12.1-inch	800 × 600 dots	Analog resistive film type	AC power supply
V9120iSD				DC power supply
V9120iSLD				
V9120iSRD				
V9100iS	10.4-inch	800 × 600 dots	Analog resistive film type	AC power supply
V9100iSD				DC power supply
V9100iSLD				
V9100iSRD				
V9080iSD	8.4-inch	800 × 600 dots	Analog resistive film type	DC power supply
V9080iSLD				
V9080iSRD				

- External I/F

Model	Communication I/F Unit	Optional Units	Audio Output	Wireless LAN	Additional Wired LAN
V9150iX	○	○	○	×	×
V9150iXD					○
V9150iXLD				○	×
V9150iXRD					
V9120iS	○	○	○	×	×
V9120iSD					○
V9120iSLD				○	×
V9120iSRD					
V9100iS	○	○	○	×	×
V9100iSD					○
V9100iSLD				○	×
V9100iSRD					
V9080iSD	○	○	○	×	×
V9080iSLD					○
V9080iSRD				○	×

- Standards

Model	UL508	ANSI/ISA	CE	KC	Wireless Standards Certification in:
V9150iX	×	×	×	○	×
V9150iXD	○		○		
V9150iXLD			×	×	
V9150iXRD				Japan	

Model	UL508	ANSI/ISA	CE	KC	Wireless Standards Certification in:
V9120iS	×	×	×	○	×
V9120iSD	○	○*	○		
V9120iSLD		×	×	×	Japan
V9120iSRD					
V9100iS	×	×	×	○	×
V9100iSD	○	○*	○		
V9100iSLD		×	×	×	Japan
V9100iSRD					
V9080iSD	○	○*	○	○	×
V9080iSLD		×	×		
V9080iSRD					

*Hardware version b and later

Lite Models

A basic model that does not include the connectors for optional units or the audio output connector.

- Unit specifications

Model	Display Device	Resolution	Touch switch	Power supply type
V9100iC	10.4-inch	640 × 480 dots	Analog resistive film type	AC power supply
V9100iCD				DC power supply
V9080iCD	8.4-inch	640 × 480 dots	Analog resistive film type	DC power supply
V9060iTD	5.7-inch	640 × 480 dots	Analog resistive film type	DC power supply

- External I/F

Model	Communication I/F Unit	Optional Units	Audio Output	Wireless LAN	Additional Wired LAN
V9100iC	○	×	×	×	×
V9100iCD					
V9080iCD	○	×	×	×	×
V9060iTD	○	×*	×	×	×

*When attaching the optional "DUR-00" unit, connect it to the communication I/F unit connector.

- Standards

Model	UL508	ANSI/ISA	CE	KC	Wireless Standards Certification in:
V9100iC	×	×	×	○	×
V9100iCD	○		○		
V9080iCD	○	×	○	○	×
V9060iTD	○	○	○	○	×

Peripheral Equipment

The following software and equipment are available as options for the V9 series.

Drawing Tool

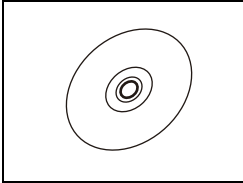

V-SFT-6 (configuration software)

Application software for editing MONITOUCH screen programs.

Supported OS:

Windows XP, XP 64 Edition, Vista (32-bit, 64-bit), 7 (32-bit, 64-bit), 8 (32-bit, 64-bit) / 8.1 (32-bit, 64-bit)

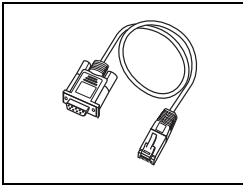

V-CP (screen program transfer cable) 3 m

A cable used for connecting the V9 series unit to a computer.

Optional Units

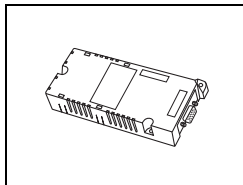

GUR-xx

Optional units for the V910xiW and Standard models.

GUR-01 → RGB input 1CH
GUR-02 → RGB output 1CH
GUR-04 → Video input 1CH

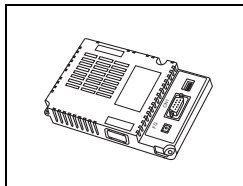

DUR-00

Optional unit for the V907xiW/V9060iTD.

Supports D-sub 9-pin connectors.

* This unit cannot be used together with a "CUR-xx" communication interface unit.

Communication Interface Unit

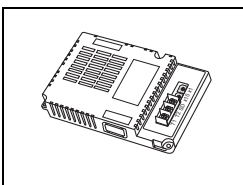

CUR-xx

Communication units used for connecting to networks.

* These units cannot be used together with the optional "DUR-00" unit.

CUR-00 → OPCN-1
CUR-01 → T-Link
CUR-02 → CC-Link
CUR-03 → Ethernet
CUR-04 → PROFIBUS-DP
CUR-06 → SX-BUS
CUR-07 → DeviceNet
CUR-08 → FL-net

Cables

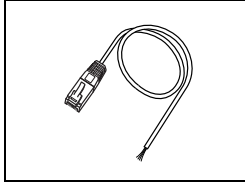

V6-BCD (barcode reader connection cable) 3 m
A cable used for connecting a barcode reader unit to the V9 series.

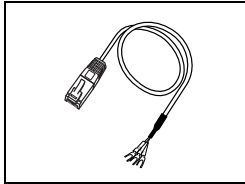

V6-MLT (multi-link2 master cable) 3 m
A cable used for multi-link2 connection between a V9 master station and V9 slave station.

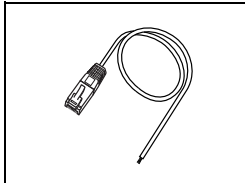

V6-TMP (connection cable for controllers)
A cable used for connecting the V9 series unit to a controller.
V6-TMP: 3 m
V6-TMP-5M: 5 m
V6-TMP-10M: 10 m

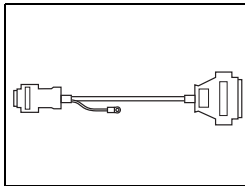

D9-D25 (D-sub 9-pin-to-25-pin conversion cable) 0.3 m
A conversion cable used for connecting the communication cable for the CN1 (D-sub 25-pin) of the V6/V7 series to the CN1 (D-sub 9-pin) of the V9 series.

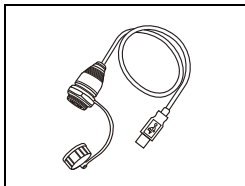

UA-FR (for USB-A port) 1 m
A cable for USB-A (master) that allows connection from the front of the control cabinet.

Protective Sheets

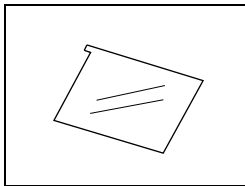

V9xxx-GS
A sheet used for protecting the operation panel surface (5 pcs./set).
V715X-GS → V9150, V815, V715 series
V912S-GS → V9120 series
V910S-GS → V9100 series
V910W-GS → V9100iW (analog resistive film type touch panel) *
V908S-GS → V9080 series
V907W-GS → V9070iW (analog resistive film type touch panel) *
V906T-GS → V9060iTD
* This sheet cannot be used for the V9101iW/V9071iW (capacitive type touch panel).

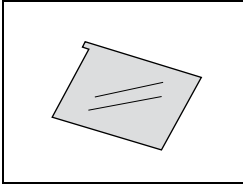
**V9xxx-GSN10**

A sheet used for protecting the operation panel surface (5 pcs./set, anti-glare treatment). The sheet is colored light gray and the graininess on its surface prevents light reflection.

V715X-GSN10 → V9150, V815, V715 series

V912S-GSN10 → V9120 series

V910S-GSN10 → V9100 series

V910W-GSN10 → V9100iW (analog resistive film type touch panel) *

V908S-GSN10 → V9080 series

V907W-GSN10 → V9070iW (analog resistive film type touch panel) *

V906T-GSN10 → V9060iTD

* This sheet cannot be used for the V9101iW/V9071iW (capacitive type touch panel).

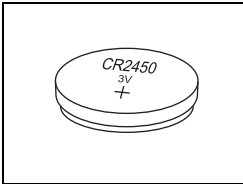
Other Options**V9-BT (replacement battery)**

A replacement lithium battery for the V9150/V9120/V9100/V910xiW/V9080 series (CR2450S manufactured by Sony Energy Devices).

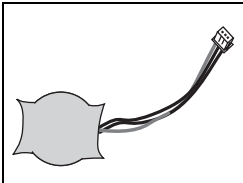
**V7-BT (replacement battery)**

A replacement lithium battery for V907xiW and V9060iTD.

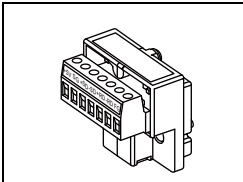
**TC-D9 (terminal converter)**

This converter is used for connection between the V9 series unit and a controller at the RS-422/485 terminal block via CN1 (D-sub 9-pin).

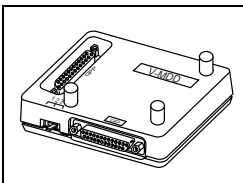
**V-MDD (ACPU/QnACPU/FXCPU dual port interface)**

An add-on connector with two ports and specifically designed for the connector on MITSUBISHI ACPU/QnACPU/FXCPU controllers. It is convenient to use this connector when directly connecting the V9 series unit to a ACPU/QnACPU/FXCPU controller.

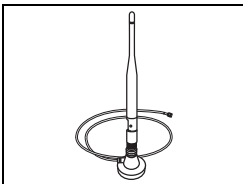
**V9-ANT (external dipole antenna for wireless LAN)**

An external dipole antenna (3 m) for V9 series units that support wireless LAN.

3. System Configuration

Configuration for Advanced Models

The following figure shows the possible system configurations when using the Advanced model.

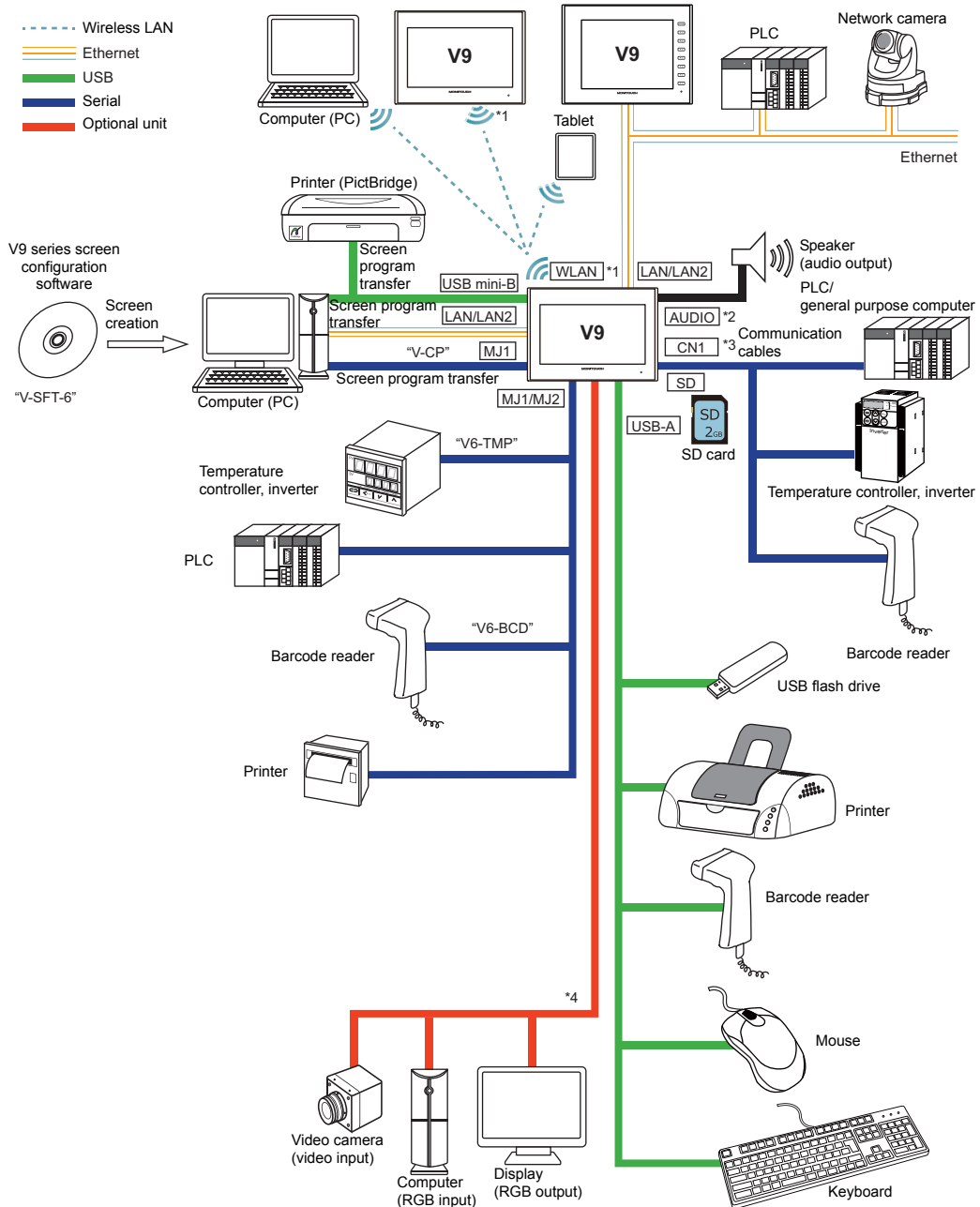

*1 Only for wireless LAN I/F models.
 *2 Only for V910xiW.
 *3 For the V907xiW, the optional "DUR-00" unit is required.
 *4 Only for V910xiW. The optional "GUR-xx" unit is required.

Configuration for Standard Models

The following figure shows the possible system configurations when using the Standard model.

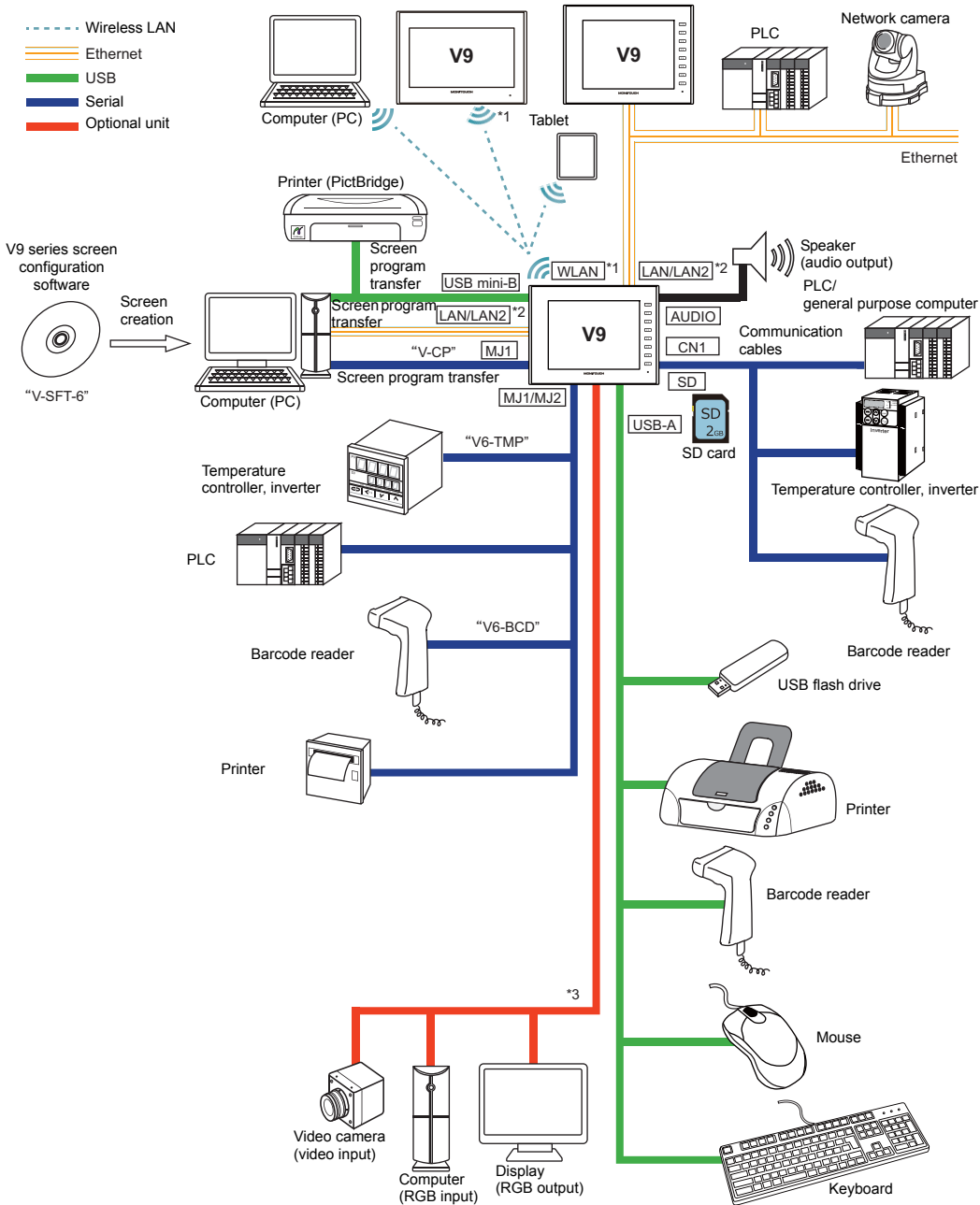

*1 Only for wireless LAN I/F models.
 *2 "LAN2" is only for additional wired LAN I/F models.
 *3 The optional "GUR-xx" unit is required.

Configuration for Lite Models

The following figure shows the possible system configurations when using the Lite model.

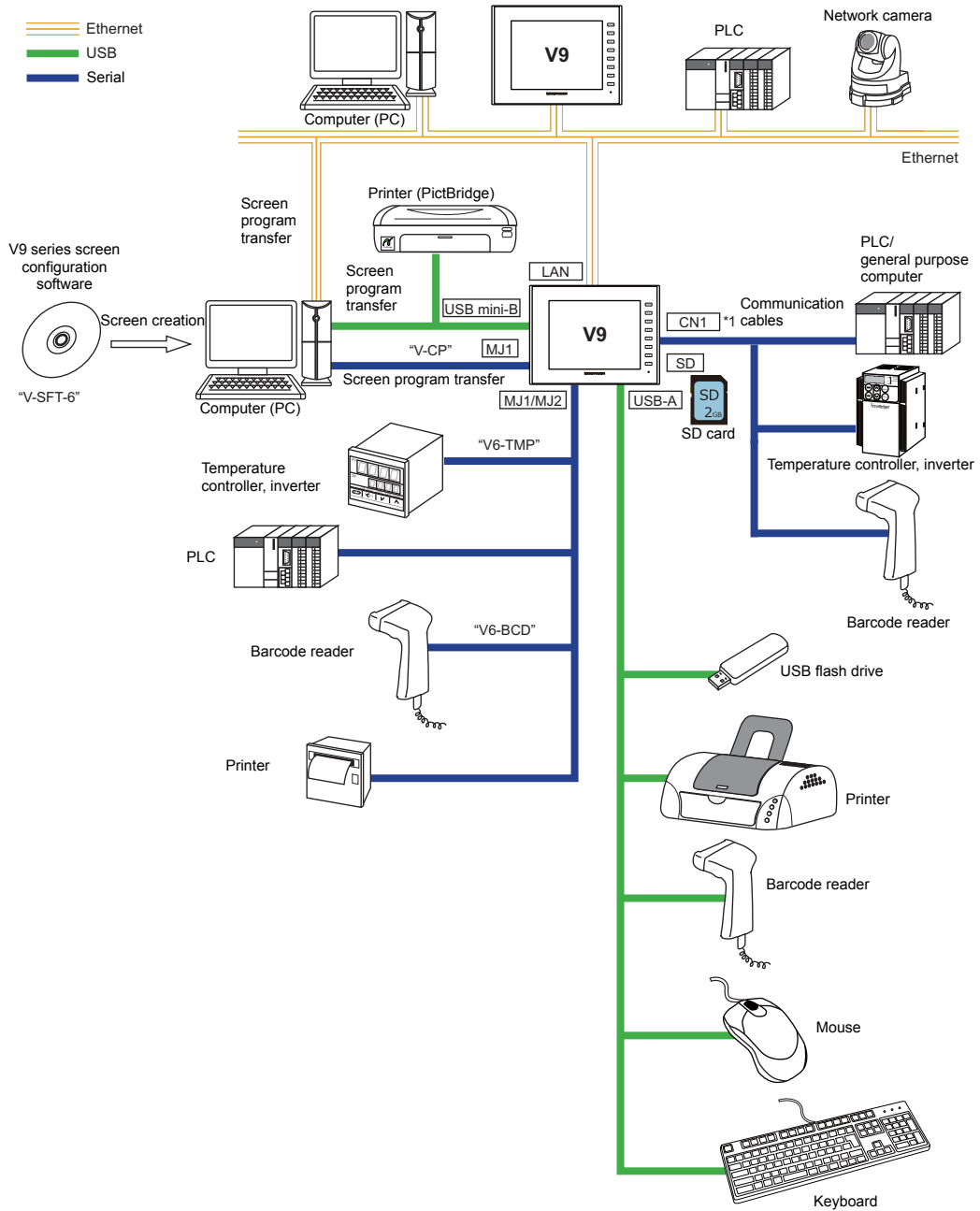

*1 For the V9060iTD, the optional "DUR-00" unit is required.

2 Specifications

1. Advanced Model
2. Standard Model
3. Lite Model

1. Advanced Model

General Specifications

Item		V9101iW	V9100iW	V9071iW	V9070iW
Conformance Standards		KC, CE (EN61000-6-2, EN61000-6-4), UL508 (File No.E313548), Radio laws (Japan: TELEC, USA: FCC, Canada: IC RSS, Europe: R&TTE, South Korea: KC) *1			
Power Supply	Permissible Voltage Range	24 VDC \pm 10 %			
	Permissible Momentary Power Failure	Within 1 ms			
	Power Consumption (Max. Rating)	27 W or less		22 W or less	
	Rush Current	17 A or less, 6 ms (ambient temperature at 25 °C)		10 A or less, 6 ms (ambient temperature at 25 °C)	
	Withstand Voltage	DC external terminals to FG: 500 VAC for 1 minute			
Insulation Resistance		DC external terminals to FG: 500 VDC, 10 M Ω or higher			
Physical Environment	Operational Ambient Temperature	0 °C to +50 °C *2			
	Storage Ambient Temperature	-10 °C to +60 °C *2			
	Operational Ambient Humidity	85 % RH or less (without dew condensation) *2			
	Storage Ambient Humidity	85 % RH or less (without dew condensation) *2			
	Altitude	2000 m or less			
	Atmosphere	No corrosive gas, no excessive dust, and no conductive dust			
	Overvoltage Category *3	Category II			
	Contamination Level *4	Contamination level 2			
Mechanical Working Conditions	Vibration Resistance	JIS B 3502 (IEC61131-2) compliant Vibration frequency: 5 to 9 Hz, Half-amplitude: 3.5 mm, Vibration frequency: 9 to 150 Hz, Constant acceleration: 9.8 m/s ² (1 G), X, Y, and Z: 3 directions (10 times each)			
	Shock Resistance	JIS B 3502 (IEC61131-2) compliant Peak acceleration: 147 m/s ² (15 G), X, Y, and Z: 3 directions, 3 times each (18 times in total)			
Electrical Working Conditions	Noise Resistance	Noise voltage: 1000 Vp-p, Pulse width: 1 μ s, Rising time: 1 ns (Measured using a noise simulator)			
	Static Electricity Discharge Resistance	Compliant with IEC61000-4-2, contact: 6 kV, air: 8 kV			
Mounting Conditions	Weight	Approx. 1.7 kg		Approx. 1.0 kg	
	Dimensions W \times H \times D	278.5 \times 198.5 \times 54.4 mm	278.5 \times 198.5 \times 53.2 mm	201.6 \times 147.6 \times 60.3 mm	201.6 \times 147.6 \times 59.1 mm
	Panel Cut-out Dimensions	257.0 ^{+0.5} \times 183.0 ^{+0.5} mm		187.2 ^{+0.5} \times 133.4 ^{+0.5} mm	
Case Color		Light gray			
Material		PC resin			

*1 This product complies with the following radio laws:

- TELEC (Japanese Radio Law: Technical Regulations Conformity Certification, Article 2, clause 1-19)
- FCC Part15 SubPart C
- IC RSS-210,RSS-Gen
- R&TTE: EN300328, EN301489-1, EN301489-17, EN62311, EN60950-1
- KC

The product will not conform to the above laws if using any antenna other than the built-in antenna of the V9 series unit or the optional V9-ANT for wireless LAN connection.

- *2 Use the unit in an environment where the wet-bulb temperature is 39 °C or less, otherwise the unit may be damaged.
- *3 This indicates the distribution section to which the unit is intended to be connected to within the path between the distribution of the public power network and machinery in the facility.
"Category II" applies to devices supplied with power from mains sockets or similar points. The withstand surge voltage is 2,500 V for devices rated up to 300 V.
- *4 This is an index that expresses the degree of conductive contamination in the environment where the unit is used.
"Contamination level 2" indicates the conditions where only non-conductive contamination occurs. However, due to condensation, temporary conductive contamination may occur.

Installation Specifications

Item		Specification
Grounding		Less than 100 Ω, FG/SG separated
Protection Structure	Panel Front Surface ^{*1}	Complies with IP66, Type 4X/13 ^{*2} (when waterproof gasket is installed)
	Rear Case	Complies with IP20
Cooling System		Natural cooling
Structure		Inserted in a mounting panel
Appropriate Mounting Panel Thickness		1.5 to 4 mm ^{*3}

- *1 Protective structure for the front when the V9 series unit is mounted on a mounting panel.
While the protective structure has passed compliance testing, it is not guaranteed under all environments.
- *2 Applies to V910xiW from hardware version c and later.
- *3 Even when the mounting panel thickness is within the specified range, the panel itself may warp depending on the material and size of the mounting panel.
Use a panel that can withstand the forces of mounting.

Display Specifications

Item	V9101iW	V9100iW	V9071iW	V9070iW
Display Device	TFT color			
Display Size	10.1-inch widescreen		7.0-inch widescreen	
Colors	16.77 million colors ^{*1}			
Resolution (W × H)	1024 × 600 dots		800 × 480 dots	
Dot Pitch (W × H)	0.2175 × 0.2088 mm		0.1905 × 0.1905 mm	
Actual Display Dimensions (W × H)	222.72 × 125.28 mm		152.4 × 91.44 mm	
Backlight	LED			
Backlight Brightness Halftime ^{*2}	Approx. 50,000 hours		Approx. 100,000 hours	
Backlight Auto OFF Function	Always ON, custom setting			
Brightness Adjustment	System menu: 16 levels Macro: 128 levels			
Touch Panel Operation Surface	Touch panel (Glass)	Surface sheet (PET, 0.188 mm)	Touch panel (Glass)	Surface sheet (PET, 0.188 mm)
POWER Lamp	On: Normal (green) Flashing: Circuit board or power supply failure			

- *1 Only for displaying "picture" images, 3D parts and video images. All other content is displayed using 65,536 colors.
- *2 Time until the surface brightness becomes 50 % of the initial value at an ambient temperature of 25 °C.

Touch Switch Specifications

Item	V9101iW	V9100iW	V9071iW	V9070iW
Type	Projected-capacitive type	Analog resistive film type	Projected-capacitive type	Analog resistive film type
Switch Resolution	-	1024 × 1024	-	1024 × 1024
Mechanical Life	-	One million activations or more	-	One million activations or more
Surface Treatment	Clear	Anti-glare treatment	Clear	Anti-glare treatment

Wireless LAN Specifications (Only for Wireless LAN I/F Models)

Item	Specification
Complying Antennas	Built-in antenna of the V9 series unit V9-ANT (optional): External dipole antenna for wireless LAN

* For details of other wireless LAN specifications, refer to page 3-22.

Interface Specifications

Item		Specification	
D-sub 9-pin (CN1) *1	Applicable standards	RS-232C, RS-485 (2-wire connection), RS-422 (4-wire connection)	
	Synchronization	Asynchronous type	
	Data Length	7 or 8 bits	
	Parity	None, even, odd	
	Stop Bit	1 or 2 bits	
	Baud Rate	4800, 9600, 19200, 38400, 57600, 76800, 115k bps (For PPI/MPI connection with a Siemens PLC: 187.5 kbps *2 *3)	
	Applications	PLC, temperature controller, barcode reader connection, etc.	
Modular Jack, 8-pin (MJ1, MJ2 *3)	Applicable standards	RS-232C, RS-485 (2-wire connection)	
	Applications	Screen program transfer (MJ1), PLC, temperature controller, barcode reader, printer, multi-link2, V-Link connection, etc.	
Modular Jack, 8-pin (MJ2 *4)	Applicable standards	RS-232C, RS-485 (2-wire connection), RS-422 (4-wire connection)	
	Baud Rate	4800, 9600, 19200, 38400, 57600, 76800, 115k bps (For PPI/MPI connection with a Siemens PLC: 187.5 kbps *2)	
	Applications	PLC, temperature controller, barcode reader connection, etc.	
USB Connector (U-A, U-B)	USB-A	Applicable standards	Compliant with USB version 2.0
		Baud Rate	High speed 480 Mbps
		Applications	Printer (EPSON ESC/P-R driver), USB flash drive, keyboard, mouse connection, etc.
	USB mini-B	Applicable standards	Compliant with USB version 2.0
		Baud Rate	High speed 480 Mbps
		Applications	Screen program transfer, PictBridge-compatible printer connection
Ethernet Port 100BASE-TX / 10BASE-T (LAN, LAN2)	Applicable standards	IEEE802.3u compliant (100BASE-TX), IEEE802.3 compliant (10BASE-T)	
	Baud Rate	100 Mbps, 10 Mbps	
	Protocol	TCP/IP, UDP/IP	
	Functions	Auto-MDIX, Auto-Negotiation	
	Recommended Cable *5	100 Ω UTP (unshielded twist-pair) cable, category 5, max. 100 m long	
	Applications	Screen program transfer, PLC connection, etc.	
Connector for Wireless LAN Dipole Antenna (WLAN) *6		Reverse polarity SMA jack	
SD Card Interface		SD/SDHC card compliant	
Communication Interface Unit Connector (EXT1)		Optional unit "DUR-00" *4 and communication interface unit "CUR-xx" (for SX-BUS, OPCN-1, T-Link, Ethernet, CC-Link, PROFIBUS-DP, DeviceNet, and FL-net) connection * The "DUR-00" and "CUR-xx" cannot be used at the same time.	
Connector for Optional Unit (EXT2) *3		Optional unit "GUR-xx" (for RGB input, RGB output, and video input) connection	
Audio Output Connector (AUDIO) *3		φ3.5 mm stereo mini jack	

*1 For the V907xiW, the optional "DUR-00" unit must be attached.

*2 For details, refer to the V9 Series Connection Manual 1.

*3 Only for V910xiW.

*4 Only for V907xiW.

*5 Both straight and cross cables are usable, irrespective of the presence or absence of a hub.

*6 Only for wireless LAN I/F models.

Clock and Backup Memory Specifications

Item	V910xiW	V907xiW
Battery	Coin-type lithium primary cell (V9-BT manufactured by Hakko Electronics or CR2450S manufactured by Sony Energy Devices)	Coin-type lithium primary cell (V7-BT manufactured by Hakko Electronics)
Backup Memory	SRAM 800 KB	
Backup Retention Period	Approx. 5 years (ambient temperature at 25 °C)	
Battery Voltage Drop Detection	Provided (allocated to internal device memory address \$s167)	
Calendar Accuracy *	When powered: Monthly deviation of ± 210 sec. (ambient temperature at 25 °C) When unpowered: Monthly deviation of ± 90 sec. (ambient temperature at 25 °C, with battery backup)	

* When using the unit at an ambient temperature other than 25 °C, clock deviation may increase. Check and correct the clock periodically.

Screen Configuration Environment

Item	Specification
Configuration Method	Dedicated configuration software
Configuration Tool	Name of dedicated configuration software: V-SFT-6 Computer: Pentium IV 2.0 GHz or above recommended OS *1: Windows XP/ XP64 Edition/ Vista(32bit,64bit) / 7 (32bit, 64bit) / 8 (32bit, 64bit) / 8.1 (32bit, 64bit) Memory: 1.0 GB or above (2.0 GB or above recommended) Hard disk capacity: Free space of approx. 2.0 GB or more Optical disc drive: DVD-ROM drive Display: Resolution of 1024 × 768 or above Color depth of 16-bit or above Other: Microsoft .NET Framework 4.0 or 4.5 (If a PC does not have .NET Framework 4.0 or 4.5 installed, Framework 4.0 will be automatically installed on the PC.)

*1 Administrator privileges are required for installation.

Display Function Specifications

Item	Specification	
Interface Language *1	Japanese, English/Western Europe, Chinese (Traditional), Chinese (Simplified), Korean, Central Europe, Cyrillic, Greek, Turkish, and Baltic	
Font Types	TrueType fonts, bitmap fonts, Windows fonts	
Character Properties	Display Properties	Normal, blink, bold, shadow, transparent, italic
	Colors	65,536 colors (without blinking) / 32,768 colors (with blinking)
Graphics	Lines	Line, continuous line, box, parallelogram, polygon
	Circles	Circle, arc, sector, ellipse, elliptical arc
	Others	Pattern, image, data display (graphics library, data sheets)
Graphic Properties	Line Types	6 types (thin, thick, dotted, chain, dashed, two-dot chain) Line thickness can be selected from 1 to 8 points (excluding thick lines).
	Tile Patterns	16 types (including 8 user-definable patterns)
	Display Properties	Normal, blinking
	Colors	65,536 colors (without blinking) / 32,768 colors (with blinking)
	Color Selection	Foreground, background, boundary (line)

*1 For more information, refer to V9 Series Reference Manual 1.

Function Performance Specifications

Item		Specification
Screens		Max. 4,000
Screen Memory		64 MB of flash memory
Switches		Max. 4,096 per screen ^{*1} (including slider switches and scroll bars)
Switch Actions		Set, reset, momentary, alternate, illuminated It is possible to press two switches on the display at the same time.
Lamps		Reverse, blinking, exchange of graphics Max. 4,096 per screen ^{*1}
Graphs		Pie, bar, panel meter and closed area graph: Max. 4,096 per screen ^{*1} Statistics and trend graphs: Max. 256 per layer ^{*2}
Data Setting	Numerical Data Display	Max. 4,096 per screen ^{*1}
	Character Display	Max. 4,096 per screen ^{*1}
	Message Display	Max. 4,096 per screen ^{*1} Maximum number of characters per line: 127 one-byte characters
Messages		Max. 32,768 lines
Macro Blocks		Max. 1,024
Graphics Library		Max. 2,560
Overlap Library		Max. 4,000
Screen Library		Max. 4,000
Data Blocks		Max. 1,024
Patterns		Max. 1,024
Data Sheets		Max. 1,024
Tags		Max. 65,536 lines
Page Blocks		Max. 2,048
Direct Blocks		Max. 1,024
Screen Blocks		Max. 1,024
Comments		Max. 32,767
Logging Server		Fixed cycle, trigger
Alarm Server		Real time, alarm, event
Recipes		Max. 256
Scheduler		Max. 64
MES Setting		Max. 256
Device Memory Map		Max. 32 × 8 (PLC1 to PLC8)
Time Display		Provided
Hard Copy		Provided
Buzzer		Provided, 3 sounds (short beep, long beep, continuous beep)
Auto OFF Function		Always ON, custom setting
Self-diagnostic Function		Touch switch test function ^{*3} Confirmation function that uses the status bar ^{*3} Network diagnostic functions (network test, duplicate IP address test) ^{*3}

*1 The maximum number of parts that can be placed on one screen is 4,096.

For more information on limitations regarding part placement, refer to the V9 Series Operation Manual.

*2 Layer: 11 layers per screen (base screen and 10 overlap displays)

*3 For more information, refer to the separate V9 Series Troubleshooting/Maintenance Manual.

V9101iW External Dimensions and Panel Cut-out Dimensions

- Front view

(Unit: mm)

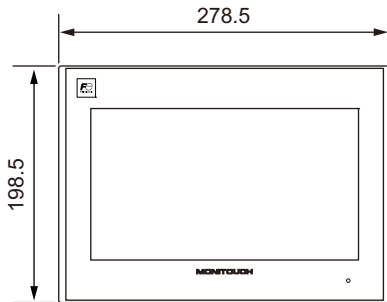

- Rear view

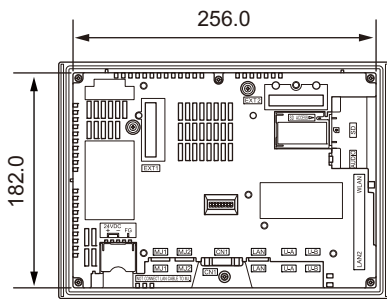

- Side view

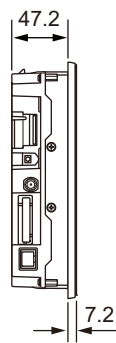

- Bottom view

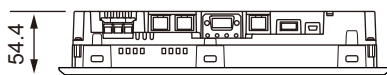

- Panel cut-out dimensions

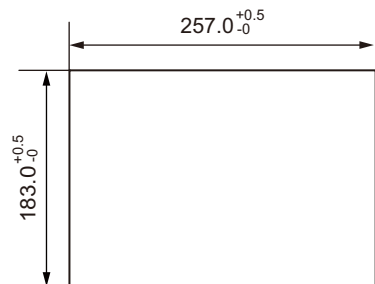

V9100iW External Dimensions and Panel Cut-out Dimensions

- Front view

(Unit: mm)

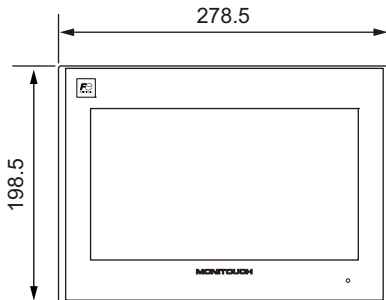

- Rear view

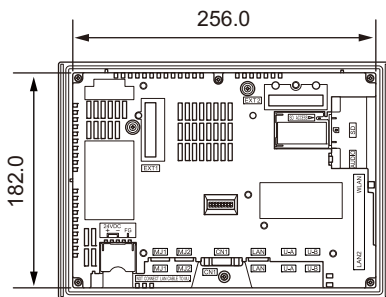

- Side view

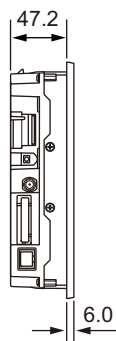

- Bottom view

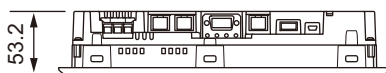

- Panel cut-out dimensions

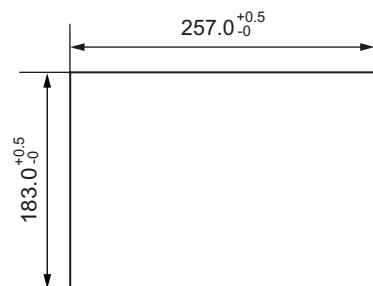

V9071iW External Dimensions and Panel Cut-out Dimensions

- Front view

(Unit: mm)

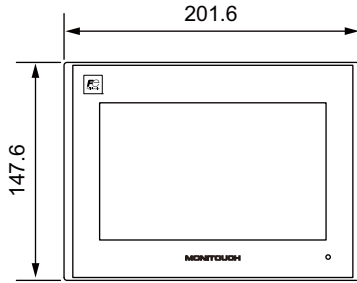

- Rear view

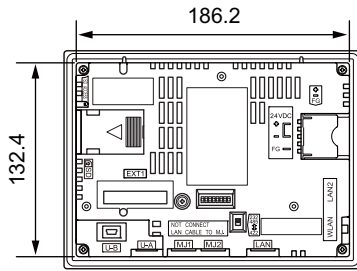

- Side view

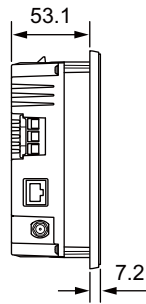

- Bottom view

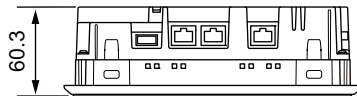

- Panel cut-out dimensions

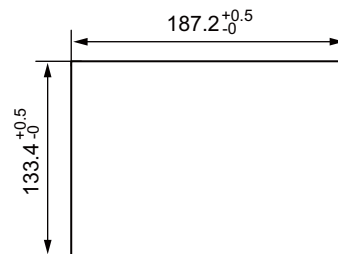

V9070iW External Dimensions and Panel Cut-out Dimensions

- Front view

(Unit: mm)

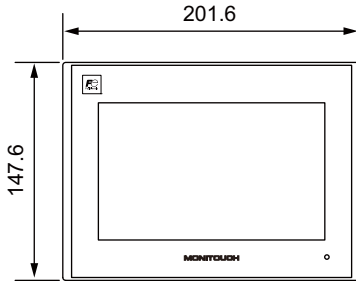

- Rear view

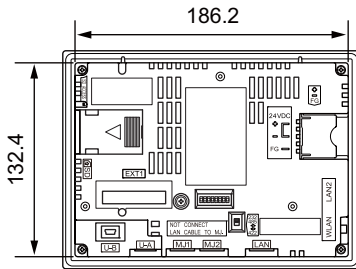

- Side view

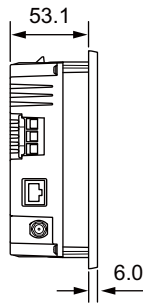

- Bottom view

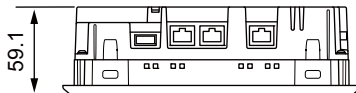

- Panel cut-out dimensions

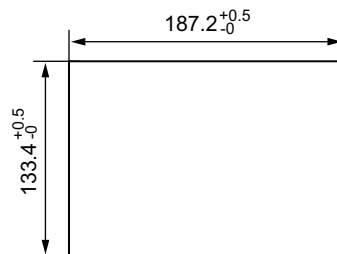

V907xiW with DUR-00 External Dimensions and Panel Cut-out Dimensions

- Front view

(Unit: mm)

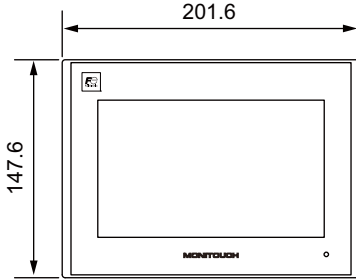

- Side view

V9071iW

V9070iW

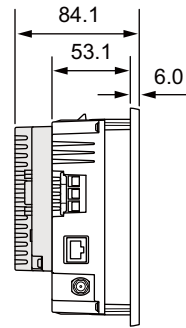
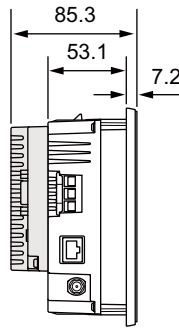

- Rear view

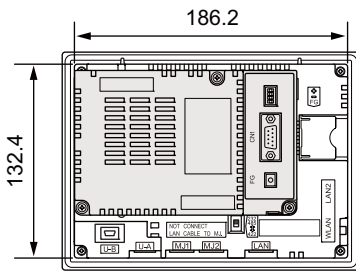

- Bottom view

V9071iW

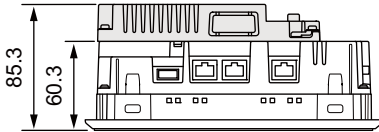

V9070iW

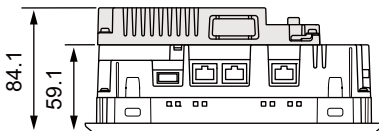

- Panel cut-out dimensions

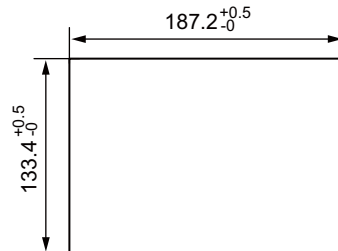

2. Standard Model

General Specifications

Item		V9150iX	V9150iXD	V9120iS	V9120iSD
Standards		KC	<ul style="list-style-type: none"> KC *1 CE (EN61000-6-2, EN61000-6-4) *1 UL508 (File No. E313548) Radio laws (Japan: TELEC) *3 	KC	<ul style="list-style-type: none"> KC *1 CE (EN61000-6-2, EN61000-6-4) *1 UL508 (File No. E313548) ANSI/ISA 12.12.01 (File No. E315977) *2 Radio laws (Japan: TELEC) *3
Power Supply	Permissible Voltage Range	100 to 240 VAC -15 % to +10 % (47 to 63 Hz)	24 VDC ± 10 %	100 to 240 VAC -15 % to +10 % (47 to 63 Hz)	24 VDC ± 10 %
	Permissible Momentary Power Failure	Within 20 ms (100 VAC or higher)	Within 1 ms	Within 20 ms (100 VAC or higher)	Within 1 ms
	Power Consumption (Max. Rating)	90 VA or less	40 W or less	70 VA or less	28 W or less
	Rush Current	30 A or less, 3 ms (ambient temperature at 25 °C)	19 A or less, 7 ms (ambient temperature at 25 °C)	30 A or less, 3 ms (ambient temperature at 25 °C)	18 A or less, 5 ms (ambient temperature at 25 °C)
	Withstand Voltage	AC external terminals to FG: 1,500 VAC for 1 minute, DC external terminals to FG: 500 VAC for 1 minute			
Insulation Resistance		AC external terminals to FG: 500 VDC at 10 MΩ or more, DC external terminals to FG: 500 VDC at 10 MΩ or more			
Physical Environment	Operational Ambient Temperature	0 °C to +40 °C *4		0 °C to +50 °C *4	
	Storage Ambient Temperature	-10 °C to +50 °C *4		-10 °C to +60 °C *4	
	Operational Ambient Humidity	85 % RH or less (without dew condensation) *4			
	Storage Ambient Humidity	85 % RH or less (without dew condensation) *4			
	Altitude	2000 m or less			
	Atmosphere	No corrosive gas, no excessive dust, and no conductive dust			
	Overvoltage Category *5	Category II			
	Contamination Level *6	Contamination level 2			
Mechanical Working Conditions	Vibration Resistance	JIS B 3502 (IEC61131-2) compliant Vibration frequency: 5 to 9 Hz Half-amplitude: 3.5 mm, Vibration frequency: 9 to 150 Hz Constant acceleration: 9.8 m/s ² (1 G), X, Y, and Z: 3 directions (10 times each)			
	Shock Resistance	JIS B 3502 (IEC61131-2) compliant Peak acceleration: 147 m/s ² (15 G), X, Y, and Z: 3 directions, 3 times each (18 times in total)			
Electrical Working Conditions	Noise Resistance	Noise voltage: 1500 Vp-p, Pulse width: 1 μs, Rising time: 1 ns (Measured using a noise simulator)	Noise voltage: 1000 Vp-p, Pulse width: 1 μs, Rising time: 1 ns (Measured using a noise simulator)	Noise voltage: 1500 Vp-p, Pulse width: 1 μs, Rising time: 1 ns (Measured using a noise simulator)	
	Static Electricity Discharge Resistance	Compliant with IEC61000-4-2, contact: 6 kV, air: 8 kV			

Item		V9150iX	V9150iXD	V9120iS	V9120iSD
Mounting Conditions	Weight	Approx. 4.7 kg		Approx. 2.5 kg	
	Dimensions W × H × D	382.8 × 312.8 × 80.8 mm		327.8 × 261.0 × 54.9 mm	
	Panel Cut-out Dimensions	369.4 ^{+0.5} × 299.4 ^{+0.5} mm		313.0 ^{+0.5} × 246.2 ^{+0.5} mm	
Case Color		Front: Silver; Rear: Light gray		Light gray	
Material		Front: Aluminum; Rear: PC resin		PC resin	

Item		V9100iS	V9100iSD	V9080iSD
Standards		KC	<ul style="list-style-type: none"> • KC^{*1} • CE (EN61000-6-2, EN61000-6-4) ^{*1} • UL508 (File No. E313548) • ANSI/ISA 12.12.01 (File No. E315977) ^{*2} • Radio laws (Japan: TELEC) ^{*3} 	
Power Supply	Permissible Voltage Range	100 to 240 VAC -15 % to +10 % (47 to 63 Hz)	24 VDC ± 10 %	
	Permissible Momentary Power Failure	Within 20 ms (100 VAC or higher)	Within 1 ms	
	Power Consumption (Max. Rating)	70 VA or less	28 W or less	
	Rush Current	30 A or less, 3 ms (ambient temperature at 25 °C)	17 A or less, 6 ms (ambient temperature at 25 °C)	
	Withstand Voltage	AC external terminals to FG: 1,500 VAC for 1 minute, DC external terminals to FG: 500 VAC for 1 minute		
Insulation Resistance		AC external terminals to FG: 500 VDC at 10 MΩ or more, DC external terminals to FG: 500 VDC at 10 MΩ or more		
Physical Environment	Operational Ambient Temperature	0 °C to +50 °C ^{*4}		
	Storage Ambient Temperature	-10 °C to +60 °C ^{*4}		
	Operational Ambient Humidity	85 % RH or less (without dew condensation) ^{*4}		
	Storage Ambient Humidity	85 % RH or less (without dew condensation) ^{*4}		
	Altitude	2000 m or less		
	Atmosphere	No corrosive gas, no excessive dust, and no conductive dust		
	Overvoltage Category ^{*5}	Category II		
	Contamination Level ^{*6}	Contamination level 2		
Mechanical Working Conditions	Vibration Resistance	JIS B 3502 (IEC61131-2) compliant Vibration frequency: 5 to 9 Hz Half-amplitude: 3.5 mm, Vibration frequency: 9 to 150 Hz Constant acceleration: 9.8 m/s ² (1 G), X, Y, and Z: 3 directions (10 times each)		
	Shock Resistance	JIS B 3502 (IEC61131-2) compliant Peak acceleration: 147 m/s ² (15 G), X, Y, and Z: 3 directions, 3 times each (18 times in total)		
Electrical Working Conditions	Noise Resistance	Noise voltage: 1500 Vp-p, Pulse width: 1 μs, Rising time: 1 ns (Measured using a noise simulator)		
	Static Electricity Discharge Resistance	Compliant with IEC61000-4-2, contact: 6 kV, air: 8 kV		
Mounting Conditions	Weight	Approx. 2.0 kg		Approx. 1.3 kg
	Dimensions W × H × D	303.8 × 231.0 × 54.0 mm		235.0 × 180.0 × 48.9 mm
	Panel Cut-out Dimensions	289.0 ^{+0.5} × 216.2 ^{+0.5} mm		220.5 ^{+0.5} × 165.5 ^{+0.5} mm

Item	V9100iS	V9100iSD	V9080iSD
Case Color	Light gray		
Material	PC resin		

- *1 Excluding models that support wireless LAN (V9150iXRD, V9120iSRD, V9100iSRD, V9080iSRD)
- *2 Only for V9120iSD, V9100iSD, V9080iSD.
- *3 Only models that support wireless LAN (V9150iXRD, V9120iSRD, V9100iSRD, V9080iSRD) are compliant with:
 - TELEC (Japanese Radio Law: Technical Regulations Conformity Certification, Article 2, clause 1-19)
The V9 series unit will not conform to the above laws if using any antenna other than the built-in antenna or the optional V9-ANT for wireless LAN connection.
- *4 Use the unit in an environment where the wet-bulb temperature is 39 °C or less, otherwise the unit may be damaged.
- *5 This indicates the distribution section to which the unit is intended to be connected to within the path between the distribution of the public power network and machinery in the facility.
"Category II" applies to devices supplied with power from mains sockets or similar points. The withstand surge voltage is 2,500 V for devices rated up to 300 V.
- *6 This is an index that expresses the degree of conductive contamination in the environment where the unit is used.
"Contamination level 2" indicates the condition where only non-conductive contamination occurs. However, due to condensation, temporary conductive contamination may occur.

Installation Specifications

Item		V9150iX	V9120iS/V9100iS/V9080iSD
Grounding		Less than 100 Ω, FG/SG connected	Less than 100 Ω, FG/SG separated
Protection Structure	Panel Front Surface ^{*1}	Complies with IP66, Type 4X/13 ^{*2} (when waterproof gasket is installed)	
	Rear Case	Equivalent to IP20	
Cooling System		Natural cooling	
Structure		Inserted in a mounting panel	
Appropriate Mounting Panel Thickness		1.5 to 4 mm ^{*3}	

- *1 Protective structure for the front when the V9 series unit is mounted on a mounting panel.
While the protective structure has passed compliance testing, it is not guaranteed under all environments.
- *2 Only for UL508 compliant models. Applies to V9120, V9100 and V9080 from hardware version b and later.
- *3 Even when the mounting panel thickness is within the specified range, the panel itself may warp depending on the material and size of the mounting panel.
Use a panel that can withstand the forces of mounting.

Display Specifications

Item	V9150iS	V9120iS	V9100iS	V9080iS
Display Device	TFT color			
Display Size	15.0-inch	12.1-inch	10.4-inch	8.4-inch
Colors	16.77 million colors ^{*1}			
Resolution (W × H)	1024 × 768 dots	800 × 600 dots		
Dot Pitch (W × H)	0.297 × 0.297 mm	0.3075 × 0.3075 mm	0.264 × 0.264 mm	0.213 × 0.213 mm
Actual Display Dimensions (W × H)	304.1 × 228.1 mm	246.0 × 184.5 mm	211.2 × 158.4 mm	170.4 × 127.8 mm
Backlight	LED			
Backlight Brightness Halftime ^{*2}	Approx. 100,000 hours	Approx. 70,000 hours		
Backlight Auto OFF Function	Always ON, custom setting			
Brightness Adjustment	System menu: 16 levels Macro: 128 levels			
Touch Panel Operation Surface	Surface sheet (PET, 0.188 mm)	Surface sheet (PC, 0.3 mm)	Surface sheet (PET, 0.188 mm)	
POWER Lamp	On: Normal (green) Flashing: Backlight, circuit board or power supply failure			

- *1 Only for displaying "picture" images, 3D parts and video images. All other content is displayed using 65,536 colors.
- *2 Time until the surface brightness becomes 50 % of the initial value at an ambient temperature of 25 °C.

Touch Switch Specifications

Item	Specification
Type	Analog resistance film type
Switch Resolution	1024 × 1024
Mechanical Life	One million activations or more
Surface Treatment	Anti-glare treatment

Wireless LAN Specifications (Only for Wireless LAN I/F Models)

Item	Specification
Complying Antennas	Built-in antenna of the V9 series unit V9-ANT (optional): External dipole antenna for wireless LAN

* For details of other wireless LAN specifications, refer to page 3-22.

Function Switch Specifications

Item	Specification
Number of Switches	8
Type	Membrane switch
Mechanical Life	One million activations or more

Interface Specifications

Item	Specification		
D-sub 9-pin (CN1)	Applicable Standards	RS-232C, RS-485 (2-wire connection), RS-422 (4-wire connection)	
	Synchronization	Asynchronous type	
	Data Length	7 or 8 bits	
	Parity	None, even, odd	
	Stop Bit	1 or 2 bits	
	Baud Rate	4800, 9600, 19200, 38400, 57600, 76800, 115 kbps (For PPI/MPI connection with a Siemens PLC: 187.5 kbps*1)	
	Applications	PLC, temperature controller, barcode reader connection, etc.	
Modular Jack, 8-pin (MJ1, MJ2)	Applicable Standards	RS-232C, RS-485 (2-wire connection)	
	Applications	Screen program transfer (MJ1), PLC, temperature controller, barcode reader, printer, multi-link2, V-Link connection, etc.	
USB Connector (U-A / U-B)	USB-A	Applicable Standards	Compliant with USB version 2.0
		Baud Rate	High speed 480 Mbps
		Applications	Printer (EPSON ESC/P-R driver), USB flash drive, keyboard, mouse connection, etc.
	USB mini-B	Applicable Standards	Compliant with USB version 2.0
		Baud Rate	High speed 480 Mbps
		Applications	Screen program transfer, PictBridge-compatible printer connection

Item		Specification
Ethernet Port 100BASE-TX / 10BASE-T (LAN / LAN2 *2)	Applicable Standards	IEEE802.3u compliant (100BASE-TX), IEEE802.3 compliant (10BASE-T)
	Baud Rate	10 Mbps, 100 Mbps
	Protocol	TCP/IP, UDP/IP
	Functions	Auto-MDIX, Auto-Negotiation
	Recommended Cable *3	100 Ω UTP (unshielded twist-pair) cable, category 5, max. 100 m long
	Applications	Screen program transfer, PLC connection, etc.
Connector for Wireless LAN Dipole Antenna (WLAN) *4	Reverse polarity SMA jack	
SD Card Interface	SD/SDHC card support	
Communication Interface Unit Connector (EXT1)	Communication interface unit "CUR-xx" (for SX-BUS, OPCN-1, T-Link, Ethernet, CC-Link, PROFIBUS-DP, DeviceNet, and FL-net) connection	
Connector for Optional Unit (EXT2)	Optional unit "GUR-xx" (for RGB input, RGB output, and video input) connection	
Audio Output Connector (AUDIO)	φ3.5 mm stereo mini jack	

*1 For details, refer to the V9 Series Connection Manual 1.

*2 Only for additional wired LAN I/F models.

*3 Both straight and cross cables are usable, irrespective of the presence or absence of a hub.

*4 Only for wireless LAN I/F models.

Clock and Backup Memory Specifications

Item	Specification
Battery	Coin-type lithium primary cell (V9-BT manufactured by Hakko Electronics or CR2450S manufactured by Sony Energy Devices)
Backup Memory	SRAM, 800 KB
Backup Retention Period	Approx. 5 years (ambient temperature at 25 °C)
Battery Voltage Drop Detection	Provided (allocated the internal device memory address \$s167)
Calendar Accuracy *	When powered: Monthly deviation of ±210 sec. (ambient temperature at 25 °C) When powered: Monthly deviation of ±90 sec. (ambient temperature at 25 °C, with battery backup)

* When using the unit at an ambient temperature other than 25 °C, clock deviation may increase. Check and correct the clock periodically.

Screen Configuration Environment

Item	Specification
Configuration Method	Dedicated configuration software
Configuration Tool	Name of dedicated configuration software: V-SFT-6 Computer: Pentium IV 2.0 GHz or above recommended OS *1: Windows XP/ XP64 Edition/ Vista (32 bit, 64 bit) / 7 (32 bit, 64 bit) / 8 (32 bit, 64 bit) / 8.1 (32 bit, 64 bit) Memory: 1.0 GB or above (2.0 GB or above recommended) Hard disk capacity: Free space of approx. 2.0 GB or more Optical disc drive: DVD-ROM drive Display: Resolution of 1024 × 768 or above Color depth of 16-bit or more Other: Microsoft .NET Framework 4.0 or 4.5 (If a PC does not have .NET Framework 4.0 or 4.5 installed, Framework 4.0 will be automatically installed on the PC.)

*1 Administrator privileges are required for installation.

Display Function Specifications

Item		Specification
Interface Language *1		Japanese, English/Western Europe, Chinese (Traditional), Chinese (Simplified), Korean, Central Europe, Cyrillic, Greek, Turkish, and Baltic
Font Types		TrueType fonts, bitmap fonts, Window fonts
Character Properties	Display Properties	Normal, blink, bold, shadow, transparent, italic
	Colors	65,536 colors (without blinking) / 32,768 colors (with blinking)
Graphics	Lines	Line, continuous line, box, parallelogram, polygon
	Circles	Circle, arc, sector, ellipse, elliptical arc
	Others	Pattern, image, data display (graphics library, data sheets)
Graphic Properties	Line Types	6 types (thin, thick, dotted, chain, dashed, two-dot chain) Line thickness can be selected from 1 to 8 points (excluding thick lines).
	Tile Patterns	16 types (including 8 user-definable patterns)
	Display Properties	Normal, blinking
	Colors	65,536 colors (without blinking) / 32,768 colors (with blinking)
	Color Selection	Foreground, background, boundary (line)

*1 For more information, refer to the V9 Series Reference Manual 1.

Function Performance Specifications

Item		Specification
Screens		Max. 4,000
Screen Memory		64 MB of flash memory
Switches		Max. 4,096 per screen ^{*1} (including slider switches and scroll bars)
Switch Actions		Set, reset, momentary, alternate, illuminated It is possible to press a function switch and a switch on the display at the same time.
Lamps		Reverse, blinking, exchange of graphics Max. 4,096 per screen
Graphs		Pie, bar, panel meter and closed area graph: Max. 4,096 per screen ^{*1} Statistics and trend graphs: Max. 256 per layer ^{*2}
Data Setting	Numerical Data Display	Max. 4,096 per screen ^{*1}
	Character Display	Max. 4,096 per screen ^{*1}
	Message Display	Max. 4,096 per screen ^{*1} Maximum number of characters per line: 100 one-byte characters
Messages		Max. 32,768 lines
Macro Blocks		Max. 1,024
Graphics Library		Max. 2,560
Overlap Library		Max. 4,000
Screen Library		Max. 4,000
Data Blocks		Max. 1,024
Patterns		Max. 1,024
Data Sheets		Max. 1,024
Tags		Max. 65,536 lines
Page Blocks		Max. 2,048
Direct Blocks		Max. 1,024
Screen Blocks		Max. 1,024
Comments		Max. 32,767
Logging Server		Fixed cycle, trigger
Alarm Server		Real time, alarm, event
Recipes		Max. 256
Scheduler		Max. 64
MES Setting		Max. 256
Device Memory Map		Max. 32 × 8 (PLC1 to PLC8)
Time Display		Provided
Hard Copy		Provided
Buzzer		Provided, 3 sounds (short beep, long beep, continuous beep)
Auto OFF Function		Always ON, custom setting
Self-diagnostic Function		Touch switch test function ^{*3} Confirmation function that uses the status bar ^{*3} Network diagnostic functions (network test, duplicate IP address test) ^{*3}

*1 The maximum number of parts that can be placed on one screen is 4,096.

For more information on limitations regarding part placement, refer to the V9 Series Operation Manual.

*2 Layer: 11 layers per screen (base + 10 overlap displays including global overlap)

*3 For more information, refer to the separate V9 Series Troubleshooting/Maintenance Manual.

V9150ix External Dimensions and Panel Cut-out Dimensions

- Front view

(Unit: mm)

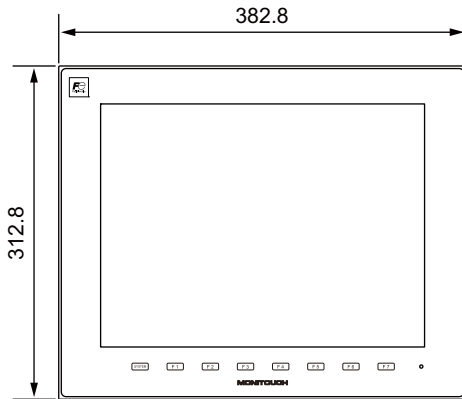

- Rear view

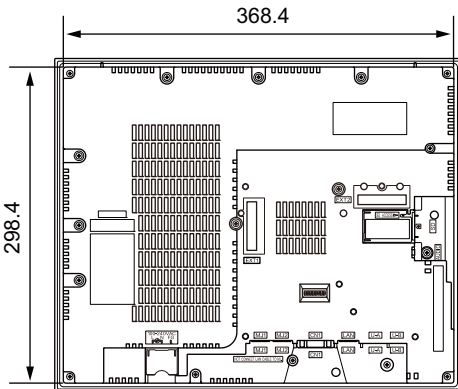

- Side view

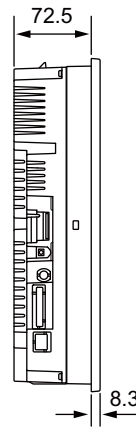

- Bottom view

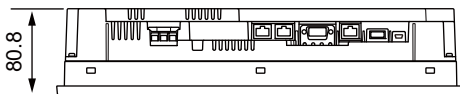

- Panel cut-out dimensions

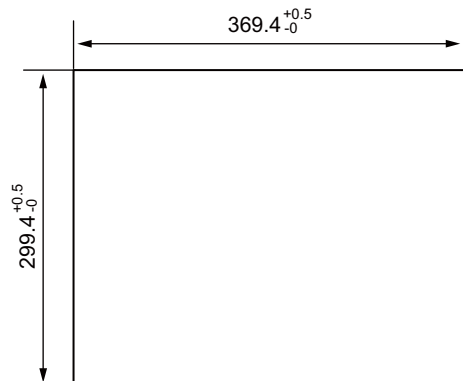

V9120iS External Dimensions and Panel Cut-out Dimensions

- Front view

(Unit: mm)

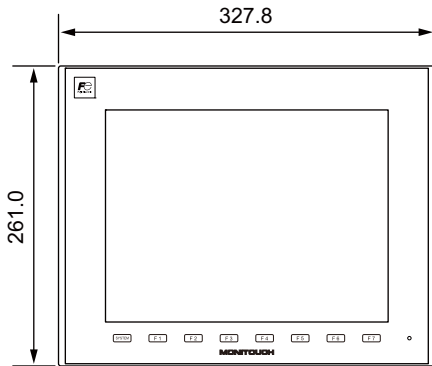

- Rear view

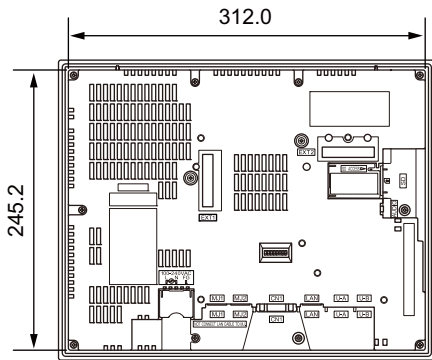

- Side view

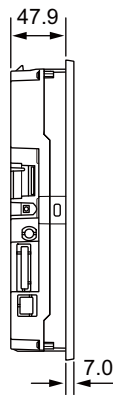

- Bottom view

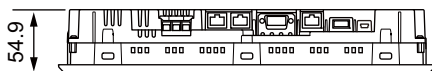

- Panel cut-out dimensions

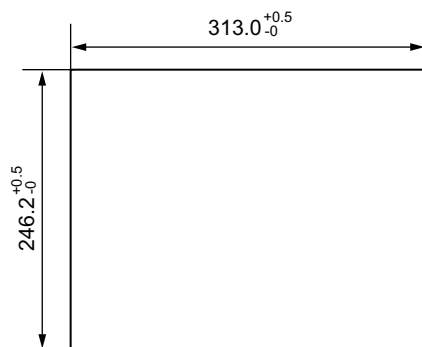

V9100iS External Dimensions and Panel Cut-out Dimensions

- Front view

(Unit: mm)

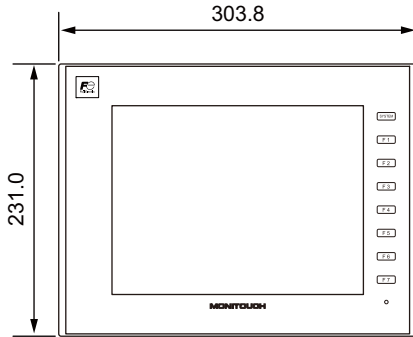

- Rear view

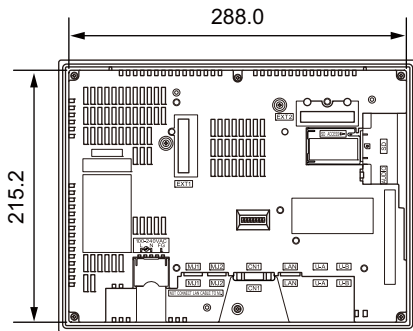

- Side view

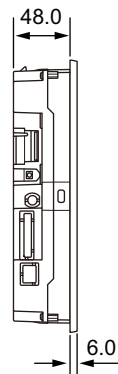

- Bottom view

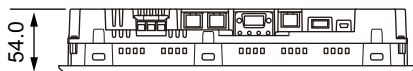

- Panel cut-out dimensions

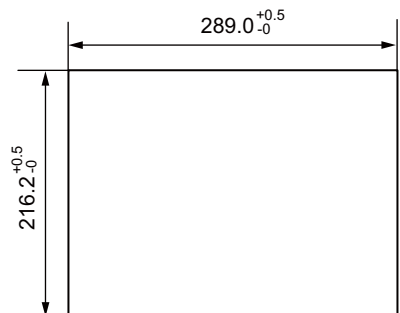

V91080iSD External Dimensions and Panel Cut-out Dimensions

- Front view

(Unit: mm)

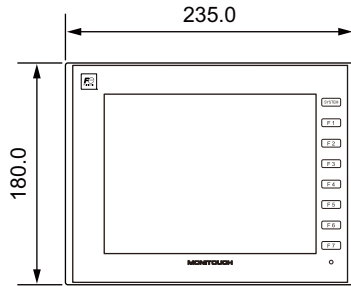

- Rear view

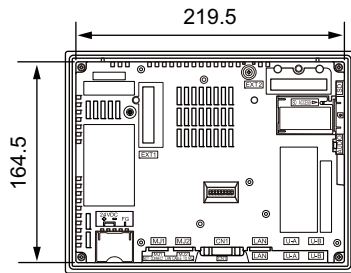

- Side view

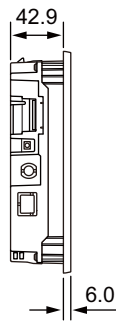

- Bottom view

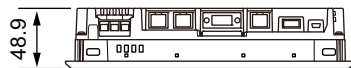

- Panel cut-out dimensions

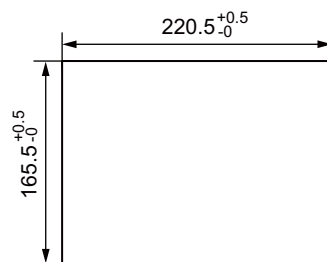

3. Lite Model

General Specifications

Item		V9100iC	V9100iCD	V9080iCD	V9060iTD
Standards		KC	<ul style="list-style-type: none"> KC CE (EN61000-6-2, EN61000-6-4) UL508 (File No. E313548) 		<ul style="list-style-type: none"> KC CE (EN61000-6-2, EN61000-6-4) UL508 (File No. E313548) ANSI/ISA 12.12.01 (File No. E315977)
Power Supply	Permissible Voltage Range	100 to 240 VAC -15 % to +10 % (47 to 63 Hz)	24 VDC \pm 10 %		
	Permissible Momentary Power Failure	Within 20 ms (100 VAC or higher)	Within 1 ms		
	Power Consumption (Max. Rating)	50 VA or less	17 W or less		13 W or less
	Rush Current	30 A or less, 3 ms (ambient temperature at 25 °C)	17 A or less, 6 ms (ambient temperature at 25 °C)		8 A or less, 7 ms (ambient temperature at 25 °C)
	Withstand Voltage	AC external terminals to FG: 1,500 VAC for 1 minute, DC external terminals to FG: 500 VAC for 1 minute			
Insulation Resistance		AC external terminals to FG: 500 VDC at 10 M Ω or more, DC external terminals to FG: 500 VDC at 10 M Ω or more			
Physical Environment	Operational Ambient Temperature	0 °C to +50 °C *1			
	Storage Ambient Temperature	-10 °C to +60 °C *1			
	Operational Ambient Humidity	85 % RH or less (without dew condensation) *1			
	Storage Ambient Humidity	85 % RH or less (without dew condensation) *1			
	Altitude	2000 m or less			
	Atmosphere	No corrosive gas, no excessive dust, and no conductive dust			
	Overvoltage Category *2	Category II			
	Contamination Level *3	Contamination level 2			
Mechanical Working Conditions	Vibration Resistance	JIS B 3502 (IEC61131-2) compliant Vibration frequency: 5 to 9 Hz Half-amplitude: 3.5 mm, Vibration frequency: 9 to 150 Hz Constant acceleration: 9.8 m/s ² (1 G), X, Y, and Z: 3 directions (10 times each)			
	Shock Resistance	JIS B 3502 (IEC61131-2) compliant Peak acceleration: 147 m/s ² (15 G), X, Y, and Z: 3 directions, 3 times each (18 times in total)			
Electrical Working Conditions	Noise Resistance	Noise voltage: 1500 Vp-p, Pulse width: 1 μ s, Rising time: 1 ns (Measured using a noise simulator)		Noise voltage: 1000 Vp-p, Pulse width: 1 μ s, Rising time: 1 ns (Measured using a noise simulator)	
	Static Electricity Discharge Resistance	Compliant with IEC61000-4-2, contact: 6 kV, air: 8 kV			
Mounting Conditions	Weight	Approx. 2.0 kg		Approx. 1.3 kg	Approx. 740 g
	Dimensions W \times H \times D	303.8 \times 231.0 \times 54.0 mm		235.0 \times 180.0 \times 48.9 mm	182.5 \times 138.8 \times 53.0 mm
	Panel Cut-out Dimensions	289.0 ^{+0.5} ₋₀ \times 216.2 ^{+0.5} ₋₀ mm		220.5 ^{+0.5} ₋₀ \times 165.5 ^{+0.5} ₋₀ mm	174.0 ^{+0.5} ₋₀ \times 131.0 ^{+0.5} ₋₀ mm

Item	V9100iC	V9100iCD	V9080iCD	V9060iTD
Case Color	Light gray			
Material	PC resin			

- *1 Use the unit in an environment where the wet-bulb temperature is 39 °C or less, otherwise the unit may be damaged.
- *2 This indicates the distribution section to which the unit is intended to be connected to within the path between the distribution of the public power network and machinery in the facility.
"Category II" applies to devices supplied with power from mains sockets or similar points. The withstand surge voltage is 2,500 V for devices rated up to 300 V.
- *3 This is an index that expresses the degree of conductive contamination in the environment where the unit is used.
"Contamination level 2" indicates the condition where only non-conductive contamination occurs. However, due to condensation, temporary conductive contamination may occur.

Installation Specifications

Item		V9100iC	V9100iCD/V9080iCD/V9060iTD
Grounding		Less than 100 Ω, FG/SG separated	
Protection Structure	Panel Front Surface *1	Complies with IP66 (when waterproof gasket is installed)	Complies with IP66, Type 4X/13 *2 (when waterproof gasket is installed)
	Rear Case	Equivalent to IP20	
Cooling System		Natural cooling	
Structure		Inserted in a mounting panel	
Appropriate Mounting Panel Thickness		1.5 to 4 mm *3	

*1 Protective structure for the front when the V9 series unit is mounted on a mounting panel.

While the protective structure has passed compliance testing, it is not guaranteed under all environments.

*2 Applies to V9100 and V9080 from hardware version b and later.

*3 Even when the mounting panel thickness is within the specified range, the panel itself may warp depending on the material and size of the mounting panel.

Use a panel that can withstand the forces of mounting.

Display Specifications

Item	V9100iC	V9080iC	V9060iTD
Display Device	TFT color		
Display Size	10.4-inch	8.4-inch	5.7-inch
Colors	16.77 million colors *1		262 thousand colors
Resolution (W × H)	640 × 480 dots		
Dot Pitch (W × H)	0.33 × 0.33 mm	0.267 × 0.267 mm	0.18 × 0.18 mm
Actual Display Dimensions (W × H)	211.2 × 158.4 mm	170.88 × 128.16 mm	115.2 × 86.4 mm
Backlight	LED		
Backlight Brightness Halftime *2	Approx. 70,000 hours		Approx. 50,000 hours
Backlight Auto OFF Function	Always ON, custom setting		
Brightness Adjustment	System menu: 16 levels Macro: 128 levels		
Touch Panel Operation Surface	Surface sheet (PET, 0.188 mm)		
POWER Lamp	On: Normal (green) Flashing: Backlight, circuit board or power supply failure		

*1 Only for displaying "picture" images and 3D parts. All other content is displayed using 65,536 colors.

*2 Time until the surface brightness becomes 50 % of the initial value at an ambient temperature of 25 °C.

Touch Switch Specifications

Item	Specification
Type	Analog resistance film type
Switch Resolution	1024 × 1024
Mechanical Life	One million activations or more
Surface Treatment	Anti-glare treatment

Function Switch Specifications

Item	V9100iC/V9080iCD	V9060iTD
Number of Switches	8	6
Type	Membrane switch	
Mechanical Life	One million activations or more	

Interface Specifications

Item	Specification		
D-sub 9-pin (CN1)	Applicable Standards	RS-232C, RS-485 (2-wire connection), RS-422 (4-wire connection)	
	Synchronization	Asynchronous type	
	Data Length	7 or 8 bits	
	Parity	None, even, odd	
	Stop Bit	1 or 2 bits	
	Baud Rate	4800, 9600, 19200, 38400, 57600, 76800 bps, 115 kbps (For PPI/MPI connection with a Siemens PLC: 187.5 kbps * ³)	
Applications	PLC, temperature controller, barcode reader connection, etc.		
Modular Jack, 8-pin (MJ1, MJ2 * ³)	Applicable Standards	RS-232C, RS-485 (2-wire connection)	
	Applications	Screen program transfer (MJ1), PLC, temperature controller, barcode reader, printer, multi-link2, V-Link connection, etc.	
Modular Jack, 8-pin (MJ2 * ⁴)	Applicable standards	RS-232C, RS-485 (2-wire connection), RS-422 (4-wire connection)	
	Baud Rate	4800, 9600, 19200, 38400, 57600, 76800, 115k bps (For PPI/MPI connection with a Siemens PLC: 187.5 kbps * ²)	
	Applications	PLC, temperature controller, barcode reader connection, etc.	
USB Connector (U-A / U-B)	USB-A	Applicable Standards	Compliant with USB version 2.0
		Baud Rate	High speed 480 Mbps
		Applications	Printer (EPSON ESC/P-R driver), USB flash drive, keyboard, mouse connection, etc.
	USB mini-B	Applicable Standards	Compliant with USB version 2.0
		Baud Rate	High speed 480 Mbps
		Applications	Screen program transfer, PictBridge-compatible printer connection
Ethernet Port 100BASE-TX / 10BASE-T (LAN)	Applicable Standards	IEEE802.3u compliant (100BASE-TX), IEEE802.3 compliant (10BASE-T)	
	Baud Rate	10 Mbps, 100 Mbps	
	Protocol	TCP/IP, UDP/IP	
	Functions	Auto-MDIX, Auto-Negotiation	
	Recommended Cable * ⁵	100 Ω UTP (unshielded twist-pair) cable, category 5, max. 100 m long	
	Applications	Screen program transfer, PLC connection, etc.	
SD Card Interface	SD/SDHC card support		
Communication Interface Unit Connector (EXT1)	Optional unit "DUR-00" * ⁴ and communication interface unit "CUR-xx" (for SX-BUS, OPCN-1, T-Link, Ethernet, CC-Link, PROFIBUS-DP, DeviceNet, and FL-net) connection * The "DUR-00" and "CUR-xx" cannot be used at the same time.		

*1 For the V9060iTD, the optional "DUR-00" unit must be attached.

*2 For details, refer to V9 Series Connection Manual 1.

*3 Only for V9100iC and V9080iCD.

*4 Only for V9060iTD.

*5 Both straight and cross cables are usable, irrespective of the presence or absence of a hub.

Clock and Backup Memory Specifications

Item	V9100iC/V9080iCD	V9060iTD
Battery	Coin-type lithium primary cell (V9-BT manufactured by Hakko Electronics or CR2450S manufactured by Sony Energy Devices)	Coin-type lithium primary cell (V7-BT manufactured by Hakko Electronics)
Backup Memory	SRAM, 800 KB	
Backup Retention Period	Approx. 5 years (ambient temperature at 25 °C)	
Battery Voltage Drop Detection	Provided (allocated the internal device memory address \$S167)	
Calendar Accuracy *	When powered: Monthly deviation of ± 210 sec. (ambient temperature at 25 °C) When unpowered: Monthly deviation of ± 90 sec. (ambient temperature at 25 °C, with battery backup)	

* When using the unit at an ambient temperature other than 25 °C, clock deviation may increase. Check and correct the clock periodically.

Screen Configuration Environment

Item	Specification
Configuration Method	Dedicated configuration software
Configuration tool	Name of exclusive configuration software: V-SFT-6 Computer: Pentium IV 2.0 GHz or above recommended OS *1: Windows XP / XP64 Edition / Vista (32 bit, 64 bit) / 7 (32 bit, 64 bit) / 8 (32 bit, 64 bit) / 8.1 (32 bit, 64 bit) Memory: 1.0 GB or above (2.0 GB or above recommended) Hard disk capacity: Free space of approx. 2.0 GB or more Optical disc drive: DVD-ROM drive Display: Resolution 1024 × 768 or above Color depth of 16-bit or more Other: Microsoft .NET Framework 4.0 or 4.5 (If a PC does not have .NET Framework 4.0 or 4.5 installed, Framework 4.0 will be automatically installed on the PC.)

*1 Administrator privileges are required for installation.

Display Function Specifications

Item	Specification	
Interface Language *1	Japanese, English/Western Europe, Chinese (Traditional), Chinese (Simplified), Korean, Central Europe, Cyrillic, Greek, Turkish, and Baltic	
Font Types	TrueType fonts, bitmap fonts, Window fonts	
Character Properties	Display Properties	Normal, blink, bold, shadow, transparent
	Colors	65,536 colors (without blinking) / 32,768 colors (with blinking)
Graphics	Lines	Line, continuous line, box, parallelogram, polygon
	Circles	Circle, arc, sector, ellipse, elliptical arc
	Others	Pattern, image, data display (graphics library, data sheets)
Graphic Properties	Line Types	6 types (thin, thick, dotted, chain, dashed, two-dot chain) Line thickness can be selected from 1 to 8 points (excluding thick lines).
	Tile Patterns	16 types (including 8 user-definable patterns)
	Display Properties	Normal, blink
	Colors	65,536 colors (without blinking) / 32,768 colors (with blinking)
	Color Selection	Foreground, background, boundary (line)

*1 For more information, refer to the V9 Series Reference Manual 1.

Function Performance Specifications

Item		Specification
Screens		Max. 4,000
Screen Memory		64 MB of flash memory
Switches		Max. 4,096 per screen ^{*1} (including slider switches and scroll bars)
Switch Actions		Set, reset, momentary, alternate, illuminated It is possible to press a function switch and a switch on the display at the same time.
Lamps		Reverse, blinking, exchange of graphics Max. 4,096 per screen
Graphs		Pie, bar, panel meter and closed area graph: Max. 4,096 per screen ^{*1} Statistics and trend graphs: Max. 256 per layer ^{*2}
Data Setting	Numerical Data Display	Max. 4,096 per screen ^{*1}
	Character Display	Max. 4,096 per screen ^{*1}
	Message Display	Max. 4,096 per screen ^{*1} Maximum number of characters per line: 80 one-byte characters
Messages		Max. 32,768 lines
Macro Blocks		Max. 1,024
Graphics Library		Max. 2,560
Overlap Library		Max. 4,000
Screen Library		Max. 4,000
Data Blocks		Max. 1,024
Patterns		Max. 1,024
Data Sheets		Max. 1,024
Tags		Max. 65,536 lines
Page Blocks		Max. 2,048
Direct Blocks		Max. 1,024
Screen Blocks		Max. 1,024
Comments		Max. 32,767
Logging Server		Fixed cycle, trigger
Alarm Server		Real time, alarm, event
Recipes		Max. 256
Scheduler		Max. 64
MES Setting		Max. 256
Device Memory Map		Max. 32 × 8 (PLC1 to PLC8)
Time Display		Provided
Hard Copy		Provided
Buzzer		Provided, 3 sounds (short beep, long beep, continuous beep)
Auto OFF Function		Always ON, custom setting
Self-diagnostic Function		Touch switch test function ^{*3} Confirmation function that uses the status bar ^{*3} Network diagnostic functions (network test, duplicate IP address test) ^{*3}

*1 The maximum number of parts that can be placed on one screen is 4,096.

For more information on limitations regarding part placement, refer to the V9 Series Operation Manual.

*2 Layer: 11 layers per screen (base + 10 overlap displays including global overlap)

*3 For more information, refer to the separate V9 Series Troubleshooting/Maintenance Manual.

V9100iC External Dimensions and Panel Cut-out Dimensions

- Front view

(Unit: mm)

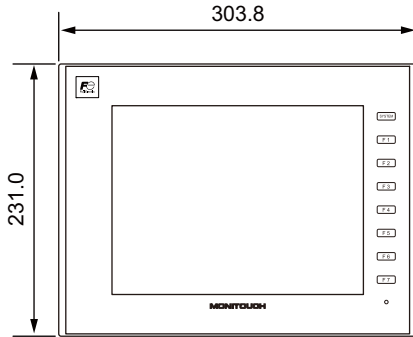

- Rear view

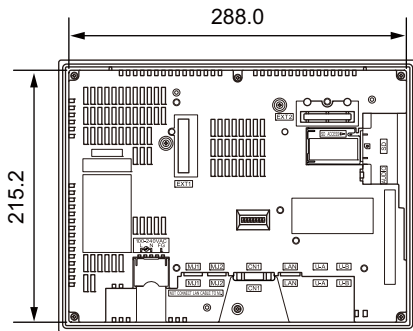

- Side view

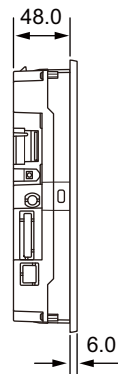

- Bottom view

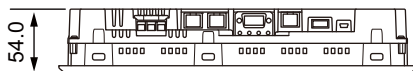

- Panel cut-out dimensions

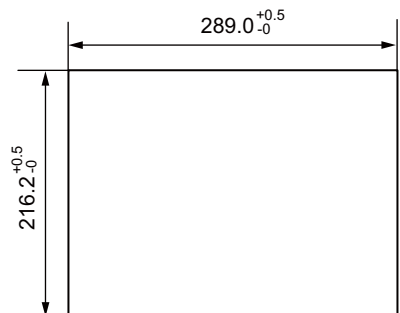

V9080iCD External Dimensions and Panel Cut-out Dimensions

- Front view

(Unit: mm)

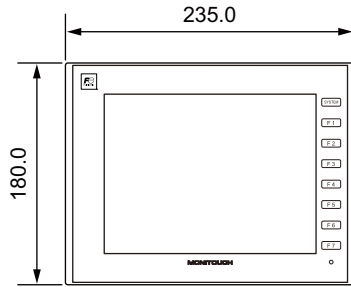

- Rear view

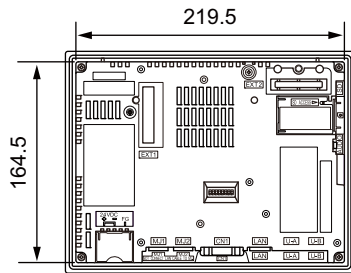

- Side view

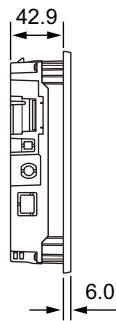

- Bottom view

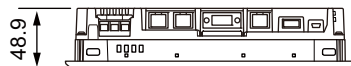

- Panel cut-out dimensions

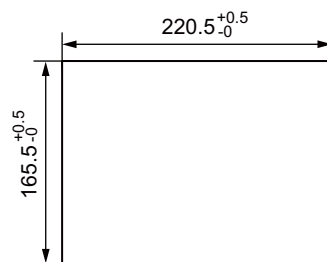

V9060iTD External Dimensions and Panel Cut-out Dimensions

- Front view

(Unit: mm)

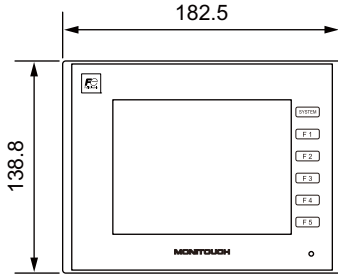

- Rear view

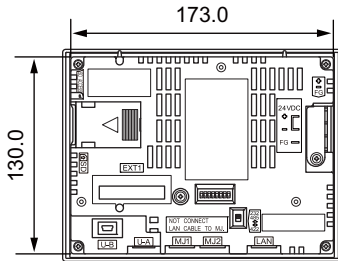

- Side view

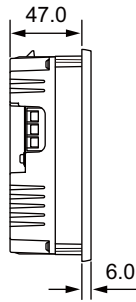

- Bottom view

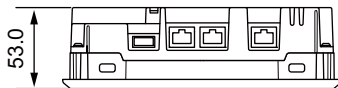

- Panel cut-out dimensions

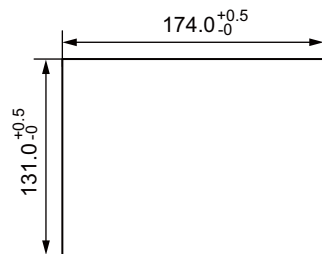

MEMO

Please use this page freely.

3 Names and Specifications of Components

1. Names and Functions of Components
2. Specifications of Components

1. Names and Functions of Components

Advanced Model

V910xiW

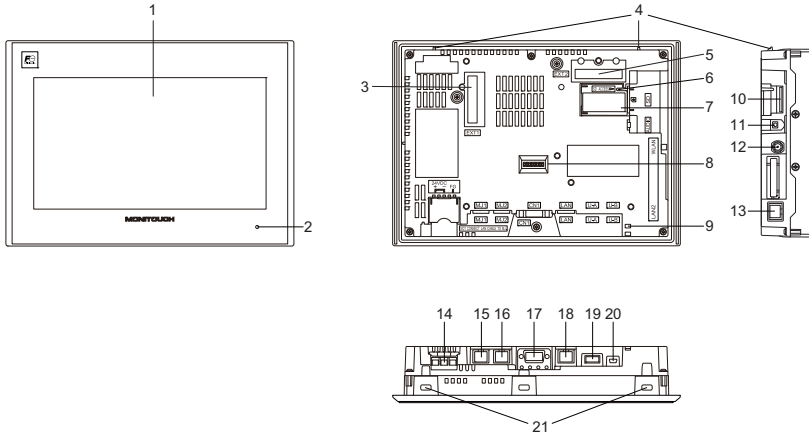

1. Display
This is the display area.
2. POWER lamp
This lamp illuminates green when the V9 series is powered ON and operating normally. The lamp flashes when there is a failure (circuit board failure, power supply failure).
3. Communication interface unit connector (EXT1)
This connector is used to connect any "CUR-xx" communication interface unit (for SX-BUS, OPCN-1, T-Link, CC-Link, Ethernet, PROFIBUS-DP, DeviceNet, and FL-net).
4. Fall prevention tabs
These tabs prevent the V9 series unit from falling off the mounting panel until the mounting fixtures are tightened.
5. Connector for optional unit (EXT2)
This connector is used to connect each optional "GUR-xx" unit (for video input, RGB input, and RGB output).
6. SD card access LED
This LED flashes when the unit is reading from or writing to an SD card.
7. Battery holder
This part contains the backup battery for the SRAM and clock. When the battery voltage drops, replace the battery with a new one.
8. DIP switches
This 8-bit DIP switch is used for setting the terminating resistance of the CN1 signal line and the MJ1/MJ2 RS-485 signal line.
9. USB cable clamp hole
This clamp hole is used to attach a USB cable tie.
10. SD card slot (SD)
This slot is where an SD card can be inserted.
11. Audio output connector (AUDIO)
This terminal is used for audio output.

12. Connector for wireless LAN dipole antenna (WLAN)
Only for wireless LAN I/F models.
This connector is for connecting the external dipole antenna "V9-ANT" (optional) for wireless LAN.
13. 100BASE-TX/10BASE-T connector (LAN2)
This connector is used for Ethernet communication.
14. Power supply terminal block
This terminal block is for supplying power (24 VDC) to the V9 series unit.
15. Modular jack 1 (MJ1)
This connector is used for screen program transfer and connection with PLCs or other peripheral devices.
16. Modular jack 2 (MJ2)
This connector is used for connection with PLCs or other peripheral devices.
17. PLC communication connector (CN1)
This connector is used for connection to a controller (PLC, temperature controller, inverter, etc.).
18. 100BASE-TX/10BASE-T connector (LAN)
This connector is used for Ethernet communication.
19. USB-A (U-A)
This port is used to connect a printer, USB flash drive, keyboard, or mouse.
20. USB mini-B (U-B)
This port is used for transferring screen programs or connecting a PictBridge-compatible printer.
21. Mounting holes
The mounting holes are used for inserting fixtures when securing the V9 series unit to a mounting panel.

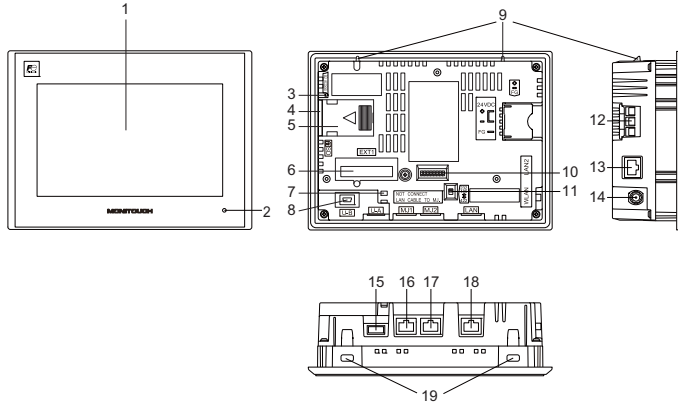
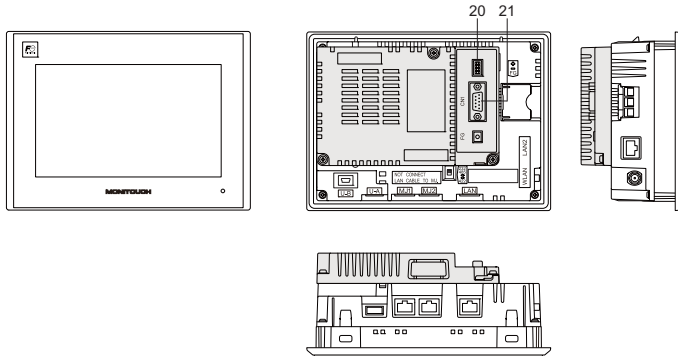
V907xiW**V907xiW+DUR-00**

1. Display
This is the display area.
2. POWER lamp
This lamp illuminates green when the V9 series is powered ON and operating normally. The lamp flashes when there is a failure (circuit board failure, power supply failure).
3. SD card access LED
This LED flashes when the unit is reading from or writing to an SD card.
4. SD card slot (SD)
This slot is where an SD card can be inserted.
5. Battery holder
This part contains the backup battery for the SRAM and clock. When the battery voltage drops, replace the battery with a new one.
6. Communication interface unit connector (EXT1)
This connector is used to connect the optional "DUR-00" unit or any "CUR-xx" communication interface unit (for SX-BUS, OPCN-1, T-Link, CC-Link, Ethernet, PROFIBUS-DP, DeviceNet, and FL-net).
* The "DUR-00" and "CUR-xx" cannot be used at the same time.
7. USB cable clamp hole
This clamp hole is used to attach a USB cable tie.
8. USB mini-B (U-B)
This port is used for transferring screen programs or connecting a PictBridge-compatible printer.

9. Fall prevention tabs
These tabs prevent the V9 series unit from falling off the mounting panel until the mounting fixtures are tightened.
10. DIP switches
This 8-bit DIP switch is used for setting the terminating resistance of the MJ1/MJ2 RS-485 signal line.
11. Sliding switch
This switch is for selecting the RS-232C/RS-485 signal (2-wire connection) or the RS-422 signal (4-wire connection) for MJ2. The upper side is for the RS-232C/RS-485 signal (2-wire connection) and the lower side is for the RS-422 signal (4-wire connection).
12. Power supply terminal block
This terminal block is for supplying power (24 VDC) to the V9 series unit.
13. 100BASE-TX/10BASE-T connector (LAN2)
This connector is used for Ethernet communication.
14. Connector for wireless LAN dipole antenna (WLAN)
Only for wireless LAN I/F models.
This connector is for connecting the external dipole antenna "V9-ANT" (optional) for wireless LAN.
15. USB-A (U-A)
This port is used to connect a printer, USB flash drive, keyboard, or mouse.
16. Modular jack 1 (MJ1)
This connector is used for screen program transfer and connection with PLCs or other peripheral devices.
17. Modular jack 2 (MJ2)
This connector is used for connection with PLCs or other peripheral devices.
18. 100BASE-TX/10BASE-T connector (LAN)
This connector is used for Ethernet communication.
19. Mounting holes
The mounting holes are used for inserting fixtures when securing the V9 series unit to a mounting panel.
20. DIP switches (optional "DUR-00" unit)
These switches are used for setting the terminating resistance of the CN1 signal line.
21. PLC communication connector (CN1) (optional "DUR-00" unit)
This connector is used for connection to a controller (PLC, temperature controller, inverter, etc.).

Standard Model

V9150iX

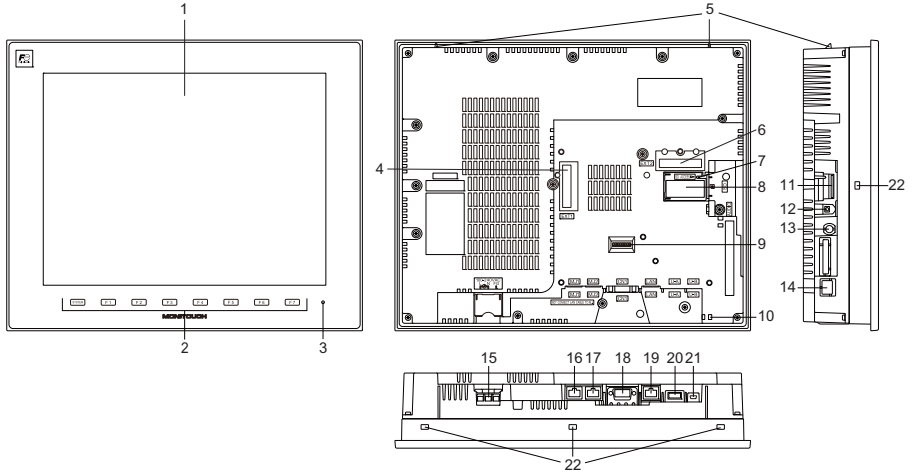

V9120iS

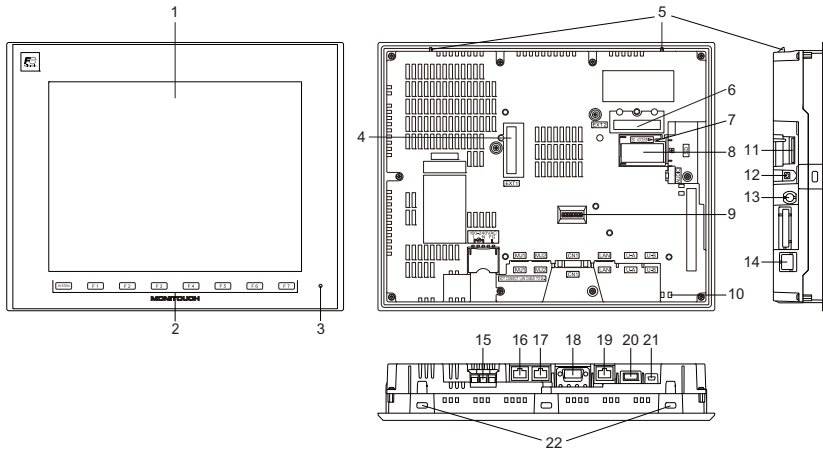

V9100iS

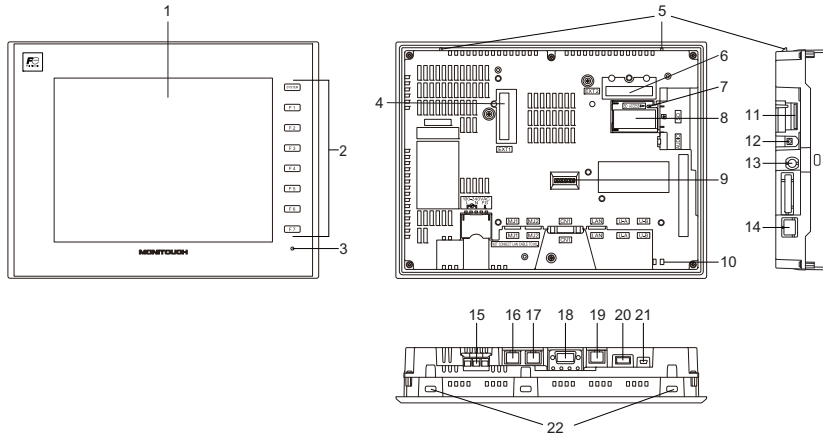

V9080iSD

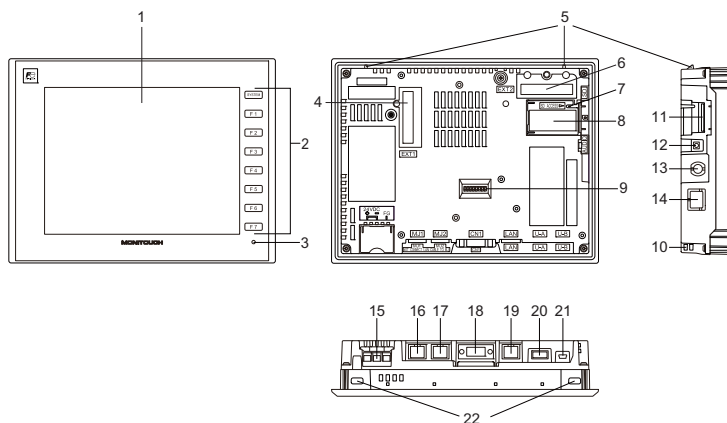

1. Display
This is the display area.
2. Function switches
There are 8 function switches comprising the [SYSTEM] switch and [F1] to [F7] switches. The [SYSTEM] switch is used to display or hide the system menu (for switching between the RUN and Local modes, adjusting brightness, etc.). Switches [F1] to [F7] can be used as user switches in RUN mode.
3. POWER lamp
This lamp illuminates green when the V9 series is powered ON and operating normally. The lamp flashes when there is a failure (backlight failure, circuit board failure, power supply failure).
4. Communication interface unit connector (EXT1)
This connector is used to connect any "CUR-xx" communication interface unit (for SX-BUS, OPCN-1, T-Link, CC-Link, Ethernet, PROFIBUS-DP, DeviceNet, and FL-net).
5. Fall prevention tabs
These tabs prevent the V9 series unit from falling off the mounting panel until the mounting fixtures are tightened.
6. Connector for optional unit (EXT2)
This connector is used to connect each optional "GUR-xx" unit (for video input, RGB input, and RGB output).
7. SD card access LED
This LED flashes when the unit is reading from or writing to an SD card.
8. Battery holder
This part contains the backup battery for the SRAM and clock. When the battery voltage drops, replace the battery with a new one.
9. DIP switches
This 8-bit DIP switch is used for setting the terminating resistance of the CN1 signal line and the MJ1/MJ2 RS-485 signal line.
10. USB cable clamp hole
This clamp hole is used to attach a USB cable tie.
11. SD card slot (SD)
This slot is where an SD card can be inserted.
12. Audio output connector (AUDIO)
This terminal is used for audio output.
13. Connector for wireless LAN dipole antenna (WLAN)
Only for wireless LAN I/F models.
This connector is for connecting the external dipole antenna "V9-ANT" (optional) for wireless LAN.

14. 100BASE-TX/10BASE-T connector (LAN2)
Only for additional wired LAN I/F models.
This connector is used for Ethernet communication.
15. Power supply terminal block
This terminal block supplies power to the V9 series unit (100 to 240 VAC, 24 VDC).
16. Modular jack 1 (MJ1)
This connector is used for screen program transfer and connection with PLCs or other peripheral devices.
17. Modular jack 2 (MJ2)
This connector is used for connection with PLCs or other peripheral devices.
18. PLC communication connector (CN1)
This connector is used for connection to a controller (PLC, temperature controller, inverter, etc.).
19. 100BASE-TX/10BASE-T connector (LAN)
This connector is used for Ethernet connection.
20. USB-A (U-A)
This port is used to connect a printer, USB flash drive, keyboard, or mouse.
21. USB mini-B (U-B)
This port is used for transferring screen programs or connecting a PictBridge-compatible printer.
22. Mounting holes
The mounting holes are used for inserting fixtures when securing the V9 series unit to a mounting panel.

Lite Model

V9100iC

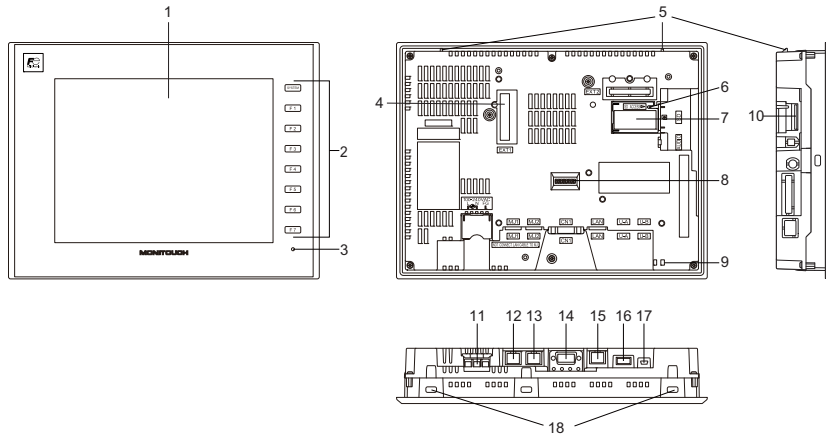

V9080iCD

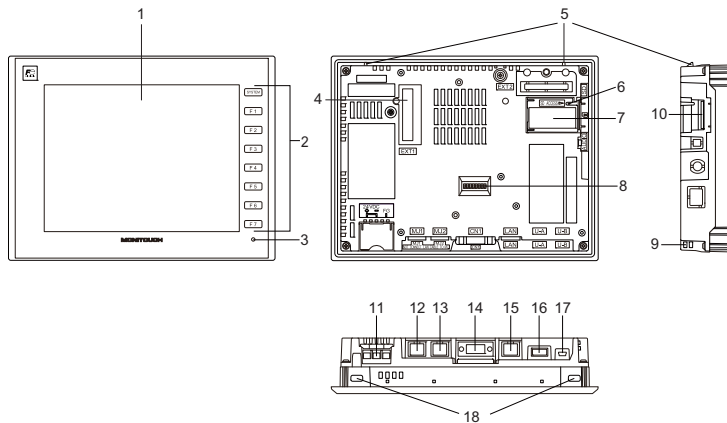

1. Display
This is the display area.
2. Function switches
There are 8 function switches comprising the [SYSTEM] switch and [F1] to [F7] switches. The [SYSTEM] switch is used to display or hide the system menu (for switching between the RUN and Local modes, adjusting brightness, etc.). Switches [F1] to [F7] can be used as user switches in RUN mode.
3. POWER lamp
This lamp illuminates green when the V9 series is powered ON and operating normally. The lamp flashes when there is a failure (backlight failure, circuit board failure, power supply failure).
4. Communication interface unit connector (EXT1)
This connector is used to connect any "CUR-xx" communication interface unit (for SX-BUS, OPCN-1, T-Link, CC-Link, Ethernet, PROFIBUS-DP, DeviceNet, and FL-net).
5. Fall prevention tabs
These tabs prevent the V9 series unit from falling off the mounting panel until the mounting fixtures are tightened.

6. SD card access LED
This LED flashes when the unit is reading from or writing to an SD card.
7. Battery holder
This part contains the backup battery for the SRAM and clock.
When the battery voltage drops, replace the battery with a new one.
8. DIP switches
This 8-bit DIP switch is used for setting the terminating resistance of the CN1 signal line and the MJ1/MJ2 RS-485 signal line.
9. USB cable clamp hole
This clamp hole is used to attach a USB cable tie.
10. SD card slot (SD)
This slot is where an SD card can be inserted.
11. Power supply terminal block
This terminal block supplies power to the V9 series unit (100 to 240 VAC, 24 VDC).
12. Modular jack 1 (MJ1)
This connector is used for screen program transfer and connection with PLCs or other peripheral devices.
13. Modular jack 2 (MJ2)
This connector is used for connection with PLCs or other peripheral devices.
14. PLC communication connector (CN1)
This connector is used for connection to a controller (PLC, temperature controller, inverter, etc.).
15. 100BASE-TX/10BASE-T connector (LAN)
This connector is used for Ethernet connection.
16. USB-A (U-A)
This port is used to connect a printer, USB flash drive, keyboard, or mouse.
17. USB mini-B (U-B)
This port is used for transferring screen programs or connecting a PictBridge-compatible printer.
18. Mounting holes
The mounting holes are used for inserting fixtures when securing the V9 series unit to a mounting panel.

V9060iTD

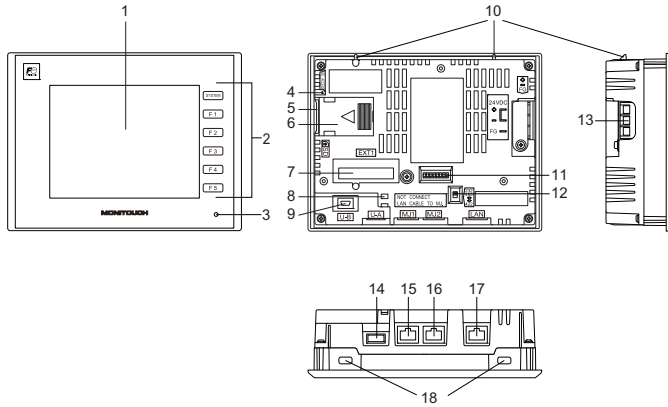

V9060iTD+DUR-00

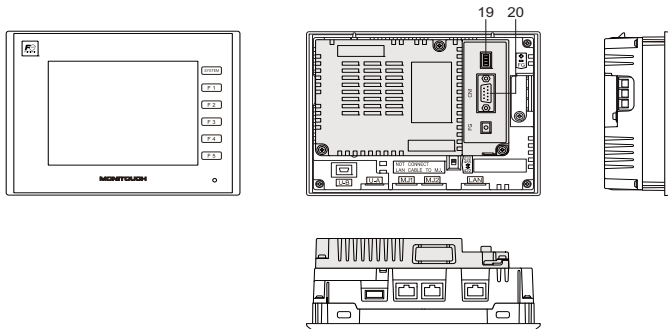

1. Display
This is the display area.
2. Function switches
There are 6 function switches comprising the [SYSTEM] switch and [F1] to [F5] switches. The [SYSTEM] switch is used to display or hide the system menu (for switching between the RUN and Local modes, adjusting brightness, etc.). Switches [F1] to [F5] can be used as user switches in RUN mode.
3. POWER lamp
This lamp illuminates green when the V9 series is powered ON and operating normally. The lamp flashes when there is a failure (circuit board failure, power supply failure).
4. SD card access LED
This LED flashes when the unit is reading from or writing to an SD card.
5. SD card slot (SD)
This slot is where an SD card can be inserted.
6. Battery holder
This part contains the backup battery for the SRAM and clock. When the battery voltage drops, replace the battery with a new one.
7. Communication interface unit connector (EXT1)
This connector is used to connect the optional "DUR-00" unit or any "CUR-xx" communication interface unit (for SX-BUS, OPCN-1, T-Link, CC-Link, Ethernet, PROFIBUS-DP, DeviceNet, and FL-net).
* The "DUR-00" and "CUR-xx" cannot be used at the same time.

8. USB cable clamp hole
This clamp hole is used to attach a USB cable tie.
9. USB mini-B (U-B)
This port is used for transferring screen programs or connecting a PictBridge-compatible printer.
10. Fall prevention tabs
These tabs prevent the V9 series unit from falling off the mounting panel until the mounting fixtures are tightened.
11. DIP switches
This 8-bit DIP switch is used for setting the terminating resistance of the MJ1/MJ2 RS-485 signal line.
12. Sliding switch
This switch is for selecting the RS-232C/RS-485 signal (2-wire connection) or the RS-422 signal (4-wire connection) for MJ2. The upper side is for the RS-232C/RS-485 signal (2-wire connection) and the lower side is for the RS-422 signal (4-wire connection).
13. Power supply terminal block
This terminal block is for supplying power (24 VDC) to the V9 series unit.
14. USB-A (U-A)
This port is used to connect a printer, USB flash drive, keyboard, or mouse.
15. Modular jack 1 (MJ1)
This connector is used for screen program transfer and connection with PLCs or other peripheral devices.
16. Modular jack 2 (MJ2)
This connector is used for connection with PLCs or other peripheral devices.
17. 100BASE-TX/10BASE-T connector (LAN)
This connector is used for Ethernet communication.
18. Mounting holes
The mounting holes are used for inserting fixtures when securing the V9 series unit to a mounting panel.
19. DIP switches (optional "DUR-00" unit)
These switches are used for setting the terminating resistance of the CN1 signal line.
20. PLC communication connector (CN1) (optional "DUR-00" unit)
This connector is used for connection to a controller (PLC, temperature controller, inverter, etc.).

2. Specifications of Components

Serial Connector (CN1)

This connector is used to connect a controller or barcode reader via RS-232C, or connect a controller via RS-422/485.

- V9100

Bottom view

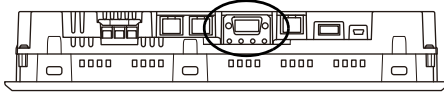

- V9080

Bottom view

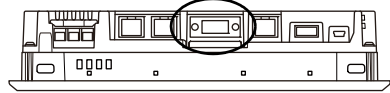

For the V9071iW/V9060iTD, attach the optional "DUR-00" unit to add this serial connector.

- V9071iW

Rear view

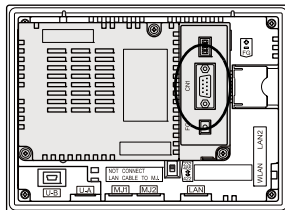

The serial connector pins correspond to the signals as shown below.

CN1 (D-sub 9-pin, female)				
Pin No.	RS-232C ^{*1}		RS-422 / RS-485 ^{*1}	
	Signal	Description	Signal	Description
1	NC	Not used	+ RD	Receive data (+)
2	RD	Receive data	- RD	Receive data (-)
3	SD	Send data	- SD	Send data (-)
4	NC	Not used	+ SD	Send data (+)
5	SG	Signal ground	SG	Signal ground
6	NC	Not used	+ RTS	Request to send (+)
7	RTS	Request to send	- RTS	Request to send (-)
8	CTS	Clear to send	NC	Not used
9	NC	Not used	+ 5 V	Use prohibited ^{*2}

^{*1} The signal level can be changed between RS-232C and RS-422/485 in the configuration software. When RS-232C is selected, set DIP switches 5 and 7 to the OFF position. (For details on DIP switches, refer to "DIP Switches (DIPSW)" (page 3-30).)

^{*2} When RS-422/485 is selected, +5 V is output from pin No. 9. This +5 V is used as the power supply for the external terminating resistance when performing RS-422/485 communication. It cannot be used as an external power supply.

Recommended Connector

The following connector is recommended for custom-made cables.

Recommended Connector	17JE-23090-02(D8C)-CG manufactured by DDK	D-sub 9-pin / male / inch screw thread (#4-40UNC) type / with hood / lead and cadmium free
-----------------------	--	--

Applications

Application	V-SFT-6 Setting	Refer to
PLC/temperature controller connection	Required	V9 Series Connection Manual
Barcode reader connection	Required	
Multi-link/Multi-link2 communication	Required	

Modular Jack (MJ1/MJ2)

The modular jacks are used for connection to a screen program transfer cable (MJ1 only), temperature controller, barcode reader, and other devices.

- V9100

Bottom view

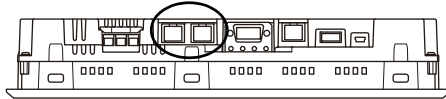

- V907iW

Bottom view

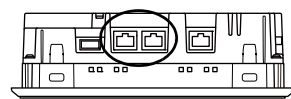

The pins of MJ1 and MJ2 correspond to the signals as shown below.

- V9150, V9120, V9100, V910xiW, V9080 series

MJ1/2	Pin No.	Signal	Description
	1	+SD/RD	RS-485 + data
	2	-SD/RD	RS-485 - data
	3	+5 V	Externally supplied +5 V *1
	4	+5 V	
	5	SG	Signal ground
	6	SG	
	7	RD	RS-232C receive data
	8	SD	RS-232C send data

*1 Allowable current for the +5 V external power supply at MJ1/MJ2 of the V9 series unit
For MJ1, MJ2, and USB-A, the maximum allowable current is 150 mA in total (only when the mounting angle is 60° to 120°).

- V9071iW, V9060iTD series

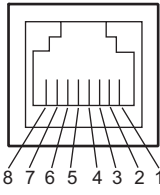
MJ1/2					
					
Pin No.	MJ1		Sliding Switch *1	MJ2	
	Signal	Description		Signal	Description
1	+SD/RD	RS-485 + data	Up	+SD/RD	RS-485 + data
			Down	+SD	RS-422 + send data
2	-SD/RD	RS-485 - data	Up	-SD/RD	RS-485 - data
			Down	-SD	RS-422 - send data
3	+5V	Externally supplied +5 V *2	-	+5V	Externally supplied +5 V *2
4	+5V				
5	SG			SG	
6	SG			SG	
7	RD	RS-232C receive data	Up	RD	RS-232C receive data
			Down	+RD	RS-422 + receive data
8	SD	RS-232C send data	Up	SD	RS-232C send data
			Down	-RD	RS-422 - receive data

*1 The MJ2 sliding switch is on the rear side of the V9071iW, V9060iTD.

Example: V9071iW

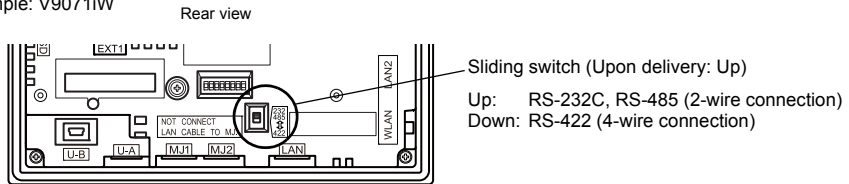

*2 Allowable current for the +5 V external power supply at MJ1/MJ2 of the V9 series unit
 For MJ1, MJ2, and USB-A, the maximum allowable current is 150 mA in total (only when the mounting angle is 60° to 120°).

Applications

Application	V-SFT-6 Setting	Refer to
PLC/temperature controller connection	Required	V9 Series Connection Manual
Barcode reader connection	Required	
Multi-link/Multi-link2 communication	Required	
Ladder transfer function *1	Required	V9 Series Reference Manual 2
Screen program transfer	Not required	V9 Series Operation Manual
Printer connection	Required	V9 Series Reference Manual 1

*1 The ladder transfer function cannot be used simultaneously with 1:n communication (multi-drop) or multi-link communication.

USB-A (Master Port)

This connector is used to connect a printer, USB flash drive, barcode reader, keyboard, mouse, or USB hub. The USB-A port of the V9 unit complies with USB version 2.0.

- V9100

- V9071iW

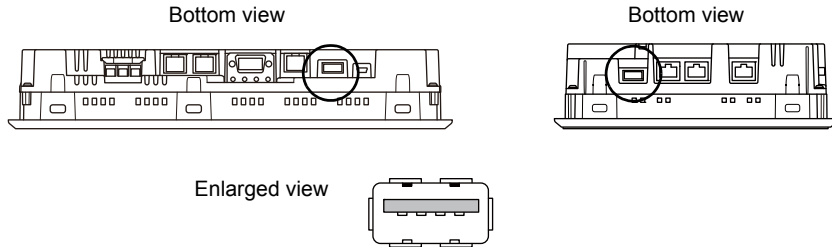

Applications

Application	V-SFT-6 Setting	Refer to
Printer connection	Required	V9 Series Reference Manual 1
USB flash drive connection	Required	See page 3-15.
Barcode reader connection	Required	V9 Series Connection Manual 3
Keyboard/numeric keypad connection	Required	See page 3-16.
Mouse connection	Not required	See page 3-17.
USB hub connection	Not required	See page 3-18.

USB Flash Drives

A USB flash drive can be connected to the V9 series unit to perform operations including screen program transfers or saving of log data.

Connection Example

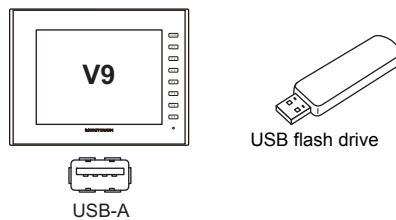

USB Flash Drive Specifications

The type of USB flash drives that can be used with the V9 series are shown below.

Storage	Capacity	File System
USB flash drive	32 GB max.	FAT, FAT32

V-SFT-6 Setting

Required settings vary according to the application.
For more information, refer to V9 Series Reference Manual 2.



Notes on Handling a USB Flash Drive

1. When removing the USB flash drive, select [Storage Removal] in the system menu, or press the [Storage Removal] switch.
2. Do not turn off power to the unit when the USB flash drive is being accessed.
3. Make a backup copy of the USB flash drive at regular intervals.
4. If a disk error occurs and data read/write operations are disabled, execute ScanDisk on Windows and try to restore the disk.
If the disk cannot be restored, format the device. Note that formatting will completely erase all stored data. (For information on executing ScanDisk on Windows, refer to the relevant Windows manual.)
5. USB flash drives have a limited number of write cycles. Consequently, frequent writing at short intervals may shorten the service life of USB flash drives. When using a USB flash drive to save logging/alarm data, take the logging time/monitoring intervals into consideration. Also, avoid repeated writing using the CYCLE macro command.

Keyboard and Numeric Keypad

Numeric values and characters can be entered by connecting a keyboard or numeric keypad to the V9 series unit.

Connection Example

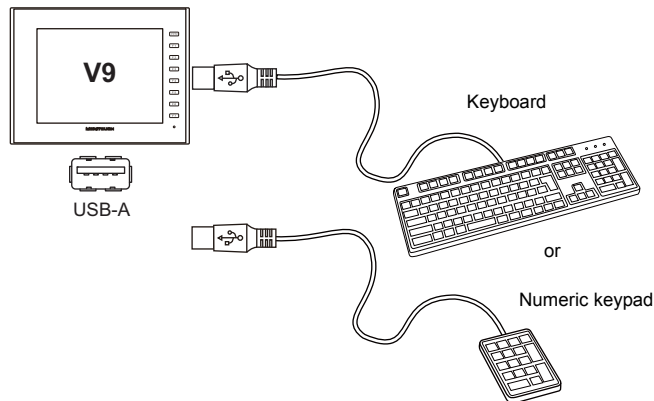

Compatible Keyboards

Type	Description
Japanese keyboard	106 keyboard, 109 keyboard, etc.
US standard keyboard	101 keyboard, 104 keyboard, etc.
Numeric keypad	

V-SFT-6 Setting

An [Entry] icon must be registered on the screen where the keyboard is to be used.

In addition, setting of the numerical data or character display parts of [Entry Target] selected under [Function] is required.

For details, refer to the V9 Series Reference Manual 1.

V9 Series Unit Setting

In the Local mode, select the type of keyboard to be connected.
 For details, refer to the separate V9 Series Troubleshooting/Maintenance Manual.

Mouse

A mouse can be used to operate screens displayed on the V9 series unit by connecting a mouse to the unit.

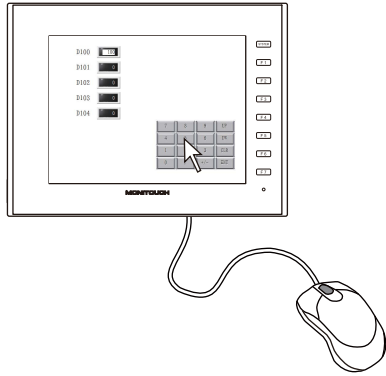

The mouse pointer displayed on the unit is shown below.



Connection Example

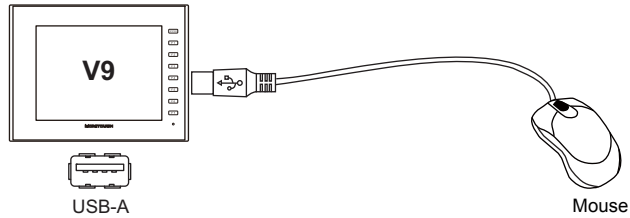

Mouse Operation

The mouse operations available on the unit are shown below.

Mouse Operation	Action
Movement	Moving the mouse pointer
Left-click	Pressing a switch

USB Hub

Devices like printers can be used at the same time by connecting a USB hub to the V9 series unit.

Connection Example

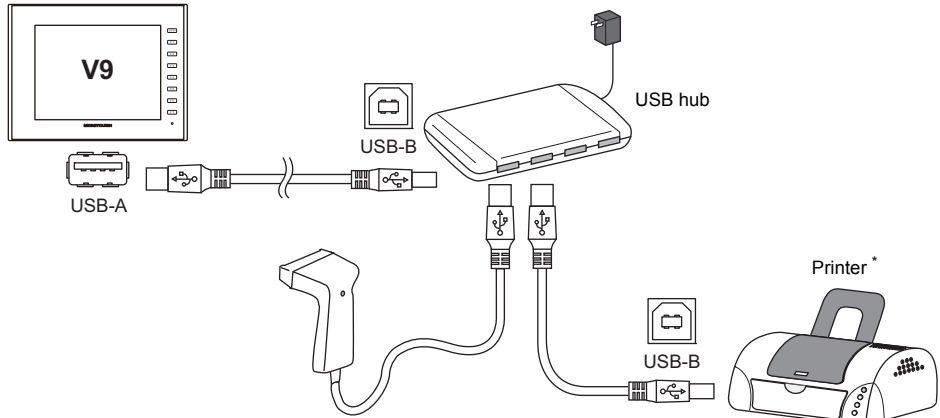

* A parallel printer can also be connected. (In this case, a parallel printer that is compatible with the V9 series and a commercially available parallel-to-USB cable must be used (recommended cable: UC-PGT manufactured by ELECOM.) For more information on compatible printer models, visit our website (<http://www.monitouch.com/>).

Combinations of Connected Devices

Combination of devices usable at the same time: ○

Combination of devices not usable at the same time: ×

	Printer	USB Flash Drive	USB Barcode Reader	Keyboard/ Numeric Keypad	USB Mouse
Printer	-	○	○	○	○
USB Flash Drive	○	-	○	○	○
USB Barcode Reader	○	○	-	× *	○
Keyboard/ Numeric Keypad	○	○	× *	○	○
USB Mouse	○	○	○	○	○

* If these devices are connected at the same time, only the USB barcode reader will be recognized.

Notes

- A maximum of two USB hubs can be connected (cascaded) to the V9 series unit. Note that performance will decrease when two USB hubs are connected.
- Do not turn off the power adaptor or disconnect the connector between the power adaptor and the USB hub when the USB hub is connected to the V9 series unit and powered by the adaptor. Doing so may prevent sufficient power supply to the V9 series unit resulting in faulty operation such as repeated restarting.
- When connecting two USB hubs to the V9 series unit, supply power to each USB hub using the adaptor provided with each hub. Even when connecting only one USB hub, use the provided power supply adaptor (if provided).

USB mini-B (Slave Port)

This connector is used for screen program transfer or connection with a PictBridge-compatible printer. The USB mini-B port of the V9 unit complies with USB version 2.0.

- V9100

Bottom view

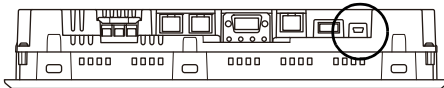

- V9071iW

Rear view

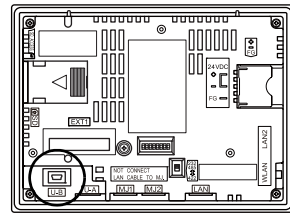

Enlarged view



Applications

Application	V-SFT-6 Setting	Refer to
Ladder transfer function *1	Required	V9 Series Reference Manual 2
PictBridge-compatible printer connection	Required	V9 Series Reference Manual 1
Screen program transfer	Required	V9 Series Setup Manual

*1 The ladder transfer function cannot be used simultaneously with 1:n communication (multi-drop) or multi-link communication.

LAN Connector (LAN)

This connector is used for Ethernet communication with controllers and supports 100BASE-TX and 10BASE-T.

- V9100

- V907iW

Bottom view

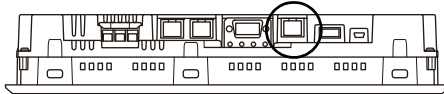

Bottom view

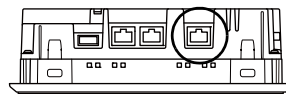

CAUTION

The MJ1 (or MJ2) and LAN connectors are both 8-pin modular jacks. Check the connector names on the unit and insert cables into the correct connectors. Do not connect any peripheral device that will carry excess voltage to the LAN connector.

The LAN connector pins correspond to the signals as shown below.

Specification: IEEE802.3 (u)-compliant, UDP/IP and TCP/IP support, Auto-MDIX and Auto-Negotiation function support

LAN	Pin No.	Signal	Description
	1	TX+	Ethernet send signal (+)
	2	TX-	Ethernet send signal (-)
	3	RX+	Ethernet receive signal (+)
	4	NC	Not used
	5	NC	Not used
	6	RX-	Ethernet receive signal (-)
	7	NC	Not used
	8	NC	Not used

Applications

Application	V-SFT-6 Setting	Refer to
PLC/temperature controller connection	Required	V9 Series Connection Manual
Multi-link2 (Ethernet)/ 1:n Multi-link2 (Ethernet) communication	Required	
Ladder transfer function *1	Required	V9 Series Reference Manual 2
Screen program transfer	Required	V9 Series Setup Manual
Ethernet communication function	Required	V9 Series Reference Manual 2

*1 The ladder transfer function cannot be used simultaneously with 1:n communication (multi-drop) or multi-link communication.

Wiring



CAUTION

When using the LAN port, keep the LAN cable away from the power supply cable as much as possible.

Use a commercially available cable. Using a custom-made cable may prevent normal connection to the network.

Recommended cable: 100 Ω UTP (unshielded twist-pair) cable, category 5, max. 100 m long

* Both straight and cross cables are usable, irrespective of the presence or absence of a hub.

Additional LAN Connector (LAN2) (Only for Additional Wired LAN I/F Models)

This connector is used for Ethernet communication with controllers and supports 100BASE-TX and 10BASE-T.

- V901xiW
Side view

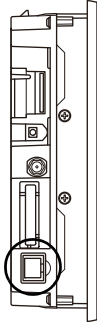

- V9071iW
Side view

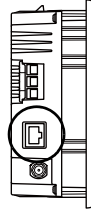

CAUTION

The MJ1 (or MJ2) and LAN connectors are both 8-pin modular jacks. Check the connector names on the unit and insert cables into the correct connectors. Do not connect any peripheral device that will carry excess voltage to the LAN connector.

The specifications and applications are the same as “LAN Connector (LAN)” (page 3-20).

Connector for Wireless LAN Dipole Antenna (WLAN) (Only for Wireless LAN I/F Models)

This connector is for connecting the external dipole antenna “V9-ANT” (optional) for wireless LAN.

- V901xiW

Side view

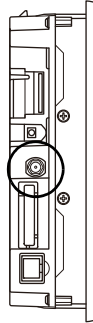

- V9071iW

Side view

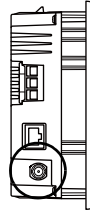

Wireless LAN specifications are shown below.

Item	Specification
Wireless LAN Standards	IEEE802.11b, IEEE802.11g, IEEE802.11n
Communication Frequency *1	2.4 GHz band (2.412 GHz to 2.462 GHz)
Channels *2	1 to 11 ch (for all countries) (Channel spacing: 5 MHz)
Transmission Mode	<ul style="list-style-type: none"> • 11b: Direct-sequence spread spectrum (DS-SS) • 11g: Orthogonal frequency-division multiplexing (OFDM) • 11n: Orthogonal frequency-division multiplexing (OFDM)
Transmission Rate	<ul style="list-style-type: none"> • 11b: 1, 2, 5.5, 11 Mbps • 11g: 6, 9, 12, 18, 24, 36, 48, 54 Mbps • 11n, HT20 (GI: 800 ns) 1 stream: 6.5, 13, 19.5, 26, 39, 52, 58.5, 65 Mbps • 11n, HT20 (GI: 400 ns) 1 stream: 7.2, 14.4, 21.7, 29.9, 43.3, 57.8, 65, 72.2 Mbps
Antenna Power (Output Power)	Max. 10 mW/MHz
Complying Antennas	<ul style="list-style-type: none"> • Built-in antenna of the V9 series unit • V9-ANT (optional): External dipole antenna for wireless LAN
Polarization	Vertical polarization
Horizontal radiation pattern	<ul style="list-style-type: none"> • Built-in antenna of V9 series unit: Directional • V9-ANT (optional): Omnidirectional
Operation Mode	<ul style="list-style-type: none"> • Infrastructure mode (access point, station) • Ad-hoc mode * Selected in Local mode.
Authentication	OPEN SYSTEM, WPA-PSK, WPA2-PSK
Encryption Method	NONE, WEP, TKIP, AES
Clients	Max. 6 (when the V9 series unit is in access point mode)
Conformance Standards *3 *4	<ul style="list-style-type: none"> • TELEC (Japanese Radio Law: Technical Regulations Conformity Certification, Article 2, clause 1-19) • FCC Part15 SubPart C • IC RSS-210, RSS-Gen • R&TTE: EN300328, EN301489-1, EN301489-17, EN62311, EN60950-1 • KC

*1 According to wireless LAN standards, the 2.4 GHz communication frequency band can be used indoors and outdoors. However, if UL standard certification is required, installation conditions must conform to those designated by the UL standard.

*2 Channels 1 to 11 which can be used in all countries are enabled. Channels 12 to 14 cannot be used.

*3 The V9 series unit will not conform to the above laws if using any antenna other than the built-in antenna or the optional V9-ANT for wireless LAN connection.

*4 V9150iXRD, V9120iSRD, V9100iSRD and V9080iSRD conform with only the Japanese Radio Law.

Notes on Wireless LAN

- An antenna is built into the V9 series unit for use as a wireless communication antenna. Consider your usage environment, and if necessary, use Hakko Electronics' "V9-ANT" external dipole antenna (optional).
(The built-in antenna of the V9 series unit can be used for wireless LAN communication within 10 meters from the front side of the V9 series unit. For wireless LAN communication around the V9 series unit (360°) or more than 10 meters away from the V9 series unit, use of the "V9-ANT" is recommended.)
- Radio waves used by wireless LAN pass through wood and glass, and therefore communication is possible even if floors and walls are made of wooden or glass material. However, radio waves cannot penetrate reinforcing rods, metal, or concrete, so if these materials are used communication is not possible.
Signal intensity can be checked using the Received Signal Strength Indication (RSSI) as a guideline. Placing the V9 series unit (access point) so that the RSSI value is higher will attain a more stable communication status.
A low RSSI value, which does not improve by moving the position of the V9 series unit (access point) or antenna, indicates that the radio wave intensity is weakened due to a long communication distance or physical obstructions.
- The radio waves used for wireless LAN communication are divided into frequency bands called channels (ch). The V9 series spaces the 2.4 GHz band into 11 channels (1 to 11 ch) at 5 MHz intervals. However, if the same channel is used or neighboring channels interfere with each other, communication speed may be reduced.
We recommend selecting channels for access points so that the frequencies do not overlap, such as 1 ch, 5 ch and 9 ch (when using MONITOUCH as an access point).

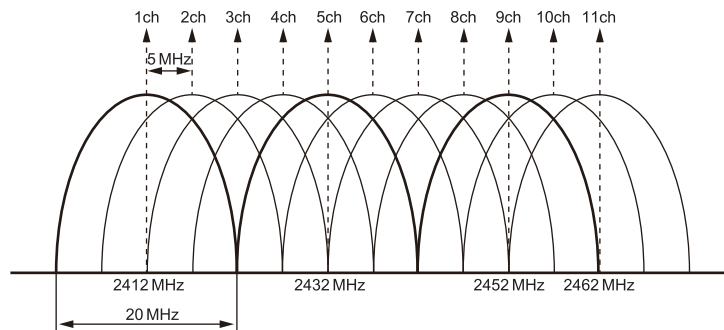

Notes on Radio Waves

- The wireless LAN function of the V9 series corresponds to "radio equipment for radio stations (antenna power: 10 mW/MHz or less) of low-power data communication systems" defined by radio law, and therefore does not require a radio license.
- Depending on the peripheral environment or installation conditions, data transmission via wireless LAN may be unstable compared to wired connections and result in packet loss.
Be sure to check the connection before actual use.
- Do not use the wireless LAN function in the following situations.
 - 1) Near a person who uses a cardiac pacemaker: The function may cause electromagnetic interference in cardiac pacemakers, leading to malfunctions.
 - 2) Near medical devices: The function may cause electromagnetic interference in medical devices, leading to malfunctions.
 - 3) Near microwaves: Microwaves may cause electromagnetic interference in wireless communications of the V9 series unit.

- Radio equipment which use the 2.4 GHz frequency band
Models that support wireless LAN use the 2.4 GHz frequency band. This frequency band is used for industrial, scientific, and medical equipment; on-site radio stations (requiring a radio license) and certain low-power radio stations (no radio license required) for identifying moving objects in production lines; and amateur radio stations (requiring a radio license).
 - 1) Before using the wireless LAN function, check that there are no on-site radio stations and certain low-power radio stations for identifying moving objects or amateur radio stations in use nearby.
 - 2) If ever the V9 series unit causes wave interference to an on-site radio station for identifying moving objects, immediately stop wireless LAN communication and ensure that waves are no longer emitted. Then take necessary actions to resolve the interference (e.g. changing frequencies, relocating, installing partitions).
 - 3) If the V9 series unit causes wave interference to a certain low-power radio station for identifying moving objects, or if any other problem occurs, contact your distributor.
- The product will not conform to radio laws if using any antenna other than the built-in antenna of the V9 series unit or the external dipole antenna "V9-ANT" (optional).
- The wireless LAN function conforms to the radio standards in the following countries *.
Never use the V9 series unit outside of these countries.
Australia, Belgium, Canada, Czech, Denmark, Finland, France, Germany, Great Britain, Greek, Hungary, Ireland, Italia, Japan, Netherlands, Norway, Poland, Portugal, Slovakia, Slovenia, South Korea, Spain, Sweden, Switzerland, United States of America
 - * V9150iXRD, V9120iSRD, V9100iSRD, and V9080iSRD are available for use in Japan only.

Notes on Security

A wireless LAN transmits data between a computer and a wireless LAN access point without using a LAN cable. Therefore, as long as radio waves are transmitted, LAN connection can be established whenever desired.

On the other hand, within a certain range, radio waves will pass through all obstructions (such as walls) and reaches the entire area. If security settings are not made, the following problems may occur.

Transmission contents can be eavesdropped on

- A malicious third party can eavesdrop on communication contents and steal identity such as your ID, password, and credit card numbers, or eavesdrop on email contents.

Unauthorized intrusions

- A malicious third party may access personal or corporate networks without authorization and steal identity or confidential information (information leakage).
- An attacker can impersonate you and send out false information (impersonation).
- Communication contents can be intercepted and then manipulated before sending (manipulation).
- Data and systems can be destroyed using a computer virus (destruction).

Principally, models that support wireless LAN have security functions. If such functions are properly configured before use, any risks of sustaining the above attacks can be reduced.

We recommend configuring security functions before use at your own judgment and responsibility, and fully understand the problems that may occur if the V9 series unit is used without configuring security functions.

Applications

Application	V-SFT-6 Setting	Refer to
Screen program transfer	Not required	V9 Series Operation Manual
Ethernet communication function (excluding PLC 8WAY communication)	Depends on function	V9 Series Reference Manual 2

- * Configurations in Local mode of the V9 series unit are required to use wireless LAN. For details, refer to the V9 Series Troubleshooting/Maintenance Manual.

Communication Interface Unit Connector (EXT1)

This is a connector for attaching the communication interface unit “CUR-xx”.

The connector on the V907xiW, V9060iTD can also be used for attaching the optional “DUR-00” unit.

- V9100

Rear view

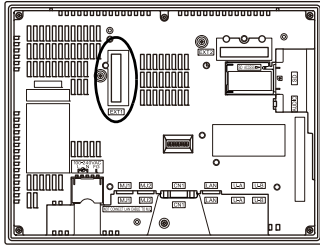

- V9071iW

Rear view

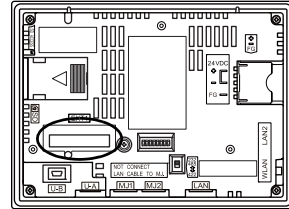

The types of communication interface units are shown below.

Type	Communication Specification
CUR-00	OPCN-1
CUR-01	T-Link
CUR-02	CC-Link
CUR-03	Ethernet
CUR-04	PROFIBUS-DP
CUR-06	SX BUS
CUR-07	DeviceNet
CUR-08	FL-net

* For details on specifications and how to attach a communication interface unit, refer to the respective V9 Series Communication Unit Specifications.

Optional Unit Connector (EXT2) (V910xiW/Standard Models Only)

This is a connector for attaching the optional “GUR-xx” unit.

- V9100iS

Rear view

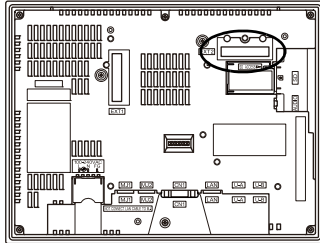

- V9080iS

Rear view

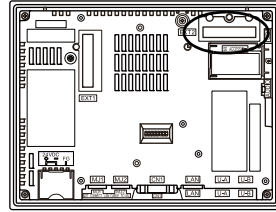

The types of optional units are shown below.

Type	Communication Specification
GUR-01	RGB input 1 CH
GUR-02	RGB output 1 CH
GUR-04	Video input 1 CH

* For details on specifications and how to attach an optional unit, refer to the respective instruction manual.

SD Card Interface (SD)

This is the interface used for inserting an SD card.

An SD card can be used to transfer screen programs and save log data and image data.

- V9100

Side view

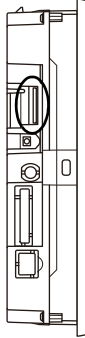

- V907iW

Side view

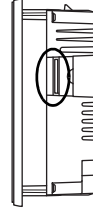

SD Card Specifications

SD cards that are compatible with the V9 series are shown below.

* This manual collectively refers to the following cards as "SD cards".

Card Type	Capacity	File System
SD card	2 GB max.	FAT, FAT32
SDHC card	4 GB to 32 GB	FAT32

SD Card Access LED

The state of the SD card access LED is configured as shown below.

LED	Description
Off	The SD card is not being accessed. The SD card can be removed.
Flashing red	The SD card is being accessed. The LED turns off when access is complete.

Applications

- For details on functions that use an SD card, refer to the separate V9 Series Reference Manual 2.
- For details on reading and writing between an SD card and the V9 series unit, refer to the separate V9 Series Troubleshooting/Maintenance Manual.



Notes on SD Card Handling

1. The SD card access LED flashes red when the SD card is being accessed. Do not remove the SD card while the LED is flashing. Doing so may destroy data on the SD card.
2. When removing the SD card, check that the SD card access LED has turned off, then select [Storage Removal] in the system menu, or press the [Storage Removal] switch.
3. Do not turn off power to the unit when the SD card is being accessed.
4. Make a backup copy of the SD card at regular intervals.
5. If a disk error occurs and data read/write operations are disabled, execute ScanDisk on Windows and try to restore the disk.
If the disk cannot be restored, format the device. Note that formatting will completely erase all stored data. (For information on executing ScanDisk on Windows, refer to the relevant Windows manual.)
6. SD cards have a limited number of write cycles. Consequently, frequent writing at short intervals may shorten the service life of SD cards. When using an SD card to save logging/alarm data, take the logging time/monitoring intervals into consideration. Also, avoid repeated writing using the CYCLE macro command.

Audio Output Connector (AUDIO) (V910xiW/Standard Models Only)

This terminal is used for audio output.

* **An external speaker with a built-in amplifier is required to play audio.**

- V9100iS

Side view

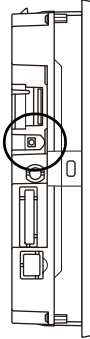

- V9080iS

Side view

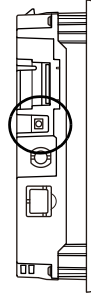

The specifications of playable audio are as shown below.

Item	Specification
Playable Files	WAV (PCM)
Sampling Frequency	<ul style="list-style-type: none"> • 8 kHz • 16 kHz • 32 kHz • 44.1 kHz • 48 kHz • 96 kHz • 192 kHz
Quantization Bit	<ul style="list-style-type: none"> • 8 bits • 16 bits • 24 bits
Audio Source	<ul style="list-style-type: none"> • Monaural • Stereo
Volume Control	8 levels (Macros can vary the volume from -21 dB to 0 dB in 3 dB steps.) Default: -6 dB
External Connection Terminal	φ3.5 mm stereo mini jack
Max. Output Voltage	2.1 Vrms (0 dB)
Connected Amplifier	Input impedance of 1 KΩ or more

Applications

Application	V-SFT-6 Setting	Refer to
Playing audio	Required	V9 Series Reference Manual 2

DIP Switches (DIPSW)

V9150, V9120, V9100, V910xiW, V9080 Series

The V9 series unit is equipped with DIP switches 1 to 8. Turn OFF power to the unit before changing any DIP switches.

Upon delivery, all DIP switches are set to OFF.

- V9100

Rear view

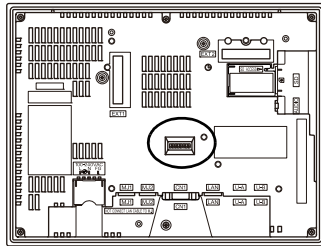

- V9080

Rear view

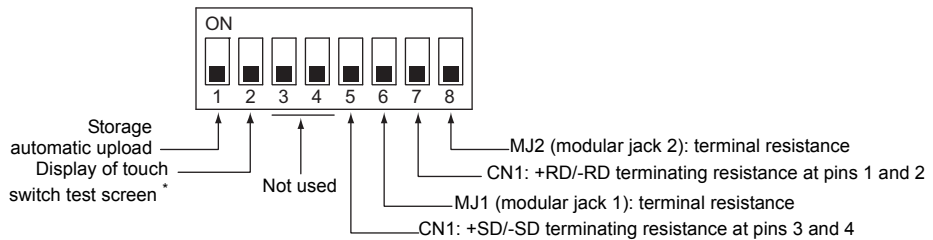
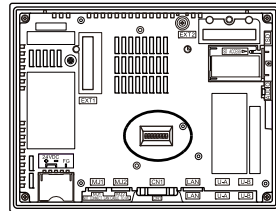

* Only for V910xiW

DIPSW1 (Storage Automatic Upload)

Set DIPSW1 to ON to automatically upload screen programs from a storage device such as an SD card or USB flash drive.

Procedure

1. Preparation of storage
Use the V-SFT-6 editor to load a screen program onto a storage device.
(For the loading procedure, refer to the V9 Series Reference Manual 2.)
2. Connection of storage
Turn OFF power to the V9 series unit and connect the storage device (insert an SD card or connect a USB flash drive to the USB-A port).
3. DIP switch settings
Slide DIPSW1 upward to the ON position.
4. Automatic upload start
Turn ON power to the V9 series unit. The screen program is automatically loaded into the flash memory of the V9 series unit.

* When not using automatic upload, always set DIPSW1 to OFF.

DIPSW2 (Display of Touch Switch Test Screen) For V910xiW Only

Set DIPSW2 to ON to check if touch switches are functioning properly.

* Touch switch adjustment is available for the V9100iw (analog resistive film type)

For more information on touch switch adjustment, refer to the V9 Series Troubleshooting/Maintenance Manual.

Procedure

1. DIP switch settings
Slide DIPSW2 upward to the ON position.
2. Display of initial touch switch adjustment screen
Turn ON power to the V9 series unit. The touch switch test screen is displayed.
Check if touch switches are functioning properly.

* When not using the test, always set DIPSW2 to OFF.

DIPSW3, 4 (Not Used)

Set these DIP switches to OFF.

DIPSW5, 6, 7, 8 (Terminating Resistance Setting)



CAUTION

When connecting a controller to CN1 via RS-232C, set DIPSW5 and 7 to the OFF position.

- When connecting a controller to CN1 via RS-422/485 (2-wire connection), set DIPSW7 to the ON position.
- When connecting a controller to CN1 via RS-422/485 (4-wire connection), set DIPSW5 and 7 to the ON position.
- For the following connections to modular jack 1 or 2, set DIPSW6 or 8 to the ON position.
 - Connection to a controller (PLC, temperature controller, etc.) via RS-485
 - Connection to the V9 series unit at the termination of V-link connection via RS-485

V907xiW, V9060iTD Series

The V9 series unit is equipped with DIP switches 1 to 8. Turn OFF power to the unit before changing any DIP switches.

Upon delivery, all DIP switches are set to OFF.

- V9071iW

Rear view

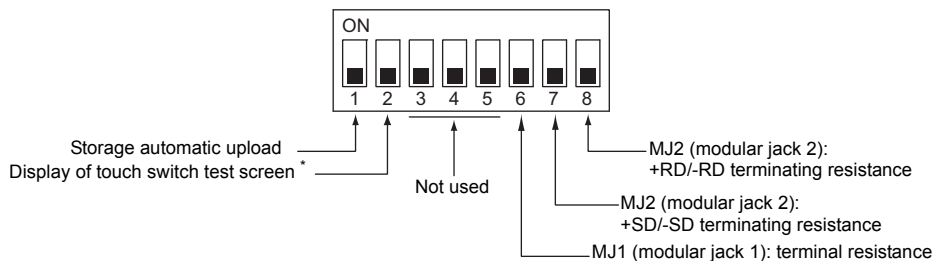
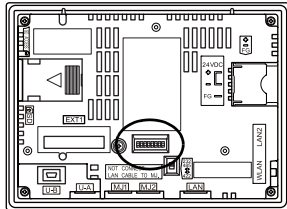

* Only for V907xiW

DIPSW1 (Storage Automatic Upload)

Set DIPSW1 to ON to automatically upload screen programs from a storage device such as an SD card or USB flash drive.

Refer to "DIP Switches (DIPSW)" (page 3-30) for the procedure.

DIPSW2 (Display of Touch Switch Test Screen) Only for V907xiW.

Set DIPSW2 to ON to check if touch switches are functioning properly.

Refer to "DIPSW2 (Display of Touch Switch Test Screen) For V910xiW Only" (page 3-31) for the procedure.

- * Touch switch adjustment is available for the V9070iW (analog resistive film type).
For details on touch switch adjustment, refer to the V9 Series Troubleshooting/Maintenance Manual.

DIPSW 3, 4, 5 (Not Used)

Set these DIP switches to OFF.

DIPSW 6, 7, 8 (Terminating Resistance Setting)

- Connection at MJ1 via RS-232C and RS-485 (2-wire connection) is possible. Turn DIPSW6 to ON for the following situations.
 - Master station for multi-link2 connection
 - Connection to a controller (PLC, temperature controller, etc.) via RS-485
 - At the termination of V-link connection via RS-485
- Connection at MJ2 via RS-232C, RS-422 (4-wire connection), or RS-485 (2-wire connection) is possible.
When connecting via RS-485 (2-wire connection), set DIPSW8 to ON. When connecting via RS-422 (4-wire connection), set DIPSW7 and 8 to ON.

DUR-00

The unit is equipped with DIP switches 1 to 4. Turn OFF power to the unit before changing any DIP switches.

Upon delivery, all DIP switches are set to OFF.

Rear view

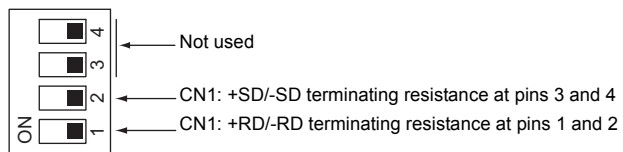
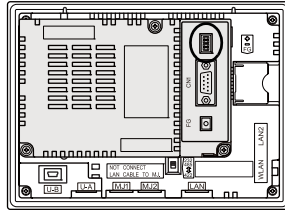
**DIPSW 1, 2 (Terminating Resistance Setting)****CAUTION**

When connecting a controller to CN1 via RS-232C, set DIPSW1 and 2 to the OFF position.

- When connecting a controller to CN1 via RS-422/485 (2-wire connection), set DIPSW1 to the ON position.
- When connecting a controller to CN1 via RS-422/485 (4-wire connection), set DIPSW1 and 2 to the ON position.

MEMO

Please use this page freely.

4 Installation

1. Installation Procedure
2. Power Supply Cable and Grounding Connections
3. Securing USB Cables
4. Inserting and Removing SD Cards
5. Installing the Battery

1. Installation Procedure

Installation Procedure

1. Place the V9 series unit on a flat surface with the display facing down. Insert the provided waterproof gasket into the groove around the unit.



CAUTION

- The unit will not be waterproof if the waterproof gasket is not correctly inserted into the groove.

Example: When mounting the V9100iS unit in the upright orientation

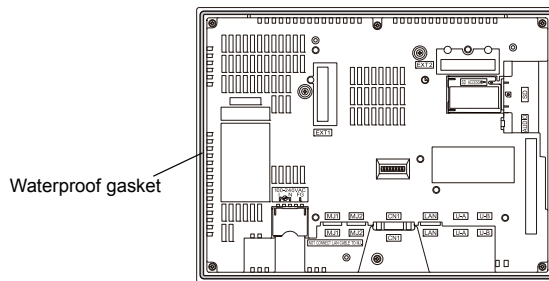

2. Mount the V9 series unit into the mounting panel (maximum thickness of 4.0 mm) while paying attention to the fall prevention tabs.

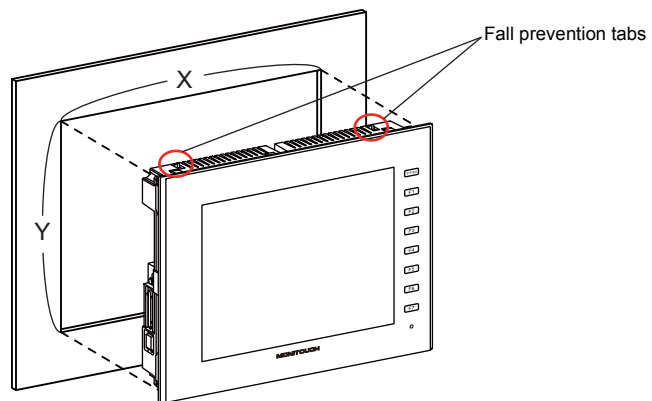

3. Insert the four fixtures provided with the V9 series unit into the mounting holes and tighten them with the tightening screws (tightening torque: 5.31 lbf-in (0.6 N·m)).

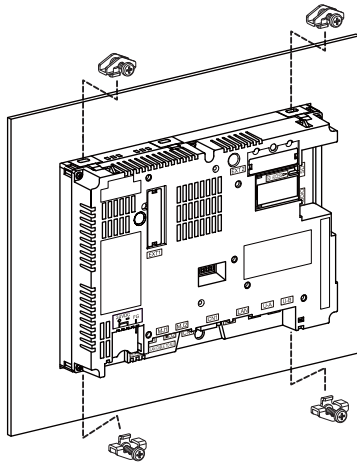

- Fixture dimensions (unit: mm)

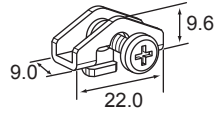

- Dimensions of a tightened fixture that protrudes from the edge of the V9 series unit (unit: mm)

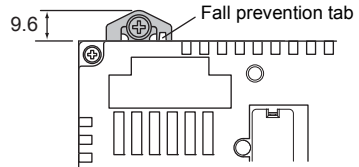

For the V9150 series, use eight fixtures to mount the unit.

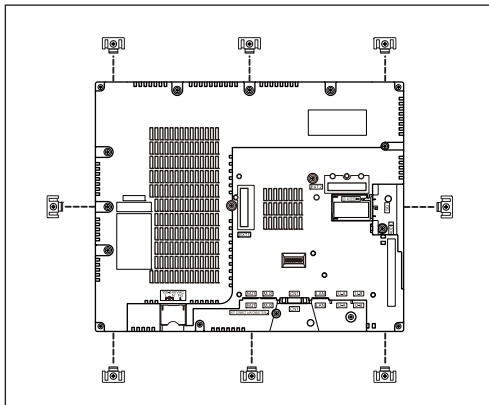

- Fixture dimensions (unit: mm)

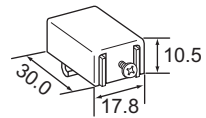

- * If the screws are tightened to a torque higher than stated above or the torque at each location is not equal, the surface sheet may warp due to deformation in the mounting panel and unit.
- * When mounting the V9 series unit rotated 90 ° to the right or left, insert and secure the fixtures in the same mounting holes shown in the figure below.
- * Ground the mounting panel to prevent any buildup of static electricity.

Installation Conditions

Mounting Orientation

The V9 series can be mounted in the following orientations.

Example: V9100iS

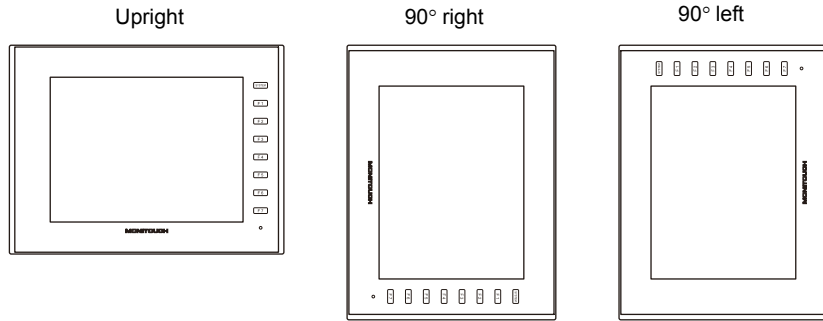

Panel Cut-out Dimensions

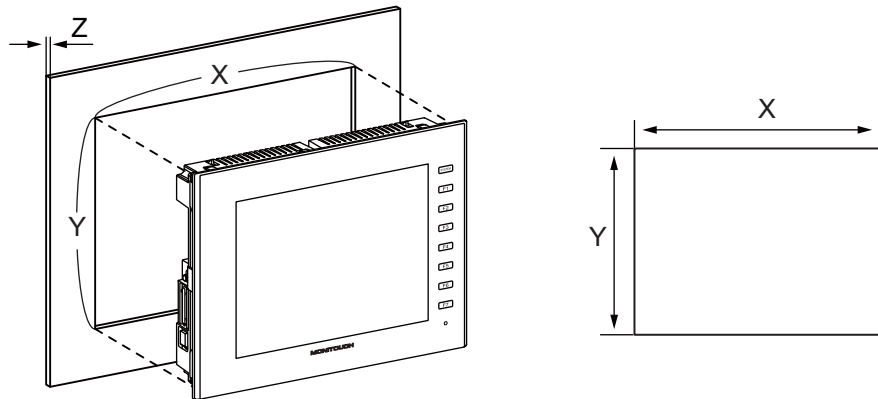

(Unit: mm)

Model	X	Y	Z (panel thickness)
V9150iX	369.4 ^{+0.5} ₋₀	299.4 ^{+0.5} ₋₀	1.5 - 4.0
V9120iS	313.0 ^{+0.5} ₋₀	246.2 ^{+0.5} ₋₀	
V9100iS / V9100iC	289.0 ^{+0.5} ₋₀	216.2 ^{+0.5} ₋₀	
V910xiW	257.0 ^{+0.5} ₋₀	183.0 ^{+0.5} ₋₀	
V9080iSD / V9080iCD	220.5 ^{+0.5} ₋₀	165.5 ^{+0.5} ₋₀	
V907xiW	187.2 ^{+0.5} ₋₀	133.4 ^{+0.5} ₋₀	
V9060iTD	174.0 ^{+0.5} ₋₀	131.0 ^{+0.5} ₋₀	

Mounting Spatial Restrictions

Mount the V9 series unit with approximately 100 mm of space around the periphery of the unit.

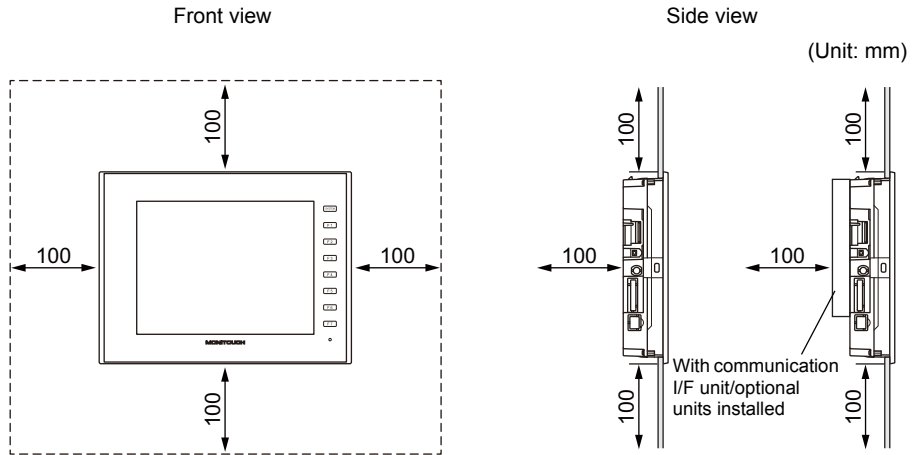

Mounting Angle

The mounting angle differs depending on the mounting orientation. Mount the unit within the angle ranges shown in the table below.

Mounting Orientation	Mounting Angle
<p>Upright</p>	<p>90° 135° 0° 15° Display</p>
<p>90° right 90° left</p> <p>or</p>	<p>90° 120° 0° 60° Display</p>

* When supplying power externally from a modular jack (MJ1/MJ2) or USB-A, mount the V9 series unit at an angle between 60° and 120°.

Ambient Temperature

Use the V9150 series in an ambient temperature range of 0 °C to +40 °C (wet-bulb temperature of 39 °C or less).

Regarding other models, use in a range of 0 °C to +50 °C (wet-bulb temperature of 39 °C or less).

2. Power Supply Cable and Grounding Connections



There is a risk of electrical shock.
Shut the power off before connecting the power supply cable.

Power Supply Cable Connection

Connect the power supply cable to the terminal on the backside of the unit.

- V9150, V9120, V9100

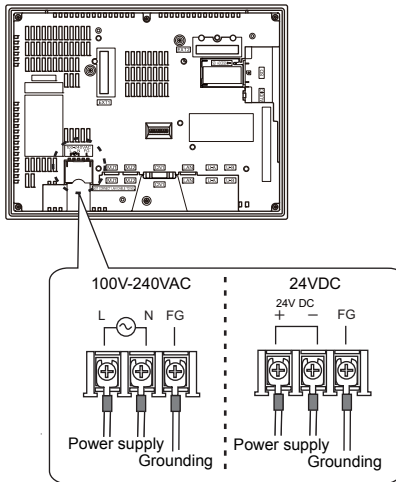

- V910xiW, V9080

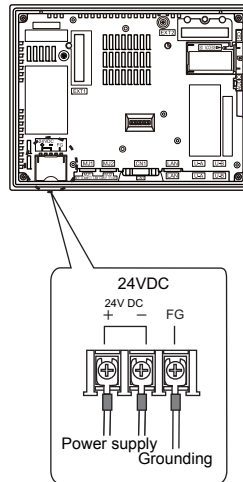

- V907xiW

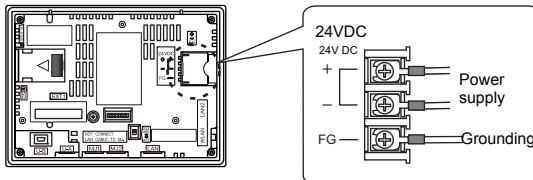

- V9060iTD

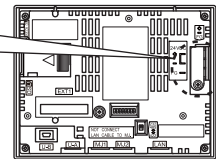

- For information on the specifications of the power supply cable and the tightening torque of the screws on the power supply terminal block, refer to the following table.

Terminal Screw			Power Supply Cable
Screw Size	Tightening Torque	Crimp-style Terminal	
M3.5	7.1 to 8.8 lbf-in (0.8 to 1.0 N·m)		AWG16 to 14

Notes on the Power Supply

- The power supply must be used within allowable range of voltage fluctuation.
- Use a power supply with low noise between cables and between the ground and cables.
- Use the thickest power supply cable possible that is twisted to minimize drops in voltage.
- Keep power supply cables away from high-voltage, large-current carrying cables.
- When using models V9101iW or V9071iW (capacitive type touch panel), use a Class 2 power supply for a 24-VDC input.

Notes on Usage of the 100 to 240 VAC Specification

- The V9 series is an overvoltage category II product.
- While the use of an isolating transformer generally improves noise resistance, if the V9 series unit is a significant distance from the secondary port of the transformer or noise interference occurs easily, an isolating transformer is ineffective.
- If any power voltage fluctuation caused by noise is expected, the use of a voltage stabilizer (effective for noise resistance) is recommended.

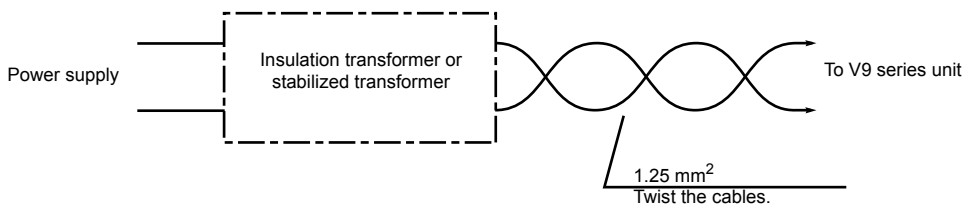

Grounding



Always ground the V9 series.
(The level of grounding resistance should be less than 100 Ω.)

- An independent grounding must be used for the unit.
- Use a grounding cable with a nominal cross section of more than 2 mm².
- Set the grounding point near the unit to shorten the distance of grounding cables.
- The signal ground (SG) and frame ground (FG) are connected inside the V9150 series unit.

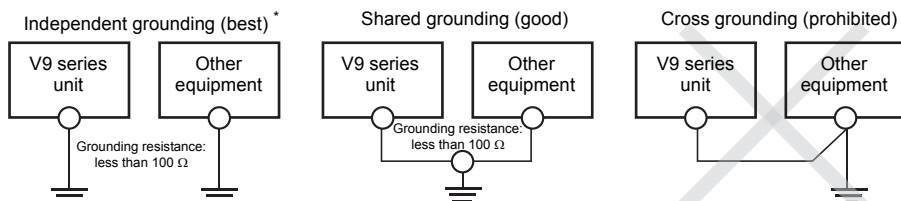

* For models V9101iW and V9071iW (capacitive type touch panel), use independent grounding.

3. Securing USB Cables

USB cables may disconnect from the V9 series unit depending on the mounting conditions. Use the cable tie provided with the unit to prevent disconnection.

Securing USB Cables

1. Preparing a cable tie

Pass a cable tie through the hole as shown in the figure below.

- * For the V910xiW, V907xiW and V9060iTD, pass the cable tie through the lower side upward.
- For the V9150, V9120 and V9100, pass the cable tie through the hole from left to right.

• V910xiW

Rear view

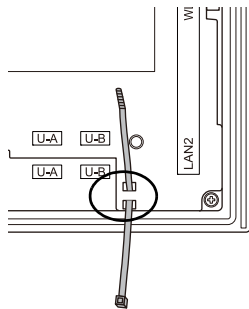

• V907xiW and V9060iTD

Rear view

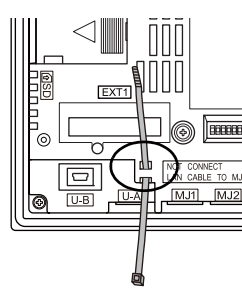

• V9150, V9120 and V9100

Rear view

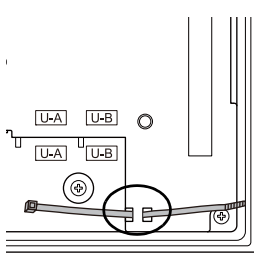

• V9120 and V9100

Rear view

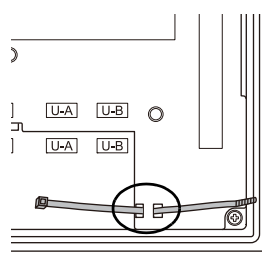

• V9080

Side view

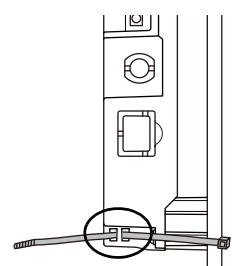

2. Inserting and securing a USB cable

Insert a USB cable and secure it using the cable tie.

Example:

When only USB-A is used	When only USB mini-B port is used	When both USB-A and USB mini-B (two cables) are used

4. Inserting and Removing SD Cards

SD Card Insertion/Removal Procedure

1. Hold the SD card in the same orientation (SD card rear) as shown by the SD card pictured on the unit and then insert the SD card into the slot until it clicks.



Insert the SD card into the V9 series unit in the correct orientation.
Failure to do so may damage the SD card or the slot on the unit.

Example: V910xiW

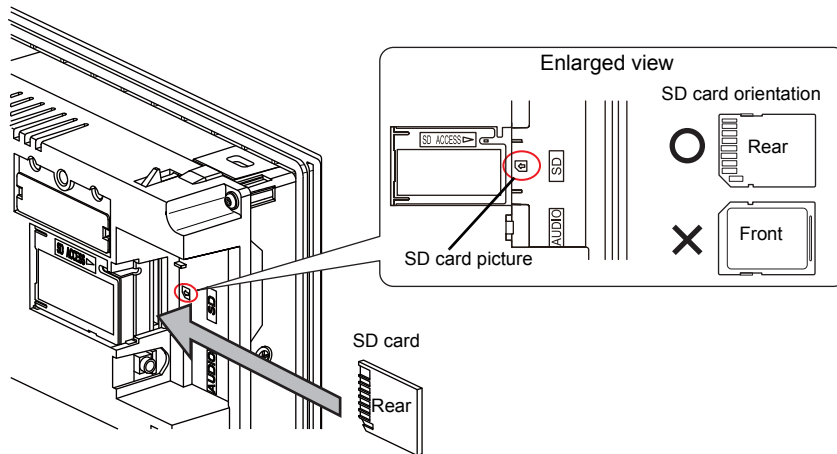

2. Check that the SD card access LED is unlit before removing the SD card. Push the SD card until it clicks and then the SD card will come out. Pinch the SD card with your fingers and remove it from the slot.

* When removing the SD card, select [Storage Removal] in the system menu, or press the [Storage Removal] switch.

5. Installing the Battery

CAUTION A battery is already installed upon delivery.

Role of the Battery

The battery provides backup power to the user memory area in SRAM (non-volatile memory \$L and \$LD, sampling data) as well as the built-in clock.

Battery Replacement Period

The service life of the battery is about 5 years from the date of manufacture. When the battery voltage drops, the message “Battery changeover required” appears at the lower right in the Local mode on the V9 series unit.

* For information on the Local mode, refer to the separate V9 Series Troubleshooting/Maintenance Manual.

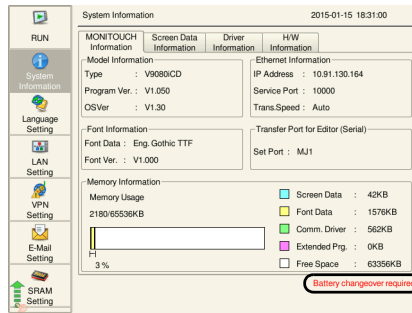

Battery Voltage Drop Detection

The battery status is output to the internal device memory address \$\$s167 of the V9 series unit. When the battery voltage drops, the 4th bit of \$\$s167 turns ON. If the battery voltage drops (4th bit turns ON) within the expiration date (five years), replace the battery immediately.

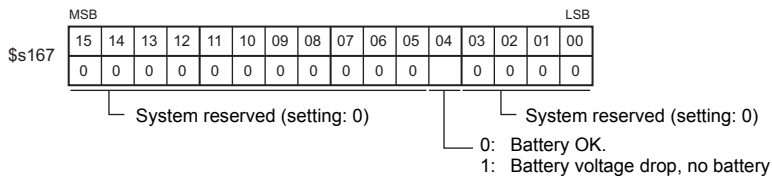

Battery Replacement

Replacement batteries are available from Hakko Electronics.

- V9150, V9120, V9100, V910xiW, V9080 series

Name	Model	Description
Battery for replacement	V9-BT	<ul style="list-style-type: none"> Coin-type lithium primary cell (CR2450S manufactured by Sony Energy Devices) 1 pce. Caution sticker 1 pce.

* When using a commercially available battery, use “CR2450S” manufactured by Sony Energy Devices.

- V907xiW, V9060iTD series

Name	Model	Description
Battery for replacement	V7-BT	<ul style="list-style-type: none"> • Coin-type lithium primary cell 1 pce. • Caution sticker 1 pce.

* Commercially available batteries cannot be used.

Safety Instructions on Handling Batteries

Lithium batteries contain combustible material such as lithium and organic solvents. Mishandling may cause heat, explosion, or ignition resulting in fire or injury. To prevent accidents, pay attention to the following cautions when handling lithium batteries.



CAUTION

- Only experts are authorized to perform battery replacement.
- Be sure to discharge static electricity from your body before performing battery replacement.
- Use the recommended battery for replacement.
- Rough handling of the battery may cause fire or chemical burns.
- Do not disassemble, incinerate, or heat the battery.
- Observe local and governmental regulations when disposing of waste batteries.
- Keep batteries out of reach of children. (If swallowed, immediately consult a doctor.)
- Never recharge the battery.
- If a battery leaks or smells, note that the leaking battery electrolyte is flammable. Keep away from heat or flame.

SRAM Area Backup Procedure

Replace the "V9-BT"/"V7-BT" battery within three minutes after the unit is turned off.

If it is not possible to replace the battery within three minutes, use the V-SFT-6 editor or a storage device to make a backup copy of the data in SRAM.

When Using the V-SFT-6 Editor

- 1) Connecting a cable
Connect the V9 series unit and the computer using the transfer cable ("V-CP", USB cable, or Ethernet cable).
 - 2) Starting the V-SFT-6 editor
Start the V-SFT-6 editor on the computer.
 - 3) Displaying the [Transfer] dialog
Click [Transfer] → [Upload]. The [Transfer] dialog is displayed.
 - 4) Selecting data to be transferred
Select [SRAM Data] for [Transfer Data].
 - 5) Starting SRAM data transfer
Click the [PC <-] button. Data transfer from the SRAM is started.
 - 6) Saving the SRAM data
When the SRAM data has been transferred, the [Save As] dialog is displayed on the computer. Save the data as a backup copy. The file extension is "*.RAM".
- * To transfer the "*.RAM" data, which was saved as a backup copy, back to the V9 series unit, click [Transfer] → [Download] in step 3, and click the [PC ->] button in step 5.

When Using a Storage Device:

For details on the method for making backups using a storage device such as an SD card or USB flash drive, refer to the separate V9 Series Troubleshooting/Maintenance Manual.

Battery Replacement Procedure

V9150, V9120, V9100, V910xiW, V9080



DANGER

There is a risk of electrical shock.

Turn OFF power to the V9 series unit before performing steps 2 through 7 below.

1. Turn OFF power the V9 series unit.
2. Slide the battery holder cover in the direction of the arrow to open it.

Example: V9100

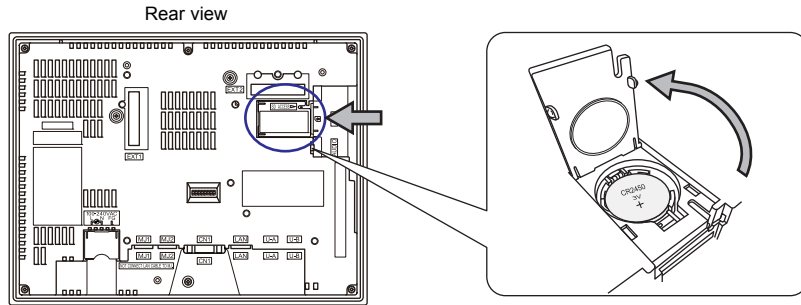

3. Insert a precision screwdriver into the gap on the right side of the battery and lift the battery out.

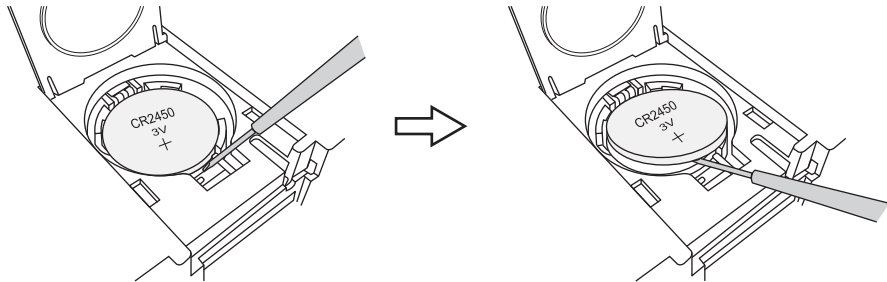

4. Remove the battery.
5. Slide a new battery left into the battery holder with the "+" side facing upward and then press the right side of the battery until it clicks.

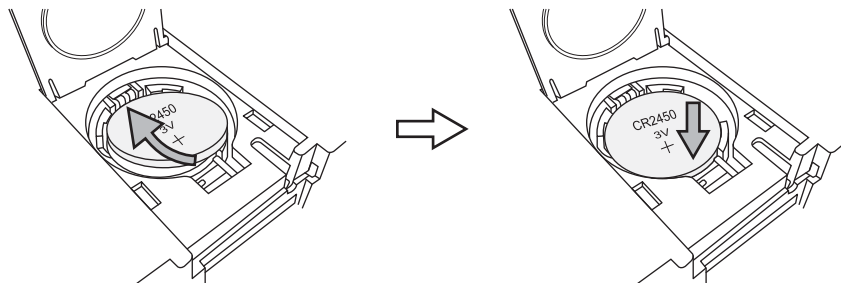

6. Close the battery holder cover.
7. Remove the caution sticker on the rear face of the V9 series unit (circled below). Write a date five years from the present date for battery replacement on the new caution sticker and attach the sticker.

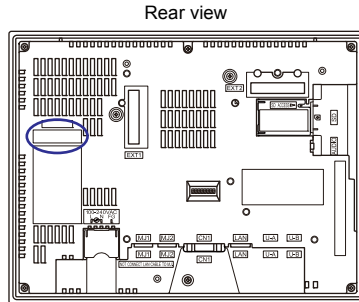

8. Turn power ON to the V9 series unit and check that the message “Battery changeover required” is cleared from the lower right of the screen in the Local mode.

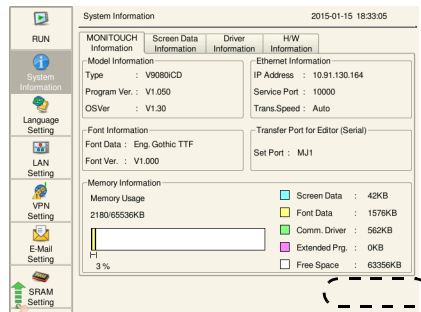

9. If a “*.RAM” backup file was saved, transfer it back to the V9 series unit.

V907xiW, V9060iTD

**DANGER**

Electrical shock hazard!

Turn OFF power to the V9 series unit before performing steps 2 through 6 below.

1. Turn OFF power to the V9 series unit.
2. Slide the battery holder cover in the direction of the arrow to remove it. The battery set in the socket is visible.

Example: V907xiW

Rear view

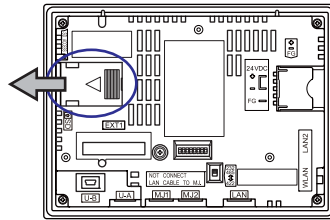

3. Disconnect the battery connector, and pull the battery toward the left to remove it from the socket.

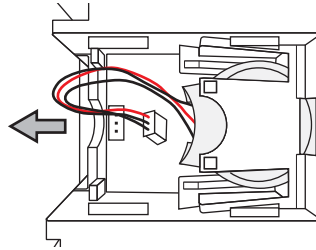

4. Insert the new battery into the socket with the side with the red wire facing down. Make sure that the battery is held in place by the retainers.

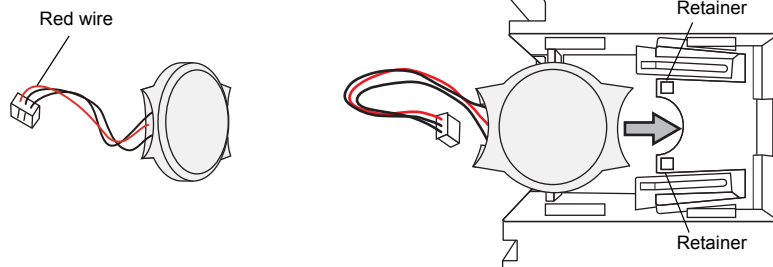

5. Attach the battery connector and close the battery holder cover.
6. Write a date five years from the present date for battery replacement on the new caution sticker and attach the sticker to an open area on the V9 series unit.

* Do not attach the sticker on air holes of the V9 series unit or optional units.

- Turn power ON to the V9 series unit and check that the message “Battery changeover required” is cleared from the lower right of the screen in Local mode.

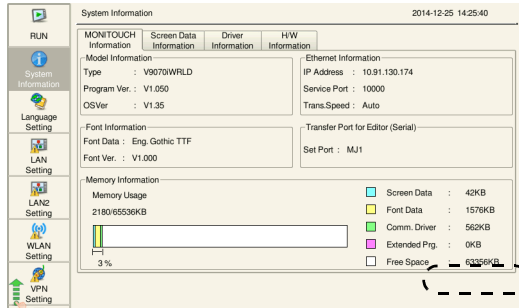

- If a “*.RAM” backup file was saved, transfer it back to the V9 series unit.

Notes on the Battery: EU Directive 2006/66/EC

According to the EU directive 2006/66/EC effective in EU countries, the battery supplied with the V9 series as well as the package box of the V9 series have the marking shown below:



CAUTION

- The marking shown above is effective only in EU countries.
- The details on the marking are designated in Article 20 “Information for end-users” and ANNEX II in EU directive 2006/66/EC.
- The marking indicates that the battery should be disposed of separately from general household waste.
- If element symbols are indicated below the marking, it means that the battery contains the specified heavy metal at a concentration exceeding the control value. The concentration control values are given below.
Hg: mercury (0.0005 %), Cd: cadmium (0.002 %), Pb: lead (0.004 %)
- The EU has determined the separating program for used batteries.
Dispose of used batteries properly at your local waste-disposal/recycling center.

5 Inspection and Maintenance

1. Inspection and Maintenance
2. Warranty Policy

1. Inspection and Maintenance

**DANGER**

Always turn OFF the power before conducting inspection or maintenance. Failure to do so could cause an electric shock or damage to the unit.

Daily Inspection

- Check that the screws on the V9 series unit are tightened firmly.
- Check that the connectors and terminal screws used for connection with other devices are tightened firmly.
- If the display surface or frame is dirty, wipe it with a soft cloth soaked in commercially available alcohol.
- Conduct periodical inspection once or twice a year. The number of inspections may be increased as necessary if facilities are relocated or modified, or the environment is hot, humid, or dusty.

Periodical Inspection

Inspect the following points periodically.

- Are the ambient temperature and humidity appropriate?
0 to +50 °C (0 to +40 °C for the V9150 series), 85 %RH or less
- Are the environmental conditions appropriate?
No excessive dust and no conductive dust
- Is there corrosive gas in the atmosphere?
- Is the source voltage in the allowable range?
AC power supply: 100 to 240 VAC –15 % to +10 %DC power supply: 24 VDC ± 10 %
- Are the V9 series mounting screws tightened firmly?
- Are the connectors and terminal screws used for connection with other devices tightened firmly?
- Has the coin-type lithium battery passed its replacement date?
Within about 5 years from the date of manufacture

2. Warranty Policy

Inquiries about Failure

Please direct inquiries about failure or repair to your local distributor.

Please provide information including the MONITOUCH model, serial number, symptoms of the failure, error messages (if shown), etc.

- * An inquiry form is provided on the final page (page 5-3) of this chapter. This form may be used for inquiries.

Warranty Period

The product is under warranty for one year after the date of purchase or delivery to the specified place. On the assumption that the maximum stock period of the product after manufacture is 6 months, the warranty period is limited to 18 months (checked by the serial number) after manufacture. When a warranty period is specified in the contract, however, the period in the contract takes precedence.

Free-of-charge Repair

If the product fails before the expiry of the warranty, it will be repaired free of charge.

However, repair of any failure resulting from the causes below will be chargeable even within the warranty period.

- Breakage of or damage to the appearance (case or surface sheet), touch switches, LCD, or other components due to dropping, impact, or mishandling
- End of service life of the LCD or backlight
- Fusion of a printed circuit board pattern associated with connection to external devices, or fusion of a pattern in the terminal block or connector section of a printed circuit board caused by short-circuiting of an external load circuit.
- Overvoltage or different voltage applied due to wiring mistakes (power supply terminal, external communication terminal, or other terminal blocks)
- Failure caused by a lightning surge
- Failure due to the entry of conductive substances, water, solvent, particles, etc. under inappropriate environmental conditions
- Failure due to inappropriate environmental conditions (e.g. corrosive gas or high humidity)
- Failure due to vibration or impact exceeding the specified level
- Disassembly and modification by the customer or failure obviously resulting from improper handling by the customer

Chargeable Repair

Any failure that occurs after the expiry of the warranty or that does not satisfy the requirements for free-of-charge repair will be repaired on a chargeable basis.

Inquiry Form

Your name			
Company name			
Contact	TEL		FAX
	Email		
Model code *1			Ser. No. *1
MONITOUCH version *2	Program version:		OS version:
Driver information *2	Maker, model name:		Version:
Purchased from: (Distributor)			
Person in charge		Date of purchase	
Symptoms			
(Please describe the symptoms of the failure and also include any displayed error messages.)			

*1 See the label on the back of the unit for the model code and serial number (nine digits plus one letter of the alphabet).

*2 Enter the version if it can be verified.

The version is displayed by selecting [System Information] in the Local mode of the V9 series unit.

For information on the Local mode, refer to the separate V9 Series Troubleshooting/Maintenance Manual.

MEMO

Please use this page freely.

Hakko Electronics Co., Ltd.
www.monitouch.com

Sales 890-1, Kamikashiwano-machi, Hakusan-shi, Ishikawa,
924-0035 Japan
TEL +81-76-274-2144 FAX +81-76-274-5136