

# MONITOUCH

## Reference Manual [1]



## Record of Revisions

Reference numbers are shown at the bottom left corner on the back cover of each manual.

Printing Date	Reference No.	Revised Contents
June, 2014	1065NE0	First edition
February, 2015	1065NE1	Second edition <ul style="list-style-type: none"> <li>• Chapter 1 \$s1674, Added \$s device memory (data transfer service, SYS (GET_SMPL) / SAMPLE macros)</li> <li>• Chapter 2 Overlaps, area transparency</li> <li>• Chapter 3 Switch functions, switching to Local mode, 80 Compatible HEX Key, 80 Compatible HEX Key Change</li> <li>• Chapter 7 Trend parts (real time), background operations</li> <li>• Chapter 11 Animation</li> <li>• Chapter 15 Recipes, semicolon delimiter, recipe switches, selection during execution (filtering window)</li> <li>• Chapter 16 Printing, added printer models (PR201, ESC-P, CBM292/293, MR-400)</li> <li>• Windows fonts, setting for smoothing edges</li> <li>• Partial modifications</li> <li>• Revisions for new print</li> </ul>
November, 2015	1065NE2	Third edition <ul style="list-style-type: none"> <li>• Chapter 7 Trend parts, [Use Calculation Operation]</li> <li>• Chapter 16 Printing, added PDF filenames for data sheets and time stamp selection</li> <li>• Partial modifications</li> </ul>



# Preface

Thank you for selecting the MONITOUCH V9 series.

For correct setup of the V9 series, you are requested to read through this manual to understand more about the product.

For details on other operating procedures for the V9 series, refer to the following related manuals.

Manual Name	Contents	Reference No.
V9 Series Reference Manual [1]	Explains the functions and operation of the V9 series.	1065NE
V9 Series Reference Manual [2]		1066NE
V9 Series Setup Manual	Explains the installation procedure of V-SFT version 6, the creation process of simple screen programs as well as how to transfer a created screen program using V-SFT version 6.	1067NE
V9 Series Troubleshooting/Maintenance Manual	Provides an error list and explains the operating procedures for the V9 series.	1068NE
V9 Series Training Manual Beginner's Guide	Explains the screen creation process using V-SFT version 6 with examples in detail.	1069NE
V9 Series Training Manual Practical Guide		1070NE
V9 Series Macro Reference	Provides an overview of macros of V-SFT version 6 and explains macro editor operations and macro command descriptions in detail.	1071NE
V9 Series Operation Manual	Explains the configuration of V-SFT version 6, the editing process of each part and limitations regarding operation in detail.	1072NE
V9 Series Connection Manual [1]	Explains the connection and communication parameters for the V9 series and controllers in detail. Included Makers ALLEN BRADLEY, Automationdirect, Azbil, Baumuller, BECKHOFF, CHINO, CIMON, DELTA, DELTA TAU DATA SYSTEMS, EATON Cutler-Hammer, EMERSON, FANUC, FATEK AUTOMATION, FUFENG, Fuji Electric, Gammaflux, GE Fanuc, Hitachi, Hitachi Industrial Equipment Systems	2210NE
V9 Series Connection Manual [2]	Explains the connection and communication parameters for the V9 series and controllers in detail. Included Makers IAI, IDEC, JTEKT, KEYENCE, KOGANEI, KOYO ELECTRONICS, LS, MITSUBISHI ELECTRIC, MODICON, MOELLER, M-SYSTEM, OMRON, Oriental Motor, Panasonic, RKC, RS Automation	2211NE
V9 Series Connection Manual [3]	Explains the connection and communication parameters for the V9 series and controllers in detail. Included Makers SAIA, SAMSUNG, SanRex, SANMEI, SHARP, SHIMADEN, SHINKO TECHNOS, Siemens, SINFONIA TECHNOLOGY, TECO, Telemecanique, TOHO, TOSHIBA, TOSHIBA MACHINE, TURCK, UNIPULSE, UNITRONICS, VIGOR, WAGO, XINJE, YAMAHA, Yaskawa Electric, Yokogawa Electric, MODBUS, Barcode Reader, Slave Communication Function, Universal Serial Communication	2212NE
V9 Series Hardware Specifications	Explains hardware specifications and precautions when handling the V9 series.	2023NE

For details on devices including PLCs, inverters, and temperature controllers, refer to the manual for each device.

## Notes:

1. This manual may not, in whole or in part, be printed or reproduced without the prior written consent of Hakko Electronics Co., Ltd.
2. The information in this manual is subject to change without prior notice.
3. Windows and Excel are registered trademarks of Microsoft Corporation in the United States and other countries.
4. All other company names or product names are trademarks or registered trademarks of their respective holders.
5. This manual is intended to give accurate information about MONITOUCH hardware. If you have any questions, please contact your local distributor.

# Notes on Safe Usage of MONITOUCH

In this manual, you will find various notes categorized under the following levels with the signal words "DANGER" and "CAUTION".

 **DANGER** Indicates an imminently hazardous situation which, if not avoided, will result in death or serious injury.

 **CAUTION** Indicates a potentially hazardous situation which, if not avoided, may result in minor or moderate injury and could cause property damage.

Note that there is a possibility that items listed with  **CAUTION** may have serious ramifications.

## **DANGER**

- Never use the output signal of the V9 series for operations that may threaten human life or damage the system, such as signals used in case of emergency. Please design the system so that it can cope with a touch switch malfunction. A touch switch malfunction may result in machine accidents or damage.
- Turn off the power supply when you set up the unit, connect new cables, or perform maintenance or inspections. Otherwise, electrical shock or damage may occur.
- Never touch any terminals while the power is on. Otherwise, electrical shock may occur.
- You must cover the terminals on the unit before turning the power on and operating the unit. Otherwise, electrical shock may occur.
- The liquid crystal in the LCD panel is a hazardous substance. If the LCD panel is damaged, do not ingest the leaked liquid crystal. If leaked liquid crystal makes contact with skin or clothing, wash it away with soap and water.
- Never disassemble, recharge, deform by pressure, short-circuit, reverse the polarity of the lithium battery, nor dispose of the lithium battery in fire. Failure to follow these conditions will lead to explosion or ignition.
- Never use a lithium battery that is deformed, leaking, or shows any other signs of abnormality. Failure to follow these conditions will lead to explosion or ignition.
- Switches on the screen are operable even when the screen has become dark due to a faulty backlight or when the backlight has reached the end of its service life. If the screen is dark and hard to see, do not touch the screen. Otherwise, a malfunction may occur resulting in machine accidents or damage.

## **CAUTION**

- Check the appearance of the unit when it is unpacked. Do not use the unit if any damage or deformation is found. Failure to do so may lead to fire, damage, or malfunction.
- For use in a facility or as part of a system related to nuclear energy, aerospace, medical, traffic equipment, or mobile installations, please consult your local distributor.
- Operate (or store) the V9 series under the conditions indicated in this manual and related manuals. Failure to do so could cause fire, malfunction, physical damage, or deterioration.
- Observe the following environmental restrictions on use and storage of the unit. Otherwise, fire or damage to the unit may result.
  - Avoid locations where there is a possibility that water, corrosive gas, flammable gas, solvents, grinding fluids, or cutting oil can come into contact with the unit.
  - Avoid high temperatures, high humidity, and outside weather conditions, such as wind, rain, or direct sunlight.
  - Avoid locations where excessive dust, salt, and metallic particles are present.
  - Avoid installing the unit in a location where vibrations or physical shocks may be transmitted.
- Equipment must be correctly mounted so that the main terminal of the V9 series will not be touched inadvertently. Otherwise, an accident or electric shock may occur.
- Tighten the mounting screw on the fixtures of the V9 series to an equal torque of 0.6 N·m. Excessive tightening may distort the panel surface. Loose mounting screws may cause the unit to fall down, malfunction, or short-circuit.
- Check periodically that terminal screws on the power supply terminal block and fixtures are firmly tightened. Loosened screws or nuts may result in fire or malfunction.
- Tighten the terminal screws on the power supply terminal block of the V9 series to an equal torque of 7.1 to 8.8 inch-lbf (0.8 to 1.0 N·m). Improper tightening of screws may result in fire, malfunction, or other serious trouble.
- The V9 series has a glass screen. Do not drop the unit or impart physical shocks to the unit. Otherwise, the screen may be damaged.
- Correctly connect cables to the terminals of the V9 series in accordance with the specified voltage and wattage. Overvoltage, overwattage, or incorrect cable connection could cause fire, malfunction, or damage to the unit.
- Always ground the V9 series. The FG terminal must be used exclusively for the V9 series with the level of grounding resistance less than 100 Ω. Otherwise, electric shock or a fire may occur.
- Prevent any conductive particles from entering the V9 series. Failure to do so may lead to fire, damage, or malfunction.
- After wiring is finished, remove the paper used as a dust cover before starting operation of the V9 series. Operation with the dust cover attached may result in accidents, fire, malfunction, or other trouble.

## CAUTION

- Do not attempt to repair the V9 series yourself. Contact Hakko Electronics or the designated contractor for repairs.
- Do not repair, disassemble, or modify the V9 series. Hakko Electronics Co., Ltd. is not responsible for any damages resulting from repair, disassembly, or modification of the unit that was performed by an unauthorized person.
- Do not use sharp-pointed tools to press touch switches. Doing so may damage the display unit.
- Only experts are authorized to set up the unit, connect cables, and perform maintenance and inspection.
- Lithium batteries contain combustible material such as lithium and organic solvents. Mishandling may cause heat, explosion, or ignition resulting in fire or injury. Read the related manuals carefully and correctly handle the lithium battery as instructed.
- Take safety precautions during operations such as changing settings when the unit is running, forced output, and starting and stopping the unit. Any misoperations may cause unexpected machine movement, resulting in machine accidents or damage.
- In facilities where the failure of the V9 series could lead to accidents that threaten human life or other serious damage, be sure that such facilities are equipped with adequate safeguards.
- When disposing of the V9 series, it must be treated as industrial waste.
- Before touching the V9 series, discharge static electricity from your body by touching grounded metal. Excessive static electricity may cause malfunction or trouble.
- Insert an SD card into MONITOUCH in the same orientation as pictured on the unit. Failure to do so may damage the SD card or the slot on the unit.
- The SD card access LED flashes red when the SD card is being accessed. Never remove the SD card or turn off power to the unit while the LED is flashing. Doing so may destroy the data on the SD card. Check that the LED has turned off before removing the SD card or turning off the power to the unit.
- Be sure to remove the protective sheet that is attached to the touch panel surface at delivery before use. If used with the protective sheet attached, MONITOUCH may not recognize touch operations or malfunctions may occur.
- When using an analog resistive-film type V9 series unit, do not touch two positions on the screen at the same time. If two or more positions are pressed at the same time, the switch located between the pressed positions may be activated.
- When using a capacitive V9 series unit, take note of the following cautions.
  - Use a Class 2 power supply for a 24-VDC unit. If an unstable power supply is used, MONITOUCH may not recognize touch operations or malfunctions may occur.
  - Capacitive touch panel types support two-point touch operations. If a third point is touched, the touch operation will be cancelled.
  - Capacitive touch panel types are prone to the influence of conductive material. Do not place conductive material such as metals near the touch panel surface and do not use the panel if it is wet. Otherwise, malfunctions may occur.

### [General Notes]

- Never bundle control cables or input/output cables with high-voltage and large-current carrying cables such as power supply cables. Keep control cables and input/output cables at least 200 mm away from high-voltage and large-current carrying cables. Otherwise, malfunction may occur due to noise.
- When using the V9 series in an environment where a source of high-frequency noise is present, it is recommended that the FG shielded cable (communication cable) be grounded at each end. However, when communication is unstable, select between grounding one or both ends, as permitted by the usage environment.
- Be sure to plug connectors and sockets of the V9 series in the correct orientation. Failure to do so may lead to damage or malfunction.
- If a LAN cable is inserted into the MJ1 or MJ2 connector, the device on the other end may be damaged. Check the connector names on the unit and insert cables into the correct connectors.
- Do not use thinners for cleaning because it may discolor the V9 series surface. Use commercially available alcohol.
- If a data receive error occurs when the V9 series unit and a counterpart unit (PLC, temperature controller, etc.) are started at the same time, read the manual of the counterpart unit to correctly resolve the error.
- Avoid discharging static electricity on the mounting panel of the V9 series. Static charge can damage the unit and cause malfunctions. Discharging static electricity on the mounting panel may cause malfunction to occur due to noise.
- Avoid prolonged display of any fixed pattern. Due to the characteristic of liquid crystal displays, an afterimage may occur. If prolonged display of a fixed pattern is expected, use the backlight's auto OFF function.
- The V9 series is identified as a class-A product in industrial environments. In the case of use in a domestic environment, the unit is likely to cause electromagnetic interference. Preventive measures should thereby be taken appropriately.

### [Notes on the LCD]

Note that the following conditions may occur under normal circumstances.

- The response time, brightness, and colors of the V9 series may be affected by the ambient temperature.
- Tiny spots (dark or luminescent) may appear on the display due to the characteristics of liquid crystal.
- There are variations in brightness and color between units.

[Notes on Capacitive Touch Panels]

- Touch panel operability may not be optimal if used with dry fingers or skin. In such a case, use a capacitive stylus pen.
- Periodically clean the touch panel surface for optimum touch operations.

When cleaning, take note of the following points.

<When cleaning>

- The panel surface is made of glass. Be sure to clean the surface gently with a cloth or sponge. Otherwise, you may scratch or damage the glass.
- Take care not to let cleaning detergent seep into the touch panel unit.  
Do not directly apply or spray cleaning detergent on the panel surface.

[Notes on Wireless LAN]

For details regarding supported wireless LAN standards, radio law certifications, and countries where wireless LAN can be used, refer to the "V9 Series About Wireless LAN" manual and the "V9 Series Hardware Specifications" manual provided with the V9 series unit at delivery.

# Contents

---

## Preface

## 1 System

### 1.1 System Settings

1.1.1	System Setting .....	1-1
1.1.2	Unit Setting .....	1-2
	Edit Model Selection.....	1-2
	Multi-language Setting .....	1-3
	Unit Setting .....	1-5
1.1.3	Communication Setting .....	1-21
	Hardware Setting.....	1-21
1.1.4	Common Setting .....	1-25
	Global Setting.....	1-25
1.1.5	Settings .....	1-26
	Date and Time Display Setting .....	1-26

### 1.2 Process Cycle

1.2.1	Setting the Processing Cycle .....	1-27
1.2.2	Processing Sequence in the V9 Series .....	1-28
	One-cycle Processing.....	1-29
1.2.3	If Communication is Slow .....	1-30
	Methods for Creating Screens.....	1-30
	Others.....	1-30

### 1.3 List of Internal Device Memory

1.3.1	Types of Internal Device Memory .....	1-31
	User Device Memory.....	1-31
	System Device Memory.....	1-31
1.3.2	System Device Memory Details .....	1-32

## 2 Overlap

### 2.1 Overview

2.1.1	Overlap Displays .....	2-1
2.1.2	Overlap Display Formats .....	2-3
	Normal Overlap.....	2-3
	Call-overlap.....	2-4
	Multi-overlap.....	2-5
	Global Overlap .....	2-6
2.1.3	Overlap Auxiliary Functions .....	2-7
	System Buttons.....	2-7
	Display Transparency .....	2-7

### 2.2 Normal Overlap

2.2.1	Creation Procedure .....	2-8
2.2.2	Detailed Settings .....	2-9
2.2.3	Show/Hide Settings .....	2-11

### 2.3 Call-overlap

2.3.1	Creation Procedure .....	2-14
2.3.2	Detailed Settings .....	2-15
2.3.3	Show/Hide Settings .....	2-16

2.4	Multi-overlap	
2.4.1	Creation Procedure .....	2-17
2.4.2	Detailed Settings .....	2-18
2.4.3	Show/Hide Settings .....	2-20
2.5	Global Overlap	
2.5.1	Creation Procedure .....	2-23
2.5.2	Detailed Settings .....	2-25
2.5.3	Show/Hide Settings .....	2-26
2.5.4	Notes .....	2-28
2.6	Display Transparency	
2.6.1	Overview .....	2-29
2.6.2	Setting Procedure .....	2-29
3	Switch	
3.1	Switch	
3.1.1	Overview .....	3-1
	Basic Function of Switches .....	3-1
	Lamps in Switches .....	3-3
3.1.2	Setting Examples .....	3-4
	Setting the PLC bit to ON .....	3-4
	Changing Screens .....	3-5
3.1.3	Detailed Settings .....	3-6
3.1.4	Basic Function of Switches .....	3-19
	List of Functions .....	3-19
	Switch Function Examples .....	3-23
3.1.5	Flowchart .....	3-25
3.1.6	Coordinate Output .....	3-29
3.1.7	Notes .....	3-30
	Placement .....	3-30
3.2	Scroll Bars	
3.2.1	Overview .....	3-31
3.2.2	Setting Examples .....	3-32
3.2.3	Detailed Settings .....	3-35
3.2.4	Notes .....	3-37
3.3	Slider Switch	
4	Lamp	
4.1	Overview	
4.2	Setting Examples	
	Using Bit Lamps.....	4-2
	Placing 128 Pattern Lamps.....	4-3
4.3	Detailed Settings	
4.4	Draw Mode	
5	Data Display	
5.1	Numerical Display	
5.1.1	Overview .....	5-1
5.1.2	Setting Examples .....	5-4
	Monitoring PLC Device Memory.....	5-4
5.1.3	Detailed Settings .....	5-5
5.1.4	Real Numbers (Floating Point Numbers) .....	5-17

5.2	Character Display	
5.2.1	Overview .....	5-19
5.2.2	Detailed Settings .....	5-20
5.3	Message Display	
5.3.1	Overview .....	5-28
5.3.2	Detailed Settings .....	5-29
5.4	Table Data Display	
5.4.1	Overview .....	5-33
5.4.2	Table Data Settings .....	5-33
5.4.3	Numerical Data Display Settings .....	5-35
5.4.4	Character Display Settings .....	5-40
5.4.5	Message Display Settings .....	5-43
5.4.6	Text Settings .....	5-44
5.5	Notes	
5.5.1	Placing Switches or Lamps Overlaying Other Switches or Lamps .....	5-45

## 6 Entry

6.1	Numerical Data Entry	
6.1.1	Overview .....	6-1
6.1.2	Setting Examples .....	6-2
	Placing an Entry Target and Keypad on the Screen.....	6-2
	Showing the Keypad Only When Necessary.....	6-4
	Placing an Entry Display (Value Entry).....	6-5
	Specifying an Entry Range.....	6-6
	Slider Switch.....	6-7
6.1.3	Detailed Settings .....	6-8
	Keypad .....	6-8
	Entry Target.....	6-15
	Slider Switch.....	6-19
6.2	Character Input	
6.2.1	Overview .....	6-20
6.2.2	Setting Examples .....	6-22
	Placing an Entry Target and Keyboard on the Screen.....	6-22
	Showing the Keyboard Only When Necessary.....	6-24
	USB Keyboard Entry.....	6-25
	Password Input .....	6-26
6.2.3	Detailed Settings .....	6-28
	Keyboard.....	6-28
	Entry Target.....	6-30
6.3	Convenient Functions	
6.3.1	Item Select Function .....	6-32
	Overview.....	6-32
	Item Select Function with a Switch .....	6-32
	Item Select with [Input Cursor Movement Control Device] .....	6-33

## 7 Trends

7.1	Overview	
	Historical Display.....	7-1
	Real Time Display.....	7-1

7.2	Historical Display	
7.2.1	Logging Server .....	7-2
	Setting Example.....	7-3
	Detailed Settings.....	7-7
7.2.2	Graph Display .....	7-15
	Location of Setting.....	7-16
	Detailed Settings.....	7-16
	Notes .....	7-23
7.2.3	Data Display .....	7-24
	Location of Setting.....	7-25
	Detailed Settings.....	7-25
	Log Printing.....	7-29
7.3	Real Time Display	
7.3.1	Location of Settings .....	7-32
7.3.2	Detailed Settings .....	7-32
7.3.3	Plot Point Pitch .....	7-38
7.3.4	Display Method .....	7-42
7.3.5	Asynchronous Display of Multiple Trend Graphs .....	7-43
7.3.6	Background Update .....	7-46

## 8 Alarm

8.1	Overview	
8.2	Alarm Server	
8.2.1	Alarm Server .....	8-7
8.2.2	Alarm Block Settings .....	8-8
8.2.3	Action When Alarms Occur .....	8-18
8.3	Date and Time Display Setting	
8.4	Alarm Parts	
8.4.1	Detailed Settings .....	8-29

## 9 Graph Display

9.1	Bar Graph	
9.1.1	Overview .....	9-1
9.1.2	Setting Examples .....	9-2
	Displaying Current Values (Standard Display).....	9-2
	Displaying Deviation from a Reference Value to the Current Value (Deviation Display) .....	9-4
9.1.3	Detailed Settings .....	9-6
9.2	Pie Graph	
9.2.1	Overview .....	9-11
9.2.2	Setting Examples .....	9-12
	Displaying Current Values (Standard Display).....	9-12
	Displaying Deviation from a Reference Value to the Current Value (Deviation Display) .....	9-14
9.2.3	Detailed Settings .....	9-16
9.3	Closed Area Graphs	
9.3.1	Overview .....	9-21
9.3.2	Setting Examples .....	9-22
	Displaying Current Values .....	9-22
9.3.3	Detailed Settings .....	9-24



9.4	Panel Meter	
9.4.1	Overview .....	9-27
9.4.2	Setting Examples .....	9-28
	Displaying Current Values .....	9-28
9.4.3	Detailed Settings .....	9-31
	Alarm .....	9-37
	Num. Display .....	9-39
	Detail.....	9-42
9.5	Statistic Bar Graph	
9.5.1	Overview .....	9-47
9.5.2	Setting Examples .....	9-48
	Displaying a Bar Graph of the Ratio of D100 to D104 Values.....	9-48
	Displaying a Numerical Data Display of the Ratio of D100 to D104 Values.....	9-49
9.5.3	Detailed Settings .....	9-51
9.6	Statistic Pie Graph	
9.6.1	Overview .....	9-53
9.6.2	Setting Examples .....	9-54
	Displaying a Pie Graph of the Ratio of D100 to D103 Values .....	9-54
	Displaying a Numerical Data Display of the Ratio of D100 to D103 Values.....	9-55
9.6.3	Detailed Settings .....	9-57

## 10 Calendar

10.1	Overview	
10.2	Time Display	
10.2.1	Overview .....	10-3
10.2.2	Setting Examples .....	10-4
	Displaying the PLC Calendar .....	10-4
	Displaying the Built-in V9 Series Calendar .....	10-6
	Display Using the Time Display Format Setting.....	10-8
	Displaying Seconds Data Stored in Device Memory in Timer Format .....	10-10
10.2.3	Detailed Settings .....	10-11
10.3	Calendar	
10.3.1	Detailed Settings .....	10-14
10.4	Calendar Data Correction	
10.4.1	Correcting in the Control Area .....	10-18
10.4.2	Correcting Using a Macro .....	10-19
10.4.3	Correcting in Local Mode .....	10-19

## 11 Graphics and Animation

11.1	Graphics	
11.1.1	Overview .....	11-1
11.1.2	Detailed Settings .....	11-3
	Operation Select: Switch.....	11-3
	Operation Select: Device (No. Designation).....	11-5
	Operation Select: Device (Bit Designation).....	11-8
11.1.3	Graphic Display Color .....	11-12
11.1.4	Graphic Library (Parameter Settings) .....	11-14

11.2	Animation	
11.2.1	Overview .....	11-18
11.2.2	Setting Example .....	11-19
11.2.3	Detailed Settings .....	11-24
	Registering Animation .....	11-24
	Animation Settings.....	11-26
11.2.4	Notes .....	11-34

## 12 Message

12.1	Message Mode	
12.1.1	Overview .....	12-1
12.1.2	Setting Examples .....	12-4
	Displaying Messages (Page Blocks).....	12-4
12.1.3	Detailed Settings .....	12-7
12.1.4	Registering Messages .....	12-15
12.1.5	Registering Page Blocks .....	12-16
12.1.6	Registering Direct Blocks .....	12-17
12.2	Displaying Comments	
12.2.1	Overview .....	12-18
12.2.2	Setting Examples .....	12-20
	Displaying Comments (Number Designation).....	12-20
12.2.3	Detailed Settings .....	12-22
12.2.4	Registering Comments .....	12-25

## 13 Others

13.1	Memo Pad	
13.1.1	Overview .....	13-1
13.1.2	Usage Example .....	13-2
13.1.3	Detailed Settings .....	13-3
13.1.4	Memo Pad Data Storage .....	13-5
	Saving to a Storage Device .....	13-5

## 14 Item Show/Hide Function

14.1	Overview	
14.2	Setting Examples	
14.2.1	Displaying Items when the Corresponding Bit Turns ON .....	14-2
14.2.2	Displaying Items Using Device Memory Values .....	14-3
14.2.3	Displaying Items Using the Level of the Security Function .....	14-4
14.3	Detailed Settings	
14.4	Checking Settings	

## 15 Recipes

15.1	Overview	
15.1.1	Recipes .....	15-1
15.1.2	Recipe Function .....	15-2
	Structure.....	15-2
	Operations.....	15-3

15.2	Creating Recipe Data (BIN/CSV Files)	
15.2.1	Using the Screen Configuration Software .....	15-4
	Setting Procedure.....	15-4
15.2.2	Creating Recipes Using Excel (CSV Files Only) .....	15-7
	Setting Procedure.....	15-7
15.3	Reading Recipes in Units of Files When the PLC Bit Turns ON	
15.3.1	Conceptual Operation .....	15-9
15.3.2	Setting Procedure .....	15-9
15.3.3	Operating Procedure .....	15-9
15.4	Reading Recipes in Units of Files with Switch Operations	
15.4.1	Conceptual Operation .....	15-10
15.4.2	Setting Procedure .....	15-10
15.4.3	Operating Procedure .....	15-10
	Reading Out by Searching for Filenames (Filtering) .....	15-11
15.5	Reading Recipes in Units of Records	
15.5.1	Specifying Record Numbers for Reading .....	15-13
	Conceptual Operation.....	15-13
	Setting Procedure.....	15-13
	Operating Procedure.....	15-13
15.6	Writing Recipes in Units of Records	
15.6.1	Specifying Record Names for Writing .....	15-14
	Conceptual Operation.....	15-14
	Setting Procedure.....	15-14
	Operating Procedure.....	15-14
15.6.2	Creating New Records .....	15-15
	Conceptual Operation.....	15-15
	Setting Procedure.....	15-15
	Operating Procedure.....	15-15
	Difference in Operation Between Record Name Designation and Record Number Designation .....	15-16
15.7	Checking that the Recipe Function is Operating Correctly	
15.7.1	Conceptual Operation .....	15-17
15.7.2	Setting Procedure .....	15-17
15.7.3	Checking Procedure .....	15-17
15.8	Detailed Settings	
15.8.1	Location of Settings .....	15-18
15.8.2	Recipe Settings (0 to 255) .....	15-18
	[Standard Operation] Tab Window.....	15-18
	[File Format] Tab Window .....	15-19
	[Recipe Data] Tab Window.....	15-20
	[Transfer Command] Tab Window .....	15-21
15.9	Switch Operated Functions	
15.9.1	Switch Types .....	15-22
	Filter .....	15-22
	New .....	15-24
15.10	Specifications	
	Notes .....	15-27
	Recipe Parts.....	15-28

## 16 Print

### 16.1 Overview

16.1.1	Compatible Printers .....	16-2
16.1.2	EPSON Printers that Support "ESC/P-R" Control Codes .....	16-3
16.1.3	PictBridge Printers .....	16-5
16.1.4	PR201 and ESC-P Printers .....	16-9
16.1.5	CBM292/293 Printer .....	16-12
16.1.6	Sato's MR-400 Barcode Printer .....	16-14

### 16.2 Hard copy

16.2.1	Overview .....	16-15
16.2.2	Printing .....	16-15

### 16.3 Printing Data Sheets

16.3.1	Overview .....	16-17
16.3.2	Detailed Settings .....	16-19
16.3.3	Printing .....	16-23

### 16.4 Connecting to a Sato MR-400 Barcode Printer

16.4.1	Connection Method .....	16-26
16.4.2	Notes on Memory Cards .....	16-27
	Memory Cards.....	16-27
16.4.3	Format Tables .....	16-28
16.4.4	Printing .....	16-36

## 17 Barcode

### 17.1 Overview

### 17.2 Setting Examples

### 17.3 Detailed Settings

### 17.4 Wiring

17.4.1	USB Connection .....	17-7
17.4.2	Serial Connection .....	17-7

### 17.5 Notes

# 1 System

---

1.1 System Settings

1.2 Process Cycle

1.3 List of Internal Device Memory

## 1.1 System Settings

### 1.1.1 System Setting

System settings cover a variety of settings including those initially required for the V9 series unit to communicate with the PLC, unit settings, and screen program settings. This section only describes the settings important for initial setup. For details, refer to the relevant item.



Before transferring a screen program to the V9 series unit, be sure to check the system settings.

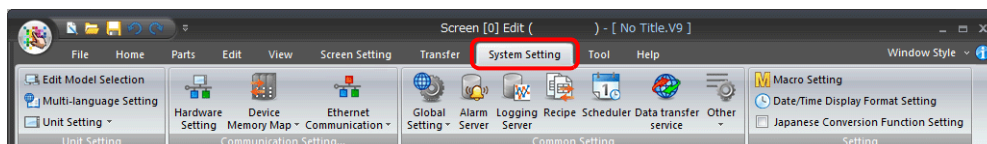

Group	Item		Refer to
Unit Setting	Edit Model Selection		<a href="#">"Edit Model Selection" page 1-2</a>
	Multi-language Setting		<a href="#">"Multi-language Setting" page 1-3</a>
	Unit Setting	SRAM/Clock	<a href="#">"SRAM/Clock" page 1-5</a>
		Backlight	<a href="#">"Backlight" page 1-7</a>
		Buzzer	<a href="#">"Buzzer" page 1-8</a>
		System/Mode Switch	<a href="#">"System/Mode Switch" page 1-9</a>
		Blink/Flash	<a href="#">"Blink/Flash" page 1-9</a>
		Overlap	<a href="#">"2 Overlap"</a>
		Video/RGB	V9 Series Reference Manual 2 1.1 Video/RGB Display
		Sound	V9 Series Reference Manual 2 2 Sound
General Setting		<a href="#">"General Settings" page 1-10</a>	
Local Mode	<a href="#">"Local Mode Prohibition Setting" page 1-19</a>		
GD-80E/V609E Compatibility Setting	<a href="#">"GD-80E/V609E Compatibility Setting" page 1-20</a>		
Communication Setting	Hardware Setting		<a href="#">"Hardware Setting" page 1-21</a>
	Device Memory Map		V9 Series Reference Manual 2 11 Device Memory Map
	Ethernet Communication	Local Port Address	V9 Series Reference Manual 2 6 Ethernet Communication Function
		Network Table	
		E-Mail	
FTP Server			
Common Setting	Global Setting	Global Function Switch Setting	<a href="#">"Global Function Switch Setting" page 1-25</a>
		Global Overlap Setting	<a href="#">"2.5 Global Overlap"</a>
	Alarm Server		<a href="#">"8.2 Alarm Server"</a>
	Logging Server		<a href="#">"7.2.1 Logging Server"</a>
	Recipe		<a href="#">"15 Recipes"</a>
	Scheduler		V9 Series Reference Manual 2 3 Scheduler
	Data transfer service		V9 Series Reference Manual 2 6.11 Data Transfer Service
	Other	Storage Setting	V9 Series Reference Manual 2 8 Storage Device
		MES Setting	6.7 MES Interface Function
		Operation log Setting	4 Operation Log
		Security Setting	5 Security
		Network Camera Table Setting	1.2 Network Camera
Time Display Format Setting		<a href="#">"Time display format setting" page 10-12</a>	
Flowing Message		<a href="#">"8.2 Alarm Server"</a>	

Group	Item		Refer to
Common Setting	Other	PDF Viewer Setting	V9 Series Reference Manual 2 13 PDF Viewer
		Video Player settings	V9 Series Reference Manual 2 15 Video Player
Setting	Macro Setting		V9 Series Macro Reference Manual
	Date and Time Display Setting		<a href="#">"8.3 Date and Time Display Setting"</a>
	Japanese Conversion Function Setting		-

## 1.1.2 Unit Setting

This section explains the items in the [Unit Setting] group.

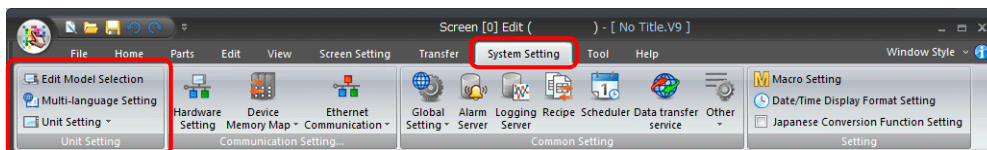

For information on other settings, refer to ["1.1.1 System Setting" page 1-1](#).

### Edit Model Selection

Select the model of the V9 series for which you wish to configure a screen program.

Location of setting: [System Setting] → [Edit Model Selection] or [System Setting] → [Hardware Setting] → [Edit Model]

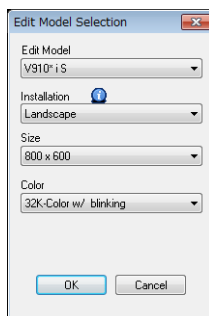

V9 Series Model	Edit Model	Installation	Size	Color
V9150iX	V915*iX	Landscape Portrait (Left 90) Portrait (Right 90)	1024 × 768	64K-Color w/o blinking 32K-Color w/ blinking
V9120iS	V912*iS		800 × 600	
V910xiW	V910*iW		1024 × 600	
V9100iS	V910*iS		800 × 600	
V9080iS	V908*iS		800 × 600	
V9100iC	V910*iC		640 × 480	
V9080iC	V908*iC		640 × 480	
V907xiW	V907*iW		800 × 480	
V9060iT	V906*iT		640 × 480	



The screen program of the V9 series unit cannot be converted into an earlier version (for example, V8 or V7 series).

## Multi-language Setting

Select the language for display on the V9 series unit.

Location of settings: [System Setting] → [Multi-language Setting].

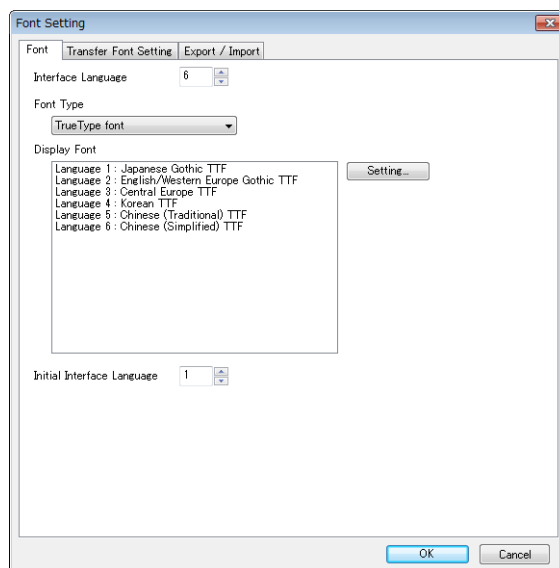

For details, refer to “9 Language Changeover” in the V9 Series Reference Manual 2.

Item	Description
Interface Language	Set the number of interface languages. 1 to 16 Example: Specifying “5” means Languages 1 to 5 can be set.
Font Type	Select either [TrueType font] or [Bitmap font].
Setting	Set the languages to use.
Initial Interface Language	Select the language to be displayed when the power is turned on. 1 to 16

## Font Type

Fonts are roughly divided into two types: TrueType fonts and bitmap fonts.

Because the mixed use of fonts is not permitted on MONITOUCH, select one font type in the [System Setting] → [Multi-language Setting] → [Font Setting] window when creating a screen program.

Type	Size Specification Method	Features	Image
TrueType font	Point specification	Supports smoothing. Note that TrueType fonts require more memory than bitmap fonts.	
Bitmap font	XY magnification factor specification	Font data designed in sizes of 16 × 16 dots and 32 × 32 dots (two-byte characters). This font type occupies less memory but is not suitable if a smoother-line typeface is required.	

Windows fonts  
No font data is stored on MONITOUCH but the fonts used on Windows, such as “Times New Roman” or “Arial”, are used as image data. Settings can be configured for each item.  
For details, refer to the V9 Series Operation Manual.



## Supported Language List

The following table lists the fonts and corresponding languages supported by the V9 series.

Font Setting <sup>*1</sup>		Supported Language	Supported Character Code	Remarks
TrueType font	Japanese Gothic TTF	Japanese, English	JIS level 1 to level 4 + ANK code	Code 8794 cannot be displayed
	Japanese Times TTF			
	English/Western Europe Gothic TTF	English, Icelandic, Irish, Italian, Dutch, Spanish, Danish, German, Norwegian, Portuguese, Finnish, Faroese, French, Swedish	CP1252 code	
	English/Western Europe Times TTF			
	Chinese (Traditional) TTF	Chinese (traditional), English	BIG5 code (A141 to F9FE) + ASCII code	Codes A344 to A373 cannot be displayed
	Chinese (Simplified) TTF	Chinese (simplified), English	GB2312 code (A1A1 to F7FE) + ASCII code	Codes A021 - A07E A6A1 - A6B8 A6C1 - A6D8 A7A1 - A7C0 A7D1 - A7F1 A8BB, A8BD, A8BE, A8C0 cannot be displayed
	Korean TTF	Hangul, English	KS code (A1A1 to FDFE) + ASCII code	Codes A2E6 and A2E7 cannot be displayed
	Central Europe TTF	Croatian, Czech, Hungarian, Polish, Romanian, Slovakian, Slovene, Hrvatska (Croatian)	CP1250 code	
	Cyrillic TTF	Russian, Ukrainian, Bulgarian, Kazakh, Uzbek, Azerbaijani	CP1251 code	
	Greek TTF	Greek	CP1253 code	
	Turkish TTF	Turkish	CP1254 code	
Baltic TTF	Estonian, Latvian, Lithuanian	CP1257 code		
Bitmap font	Japanese	Japanese, English	JIS level 1, level 2 + ANK code	
	Japanese 32	Japanese, English	JIS level 1 + ANK code	
	English/Western Europe	English, Icelandic, Irish, Italian, Dutch, Spanish, Danish, German, Norwegian, Portuguese, Finnish, Faroese, French, Swedish	ISO-8859-1: Latin1 (Extended ASCII code)	
	Chinese (Traditional)	Chinese (traditional), English	BIG5 code (A141 to C67E) + ASCII code	
	Chinese (Simplified)	Chinese (simplified), English	GB2312 code (A1A1 to FEFE) + ASCII code	
	Korean	Hangul, English	KS code (A1A2 to C8FE) + ASCII code	
	Central Europe	Croatian, Czech, Hungarian, Polish, Romanian, Slovakian, Slovene, Hrvatska (Croatian)	CP1250 code	
	Cyrillic	Russian, Ukrainian, Bulgarian, Kazakh, Uzbek, Azerbaijani	CP1251 code	
	Greek	Greek	CP1253 code	
	Turkish	Turkish	CP1254 code	
	Baltic	Estonian, Latvian, Lithuanian	CP1257 code	

\*1 Settings that mix TrueType fonts and bitmap fonts cannot be configured.

## Unit Setting

The settings to be configured on the V9 series unit are described below. Select the functions to use and configure the required settings.

Location of settings: [System Setting] → [Unit Setting].

### SRAM/Clock

Configure the following settings when using SRAM or the built-in clock of the V9 series unit.

Location of settings: [System Setting] → [Unit Setting] → [SRAM/Clock].

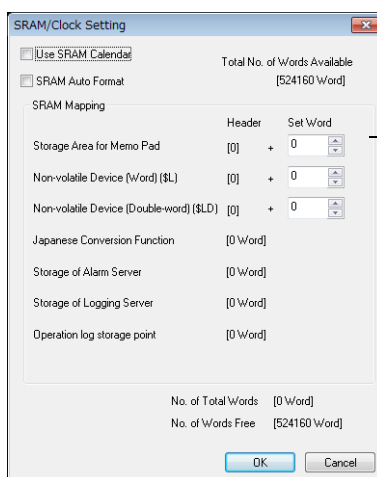

The contents of the SRAM area is retained by battery after power to the unit is turned off.

Item	Description	Refer to
Use SRAM Calendar	Set the reading target of the clock.  Selected Use the built-in clock of the V9 series unit.  Unselected Use the clock in the PLC.	"10 Calendar"
SRAM Auto Format	Set the SRAM format method.  Selected Perform auto-formatting.  Unselected Perform formatting on the [SRAM Setting] screen in Local mode.	"Formatting SRAM" page 1-6
Storage Area for Memo Pad	Allocates an area that stores the memo pad data.	"13.1 Memo Pad"
Non-volatile Device (Word) (\$L)	Allocates areas used by the addresses \$L (word area) and \$LD (double word area) in user device memory. The available range is determined by the specified device memory address.	"Non-volatile \$L (word) and non-volatile \$LD (double-word)" page 1-6
Non-volatile Device (Double-word) (\$LD)	Example: When the set number of words for \$L is 10, \$L0 to \$L9 can be used.	"Formatting SRAM" page 1-6
Japanese Conversion Function	When the Japanese conversion function is used, 18,728 words are allocated.	-
Storage of Logging server	When the logging server is used, the required number of words is allocated.	"7.2.1 Logging Server"
Storage of Alarm Server	When the alarm server is used, the required number of words is allocated.	"8.2.1 Alarm Server"
Operation log storage point	When operation logs are used, the required number of words is allocated.	V9 Series Reference Manual 2 4 Operation Log
No. of Total Words No. of Words Free	Indicates the number of used and free words with the current settings. Set the items within the number of words available.	-

## Non-volatile \$L (word) and non-volatile \$LD (double-word)

- Difference  
The difference between "Word" and "Double-word" is whether only the specified address (word) is guaranteed or two words (double-word) from the address are guaranteed when a power failure occurs.
- Data protection when a power failure occurs  
When a power failure occurs while writing data to \$L or \$LD, the data value just before writing is guaranteed. (In case of \$L, the top word of data just before writing is guaranteed; in case of \$LD, the top two words of data just before writing is guaranteed.)  
However, note that when performing processing where two or more words for \$L and three or more words for \$LD are written simultaneously, the data is not guaranteed.

Example: Character display, "BMOV" macro command, [Screen Setting] → [Screen Setting] → [PLC Device Transfer] etc.

- \*1 Use \$LD to access two word data. To verify whether writing was successful or not, check system device memory addresses \$s721 to \$s726.

Device Memory	Description	Device Type
\$s721	Writing result of \$L address where data was written last 0: Normal 1: Error	← V (writing from V9 to \$s)
\$s722	\$L address where data was written last if \$s721 indicates [1: Error] at power-up	
\$s723		
\$s724	Writing result of \$LD address where data was written last 0: Normal 1: Error	
\$s725	\$LD address where data was written last if \$s724 indicates [1: Error] at power-up	
\$s726		

## Formatting SRAM

When settings are configured in the [SRAM/Clock Setting] window, always format SRAM in Local mode on the V9 series unit before use.

If SRAM is not formatted, the message "Data has some error. Error: 161 (or 163)" will appear and the screen program will not run.

- SRAM auto format  
For example, if the data storage destination or number of words for storage of history data changes in accordance with the logging and alarm functions, the sizes displayed in the [SRAM/Clock Setting] window may also change. In such a case, SRAM needs formatting every time the size changes.  
This formatting can be performed automatically. When the [SRAM Auto Format] checkbox is selected, SRAM will automatically be formatted each time a screen program is transferred. For details, refer to the following table.

When the [SRAM Auto Format] checkbox is selected

SRAM Area	Condition	Auto Format
Storage Area for Memo Pad	Size increases	No
	Size decreases	Yes
Non-volatile Device (Word) (\$L) Non-volatile Device (Double-word) (\$LD)	Size increases	Only the increased device memory area is formatted while the existing area is not formatted.
	Size decreases	Only the decreased device memory area is deleted while the existing area is not formatted.
Japanese Conversion Function	-	No
Logging server	Changes to server settings, such as number of saves	Yes (all history data is cleared)
Alarm Server	Changes to server settings, such as number of saves	Yes (all history data is cleared)
Operation log	Changes to settings, such as number of saves	Yes

## Backlight

Configure how the backlight is controlled by the V9 series unit.

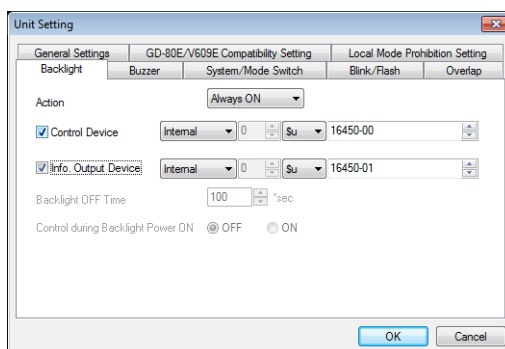

Item	Description
Action	Always ON
	The backlight is always on.
Auto 1	<p>Backlight OFF conditions: The backlight is turned off when the time specified by [Backlight OFF Time] has elapsed from the instant when all the following conditions are met. <sup>*1</sup></p> <ul style="list-style-type: none"> <li>Control device memory: OFF</li> <li>Screen display (lamp, data display, calendar, etc.): No change</li> <li>Touch switch: OFF</li> </ul> <p>Backlight ON conditions: The backlight is turned on when any of the following conditions is met. <sup>*2</sup></p> <ul style="list-style-type: none"> <li>Control device memory: ON (always ON)</li> <li>Screen display: Changed</li> <li>Somewhere on the screen is touched.</li> <li>Normal/call-overlap: ON/OFF_</li> <li>Multi-/global overlap: ON/OFF, overlap number changed</li> </ul>
Auto 2	<p>Backlight OFF conditions: The backlight is turned off when the time specified by [Backlight OFF Time] has elapsed from the instant when all the following conditions are met. <sup>*1</sup></p> <ul style="list-style-type: none"> <li>Control device memory: OFF</li> <li>Touch switch: OFF</li> </ul> <p>Backlight ON conditions: The backlight is turned on when any of the following conditions is met. <sup>*2</sup></p> <ul style="list-style-type: none"> <li>Control device memory: ON (always ON)</li> <li>Somewhere on the screen is touched.</li> </ul>
Auto 3	<p>Backlight OFF conditions: The backlight is turned off when the time specified by [Backlight OFF Time] has elapsed from the instant when all the following conditions are met. <sup>*1</sup></p> <ul style="list-style-type: none"> <li>Control device memory: OFF</li> <li>Touch switch: OFF</li> </ul> <p>Backlight ON conditions: The backlight is turned on when any of the following conditions is met. <sup>*2</sup></p> <ul style="list-style-type: none"> <li>Control device memory: ON (always ON)</li> <li>Screen changeover</li> <li>Somewhere on the screen is touched.</li> <li>Normal/call-overlap: ON/OFF</li> <li>Multi-/global overlap: ON/OFF, overlap number changed</li> </ul>
Manual	<p>Backlight OFF conditions: The backlight is turned off when either of the following operations is performed.</p> <ul style="list-style-type: none"> <li>Press [SYSTEM] → [F5] on MONITOUCH. <sup>*3</sup></li> <li>Control device memory: OFF (bit changes from 1 to 0)</li> </ul> <p>Backlight ON conditions: The backlight is turned on when any of the following conditions is met. <sup>*2</sup></p> <ul style="list-style-type: none"> <li>Somewhere on the screen is touched.</li> <li>A function switch is pressed. <sup>*3</sup></li> <li>Control device memory: ON (bit changes from 0 to 1)</li> </ul>
Control Device	<p>This setting is available when an option other than [Always ON] is set. This device memory controls the backlight.</p> <p>0: Backlight turned off when conditions are met 1: Backlight turned on</p>
Info. Output Device	<p>Stores the ON/OFF state of the backlight.</p> <p>0: Backlight turned off 1: Backlight turned on</p> <p>* This bit is 1 when the backlight is turned on even if the control device memory is OFF.</p>

Item	Description
Backlight OFF Time	0~65535 (sec) This setting is only available when [Auto 1], [Auto 2] or [Auto 3] is selected for [Action]. Set the length of time that elapses before the backlight is turned off after the OFF conditions have been met.
Control during Backlight Power ON	This setting is only available when [Manual] is selected for [Action]. Select the backlight ON/OFF status for when the power is turned on and when the mode changes from STOP to RUN.

- \*1 When the entire screen display is refreshed, such as when changing over the entire screen or turning on/off or switching an overlap display, the time measured for [Backlight OFF Time] is cleared.
- \*2 No switch data is output if a switch is pressed with the backlight off. When a switch is pressed with the backlight off, the backlight is turned on. Switch data is output from switch operations made after 500 ms has elapsed since the backlight was turned on.
- \*3 Disabled when the control device memory is ON.

## Buzzer

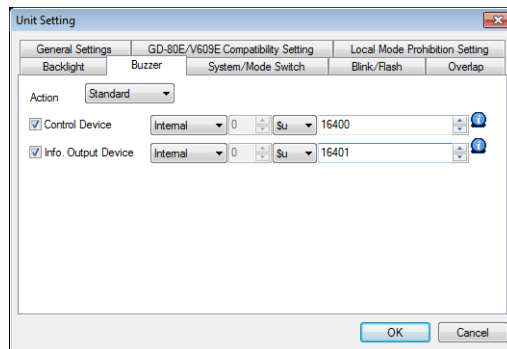

Item	Description																																															
Action	Set the buzzer sound that is output when a switch is pressed. <ul style="list-style-type: none"> <li>• Standard: 100 msec</li> <li>• Short: 10 msec</li> <li>• Continuous: Continuous</li> <li>• OFF: No buzzer sounding</li> </ul>																																															
Control Device	Sound the buzzer using an external command. <table border="1" style="margin: 10px auto;"> <thead> <tr> <th colspan="11">MSB</th> <th colspan="4">LSB</th> </tr> <tr> <th>15</th><th>14</th><th>13</th><th>12</th><th>11</th><th>10</th><th>09</th><th>08</th><th>07</th><th>06</th><th>05</th><th>04</th><th>03</th><th>02</th><th>01</th><th>00</th> </tr> </thead> <tbody> <tr> <td>0</td><td>0</td><td>0</td><td>0</td><td>0</td><td>0</td><td>0</td><td>0</td><td>0</td><td>0</td><td>0</td><td>0</td><td>0</td><td></td><td></td><td></td> </tr> </tbody> </table> <p style="text-align: center;">Not used (always set to "0")</p> <p style="text-align: right;">                     Continuous buzzer *                      1: Execute                      Error buzzer                      0 → 1: Execute                      Single shot buzzer                      0 → 1: Execute                 </p> <p>* The [Use Continuous Buzzer Sound] checkbox must be selected at [Unit Setting] → [General Settings]. For details, refer to <a href="#">page 1-10</a>.</p>	MSB											LSB				15	14	13	12	11	10	09	08	07	06	05	04	03	02	01	00	0	0	0	0	0	0	0	0	0	0	0	0	0			
MSB											LSB																																					
15	14	13	12	11	10	09	08	07	06	05	04	03	02	01	00																																	
0	0	0	0	0	0	0	0	0	0	0	0	0																																				
Info. Output Device	This device memory stores the state of the control device memory. <table border="1" style="margin: 10px auto;"> <thead> <tr> <th colspan="11">MSB</th> <th colspan="4">LSB</th> </tr> <tr> <th>15</th><th>14</th><th>13</th><th>12</th><th>11</th><th>10</th><th>09</th><th>08</th><th>07</th><th>06</th><th>05</th><th>04</th><th>03</th><th>02</th><th>01</th><th>00</th> </tr> </thead> <tbody> <tr> <td>0</td><td>0</td><td>0</td><td>0</td><td>0</td><td>0</td><td>0</td><td>0</td><td>0</td><td>0</td><td>0</td><td>0</td><td>0</td><td></td><td></td><td></td> </tr> </tbody> </table> <p style="text-align: center;">Not used (always set to "0")</p> <p style="text-align: right;">                     Continuous buzzer                      Error buzzer                      Single shot buzzer                 </p>	MSB											LSB				15	14	13	12	11	10	09	08	07	06	05	04	03	02	01	00	0	0	0	0	0	0	0	0	0	0	0	0	0			
MSB											LSB																																					
15	14	13	12	11	10	09	08	07	06	05	04	03	02	01	00																																	
0	0	0	0	0	0	0	0	0	0	0	0	0																																				

## System/Mode Switch

These settings relate to the operation of the [SYSTEM] switch and [MODE] (F1) switch in RUN mode.

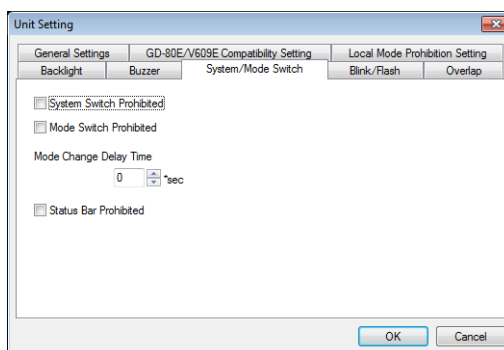

Item	Description
System Switch Prohibited	Prohibit the display of the system menu. The system menu is not displayed even if the [SYSTEM] switch is pressed. The status bar is not displayed either. For details on switching to Local mode, refer to <a href="#">page 1-9</a> .
Mode Switch Prohibited	Prohibit the display of the [Local] switch on the system menu (for switching to Local mode). Other switches on the system menu remain available. For details on switching to Local mode, refer to <a href="#">page 1-9</a> .
Mode Change Delay Time	0 - 30 (sec) Set the mode change delay time for switching from RUN mode to Local mode. For details, refer to <a href="#">page 1-9</a> . * The same delay time is applied when disabling [System Switch Prohibited] and [Mode Switch Prohibited].
Status Bar Prohibited	Prohibit the display of the status bar at the bottom right of the screen.

## Switching from RUN mode to Local mode

The procedure varies depending on the setting for [System Switch Prohibited] and [Mode Switch Prohibited].

Mode Change Delay Time: t (0 to 30 seconds)

Settings	Method
Not prohibited	Press [SYSTEM] to display the system menu and hold down the [Local] switch for "t" seconds.
System Switch Prohibited	Hold down [SYSTEM] and [F7] together for "t" seconds.
Mode Switch Prohibited	Press [SYSTEM] to display the system menu and hold down [F1] and [F7] together for "t" seconds.

## Blink/Flash

The blink/flash time for the blink color can be set.

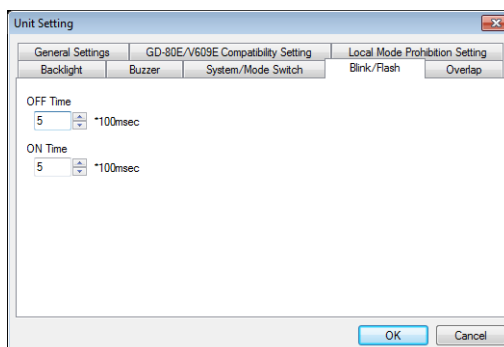

Item	Description
OFF Time (× 100 msec)	0: Blinking at about 500 msec intervals 1 to 100: Blinking at about × 100 msec intervals
ON Time (× 100 msec)	

## General Settings

These options are classified into two groups: settings compatible with older models, and other additional settings. Settings compatible with older models are set automatically when converting screen programs to the V9 series.

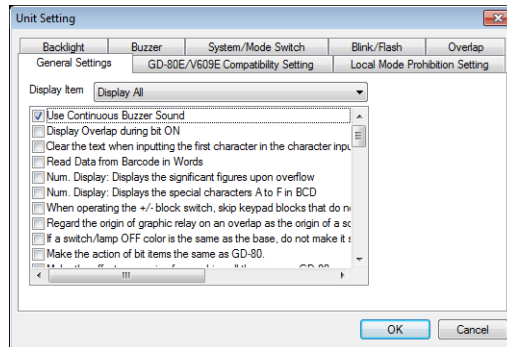

Item	Description																							
Use Continuous Buzzer Sound	Used to set whether or not to use a continuous buzzer. <ul style="list-style-type: none"> <li>• Unselected Do not use a continuous buzzer.</li> <li>• Selected The buzzer sounds continuously while the control device memory of the buzzer is ON. For details, refer to <a href="#">page 1-8</a>.</li> </ul>																							
Display Overlap during bit ON	Used to set the operation of normal/call-overlaps (when using control device memory). <ul style="list-style-type: none"> <li>• Unselected Recognized at the edge. Even if the bit is ON when a screen is opened, the overlap is not displayed.</li> <li>• Selected Recognized at the level. The overlap is displayed while the bit is ON.</li> </ul>																							
Clear the text when inputting the first character in the character input mode	Used to set the operation performed when a character key is first pressed in the character input mode. <ul style="list-style-type: none"> <li>• Unselected Existing text remains in the entry display part.</li> <li>• Selected Existing text in the entry display part is automatically cleared.</li> </ul>																							
Read Data from Barcode in Words	Used to set the unit of counting read data to be output to the I/F device memory for barcode setting. <ul style="list-style-type: none"> <li>• Unselected Unit: bytes</li> <li>• Selected Unit: words (same as GD-80)</li> </ul>																							
Num. Display: Displays the significant figures upon overflow	Used to set the display on MONITOUCH when an overflow occurs on a numerical display part. <p>Example: When D100 = 1234</p> <ul style="list-style-type: none"> <li>• Unselected 4-digit display: "1234" 2-digit display "--"</li> <li>• Selected 4-digit display: "1234" 2-digit display "34"</li> </ul>																							
Num. Display: Displays the special characters A to F in BCD	Used to set the display on MONITOUCH when BCD is selected for a numerical display part. <table border="1" style="margin-left: auto; margin-right: auto;"> <thead> <tr> <th rowspan="2">PLC</th> <th colspan="2">Display on MONITOUCH</th> </tr> <tr> <th>Unselected</th> <th>Selected</th> </tr> </thead> <tbody> <tr> <td>0~9</td> <td>0~9</td> <td>0~9</td> </tr> <tr> <td>A</td> <td>0</td> <td>.</td> </tr> <tr> <td>B</td> <td>0</td> <td>:</td> </tr> <tr> <td>C</td> <td>0</td> <td>—</td> </tr> <tr> <td>D</td> <td>0</td> <td>+</td> </tr> <tr> <td>E,F</td> <td>0</td> <td>(Space)</td> </tr> </tbody> </table>	PLC	Display on MONITOUCH		Unselected	Selected	0~9	0~9	0~9	A	0	.	B	0	:	C	0	—	D	0	+	E,F	0	(Space)
PLC	Display on MONITOUCH																							
	Unselected	Selected																						
0~9	0~9	0~9																						
A	0	.																						
B	0	:																						
C	0	—																						
D	0	+																						
E,F	0	(Space)																						

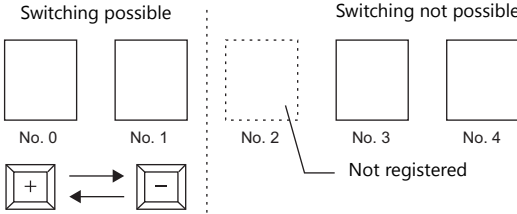
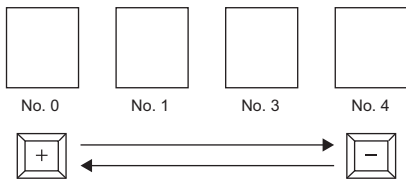
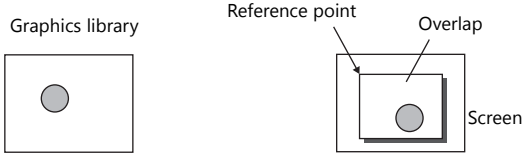
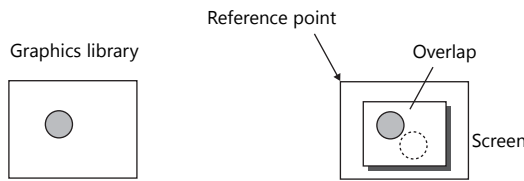
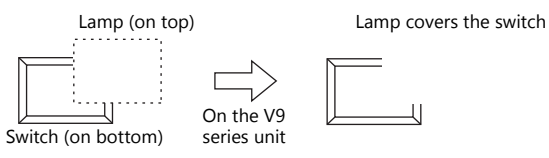
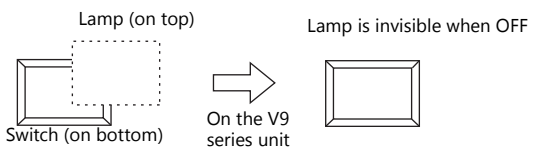
Item	Description
<p>When operating the +/-block switch, skip keypad blocks that do not exist</p>	<p>Used to set the operation performed if there is an unregistered block between the block numbers [Min. Block] and [Max. Block] for the target of switching the keypad block.</p> <ul style="list-style-type: none"> <li> <b>Unselected</b>                      Switching is stopped when an unregistered block is encountered.                      </li> <li> <b>Selected</b>                      Switching is performed while skipping unregistered blocks.                      </li> </ul>
<p>Regard the origin of graphic relay on an overlap as the origin of a screen</p>	<p>Used to set the reference position when the graphic relay function is set for an overlap.</p> <ul style="list-style-type: none"> <li> <b>Unselected</b>                      Graphics are placed with respect to the origin of the overlap display part.                      </li> <li> <b>Selected</b>                      Graphics are placed with respect to the origin of the screen.                      </li> </ul>
<p>If a switch/lamp OFF color is the same as the base, do not make it solid filled</p>	<p>Used to set the OFF color display when the screen background color is the same as the OFF color of a switch or lamp.</p> <ul style="list-style-type: none"> <li> <b>Unselected</b>                      The switch or lamp part placed on top covers the part that is underneath it on both the editor and MONITOUCH.                      </li> <li> <b>Selected</b>                      The part on top covers the part underneath it on the editor. On MONITOUCH, the OFF color becomes transparent.                      </li> </ul>
<p>Make the action of bit items the same as GD-80.</p>	<p>Select this checkbox when the Hitachi HIDIC-S10 is connected and a screen program created for the GD-80 or V4 series converted for use on a V9 series unit. If this checkbox is not selected, compatibility cannot be retained because bit weights are inverted from the GD-80 and V4 processing when they are converted for use on a V9 series unit.</p>



Item	Description																																								
<p>Make the offset processing for graphic call the same as GD-80</p>	<p>If two or three conditions shown below are present, the graphic display position at bit ON is different from that on the GD-80. To make it the same as the GD-80, select this checkbox.</p> <ul style="list-style-type: none"> <li>Graphic relay used</li> <li>Graphic call used</li> <li>Graphic call with offset and parameter settings</li> </ul>																																								
<p>Use Vertical Text</p>	<p>If you want to place Japanese characters, select this checkbox.</p>																																								
<p>Use Internal Flash ROM as Back-up Area</p>	<p>Select this checkbox to use part of the FROM area on MONITOUCH as a device memory backup area (PLC and internal). This function cannot be used with the station number table.</p> <p>Station number table Station numbers of target devices can be set as desired for PLC communication or temperature control network communication using the following devices.</p> <ul style="list-style-type: none"> <li>PLC: Mitsubishi QnA series (Ethernet), 1:n connection only</li> <li>PLC: Mitsubishi QnH (Q) series (Ethernet), 1:n connection only</li> <li>PLC: OMRON SYSMAC CS1/CJ1 (Ethernet Auto), 1:n connection only</li> <li>PLC: OMRON SYSMAC CS1/CJ1 DNA (Ethernet Auto), 1:n connection only</li> <li>Temperature controller: Fuji Electric F-MPC04P (loader)</li> <li>Temperature controller: Fuji Electric F-MPC04S (UM03)</li> </ul>																																								
<p>Print Alarm Logging Data (V8 compatible) in the Displayed Format</p>	<p>Used to make print settings for alarm logging.</p> <ul style="list-style-type: none"> <li>Unselected Both bit ON data and bit OFF data are printed.</li> <li>Selected Data is printed in the currently displayed format (if bit ON data is shown, only bit ON data is printed).</li> </ul>																																								
<p>Validate the Character Order Setting for Text in JIS Codes</p>	<p>Used to set the display of JIS codes for character display parts.</p> <ul style="list-style-type: none"> <li>Unselected Displayed in MSB → LSB format regardless of the setting for [Text Process] ([Char. Display] → [Text Process]).</li> <li>Selected The setting for [Text Process] ([Char. Display] → [Text Process]) takes effect.</li> </ul>																																								
<p>Use 3-D Parts</p>	<p>If a screen program that uses 3D parts for a 128-color monitor has been converted into data for a 64k-color or 32k-color monitor, this checkbox is selected automatically. Use the setting as is.</p>																																								
<p>Hide Check Screen</p>	<p>Used to set the display on the monitor for the interval from when MONITOUCH is turned ON to when RUN mode starts.</p> <ul style="list-style-type: none"> <li>Unselected "Data Loading..." → splash screen → RUN mode</li> <li>Selected Black screen → splash screen → RUN mode</li> </ul>																																								
<p>Convert NULL to Space with the LD/RD Macro</p>	<p>Used to set how NULL data processing is performed when reading a CSV file that contains NULL data (attribute table type: CHAR).</p> <p>Applicable commands LD_RECIPE, LD_RECIPE2, LD_RECIPSEL, LD_RECIPSEL2, RD_RECIPE_FILE, RD_RECIPE_COLUMN, RD_RECIPE_LINE</p> <ul style="list-style-type: none"> <li>Unselected Loaded as NULL (00H)</li> <li>Selected Converted into space (20H) and loaded</li> </ul>																																								
<p>Permit Double-Word Transfer by BMOV</p>	<p>Used to set the action to be taken when the transfer source (transfer target) device is a double-word device.</p> <p>Example: Fuji Electric MICREX-F series BD (data device)</p> <ul style="list-style-type: none"> <li>Unselected: Only the lower-order word is transferred. \$u100 = BD100 C:4 (BMOV)</li> </ul> <table border="1" data-bbox="592 1659 1123 1794"> <tr> <td>\$u100</td> <td>1111H</td> <td>←</td> <td>BD100</td> <td>22221111H</td> </tr> <tr> <td>\$u101</td> <td>3333H</td> <td>←</td> <td>BD101</td> <td>44443333H</td> </tr> <tr> <td>\$u102</td> <td>5555H</td> <td>←</td> <td>BD102</td> <td>66665555H</td> </tr> <tr> <td>\$u103</td> <td>7777H</td> <td>←</td> <td>BD103</td> <td>88887777H</td> </tr> </table> <ul style="list-style-type: none"> <li>Selected: Both the upper- and lower-order words are transferred. \$u100 = BD100 C:4 (BMOV) (D)</li> </ul> <table border="1" data-bbox="592 1883 1123 2018"> <tr> <td>\$u100</td> <td>1111H</td> <td>←</td> <td>BD100</td> <td>22221111H</td> </tr> <tr> <td>\$u101</td> <td>2222H</td> <td></td> <td></td> <td></td> </tr> <tr> <td>\$u102</td> <td>3333H</td> <td>←</td> <td>BD101</td> <td>44443333H</td> </tr> <tr> <td>\$u103</td> <td>4444H</td> <td></td> <td></td> <td></td> </tr> </table>	\$u100	1111H	←	BD100	22221111H	\$u101	3333H	←	BD101	44443333H	\$u102	5555H	←	BD102	66665555H	\$u103	7777H	←	BD103	88887777H	\$u100	1111H	←	BD100	22221111H	\$u101	2222H				\$u102	3333H	←	BD101	44443333H	\$u103	4444H			
\$u100	1111H	←	BD100	22221111H																																					
\$u101	3333H	←	BD101	44443333H																																					
\$u102	5555H	←	BD102	66665555H																																					
\$u103	7777H	←	BD103	88887777H																																					
\$u100	1111H	←	BD100	22221111H																																					
\$u101	2222H																																								
\$u102	3333H	←	BD101	44443333H																																					
\$u103	4444H																																								

Item	Description																																					
Compatible when the video input signal is only in the odd or even field	<p>Used to set the video input signal.</p> <ul style="list-style-type: none"> <li>Unselected Both odd- and even-numbered fields</li> <li>Selected Either the odd- or even-numbered fields</li> </ul>																																					
Set the Height of the Windows Font to Gothic	<p>Used to set the font size to be applied when the screen program created using Windows fonts on V-SFT version 2.1.3.0 or earlier is opened on V-SFT version 2.1.4.0 and later.</p> <ul style="list-style-type: none"> <li>Unselected Created with version 2.1.3.0 or earlier → Opened with version 2.1.4.0 or later</li> </ul>  <ul style="list-style-type: none"> <li>Selected Retains compatibility with screen programs created with version 2.1.3.0 or earlier.</li> </ul>																																					
Decimal Point Compatible in Reading Recipe File	<p>Used to set the action to take when a CSV file contains values without a decimal point even though "with decimal point" is set on the attribute table.</p> <p>Example: Attribute table Type: DEC, decimal point: 1, word count: 1</p> <p>CSV file</p> <table border="1" data-bbox="842 826 1299 860"> <tr> <td>123.4</td> <td>12.34</td> <td>0.123</td> <td>1234</td> <td>12340</td> </tr> </table> <ul style="list-style-type: none"> <li>Unselected: Data is read assuming that the decimal point is specified</li> </ul> <table border="1" data-bbox="842 927 1299 1032"> <tr> <td>D100</td> <td>D101</td> <td>D102</td> <td>D103</td> <td>D104</td> </tr> <tr> <td>1234</td> <td>123</td> <td>1</td> <td>12340</td> <td>57864</td> </tr> <tr> <td>MONITOUCH display</td> <td>123.4</td> <td>12.3</td> <td>0.1</td> <td>1234.0</td> <td>5786.4</td> </tr> </table> <p style="text-align: right;">Overflow ↗</p> <ul style="list-style-type: none"> <li>Selected: Data is read without assuming that the decimal point is specified</li> </ul> <table border="1" data-bbox="842 1155 1299 1261"> <tr> <td>D100</td> <td>D101</td> <td>D102</td> <td>D103</td> <td>D104</td> </tr> <tr> <td>1234</td> <td>123</td> <td>1</td> <td>1234</td> <td>12340</td> </tr> <tr> <td>MONITOUCH display</td> <td>123.4</td> <td>12.3</td> <td>0.1</td> <td>123.4</td> <td>1234.0</td> </tr> </table>	123.4	12.34	0.123	1234	12340	D100	D101	D102	D103	D104	1234	123	1	12340	57864	MONITOUCH display	123.4	12.3	0.1	1234.0	5786.4	D100	D101	D102	D103	D104	1234	123	1	1234	12340	MONITOUCH display	123.4	12.3	0.1	123.4	1234.0
123.4	12.34	0.123	1234	12340																																		
D100	D101	D102	D103	D104																																		
1234	123	1	12340	57864																																		
MONITOUCH display	123.4	12.3	0.1	1234.0	5786.4																																	
D100	D101	D102	D103	D104																																		
1234	123	1	1234	12340																																		
MONITOUCH display	123.4	12.3	0.1	123.4	1234.0																																	
Fix the Width of the Windows Font	<p>Used when numerical data display or character display parts are created using Windows fonts on Windows XP/Vista/7/8.</p> <ul style="list-style-type: none"> <li>Unselected Depending on the OS, text width may change on MONITOUCH.</li> <li>Selected Regardless of the OS, text width is standardized on MONITOUCH.</li> </ul>																																					
Delete folders from the oldest if Storage is lacking in space for backup	<p>Used to set the operation that is performed when the storage device capacity is not sufficient for creating a backup file of logging servers/alarm servers.</p> <ul style="list-style-type: none"> <li>Unselected A backup file is not created.</li> <li>Selected <ul style="list-style-type: none"> <li>If a folder for the previous day or earlier exists, the folder with the oldest date is retrieved and deleted entirely.</li> <li>If only the folder for the current day exists, only the file with the oldest date in the history of the specified logging server or alarm server is retrieved and deleted.</li> </ul> </li> </ul>																																					
Do Not Delete the Alarm Now Occurring	<p>Used to set the action to take when the [DEL] key on an alarm display is pressed.</p> <ul style="list-style-type: none"> <li>Unselected All the alarms being displayed can be deleted using the [DEL] key.</li> <li>Selected The alarms currently occurring cannot be deleted using the [DEL] key.</li> </ul>																																					
Adjust the position of Windows Font Multi Text	<p>Used for position correction when using a Windows Font in multi-text.</p> <ul style="list-style-type: none"> <li>Unselected Process character height of multi-text as a fixed value.</li> <li>Selected (default): Correct the character height of multi-text so it fits within the specified area.</li> </ul>																																					

Item	Description
Follow to the PLC1 setting for the text process in a recipe file.	Used to determine how to recognize LSB and MSB when processing text strings in recipe files. <ul style="list-style-type: none"> <li>• Unselected: Depends on the attribute setting</li> <li>• Selected: Depends on the [Text Process] setting of PLC1</li> </ul>
SW Word Operation (Transfer) Code Conversion	When a switch with [Word Operation] set for [Function] is operated under the following conditions, the action performed depends on this setting. Condition 1: [Hardware Setting] → [PLC Properties] → [BCD] for [Code] Condition 2: [Word Operation] for switch [Function] → [→ (Transfer)] for [Operation Mode] Condition 3: [Constant (DEC/DEC-)] for [Operation Memory] Condition 4: [PLC Device] for [Operand Device] <ul style="list-style-type: none"> <li>• Unselected The constant (DEC/DEC-) specified in the operation device memory is stored as DEC/DEC- data in the PLC.</li> <li>• Selected The constant (DEC/DEC-) specified in the operation device memory is converted into BCD and stored in the PLC.</li> </ul>
Avoid the use of upper three bits in the Read Area (n + 2) (V8 compatible)	This option determines how the three high-order bits in the read area "n + 2" (screen number designation) are treated following specification changes relevant to screen number extension. <ul style="list-style-type: none"> <li>• Unselected: The three high-order bits are used for screen number designation.</li> <li>• Selected: The three high-order bits are system reserved (0). Screen number designation range <ul style="list-style-type: none"> <li>- DEC: 0 to 4095</li> <li>- BCD: 0 to 1999 (values "2000" and after invalid)</li> </ul> </li> </ul>
File name designation in Recipe Macro (V7 compatible)	This option determines the number of characters used to specify a recipe macro file name. <ul style="list-style-type: none"> <li>• Unselected: 8 characters</li> <li>• Selected: 10 characters (as with the case of V7) → automatically selected during V9 conversion</li> </ul> Applicable commands SET_RECIPEFOLDER, RD_RECIPE_FILE, RD_RECIPE_LINE, RD_RECIPE_COLUMN, WR_RECIPE_FILE, WR_RECIPE_LINE, WR_RECIPE_COLUMN, GET_RECIPE_FILEINFO
Save the pitch setting of the texts of Switch/Lamp	Used to set [Char. Prop.] → [Set line spacing] in the switch and lamp settings window. <ul style="list-style-type: none"> <li>• Unselected The value specified for line spacing is cleared at the end of screen program editing. The setting is unselected for the next editing.</li> <li>• Selected The value specified for line spacing is saved in the screen program. The setting is selected and the value is also displayed for the next editing.</li> </ul>
Maintain the letter alignment of a switch/lamp	Used to set the text alignment in the switch and lamp settings window. <ul style="list-style-type: none"> <li>• Unselected The text alignment setting is cleared at the end of screen program editing. The alignment setting for every switch and lamp is cleared for the next editing.</li> <li>• Selected The text alignment setting is saved in the screen program. The setting is retained for the next editing.</li> </ul>
Allow to use Insert/DELETE keys when entering values	This option is relevant to using the [←] and [→] keys for data insertion and using the [DELETE] and [BS] keys for deletion. For details, refer to "6.1 Numerical Data Entry" "Style" page 6-11.
Format the SRAM forcefully	This option determines the action taken when "error: 161 (0:)" occurs, which indicates an SRAM formatting error, no SRAM data immediately after shipment, or loss of SRAM data due to battery disconnection. <ul style="list-style-type: none"> <li>• Unselected (default): Formatting the SRAM is executed in Local mode while the battery is connected to the V9 series unit.</li> <li>• Selected A forced formatting is executed. Whether automatic formatting was executed can be checked at \$s1085. (After execution, "1" is stored at \$s1085. Switching MONITOUCH to Local mode again clears the value to "0".)</li> </ul>
Retain compatibility with negative value handling of CVFD macro command	Used to set the action to taken when converting negative values. <ul style="list-style-type: none"> <li>• Unselected (default): An action according to the value at \$s99 is taken.</li> <li>• Selected: A truncation is performed irrespective of the value at \$s99.</li> </ul> * For details on the "CVFD" macro command and address \$s99, refer to the V9 Series Macro Reference Manual.

Item	Description
Backup the recipe file	<p>Used to set the action taken when an error occurs in writing to a CSV file in recipe mode.</p> <ul style="list-style-type: none"> <li>• Unselected (default): No backup file is created.</li> <li>• Selected <ul style="list-style-type: none"> <li>- Normally ended: A CSV file and backup file "xxx.BAK" are created.</li> <li>- Abnormally ended: A temporary file from "xxx.000" to "xxx.999"* is created.</li> </ul> </li> </ul> <p>* If temporary files "xxx.000" through "xxx.999" already exist, the oldest file is retrieved and deleted.</p>
Display the recipe mode after executing SV/WR macro commands	<p>Used to set whether or not to update the data in recipe mode when the RECIPE folder on the storage device is reread at the time of execution of the macro commands given below.</p> <ul style="list-style-type: none"> <li>• Unselected (default): The recipe mode item is not updated.</li> <li>• Selected The recipe mode item is updated. The recipe mode item is reset to the default status. If editing is disabled by the command device memory, the current display status is kept.</li> </ul> <p>Applicable commands SV_RECIPE, SV_RECIPE2, SV_RECIPSEL, SV_RECIPSEL2, WR_RECIPE_FILE, WR_RECIPE_LINE, WR_RECIPE_COLUMN</p>
Return switch prohibited when switching the screen by an external command	<p>Used to set the action taken when a switch with [Return] set for [Function] is used.</p> <ul style="list-style-type: none"> <li>• Unselected (default): It is possible to go back to the previously displayed screen even if it was switched by an external command.</li> <li>• Selected It is not possible to go back to the previously displayed screen if it was switched by an external command.</li> </ul>
Cancel the restriction on the number of registerable characters for Switch and Lamp (127 characters)	<p>Used to set the number of characters that can be displayed on a switch or lamp.</p> <ul style="list-style-type: none"> <li>• Unselected (default): The number of registerable characters is limited according to the width of the item.</li> <li>• Selected A maximum of 127 characters can be registered regardless of the width of the item.</li> </ul> <p>* When the [Char. Prop.] → [Auto-adjust the size according to the style] checkbox is selected in the switch/lamp settings window, the settings of [Auto-adjust the size according to the style] take precedence.</p>
Scale the upper/lower limit of the alarm for num. display	<p>Used to set the range of values associated with issuing alarms for numerical data display.</p> <p>Example: Numerical data display to be colored blue for a value 101 or above</p> <pre>Numerical data display device memory : D100 Alarm maximum value device memory   : \$u1000, Alarm color: Blue Before range change                  : 0 - 1000 After range change                   : 0 to 100 (101 or above: Normal color → Blue)</pre> <ul style="list-style-type: none"> <li>• Unselected (default): The maximum and minimum values for alarms are set in the range according to "After range change." - Alarm maximum value: \$u1000 = 100</li> <li>• Selected The maximum and minimum values for alarm are set in the range according to "Before range change." (With constant designated, the operation in the case of "unselected" will take place.) - Alarm maximum value: \$u1000 = 1000</li> </ul>
Change the display from "00:00 AM/PM" to "12:00 AM/PM"	<p>Used to set the time display to the 12-hour format.</p> <p>Applicable parts Time Display</p> <ul style="list-style-type: none"> <li>• Unselected Midnight → Displayed as "00:00 AM" Noon → Displayed as "00:00 PM"</li> <li>• Selected (default): Midnight → Displayed as "12:00 AM" Noon → Displayed as "12:00 PM"</li> </ul>

Item	Description
Output operation of Write Area (V7 compatible)	<p>This option determines whether the switch action or the outputting to write area has priority immediately after the screen is switched over.</p> <ul style="list-style-type: none"> <li>• Unselected The switch action is performed prior to output to the write area.</li> <li>• Selected (default, V7 compatible operation) The switch action is performed after output to the write area is complete.</li> </ul> <p>* This setting is only available when the [System Setting] → [Unit Setting] → [General Setting] → [Use read/write area (V8 compatible)] checkbox is selected.</p>
Synchronize system cycle and drawing cycle (V8 compatible)	<p>Used to set the processing method of MONITOUCH.</p> <ul style="list-style-type: none"> <li>• Unselected (default): Perform the system cycle and drawing cycle asynchronously. For details, refer to <a href="#">"1.2 Process Cycle" page 1-27</a>.</li> <li>• Selected Operate using V8 specifications.</li> </ul>
Inhibit simultaneous execution of multiple macros (V8 compatible)	<p>Used to set the action taken when execution of multiple macros occur at the same time.</p> <ul style="list-style-type: none"> <li>• Unselected (default): Process macros simultaneously.</li> <li>• Selected (V8 compatible operation): Finish execution of the current macro before executing the next macro.</li> </ul>
Retain the previous picture in graphic mode (V8 compatible)	<p>Used to set the drawing method when using graphic mode.</p> <ul style="list-style-type: none"> <li>• Unselected (default): Do not retain the image from the last drawing.</li> <li>• Selected (V8 compatible operation): Retain the image from the last drawing.</li> </ul>
Make the Entry mode operation command the same as V8	<p>Used to allocate [Control Device] and [Info. Output Device] in entry mode (when using a keypad).</p> <ul style="list-style-type: none"> <li>• Unselected (default): Operate using V9 specifications. For details, refer to <a href="#">"6 Entry"</a>.</li> <li>• Selected Operate using V8 specifications.</li> </ul>
Inhibit automatic optimization of memory reading operation (V8 compatible)	<p>Used to set the action taken when the V9 series unit reads a PLC device memory.</p> <ul style="list-style-type: none"> <li>• Unselected (default): Optimize reading in accordance with screen registration.</li> <li>• Selected Operate using V8 specifications.</li> </ul>
Invalidate cache for device writing operation (V8 compatible)	<p>Used to set V9 series processing of keypad entry.</p> <ul style="list-style-type: none"> <li>• Unselected (default): Write to the V9 series unit internally first and then update the display.</li> <li>• Selected Operate using V8 specifications.</li> </ul>
Allow max. 8 characters for naming files used in V8 recipe mode (V8 compatible)	<p>Used to set the maximum number of characters available for recipe filenames.</p> <ul style="list-style-type: none"> <li>• Unselected (default):                   Maximum of 64 characters</li> <li>• Selected (V8 compatible operation):   Maximum of 8 characters</li> </ul>
Use read/write area (V8 compatible)	<p>Used to set the action taken when changing to the V9 series from V6, V7, and V8 series units.</p> <ul style="list-style-type: none"> <li>• Unselected (default): Use [System Setting] → [Hardware Setting] → [Control Area].</li> <li>• Selected Operate using V8 specifications. Use [System Setting] → [Hardware Setting] → [Control Area].</li> </ul>
Gray out interlocked switches	<p>Used for display settings of a switch with an interlock set.</p> <ul style="list-style-type: none"> <li>• Unselected (default): The switch is displayed using the colors specified in the screen program.</li> <li>• Selected The switch is displayed grayed-out during interlock activation.</li> </ul>

Item	Description
Retain compatibility of logging server's SRAM storage	<p>Used to set the processing method of MONITOUCH when saving logging history data to SRAM.</p> <ul style="list-style-type: none"> <li>• Unselected (default) Processing is performed according to V8 specifications to reduce the amount of SRAM used.</li> <li>• Selected Processing is performed according to V9 specifications. (This setting is automatically selected when creating a new screen program or when converting a V8 screen program to a V9 screen program in the editor of versions 6.0.0.0 to 6.0.10.0.)</li> </ul> <p>* If this setting is changed, the SRAM will require reformatting because the amount of SRAM to be used will change.</p>
Output logging data in binary format	<p>Used to set the processing method of MONITOUCH when saving logging history data to a storage device.</p> <ul style="list-style-type: none"> <li>• Unselected Processing is performed according to V9 specifications. (This setting is automatically selected when creating a new screen program or when converting a V8 screen program to a V9 screen program in the editor of versions 6.0.0.0 to 6.0.10.0.)</li> <li>• Selected (default) Processing is performed according to V8 specifications to increase the speed of writing to the storage device.</li> </ul>
Retain compatibility of alarm server's SRAM storage	<p>Used to set the processing method of MONITOUCH when saving alarm history data to SRAM.</p> <ul style="list-style-type: none"> <li>• Unselected (default) Processing is performed according to V8 specifications to reduce the amount of SRAM used.</li> <li>• Selected Processing is performed according to V9 specifications. (This setting is automatically selected when creating a new screen program or when converting a V8 screen program to a V9 screen program in the editor of versions 6.0.0.0 to 6.0.11.0.)</li> </ul> <p>* If this setting is changed, the SRAM will require reformatting because the amount of SRAM to be used will change.</p>
Output alarm data in binary format	<p>Used to set the processing method of MONITOUCH when outputting alarm history data to a storage device.</p> <ul style="list-style-type: none"> <li>• Unselected Processing is performed according to V9 specifications. (This setting is automatically selected when creating a new screen program or when converting a V8 screen program to a V9 screen program in the editor of versions 6.0.0.0 to 6.0.11.0.)</li> <li>• Selected (default) Processing is performed according to V8 specifications to increase the speed of writing to the storage device.</li> </ul>
Text/multi text display position (V8 compatible)	<p>Used to set position correction for text and multi-text.</p> <ul style="list-style-type: none"> <li>• Unselected (default) Text/multi-text is placed at the specified coordinates.</li> <li>• Selected If using a bitmap font and "Shadow" is set in the text properties, text/multi-text is placed at a position shifted by one pixel upward to the left from the coordinates.</li> </ul>
Activate auto-scroll display of the alarm	<p>Used to set the operation that is performed when an alarm message is longer than the display area width.</p> <ul style="list-style-type: none"> <li>• Unselected The alarm message is displayed cut off and automatic scrolling is not performed.</li> <li>• Selected (default) When the message is selected with the cursor, automatic scrolling is performed to display the entire message.</li> </ul>
Use the point size specified in the message edit window for alarm parts using Windows fonts.	<p>Used to set the text size of alarm messages.</p> <ul style="list-style-type: none"> <li>• Unselected (default) Alarm messages are displayed using the size set at [Contents] → [Point] in the alarm settings window.</li> <li>• Selected Alarm messages are displayed using the size set at [Edit] (or right-click menu) → [Char. Prop.] → [Point] in the message editor.</li> </ul> <p>* This setting is only available when [Display Mode] → [Alarm History/Event History/Real Time] is selected in the alarm settings window.</p>
No code conversion when using the Device Memory Map (V8 compatible)	<p>Used to set the operation that is performed when "Word" or "Double Word" is set for "Data Type" in a device memory map.</p> <ul style="list-style-type: none"> <li>• Unselected (default) Data is transferred according to the setting of [System Setting] → [Hardware Setting] → [PLC1 to 8 Properties] → [Code].</li> <li>• Selected Data is transferred as is without code conversion.</li> </ul>

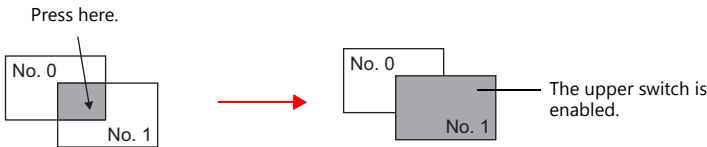
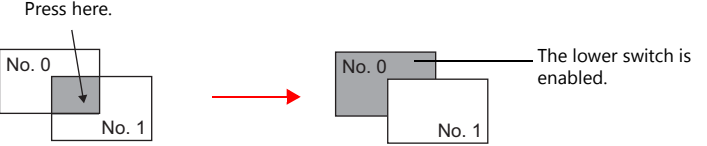
Item	Description
<p>Lower switch is valid when switches are overlapped (V8 compatible)</p>	<p>Used to set the operation that is performed when two switches overlap each other. *1</p> <p>Applicable parts Switch, Num. Display/Char. Display (with [Function] set to "Entry Target" and the [Display the keyboard] checkbox selected), Slider Switch, Memo Pad, Recipe, Alarm parts, and Trend parts</p> <p>Display on the editor Placement order: Switch No. 0, which was placed earlier is superimposed by switch No. 1 which was placed later.</p> <p>Operation on MONITOUCH</p> <ul style="list-style-type: none"> <li>Unselected (default) *2 The upper switch (No. 1) is enabled.</li> </ul>  <ul style="list-style-type: none"> <li>Selected *2 The lower switch (No. 0) is enabled.</li> </ul>  <p>*1 If any part that is not overlapping is pressed, the operation of the relevant switch is performed.</p> <p>*2 The default setting used after changing the model differs depending on the model and settings prior to the change.</p> <ul style="list-style-type: none"> <li>- Change from V4/GD-80 series to V9 series Default setting: unselected</li> <li>- Change from V8/V7/V6 series to V9 series Differs depending on whether the [System Setting] → [Unit Setting] → [General Setting] → [If a switch is overlaid on another, enable the upper switch] checkbox is selected for the screen program of the V8/V7/V6 series. (Before change) Default setting when checkbox is selected: Unselected (Before change) Default setting when checkbox is unselected: Selected</li> </ul>
<p>Shift subsequent record numbers of recipe data by one after a record is deleted.</p>	<p>Used to set the operation that is performed when deleting records from the recipe list settings window.</p> <p>* Only available when [Record-based transfer] is set for [Transfer Data].</p> <p>The operation that is performed differs depending on whether the transfer target setting at [System Setting] → [Recipe] → [File Format] is set as data only or the record name and data.</p> <ul style="list-style-type: none"> <li>Transfer target: Data <ul style="list-style-type: none"> <li>- Unselected (default) Record names remain because only data is deleted in the recipe file.</li> <li>- Selected Rows are shifted up because both record names and data are deleted in the recipe file.</li> </ul> </li> <li>Transfer target: Record name and data <ul style="list-style-type: none"> <li>- Unselected (default) Record names and data are deleted in the recipe file and empty rows remain.</li> <li>- Selected Rows are shifted up because both record names and data are deleted in the recipe file.</li> </ul> </li> </ul>

## Local Mode Prohibition Setting

This section explains how to prohibit configuration of settings in Local mode.

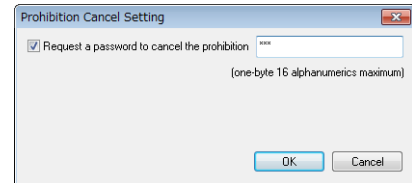
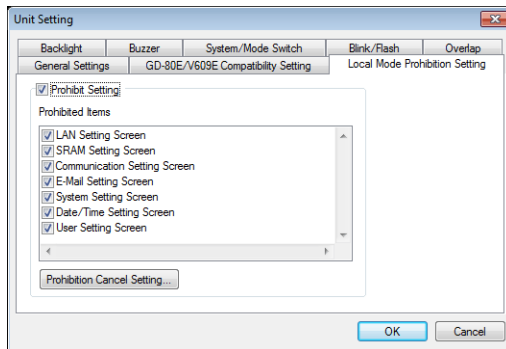

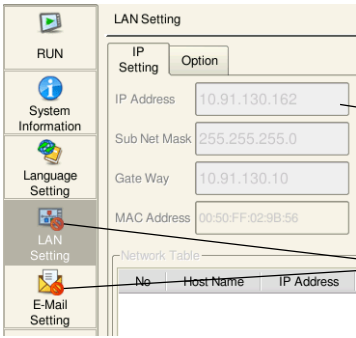
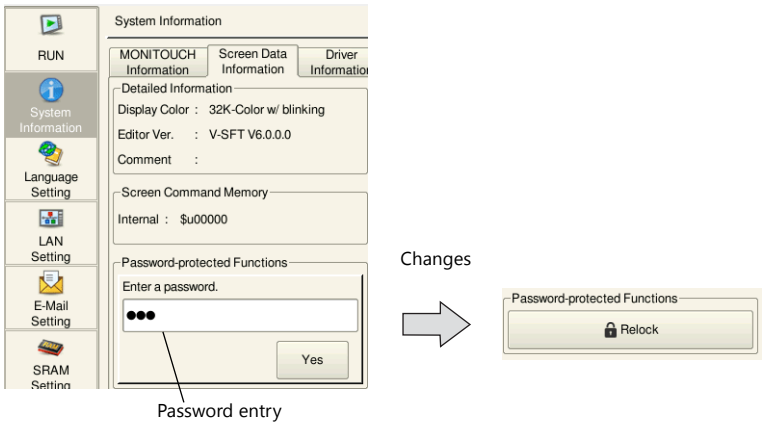
Item	Description
Prohibit Setting	Prohibit configuration of settings in Local mode.
Prohibited Items	<p>Select the screens to prohibit configuration in Local mode. A prohibited mark is displayed on the menu icon of the selected screens and the prohibited settings are grayed out.</p> <p>LAN Setting Screen (LAN/LAN2)                      SRAM Setting Screen                      Communication Setting Screen                      E-Mail Setting Screen                      System Setting Screen                      Date/Time Setting Screen                      User Setting Screen</p>  <p>Prohibited settings are grayed out</p> <p>Prohibited mark</p>
Prohibition Cancel Setting	<p>Set the password used to disable the prohibition setting for Local mode. Maximum of 16 one-byte alphanumeric characters</p> <p>The password is entered on the [System Information] → [Screen Data Information] screen in Local mode. Press [Relock] to validate the prohibition setting.</p>  <p>Password entry</p> <p>Changes</p>



After disabling the prohibition setting, the prohibition setting will be validated when the power is turned off and on again, or a screen program is transferred.



## GD-80E/V609E Compatibility Setting

This is a compatibility setting for when an EL-type MONITOUCH, such as the GD-80E or V609E (production discontinued), is to be replaced.

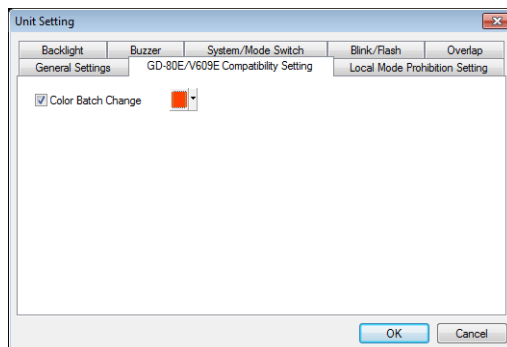

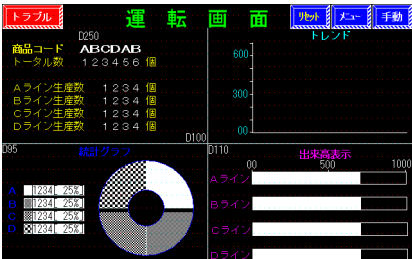
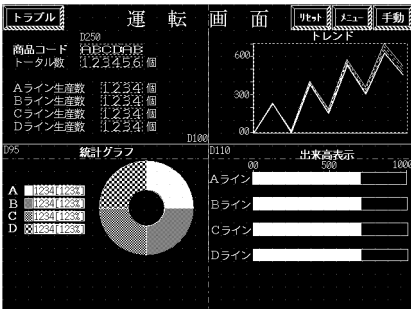
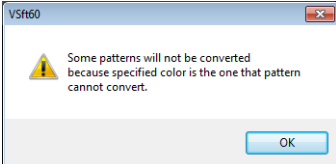
Item	Description
Color Batch Change	<p>Converts any colors other than black into the color specified here to make the display color the same as the one used on GD-80E/V609E (2 colors).</p> <div style="display: flex; justify-content: space-around;"> <div style="text-align: center;"> <p>GD-80E/V609E data displayed on computer</p>  </div> <div style="text-align: center;"> <p>V9080iC data displayed on computer</p>  </div> </div> <p>* The color data cannot be restored to the original after conversion. For pattern data, there are some colors that cannot be converted. In such a case, the following dialog box is displayed.</p> <div style="text-align: center;">  </div>

## 1.1.3 Communication Setting

This section explains the items in the [Hardware Setting] window.

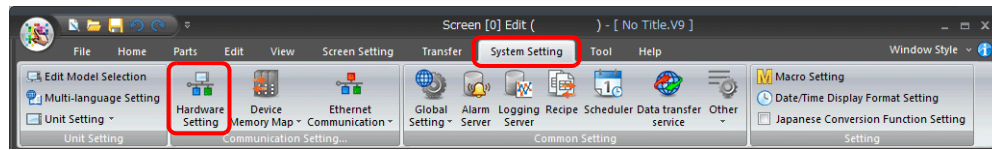

For information on other settings, refer to ["1.1.1 System Setting" page 1-1](#).

## Hardware Setting

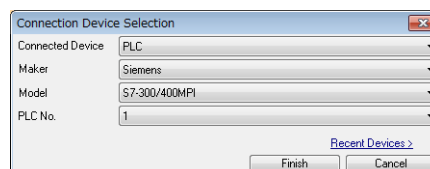
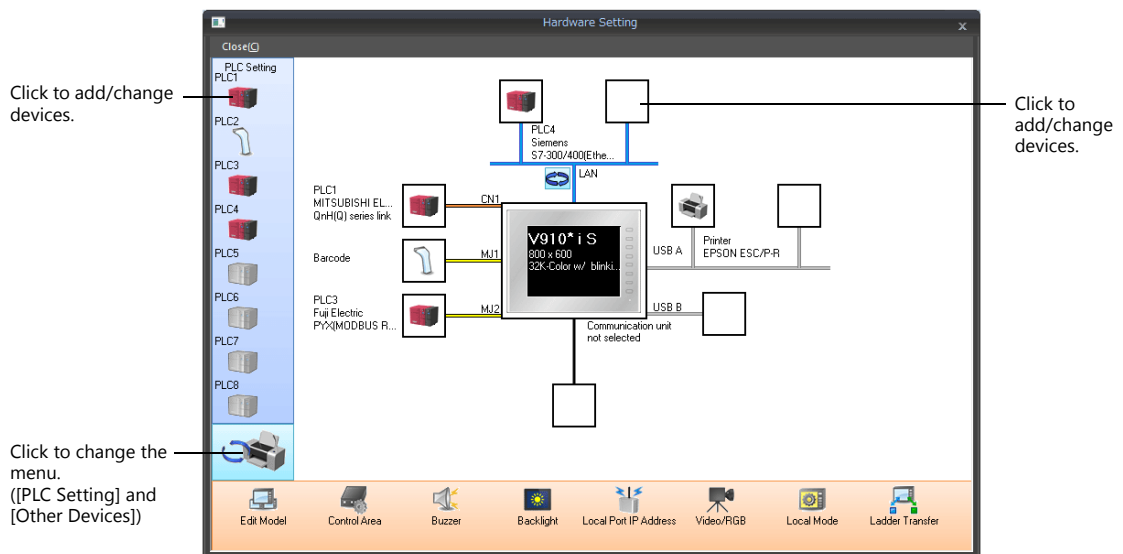

## PLC Settings and Other Devices (Left Menu)

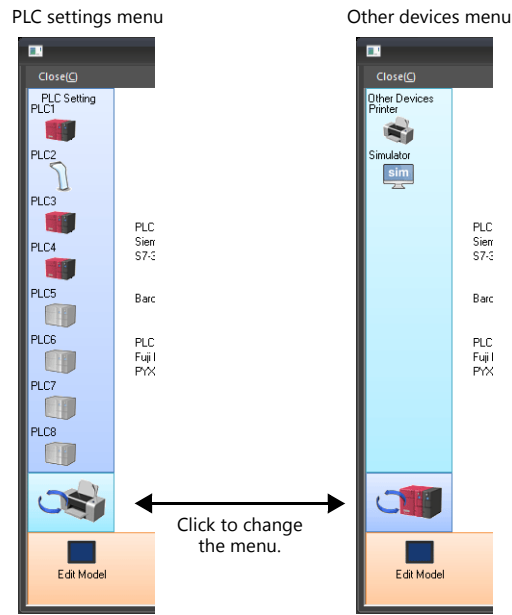

Item	Description	Refer to
PLC1 - 8	Configure settings for PLCs, temperature controllers, and inverters etc. Depending on the device connected, the available connection modes vary.	V9 Series Connection Manual
Printer	Set this option when connecting a printer for hard copies, data sheet printing, or logging data printing.	"16 Print"
Simulator	Set this option when the simulator communication program and the screen program are to be saved to a storage device using the storage manager application.	-

## Edit Model and Other Options (Bottom Menu)

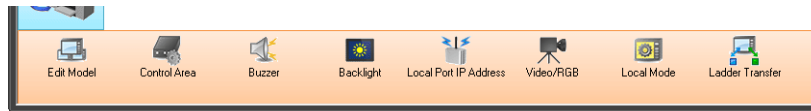

Item	Description	Refer to
Edit Model	Select the model of the V9 series for which you wish to configure a screen program.	"Edit Model Selection" page 1-2
Control Area	Configure the control area.	"Control area" page 1-23
Buzzer	Set the buzzer sound used by the V9 series unit.	"Buzzer" page 1-8
Backlight	Configure how the backlight is controlled by the V9 series unit.	"Backlight" page 1-7
Local Port IP Address	Configure the IP address, port number and other settings of the V9 series unit. This is useful when the IP address is specific to the V9 series unit on which the screen program is used.	V9 Series Reference Manual 2 6 Ethernet Communication Function
Video/RGB	Configure video/RGB input settings.	V9 Series Reference Manual 2 1.1 Video/RGB Display
Local Mode	Prohibit configuration of settings in Local mode.	"Local Mode Prohibition Setting" page 1-19
Ladder Transfer	Configure the ladder transfer settings.	V9 Series Reference Manual 2 12 Ladder Transfer

## Control area

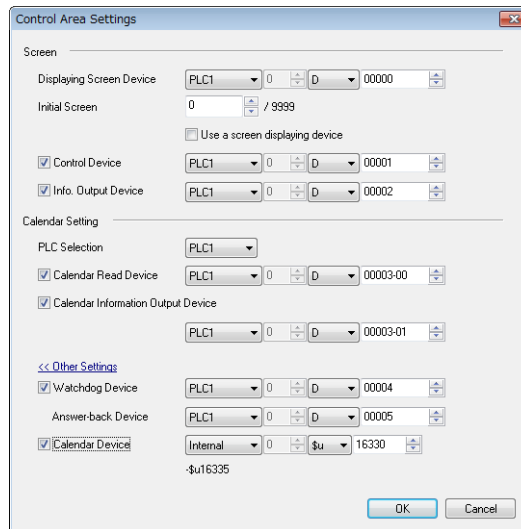

Item	Description																																		
Displaying Screen Device	<p>This device is used for switching the screen via an external command. When a screen number is specified to this device memory, the screen is displayed.</p> <table border="1" style="margin-left: auto; margin-right: auto;"> <tr> <td style="text-align: center;">MSB</td> <td style="text-align: center;">LSB</td> </tr> <tr> <td style="text-align: center;">15</td><td style="text-align: center;">14</td><td style="text-align: center;">13</td><td style="text-align: center;">12</td><td style="text-align: center;">11</td><td style="text-align: center;">10</td><td style="text-align: center;">09</td><td style="text-align: center;">08</td><td style="text-align: center;">07</td><td style="text-align: center;">06</td><td style="text-align: center;">05</td><td style="text-align: center;">04</td><td style="text-align: center;">03</td><td style="text-align: center;">02</td><td style="text-align: center;">01</td><td style="text-align: center;">00</td> </tr> <tr> <td style="text-align: center;"> </td><td style="text-align: center;"> </td><td style="text-align: center;"> </td><td style="text-align: center;"> </td><td style="text-align: center;"> </td><td style="text-align: center;"> </td><td style="text-align: center;"> </td><td style="text-align: center;"> </td><td style="text-align: center;"> </td><td style="text-align: center;"> </td><td style="text-align: center;"> </td><td style="text-align: center;"> </td><td style="text-align: center;"> </td><td style="text-align: center;"> </td><td style="text-align: center;"> </td><td style="text-align: center;"> </td> </tr> </table> <p style="text-align: right;">Screen numbers 0 to 9999</p>	MSB	LSB	15	14	13	12	11	10	09	08	07	06	05	04	03	02	01	00																
MSB	LSB																																		
15	14	13	12	11	10	09	08	07	06	05	04	03	02	01	00																				
Initial Screen	<p>Specify the screen number to display when power to MONITOUCH is turned on. If a nonexistent screen number is specified, the lowest screen number in the screen program is displayed.</p> <p>Use a screen displaying device Display the screen of the number stored in the [Displaying Screen Device] memory.</p>																																		
Control Device	<table border="1" style="margin-left: auto; margin-right: auto;"> <tr> <td style="text-align: center;">MSB</td> <td style="text-align: center;">LSB</td> </tr> <tr> <td style="text-align: center;">15</td><td style="text-align: center;">14</td><td style="text-align: center;">13</td><td style="text-align: center;">12</td><td style="text-align: center;">11</td><td style="text-align: center;">10</td><td style="text-align: center;">09</td><td style="text-align: center;">08</td><td style="text-align: center;">07</td><td style="text-align: center;">06</td><td style="text-align: center;">05</td><td style="text-align: center;">04</td><td style="text-align: center;">03</td><td style="text-align: center;">02</td><td style="text-align: center;">01</td><td style="text-align: center;">00</td> </tr> <tr> <td style="text-align: center;">0</td><td style="text-align: center;">0</td><td style="text-align: center;">0</td><td style="text-align: center;">0</td><td style="text-align: center;">0</td><td style="text-align: center;">0</td><td style="text-align: center;">0</td><td style="text-align: center;">0</td><td style="text-align: center;">0</td><td style="text-align: center;">0</td><td style="text-align: center;">0</td><td style="text-align: center;">0</td><td style="text-align: center;">0</td><td style="text-align: center;">0</td><td style="text-align: center;"> </td><td style="text-align: center;"> </td> </tr> </table> <p style="text-align: center;">Not used (always set to "0")</p> <p style="text-align: right;">Data read refresh 0 → 1: Execute</p> <p style="text-align: right;">Change the screen number using a switch 1: Prohibited, 0: Permitted</p>	MSB	LSB	15	14	13	12	11	10	09	08	07	06	05	04	03	02	01	00	0	0	0	0	0	0	0	0	0	0	0	0	0	0		
MSB	LSB																																		
15	14	13	12	11	10	09	08	07	06	05	04	03	02	01	00																				
0	0	0	0	0	0	0	0	0	0	0	0	0	0																						
	<table border="1" style="width: 100%;"> <tr> <td style="width: 20%;">Change the screen number using a switch</td> <td>Changeover screens using a switch with [Screen Change-over] or [Return] set for [Function]. [0]: Allow changeover [1]: Prohibit changeover</td> </tr> <tr> <td>Data read refresh</td> <td>All the data display items on the screen are refreshed when the bit changes from 0 to 1. This is applied to every data display item regardless of the setting for [Process Cycle]. For details on [Process Cycle], refer to "1.2 Process Cycle".</td> </tr> </table>	Change the screen number using a switch	Changeover screens using a switch with [Screen Change-over] or [Return] set for [Function]. [0]: Allow changeover [1]: Prohibit changeover	Data read refresh	All the data display items on the screen are refreshed when the bit changes from 0 to 1. This is applied to every data display item regardless of the setting for [Process Cycle]. For details on [Process Cycle], refer to "1.2 Process Cycle".																														
Change the screen number using a switch	Changeover screens using a switch with [Screen Change-over] or [Return] set for [Function]. [0]: Allow changeover [1]: Prohibit changeover																																		
Data read refresh	All the data display items on the screen are refreshed when the bit changes from 0 to 1. This is applied to every data display item regardless of the setting for [Process Cycle]. For details on [Process Cycle], refer to "1.2 Process Cycle".																																		
Info. Output Device	This device stores the state of the [Control Device].																																		
PLC Selection	Set the reading target of the calendar. PLC 1 to 8																																		

Item	Description																																																
<p>Calendar Read Device</p>	<div style="text-align: center;"> <table border="1" style="margin: auto;"> <tr> <td colspan="10" style="text-align: left;">MSB</td> <td colspan="6" style="text-align: right;">LSB</td> </tr> <tr> <td>15</td><td>14</td><td>13</td><td>12</td><td>11</td><td>10</td><td>09</td><td>08</td><td>07</td><td>06</td><td>05</td><td>04</td><td>03</td><td>02</td><td>01</td><td>00</td> </tr> <tr> <td>0</td><td>0</td><td>0</td><td>0</td><td>0</td><td>0</td><td>0</td><td>0</td><td>0</td><td>0</td><td>0</td><td>0</td><td>0</td><td>0</td><td>0</td><td>0</td> </tr> </table> <p style="text-align: center;">Not used (always set to "0")</p> <p style="text-align: right;">Calendar setting 0 → 1: Read</p> </div>	MSB										LSB						15	14	13	12	11	10	09	08	07	06	05	04	03	02	01	00	0	0	0	0	0	0	0	0	0	0	0	0	0	0	0	0
MSB										LSB																																							
15	14	13	12	11	10	09	08	07	06	05	04	03	02	01	00																																		
0	0	0	0	0	0	0	0	0	0	0	0	0	0	0	0																																		
<p>Calendar setting</p>	<p>This bit is valid when the built-in clock of the V9 series unit is not used. This bit should be used differently depending on whether the connected PLC is equipped with a calendar function. For details on the built-in clock, refer to <a href="#">"10 Calendar"</a>.</p> <p>When connecting to a PLC with a calendar function When calendar data in the PLC is updated, it can be forcibly read by setting this bit to ON (when 0 changes to 1). In addition, calendar data is also read at the following timings.</p> <ul style="list-style-type: none"> <li>- At power-on</li> <li>- When the date changes (00:00:00 AM)</li> </ul> <p>When connected to a PLC without a calendar function Allocate a tentative calendar data area by specifying a device for [Calendar Device] and set the calendar data by setting this bit to ON. For details, refer to <a href="#">"10 Calendar"</a>.</p>																																																
<p>Calendar Information Output Device</p>	<p>This device memory stores the state of the [Calendar Read Device] memory.</p>																																																
<p>Watchdog Device Answer-back Device</p>	<p>When any data is saved to [Watchdog Device], the same data is also written to [Answer-back Device] after the screen display operation is complete. In addition to watch dog monitoring, these device memory addresses can be used for display scanning.</p>																																																
<p>Calendar Device</p>	<p>For details, refer to <a href="#">"10 Calendar"</a>.</p>																																																

## 1.1.4 Common Setting

This section explains the global settings.

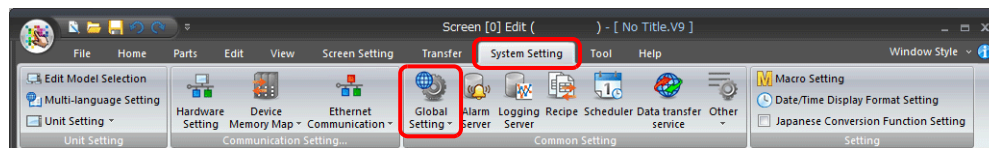

For information on other settings, refer to "1.1.1 System Setting" page 1-1.

## Global Setting

### Global Function Switch Setting

The V9 series has function switches from [F1] to [F7] ([F1] to [F5] on the V9060iT). These switches can be used on all screens in RUN mode.



- Global settings are not available on the V910xiW/V907xiW because these models do not have function switches.
- The unit changes to system menu operation mode when the system menu is displayed by pressing the [SYSTEM] switch.
- When a screen with a local function switch setting is displayed, the setting of local function switch has priority.

Location of setting: [Screen Setting] → [Local Function Switch Setting]

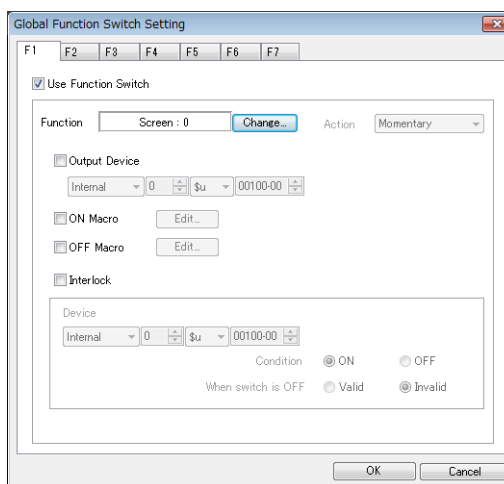

Item	Description
Use Function Switch	Select this checkbox to use the corresponding global function switch.
Function	Set the function of the switch.
Action	This option is available when the [Output Device] checkbox is selected. Select the write operation for the output device memory.
Output Device	When the switch is pressed, output information is written into the specified device memory.
ON Macro	Set the ON macro for the function switch. For details on macros, refer to the V9 Series Macro Reference Manual.
OFF Macro	Set the OFF macro for the function switch. For details on macros, refer to the V9 Series Macro Reference Manual.
Interlock	Set an interlock to the function switch.

## 1.1.5 Settings

This section explains the date and time display settings.

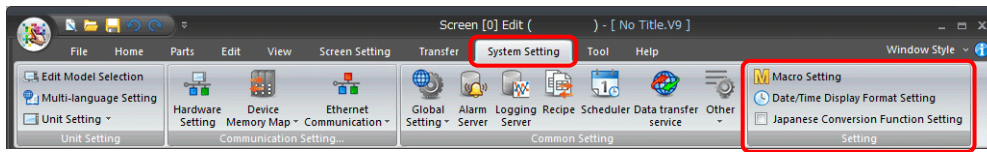

For information on other settings, refer to [“1.1.1 System Setting” page 1-1](#).

## Date and Time Display Setting

Use these settings to define a calendar data format.

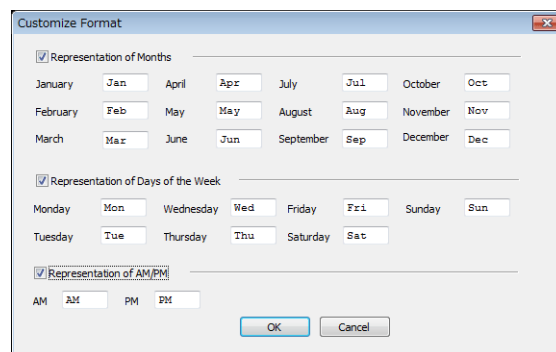
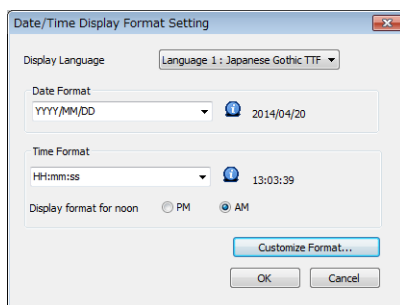

For details, refer to [“8.3 Date and Time Display Setting”](#).

## 1.2 Process Cycle

The screen display speed during communication between the V9 series unit and the PLC depends on the number of parts (mainly the number of device memory addresses read from PLC) placed on the screen.

When displaying more parts on the screen, the display speed and switch response may be slower. In such a case, it is possible to speed up the display process by differentiating between the data to be viewed in real time (high speed) and other parts (low speed). This setting can be made at [Detail] → [Process Cycle] in the settings window of each part.

### 1.2.1 Setting the Processing Cycle

The read timing of PLC device memory addresses can be set. (A lamp part is used in the following example.)

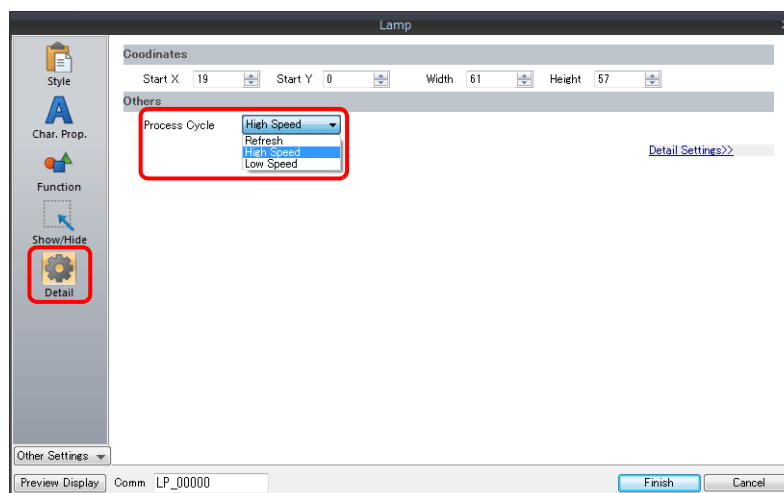

Item	Description																
Refresh	<ul style="list-style-type: none"> <li>One cycle when the screen is opened</li> <li>Bit 1 of [Control Device]: OFF → ON *</li> </ul> <div style="text-align: right;"> <table border="1" style="display: inline-table; margin-right: 20px;"> <tr> <td>15</td><td>14</td><td>13</td><td>12</td><td>11</td><td>10</td><td>09</td><td>08</td><td>07</td><td>06</td><td>05</td><td>04</td><td>03</td><td>02</td><td>01</td><td>00</td> </tr> </table>           Data read refresh <input type="checkbox"/> executed at OFF → ON         </div>	15	14	13	12	11	10	09	08	07	06	05	04	03	02	01	00
15	14	13	12	11	10	09	08	07	06	05	04	03	02	01	00		
High Speed	<ul style="list-style-type: none"> <li>Every cycle</li> </ul>																
Low Speed	<ul style="list-style-type: none"> <li>Once per several cycles. (For details, refer to <a href="#">page 1-29</a>.)</li> <li>One cycle when the screen is opened</li> <li>Bit 1 of [Control Device]: OFF → ON *</li> </ul> <div style="text-align: right;"> <table border="1" style="display: inline-table; margin-right: 20px;"> <tr> <td>15</td><td>14</td><td>13</td><td>12</td><td>11</td><td>10</td><td>09</td><td>08</td><td>07</td><td>06</td><td>05</td><td>04</td><td>03</td><td>02</td><td>01</td><td>00</td> </tr> </table>           Data read refresh <input type="checkbox"/> executed at OFF → ON         </div>	15	14	13	12	11	10	09	08	07	06	05	04	03	02	01	00
15	14	13	12	11	10	09	08	07	06	05	04	03	02	01	00		

\* Location of [Control Area] settings: [System Setting] → [Hardware Setting] → [Control Area]

For details, refer to "Control area" page 1-23.

- When the [System Setting] → [Unit Setting] → [General Setting] → [Use read/write area] checkbox is selected, bit 15 of the read area "n + 1" is changed from OFF to ON.

### Exceptions

- Regardless of the process cycle setting, all data is read in the first cycle when a screen is opened and when bit 1 of the control device memory changes from OFF to ON. With this operation, all data is displayed on the screen when the screen is opened.
- When [Internal] is selected for the device memory, [High Speed] is automatically selected for [Process Cycle] regardless of any other settings.



## 1.2.2 Processing Sequence in the V9 Series

Processing in the V9 series unit is performed in the following order.

- Device memory that frequently perform reading are put into communication cycle blocks and optimized. This improves processing speed.
- PLC device memory registered to a screen are analyzed and put into blocks for reading.
- All blocks corresponding to data set as high-speed are read in one cycle.
- Data set as low-speed is read at one block per cycle. The next block is read in the following cycle.

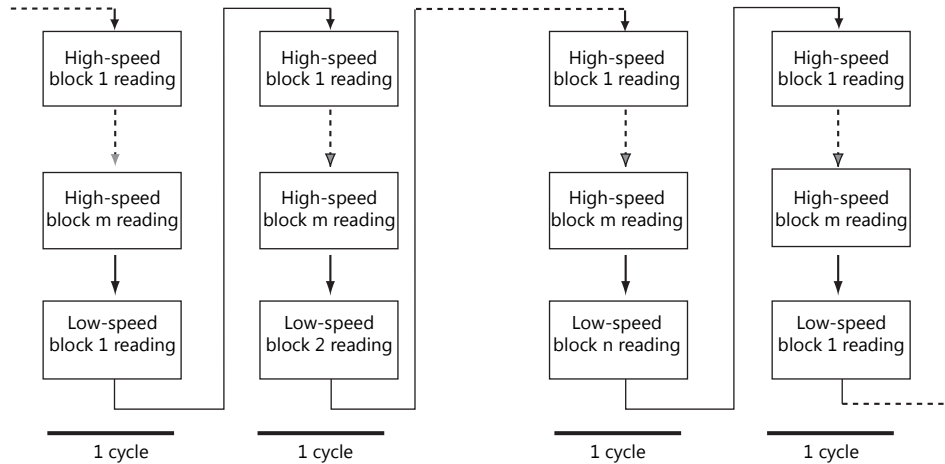

\* Reading of the control device memory is included in a high-speed block from 1 to m.

- When bit 1 of [Control Area] → [Control Device] is detected as ON, all data is read in the next cycle regardless of the settings.

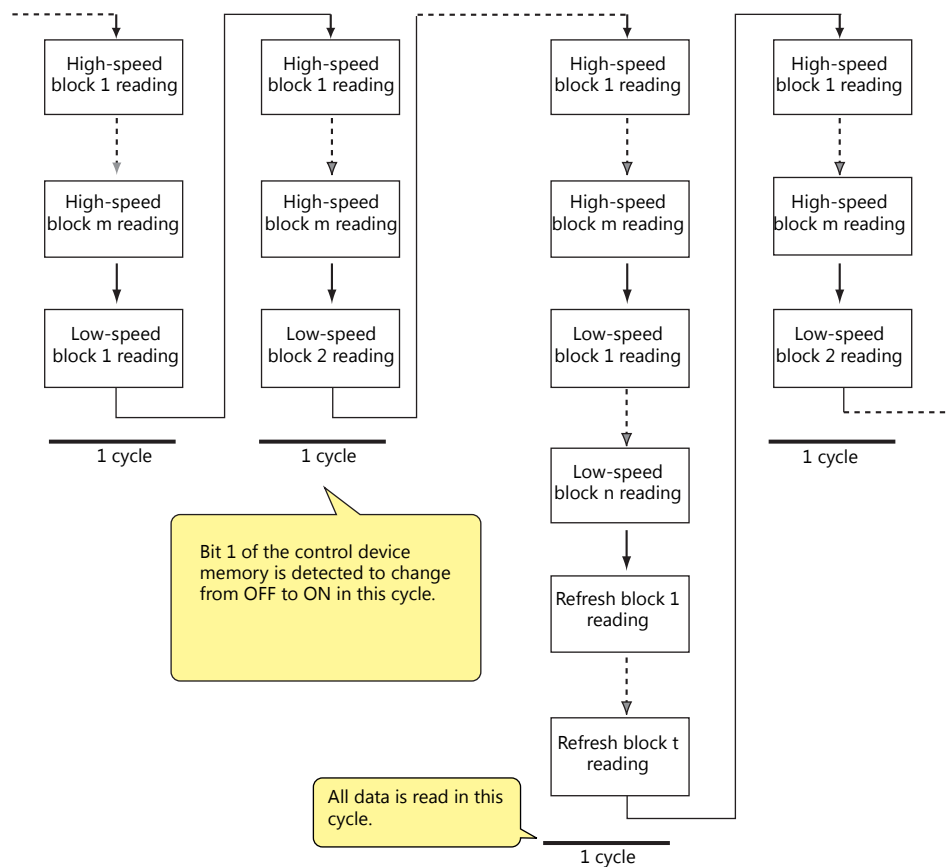

- Reading of the device memory required for display and operation is performed at the same time using two programs.
- Writing of switch activation and other operations is performed in the interval between reading blocks.

## One-cycle Processing

Communication cycles, system cycles, and drawing cycles are performed independently on the V9 series. In the communication cycle, the data of device memory set on the currently displayed screen is read. System cycle and drawing cycle processing is performed based on the data read in the communication cycle. On the initial display of screens and multi-/global overlaps, display is performed after reading all of the device memory necessary for display. After display, operation is performed with the following cycles.

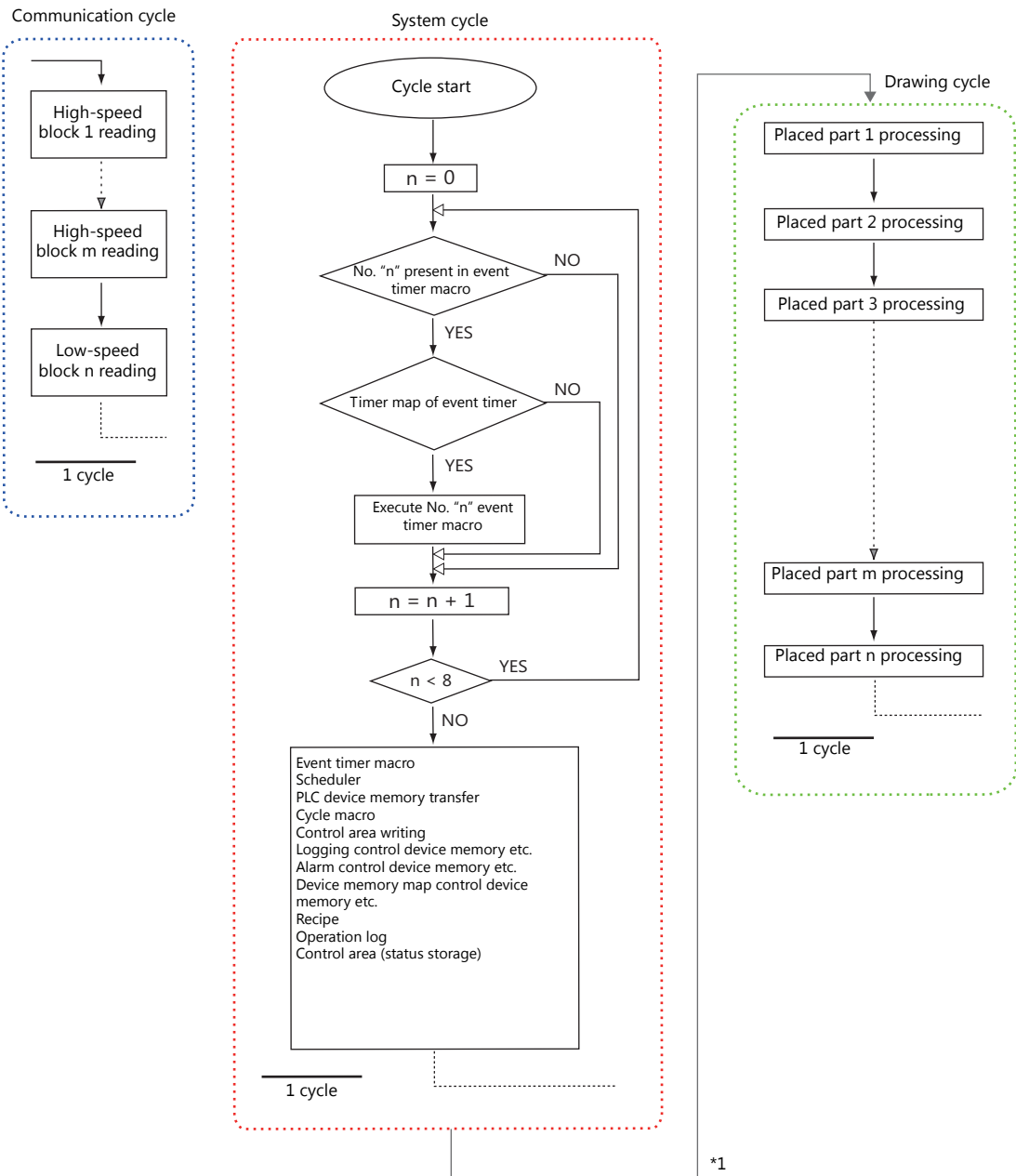

\*1 When the [System Setting] → [Unit Setting] → [General Setting] → [Synchronize system cycle and drawing cycle (V8 compatible)] checkbox is selected, the drawing cycle is performed after the system cycle is complete.

### Notes

Processing is not exactly the same as shown above because for the single cycle executed when the screen is opened, the data of all parts placed on the screen is read in addition to the execution of the screen OPEN macro.

## 1.2.3 If Communication is Slow

Try the following methods to speed up communication.

### Methods for Creating Screens

Method		Effect
Consecutively allocate PLC device memory addresses that are used for the same screen.		The number of blocks decreases so the cycle time can be shorter.
Parts	Change the [Process Cycle] setting. *1	The number of accesses to the PLC can be reduced.
Macro	Refine commands. *2	The number of accesses to the PLC with macros can be reduced.
Logging Alarm	When specifying device memory addresses individually, allocate the addresses consecutively.	The number of blocks decreases so the cycle time can be shorter.
Multi-link Multi-link2	Place all connected V9 series units in RUN mode.	This eliminates recovery confirmation access on ports where communication is not possible.

\*1 Example of changing [Process Cycle]:

- For data display parts where data is written from such as a keypad, and there are no or hardly any changes in the PLC, select [Refresh].
- For data display parts where the display speed on the V9 series unit does not need to be fast in response to data changes in the PLC, select [Low Speed].
- For data display parts that must be displayed in real time, select [High Speed].

\*2 Example of refining macro commands:

[MOV] command, 5 lines

Line No. 0 D200 = \$u200 (W)

Line No. 1 D201 = \$u201 (W)

Line No. 2 D202 = \$u202 (W)

Line No. 3 D203 = \$u203 (W)

Line No. 4 D204 = \$u204 (W)

PLC is written to five times



Change to the [BMOV] command

[BMOV] command, 1 line

Line No. 0 D200 = \$u200 C: 5 (BMOV)

PLC is written to only once.

### Others

- Baud rate setting (serial communications)  
Increase the baud rate between the V9 series unit and the PLC. The V9 series unit supports a maximum of 115 kbps (direct connection with Siemens MPI port: maximum 187,500 bps). Set the maximum baud rate that the PLC supports.
- Ethernet communication  
The baud rate available with Ethernet communication is 100 Mbps or 10 Mbps (depending on the PLC model). This allows for faster communication than serial communication.
- On the PLC, set a shorter scan time for ladder programs.

## 1.3 List of Internal Device Memory

Internal device memory is the device memory in the V9 series unit that is available to users.

Since processing is done internally within the V9 series unit, communication speed can be made quicker by using for operations that do not require data communication with a PLC.

### 1.3.1 Types of Internal Device Memory

Internal device memory can be generally divided into two types: user device memory and system device memory.



- Internal device memory operate with "DEC (with sign)" regardless of the numeric code set via the [System Setting] → [Hardware Setting] window. (Except items for which the numeric code is specified individually.)
- Text processing depends on the setting for [Text Process] under [Communication Setting] in the [System Setting] → [Hardware Setting] window.

### User Device Memory

These device memory allow read/write operations and can be used freely by users.

Symbol	Range	Description
\$u *1	0 - 32767 (32768 words)	This is an area common to all screens.
\$L \$LD *2	Depends on user setting	This is an area common to all screens.
\$T *1	0 - 1023 (1024 words)	Each screen can have up to 1024 words. When the screen is switched, all the areas are reset to "0". Therefore, these device memory can be used for macro commands executed for each screen.
\$M *1	0 - 2047 (2048 words)	Each macro command can have up to 2048 words. When the macro command has been executed, or another macro command is called, all the areas are reset to "0". Therefore, these device memory can be used for macro commands that are executed on a macro basis.
\$MC *1	0 - 2047 (2048 bytes)	Each macro command can have up to 2048 bytes. When the macro command has been executed, or another macro command is called, all the areas are reset to "0". Therefore, these device memory can be used for macro commands that are executed on a macro basis. The difference from \$M is that these are device memory in byte units, which makes byte access possible.
\$C *1	0 - 4095 (4096 words)	These device memory addresses are exclusively used for component parts. These are available only when editing component parts.

\*1 \$u, \$T, \$M, and \$MC are volatile device memory. When switched to Local mode or the power is turned off (reset), data is erased.

\*2 \$L and \$LD are non-volatile device memory. Data is retained even after the power is turned off. To use \$L or \$LD, it is necessary to make [SRAM/Clock] settings.



For details, refer to "SRAM/Clock" page 1-5.

### System Device Memory

This device memory is for use by the system and there two types: device memory for reading and device memory for writing.

Symbol	Range	Description
\$s *1	0 - 2047 (2048 words)	This device memory is used for performing input and output with the system using, for example, macro commands. <u>Do not use device memory addresses indicated with "Not used" because they may be reserved for future use.</u>
\$P *1	0 - 511 (512 words)	This read/write device memory is used to control 8-way communication or indicate the status of 8-way communication. For details, refer to the V9 Series Connection Manual.

\*1 \$s and \$P are volatile device memory. When switched to Local mode or the power is turned off (reset), data is erased.



For details on \$s, refer to "1.3.2 System Device Memory Details" page 1-32.  
For details on \$P, refer to the V9 Series Connection Manual.

## 1.3.2 System Device Memory Details

The details of the \$s system device memory are shown below.

### Meaning of “Device Type” in the table

- ← V Data written to \$s from MONITOUCH
- → V Definitions and settings written to \$s by the user

### Table

\$s	Description		Device Type	Refer to	
0	Stores the currently displayed screen number (0 to 9999).		← V	-	
1					
2	Overlap 0	Registration/display status	← V	<a href="#">page 1-44</a>	
3	Overlap 0	Display position X			
4	Overlap 0	Display position Y			
5	Overlap 0	Overlap library number			
6	Overlap 1	Registration/display status			
7	Overlap 1	Display position X			
8	Overlap 1	Display position Y			
9	Overlap 1	Overlap library number			
10	Overlap 2	Registration/display status			
11	Overlap 2	Display position X			
12	Overlap 2	Display position Y			
13	Overlap 2	Overlap library number			
14					
15					
16	Printer status		← V	<a href="#">page 1-44</a>	
17	Backlight status			<a href="#">page 1-44</a>	
18					
19					
20	V7 compatible	Buffer 0	Specified number of buffers	← V	<a href="#">page 1-44</a>
21		Buffer 0	Number of buffers		
22		Buffer 0	Executed number of buffers		
23		Buffer 1	Specified number of buffers		
24		Buffer 1	Number of buffers		
25		Buffer 1	Executed number of buffers		
26		Buffer 2	Specified number of buffers		
27		Buffer 2	Number of buffers		
28		Buffer 2	Executed number of buffers		
29		Buffer 3	Specified number of buffers		
30		Buffer 3	Number of buffers		
31		Buffer 3	Executed number of buffers		
32		Buffer 4	Specified number of buffers		
33		Buffer 4	Number of buffers		
34		Buffer 4	Executed number of buffers		
35	Buffer 5	Specified number of buffers			
36	Buffer 5	Number of buffers			
37	Buffer 5	Executed number of buffers			
38	Buffer 6	Specified number of buffers			
39	Buffer 6	Number of buffers			
40	Buffer 6	Executed number of buffers			
41	Buffer 7	Specified number of buffers			
42	Buffer 7	Number of buffers			
43	Buffer 7	Executed number of buffers			

\$s	Description		Device Type	Refer to
44	V7 compatible	Buffer 8	← V	page 1-44
45		Buffer 8		
46		Buffer 8		
47		Buffer 9		
48		Buffer 9		
49		Buffer 9		
50		Buffer 10		
51		Buffer 10		
52		Buffer 10		
53		Buffer 11		
54		Buffer 11		
55		Buffer 11		
⋮	(Blank)			
64	Switch function Repeat setting Adds the repeat function to a switch not configured with the repeat function. Set a number other than "0" to the switch ON macro.		→ V	-
65	Switch function Repeat prohibited setting Prohibits the repeat function for a switch configured with the repeat function. Set a number other than "0" to the switch ON macro.			-
66	Switch ON	Macro repeat setting		page 1-44
⋮	(Blank)			
72	Stores the result of the "SYS" (system call) macro command. 0: Normal termination Other than 0 (usually -1): Error (second screen setting, etc.)		← V	-
73	Result of switch function Stores the operation result of the switch function when the "SWRET" command is used with the switch ON macro. Use this device memory when the next operation varies depending on the result of the switch function. 0: Normal termination Other than 0 (usually -1): Error			-
74				
75	Buzzer sound for overlap		→ V	page 1-45
76	Keypad overlap AUTO OFF Prohibited If a keypad is placed on an overlap display, it is possible to close the overlap display with the [ENT] key on the keypad. This device memory can be used to prohibit this function. 0: Permitted Other than 0: Prohibited		→ V	-
77	Exclusive function of overlap display When a value other than "0" is set, the overlap exclusive function is set.			"2 Overlaps"
78	Entry mode Display type of entry target		← V	page 1-45
79	Entry mode Selection of entry target		→ V	page 1-45
80	Universal serial	Switch output 0	← V	V9 Series Connection Manual
81	Universal serial	Switch output 1		
82	Universal serial	Switch output 2		
83	Universal serial	Switch output 3		
84	Universal serial	Switch output 4		
85	Universal serial	Switch output 5		
86	Universal serial	Switch output 6		
87	Universal serial	Switch output 7		
88	Universal serial	Switch output 8		
89	Universal serial	Switch output 9		
90	Universal serial	Switch output 10		
91	Universal serial	Switch output 11		
92	Universal serial	Switch output 12		
93	Universal serial	Switch output 13		
94	Universal serial	Switch output 14		
95	Universal serial	Switch output 15		
⋮	(Blank)			
99	"CVFD" macro command setting		→ V	page 1-45

# 1 System

\$s	Description	Device Type	Refer to
100	PLC calendar status The calendar status of the PLC (with built-in calendar) is written. 0: Normal 1: Error (The calendar information could not be read correctly.)	← V	-
101	Setting for writing calendar data to PLC When \$s100 = 1, writing calendar data to the PLC is permitted or prohibited. 0: Writing prohibited 1: Writing permitted at all times (No error handling is performed even if an error is detected.)	→ V	-
102	Stores the execution result of the "HMI-FUNC" macro command. 0: Normal [Other than 0]: Error	← V	Under development
103			
104	PLC error handling during macro execution	→ V	<a href="#">page 1-45</a>
105	(When \$s104 is other than 0: Result of error handling is written)		<a href="#">page 1-45</a>
106	Memo pad Page number Stores the page number (0 to 7) of the currently displayed memo pad.		-
107	Memo pad Data Registered/ Unregistered		<a href="#">page 1-46</a>
108	Memo pad Remaining storage area		-
109	Stores the amount of remaining storage area for memo pad data. (Unit: bytes)	← V	-
110	Stores the local port number of the V9 series unit for multi-link/multi-link 2 connections.		V9 Series Connection Manual
111	Stores the local port number of the V9 series unit for 1 : n connection on the universal serial port.		
112			
113			
114	V7 compatible 1 : n connection PLC1 down information (port number 32 to 47)		
115	1 : n connection PLC1 down information (port number 48 to 63)		
116	1 : n connection PLC1 down information (port number 64 to 79)		
117	1 : n connection PLC1 down information (port number 80 to 95)		
118	1 : n connection PLC1 down information (port number 96 to 111)		
119	1 : n connection PLC1 down information (port number 112 to 127)		
120	1 : n connection PLC1 down information (port number 128 to 143)		
121	1 : n connection PLC1 down information (port number 144 to 159)		
122	1 : n connection PLC1 down information (port number 160 to 175)	← V	<a href="#">page 1-46</a>
123	1 : n connection PLC1 down information (port number 176 to 191)		
124	1 : n connection PLC1 down information (port number 192 to 207)		
125	1 : n connection PLC1 down information (port number 208 to 223)		
126	1 : n connection PLC1 down information (port number 224 to 239)		
127	1 : n connection PLC1 down information (port number 240 to 255)		
128	1 : n connection PLC1 down information (port number 0 to 15)		
129	1 : n connection PLC1 down information (port number 16 to 31)		
130	MODBUS TCP/IP sub station information Specify the sub station number with the "MOV" macro command.	→ V	V9 Series Connection Manual
131			
132	Cycle time Stores the cycle time of the currently displayed screen. (Unit: 10 msec)	← V	-
⋮	(Blank)		
160	Calendar Year		
161	Calendar Month		
162	Calendar Day		
163	Calendar Hour	← V	<a href="#">page 1-46</a>
164	Calendar Minute		
165	Calendar Second		
166	Calendar Day of the week (0: Sunday, 1: Monday, 2: Tuesday, ... 6: Saturday)		
167	Battery voltage drop detection Bit 4 0: Battery normal 1: Battery voltage drop, no battery	← V	-
168	GMT-based UNIX time		
169	Stores the Greenwich Mean Time.	← V	-
⋮	(Blank)		

\$s	Description			Device Type	Refer to	
177	V8 compatible	Sampling buffer number		→ V	<a href="#">page 1-46</a>	
178		Overflow flag		← V	<a href="#">page 1-46</a>	
179						
180	V8 compatible	Buffer	Word 0	Average	← V	<a href="#">page 1-46</a>
181						
182		Buffer	Word 0	Maximum		
183						
184		Buffer	Word 0	Minimum		
185						
186		Buffer	Word 0	Total		
187						
188		Buffer	Word 1	Average		
189						
190		Buffer	Word 1	Maximum		
191						
192		Buffer	Word 1	Minimum		
193						
194		Buffer	Word 1	Total		
195						
196		Buffer	Word 2	Average		
197						
198		Buffer	Word 2	Maximum		
199						
200		Buffer	Word 2	Minimum		
201						
202		Buffer	Word 2	Total		
203						
204 - 211		Buffer	Word 3	Average, maximum, minimum, total		
212 - 219		Buffer	Word 4	Average, maximum, minimum, total		
220 - 227	Buffer	Word 5	Average, maximum, minimum, total			
228 - 235	Buffer	Word 6	Average, maximum, minimum, total			
236 - 243	Buffer	Word 7	Average, maximum, minimum, total			
244 - 251	Buffer	Word 8	Average, maximum, minimum, total			
252 - 259	Buffer	Word 9	Average, maximum, minimum, total			
260 - 267	Buffer	Word 10	Average, maximum, minimum, total			
268 - 275	Buffer	Word 11	Average, maximum, minimum, total			
276 - 283	Buffer	Word 12	Average, maximum, minimum, total			
284 - 291	Buffer	Word 13	Average, maximum, minimum, total			
292 - 299	Buffer	Word 14	Average, maximum, minimum, total			
300 - 307	Buffer	Word 15	Average, maximum, minimum, total			
308 - 315	Buffer	Word 16	Average, maximum, minimum, total			
316 - 323	Buffer	Word 17	Average, maximum, minimum, total			
324 - 331	Buffer	Word 18	Average, maximum, minimum, total			
332 - 339	Buffer	Word 19	Average, maximum, minimum, total			
340 - 347	Buffer	Word 20	Average, maximum, minimum, total			
348 - 355	Buffer	Word 21	Average, maximum, minimum, total			
356 - 363	Buffer	Word 22	Average, maximum, minimum, total			
364 - 371	Buffer	Word 23	Average, maximum, minimum, total			
372 - 379	Buffer	Word 24	Average, maximum, minimum, total			
380 - 387	Buffer	Word 25	Average, maximum, minimum, total			
388 - 395	Buffer	Word 26	Average, maximum, minimum, total			



1 System

\$s	Description			Device Type	Refer to	
396 - 403	V8 compatible	Buffer	Word 27	Average, maximum, minimum, total	← V	<a href="#">page 1-46</a>
404 - 411		Buffer	Word 28	Average, maximum, minimum, total		
412 - 419		Buffer	Word 29	Average, maximum, minimum, total		
420 - 427		Buffer	Word 30	Average, maximum, minimum, total		
428 - 435		Buffer	Word 31	Average, maximum, minimum, total		
436	V8 compatible	Alarm function	Auto operation time		← V	-
437		Alarm function	Auto operation stop time			
438						
439		Alarm function	Program stop time			
440						
441						
442	Alarm function	Number of stops				
443	Alarm Function	Rate of operation(XX.X)				
⋮	(Blank)					
456	V8 compatible	Alarm Function	Normal Operation Bit		← V	-
457						
458	V8 compatible	Alarm Function	Sampling bit		← V	-
459						
460	V8 compatible	Read area	n		← V	-
461		Read area	n + 1			
462		Read area	n + 2			
463						
464	V8 compatible	Write area	n		← V	-
465		Write area	n + 1			
466		Write area	n + 2			
⋮	(Blank)					
496	Storage access status (V-Server)			← V	Under development	
0: No access						
1: Accessing						
497	Storage device error state					
498	Remaining space on storage device			← V	-	
499	Stores the amount of free space on the storage device. (Unit: kbyte)					
500	[Storage Removal] switch status			← V	-	
0: Switch OFF (removal disabled)						
Other than 0: Switch ON (removal permitted)						
⋮	(Blank)					
512	Ethernet	Port selection		→ V	-	
Select the port used for sending and receiving Ethernet macro commands ("EREAD", "EWRITE", "SEND", or "MES").						
0: LAN (built-in)						
1: Ethernet unit						
2: LAN2 (built-in)						
3: WLAN (wireless)						
513						
514	Ethernet	Result of macro wait request_		→ V	<a href="#">page 1-47</a>	
515	Ethernet	Macro wait request execution result_		← V	<a href="#">page 1-47</a>	
516	Ethernet	Transmission speed (for built-in LAN port)		← V	-	
0: Auto						
1: 10Base						
517						
518	Ethernet	Status (for built-in LAN port)		← V	V9 Series Connection Manual	
0: Normal						
Other than 0: Error number						
519	Ethernet	Status (for Ethernet unit)		← V	Under development	
* Under development						

\$s	Description	Device Type	Refer to
520	Network table 0 status	← V	V9 Series Connection Manual
521	Network table 1 status		
522	Network table 2 status		
⋮	⋮		
617	Network table 97 status		
618	Network table 98 status		
619	Network table 99 status		
⋮	(Blank)		
700	Stores the language number (0 to 15) of the currently displayed language.	← V	-
⋮	(Blank)		
720	SRAM Memo pad save result 0: Normal 1: Data contains an error and is deleted.	← V	-
721	SRAM Internal device memory \$L save result 0: Normal 1: Error		-
722	SRAM Internal device memory \$L last written device memory_ Stores the \$L address of the last write operation when \$s721 = 1 at power-up.		-
723			-
724	SRAM Internal device memory \$LD save result 0: Normal 1: Error		-
725	SRAM Internal device memory \$LD last written device memory Stores the \$LD device memory of the last write operation when \$s724 = 1 at power-up.		-
726			-
727	Memo pad save overflow (judgment result of whether data is of a size that can be saved) 0: Normal 1: Save area insufficient		-
728	FROM_RD/FROM_WR macro execution result 0: Normal 1: Error	-	
729	V7 compatible PLC2 Macro execution result	← V	V9 Series Connection Manual
730	PLC2 Port No. 00 Status		
731	PLC2 Port No. 01 Status		
732	PLC2 Port No. 02 Status		
⋮	⋮		
758	PLC2 Port No. 28 Status		
759	PLC2 Port No. 29 Status		
760	PLC2 Port No. 30 Status		
761	PLC2 Port No. 31 Status		
762	PLC2 Constant/synchronized read Interrupt setting		
763	PLC2 TEMP_RD/TEMP_WR macro forced execution setting		
764	PLC2 Constant/synchronized write Interrupt setting	← V	
765	PLC2 Error code		
766	PLC2 Extended error code 1		
767	PLC2 Extended error code 1		
768	PLC2 Extended error code 1		
⋮	(Blank)		
800	Modbus slave communication Reference table number	→ V	Modbus Slave Communication Specifications
801	Modbus slave communication Reference device memory setting		
802	Modbus slave communication Reference device memory setting		
803	Modbus slave communication Reference device memory setting		
804	Modbus slave communication Reference device memory setting		
805	Mo		
⋮	(Blank)		
810 - 813	Stores the IP address of the V9 series unit. When no IP address is set, "0.0.0.0" is stored.	← V	-
814 - 817	IP address of another port		<a href="#">page 1-47</a>
818	Network table number designation	→ V	<a href="#">page 1-47</a>
819			

## 1 System

\$s	Description			Device Type	Refer to	
820	V7 compatible	PLC2	Port No. 32	Status	← V	V9 Series Connection Manual
821		PLC2	Port No. 33	Status		
822		PLC2	Port No. 34	Status		
⋮		⋮				
885		PLC2	Port No. 97	Status		
886		PLC2	Port No. 98	Status		
887		PLC2	Port No. 99	Status		
888						
889						
890	Japanese conversion function Number of user-defined words			← V	-	
⋮	(Blank)					
900	Stores the touch switch status.			← V	"3.1.6 Coordinate Output"	
901	Touch switch X coordinate output Stores the X coordinate of the touch switch that is pressed.					
902	Touch switch Y coordinate output Stores the Y coordinate of the touch switch that is pressed.					
⋮	(Blank)					
910	Video CH1 Brightness			← V	V9 Series Reference Manual 2 1.1 Video/RGB Display	
911	Video CH1 Contrast					
912	Video CH1 Color intensity					
⋮	(Blank)					
930	Video status			← V	V9 Series Reference Manual 2 1.1 Video/RGB Display	
⋮	(Blank)					
932	Video Automatic Stores the snapshot file number.			← V	V9 Series Reference Manual 2 1.1 Video/RGB Display	
⋮	(Blank)					
935	Video Brightness of the selected video area			← V	V9 Series Reference Manual 2 1.1 Video/RGB Display	
936	Video Contrast of the selected video area					
937	Video Color intensity of the selected video area					
⋮	(Blank)					
956	Stores the current brightness adjustment value (0 to 127).			← V	-	
957	Video Display change (640 × 240 dots only) 0: Upper half display 1: Lower half display			→ V	V9 Series Reference Manual 2 1.1 Video/RGB Display	
⋮	(Blank)					
961	Video Standard size setting (for V9150iX only) 0: 640 × 480 1: 800 × 600 2: 1024 × 768			→ V	V9 Series Reference Manual 2 1.1 Video/RGB Display	
962	Video Number of periodic snapshots executed Cleared to 0 when taking of snapshots starts.			← V		
⋮	(Blank)					
965	File transfer communication timeout setting Set the monitoring timeout time when storage device of MONITOUCH is accessed from a client, such as V-Server, storage access DLL etc., in RUN mode. Set value is 0: 60 sec (default) Set value is other than 0: Set value × 10 sec			→ V	Under development	

\$s	Description	Device Type	Refer to
966	Video Current clip start position (X coordinate at the top left corner)	← V	V9 Series Reference Manual 2 1.1 Video/RGB Display
967	Video Current clip start position (Y coordinate at the top left corner)		
968	Video Current image clip size (width)		
969	Video Current image clip size (height)		
970	RGN IN Limit on number of snapshot executions using SET_RGB macro Setting value: 0 to 255	→ V	
971	RGB IN Processing to perform when the number of snapshot executions exceed the limit specified with \$s970 0: Stop 1: Continue		
⋮	(Blank)		
990	Recipe GET_RECIPE_FILEINFO macro execution result	← V	V9 Series Macro Reference Manual
⋮	(Blank)		
1000	Audio Stores the remaining seconds of audio playback.	← V	V9 Series Reference Manual 2 "2 Sound"
1001	Audio Stores the adjusted volume value of channel L.		
1002	Audio Stores the adjusted volume value of channel R.		
1003			
1004			
1005	E-mail send Number of e-mails waiting to be sent	← V	V9 Series Reference Manual 2 "6.8 E-mail Notification"
1006	E-mail send Error information		
1007	EPSON ESC/P-R supported Hard copy	→ V	Under development
1008	JPEG Used to set accuracy of reduced JPEG images.		V9 Series Reference Manual 2 "1.1 JPEG Display"
1009	Data sheet Consecutive printing (STA_LIST macro command) 0: Prohibited 1: Permitted	→ V	-
1010	Data sheet Number of data sheets in print queue (STA_LIST macro command)_ Stores the number of data sheets in printing queue.(eight maximum) * Enabled when \$s1009 = 1. If the "STA_LIST" macro command is executed while eight data sheets are already in the queue, a macro execution error occurs.	← V	-
1011	Data sheet Cancel (STA_LIST macro command) Specifying "1" cancels the printing of data sheets in the queue. The value is automatically reset to "0" after cancellation. * Enabled when \$s1009 = 1.	→ V / ← V	-
⋮	(Blank)		
1024	External storage device access result Stores the result of when a file on a storage device of MONITOUCH is accessed from a client, such as V-Server, storage access DLL etc., in RUN mode. 0: Normal -1: Error	← V	Under development
⋮	(Blank)		
1030	Built-in socket (drive: C) Storage device error state	← V	<a href="#">page 1-47</a>
1031	Built-in socket (drive: C) Remaining space on storage device		-
1032	Stores the amount of free space on the storage device. (Unit: kbyte)		-
1033	Built-in socket (drive: C) [Storage Removal] switch status 0: Switch OFF (removal prohibited) Other than 0: Switch ON (removal permitted)		-
1034			
1035	USB-A (drive: D) Storage device error state	← V	<a href="#">page 1-47</a>
1036	USB-A (drive: D) Remaining space on storage device		-
1037	Stores the amount of free space on the storage device. (Unit: kbyte)		-
1038	USB-A (drive: D) [Storage Removal] switch status 0: Switch OFF (removal prohibited) Other than 0: Switch ON (removal permitted)		-
⋮	(Blank)		
1050	Background Storage device access Background processing flag	← V	<a href="#">page 1-48</a>
1051	Background Storage device access Background processing completion flag		<a href="#">page 1-48</a>
1052	Background Storage device access Background processing error flag		<a href="#">page 1-48</a>
1053			

1 System

\$\$	Description		Device Type	Refer to
1054				
1055				
1056	Macro execution result	Arithmetic operation	← V	V9 Series Macro Reference Manual
1057	Macro execution result	Conversion, transfer		
1058	Macro execution result	Comparison		
1059	Macro execution result	Macro operation control		
1060	Macro execution result	Printer		
1061				
1062	Macro execution result	Storage device		
1063	Macro execution result	Others		
1064				
1065				
1066	PictBridge	Status output	← V	<a href="#">page 1-48</a>
⋮	(Blank)			
1070	Stores FTP information.		← V	V9 Series Reference Manual 2 "6.9 FTP Server"
1071	FTP client	Stores the number of FTP clients logged into the server (maximum of 3 clients).	← V	
1072	FTP connection	Forcibly disconnect the connection.	→ V	
⋮	(Blank)			
1085	SRAM forced formatting		← V	<a href="#">page 1-49</a>
⋮	(Blank)			
1098	V8 compatible	Sampling macro Background processing selection	→ V	<a href="#">page 1-49</a>
1099				
1100	V8 compatible	Buffer No. 0 Stores the number of sampling times set for the primary storage destination.	← V	-
1101		Buffer No. 0 Stores the current number of sampling times of the primary storage destination. (Set number of sampling times (\$s1100) ≥ current number of sampling times (\$s1101))		-
1102		Buffer No. 0 Stores the number of sampling times set for the secondary storage target.		-
1103				
1104		Buffer No. 0 Stores the current number of sampling times of the secondary storage destination. (Set number of sampling times (\$s1102 and 1103) ≥ current number of sampling times (\$s1104 and 1105))		-
1105				
1106		Buffer No. 0 Stores the number of sampling times executed.		-
1107				
1108		Buffer No. 0 Secondary storage destination access status		<a href="#">page 1-49</a>
1109		Buffer No. 0 Background processing flag		<a href="#">page 1-49</a>
1110	Buffer No. 0 Sampling macro executing flag	<a href="#">page 1-49</a>		
1111	Buffer No. 0 Sampling macro execution completion flag	<a href="#">page 1-49</a>		
1112	Buffer No. 0 Sampling macro error flag	<a href="#">page 1-49</a>		
1113	V8 compatible	Buffer No. 0 Sampling error flag	← V	<a href="#">page 1-49</a>
1114		Buffer No. 0 Sampling error forced storage flag	→ V	<a href="#">page 1-49</a>
⋮	(Blank)			
1120 - 1134	V8 compatible	Buffer No. 1 (Equivalent to buffer No. 0 \$s1100 to 1114)	→ V ← V	Refer to \$s1100 - 1114
⋮	(Blank)			
1140 - 1154	V8 compatible	Buffer No. 2 (Equivalent to buffer No. 0 \$s1100 to 1114)	→ V ← V	Refer to \$s1100 - 1114
⋮	(Blank)			
1160 - 1174	V8 compatible	Buffer No. 3 (Equivalent to buffer No. 0 \$s1100 to 1114)	→ V ← V	Refer to \$s1100 - 1114
⋮	(Blank)			
1180 - 1194	V8 compatible	Buffer No. 4 (Equivalent to buffer No. 0 \$s1100 to 1114)	→ V ← V	Refer to \$s1100 - 1114
⋮	(Blank)			

\$s	Description		Device Type	Refer to
1200 - 1214	V8 compatible	Buffer No. 5 (Equivalent to buffer No. 0 \$s1100 to 1114)	→ V ← V	Refer to \$s1100 - 1114
⋮	(Blank)			
1220 - 1234	V8 compatible	Buffer No. 6 (Equivalent to buffer No. 0 \$s1100 to 1114)	→ V ← V	Refer to \$s1100 - 1114
⋮	(Blank)			
1240 - 1254	V8 compatible	Buffer No. 7 (Equivalent to buffer No. 0 \$s1100 to 1114)	→ V ← V	Refer to \$s1100 - 1114
⋮	(Blank)			
1260 - 1274	V8 compatible	Buffer No. 8 (Equivalent to buffer No. 0 \$s1100 to 1114)	→ V ← V	Refer to \$s1100 - 1114
⋮	(Blank)			
1280 - 1294	V8 compatible	Buffer No. 9 (Equivalent to buffer No. 0 \$s1100 to 1114)	→ V ← V	Refer to \$s1100 - 1114
⋮	(Blank)			
1300 - 1314	V8 compatible	Buffer No. 10 (Equivalent to buffer No. 0 \$s1100 to 1114)	→ V ← V	Refer to \$s1100 - 1114
⋮	(Blank)			
1320 - 1334	V8 compatible	Buffer No. 11 (Equivalent to buffer No. 0 \$s1100 to 1114)	→ V ← V	Refer to \$s1100 - 1114
⋮	(Blank)			
1360	Security function	Stores the security level (0 to 15) of the currently logged-in user.	← V	-
1361	Security function	Stores the user ID of the currently logged-in user.		
1362				
1363				
1364				
1365	Operation log viewer	Stores the number of the log file being displayed.	← V	-
1366	Operation log viewer	Stores the number of the log folder being displayed.		-
⋮	(Blank)			
1380	Remote desktop	Stores the start-up status. 0: Hidden (disconnected) 1: Shown (connected)	← V	Under development
1381	Remote desktop	Stores the connection status_ 0 or greater: Remote desktop table No. -1: Disconnected -2: Connection failure		Under development
⋮	(Blank)			
1400	Network table 100 status		← V	V9 Series Connection Manual
1401	Network table 101 status			
1402	Network table 102 status			
⋮	⋮			
1553	Network table 253 status			
1554	Network table 254 status			
1555	Network table 255 status			
⋮	(Blank)			
1560	Global overlap	Registration/display status_	← V	<a href="#">page 1-49</a>
1561	Global overlap Dot: 0 to 1023 Column: 0 to 127	Stores the X coordinate of the global overlap display position.		-
1562	Global overlap Dot: 0 to 768 Column: 0 to 37	Stores the Y coordinate of the global overlap display position.		-
1563	Global overlap Show: 0 to 9999 Hide: -1	Stores the global overlap library number.		-
⋮	(Blank)			
1600	Drawing cycle time (msec)		← V	-

# 1 System

\$s	Description	Device Type	Refer to
1601			
1602	PLC1 read cycle time (msec)	← V	-
1603	PLC2 read cycle time (msec)		
1604	PLC3 read cycle time (msec)		
1605	PLC4 read cycle time (msec)		
1606	PLC5 read cycle time (msec)		
1607	PLC6 read cycle time (msec)		
1608	PLC7 read cycle time (msec)		
1609	PLC8 read cycle time (msec)		
⋮	(Blank)		
1617	Overlap 4 Registration/display status	← V	<a href="#">page 1-44</a>
1618	Overlap 4 Display position X		
1619	Overlap 4 Display position Y		
1620	Overlap 4 Overlap library number		
1621	Overlap 5 Registration/display status		
1622	Overlap 5 Display position X		
1623	Overlap 5 Display position Y		
1624	Overlap 5 Overlap library number		
1625	Overlap 6 Registration/display status		
1626	Overlap 6 Display position X		
1627	Overlap 6 Display position Y		
1628	Overlap 6 Overlap library number		
1629	Overlap 7 Registration/display status		
1630	Overlap 7 Display position X		
1631	Overlap 7 Display position Y		
1632	Overlap 7 Overlap library number		
1633	Overlap 8 Registration/display status		
1634	Overlap 8 Display position X		
1635	Overlap 8 Display position Y		
1636	Overlap 8 Overlap library number		
1637	Overlap 9 Registration/display status		
1638	Overlap 9 Display position X		
1639	Overlap 9 Display position Y		
1640	Overlap 9 Overlap library number		
1641	Screen magnification Stores the current magnification of the screen (unit: %). 100 (includes case when no magnification is set), 150, 200	← V	V9 Series Reference Manual 2 "7.1 Enlarging and Scrolling Screens"
⋮	(Blank)		
1650	Scheduler Time setting (device memory specification) error flag (No. 0 to 15) Correct: 0, Incorrect: 1	← V	V9 Series Reference Manual 2 "3 Scheduler"
1651	Scheduler Time setting (device memory specification) error flag (No. 16 to 31) Correct: 0, Incorrect: 1		
1652	Scheduler Time setting (device memory specification) error flag (No. 32 to 47) Correct: 0, Incorrect: 1		
1653	Scheduler Time setting (device memory specification) error flag (No. 48 to 63) Correct: 0, Incorrect: 1		
⋮	(Blank)		
1656	STA_LIST macro command Specification of data sheet output destination and PDF filename time stamp	→ V	<a href="#">page 1-50</a>
⋮	(Blank)		

\$s	Description	Device Type	Refer to
1671	Operation designation with the following macro commands SMPL_BAK, SMPL_CSV, SMPL_CSV2, SMPLCSV_BAK, SMPLCSV_BAK2, SYS(SET_BUFNO), SYS(GET_SMPL) 0: V8 compatible operation 1: Logging server designation 2: Alarm server designation		
1672	SYS(GET_SMPL) macro command Obtained alarm data type designation (only when \$s1671 = 2) 0: Event history data 1: Real time alarm data 2: Alarm history data	→ V	V9 Series Macro Reference Manual
1673	SAMPLE, SMPL_SAVE macro commands Operation designation 0: V8 compatible operation 1: V9 initial operation		
1674	VNC server state (SYSTEM PROGRAM Ver. 1.050 or higher) 0: Not connected, 1: Connected	← V	V9 Series Reference Manual 2 6.10 VNC Server
⋮	(Blank)		
1690	Data transfer service Confirmation of FTP communication status 0: No communicating 1: Uploading 2: Downloading		
1691	Data transfer service Record number in execution (only when \$s1690 = 1 or 2)	← V	V9 Series Reference Manual 2 6.11 Data Transfer Service
1692	Data transfer service Server table number in execution (only when \$s1690 = 1 or 2)		
⋮	(Blank)		
1705	SYS(SET_BUFNO) macro command Storage of logging block number (only when \$s1671 = 1) Stores the logging block number specified by the macro. Default value: -1	← V	V9 Series Macro Reference Manual
1706	SYS(SET_BUFNO) macro command Storage of alarm block number (only when \$s1671 = 2) Stores the alarm block number specified by the macro.	← V	V9 Series Macro Reference Manual
⋮	(Blank)		
2047			



## Details

- \$s2 - 13, \$s1617 - 1640  
Stores the current overlap display status.

n + 0 (Display status)

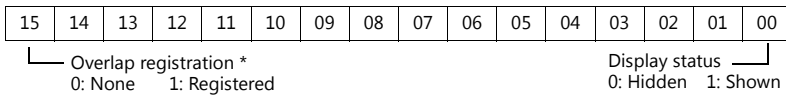

- \* For multi-overlap display, this bit is set to "1" only during display.  
However, the bit remains set to "1" even during display hidden status when [Read PLC Device when OFF] is checked in the [Detail] settings of overlap library settings.

n + 1 (X coordinate)

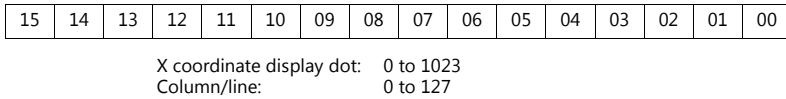

n + 2 (Y coordinate)

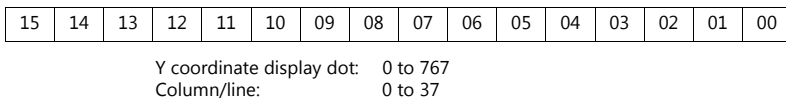

n + 3 (Multi-overlap number)

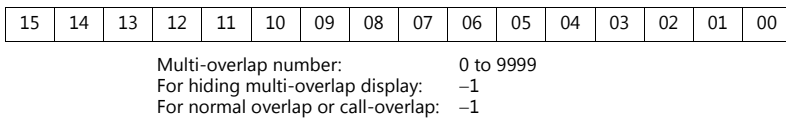

- \$s16  
Stores the current printer status.

n + 0 (Printer status)

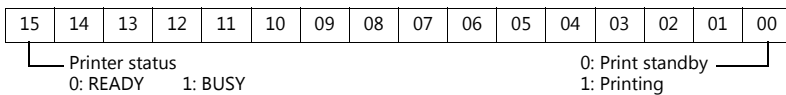

- \$s17  
Stores the current backlight status. Whether the backlight is burnt out is stored.

n + 0 (Backlight status)

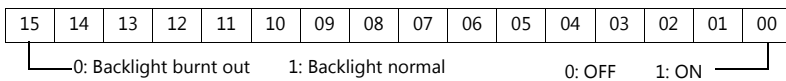

- \$s20 to 55 (V7 compatible)  
Stores sampling buffer conditions.

Buffer No. 0 to 11	n + 0	[No. of Samples] specified in the [Buffering Area Setting] window
	n + 1	Number of sampling times in buffer (n + 0 ≥ n + 1)
	n + 2	Number of sampling times executed

- \$s66  
Repeat the switch ON macro. Set a number other than "0" to \$s66 using the ON macro.  
Example: Set the switch ON macro as shown below.

```
$u100 = $u100 + 1
$s66 = 1
RET
```

While the switch is held down, \$u100 is continuously incremented.

- \*1 Before executing the switch ON macro, the system clears addresses \$s64 to 66 to "0".

Set "1" to these addresses as necessary.

When a macro is repeatedly commanded to repeatedly execute the function of switch, the macro will be prohibited if the function cannot be executed. (For example, when the switch function is [+ Block] and the block number has reached the maximum value.)

- \$s75

This address is used to activate or deactivate the buzzer which sounds when the top overlap display among multiple overlap displays is switched over. For an overlap display with [Superimpose] selected, the buzzer is inactive regardless of the setting of \$s75.

[0]: Buzzer ON

[1]: Buzzer OFF

- \$s78

Stores the display format of data in the entry target.

Output Code	Entry Target	Display Format
-2	No entry mode	-
-1	No entry target	-
0	Numerical data display	Decimal without sign
1		Decimal with sign (-)
2		Decimal with sign (+)
3		Hexadecimal
4		Octal
5		Binary
6	Character display	-
7	Message display other than entry target	-
8	Numerical data display	Real number (floating decimal point)

- \$s79

This setting is available when the entry mode is switched through the overlap activation (ON/OFF) or by multi-overlap number change on one screen.

\*1 Do not set any value other than "0" or "1".

[0]: Selects the last entry target selected in the entry mode.

[1]: The entry target currently selected remains selected even after the mode is switched.

- \$s99

Specify the rounding operation to use with the CVFD macro command.

Setting Value	Description	Operations
Other than 1 or 2	Rounding	When the fraction remainder is 0.5 or greater, it is rounded up; when it is less than 0.5, it is rounded down.
1	Rounding down	The fraction remainder is rounded down.
2	Rounding up	The fraction remainder is rounded up unless it is "0".

- \$s104 and \$s105

Specify the error handling performed when an error occurs during the reading/writing of data to the PLC using a macro command via communications.

Example:

When an indirect PLC device memory is set as the writing destination using the MOV command, a communication error will occur if the value in the indirect PLC device memory exceeds the range of the PLC device memory.

Use these addresses to avoid such a communication error.

- \$s104: [0]

When the write macro command is executed, the next command is started without waiting for the result of the macro write command.

If an error occurs during writing, error handling is performed.

The error handling to be performed depends on the setting for [Comm. Error Handling] ("Stop" or "Continue") under [Communication Setting] in the [PLC Properties] window.

- \$s104: Other than [0]

When the write macro command is executed, the next command is started only after receipt of the result of the write operation. If an error occurs during writing, error handling is not performed and the result is stored in \$s105. It will take a longer time compared to when "0" is set.

\$s105: When \$s104 ≠ 0, the result of the macro write error is stored.

[0]: Normal

Other than [0]: Error

- **§s107**

The information of whether or not data is registered in each page of the memo pad (maximum 8 pages) is stored.

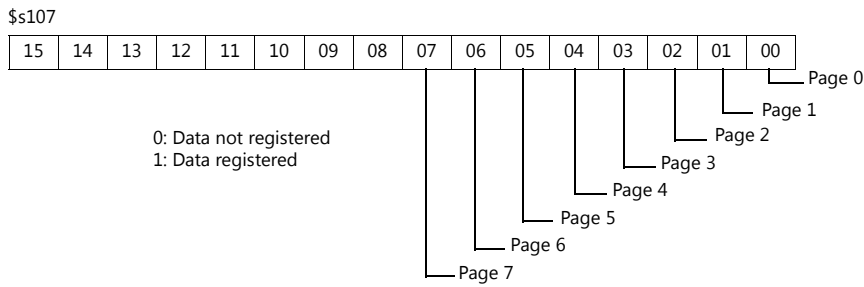

- **§s128, 129, 114 to 127 (V7 compatible)**

When the connection mode is [1 : n] and a timeout is detected in communication with PLC1, "1" is set at the related bit. After that, it is not possible to communicate with the PLC on the same screen.

When the screen display changes, all bits in these device memory are cleared to "0" to enable communication with the PLC set to the screen program.

§s128

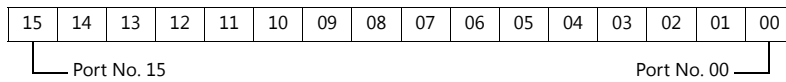

§s129

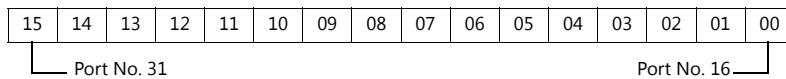

§s114

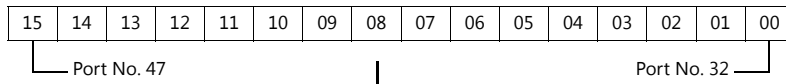

§s127

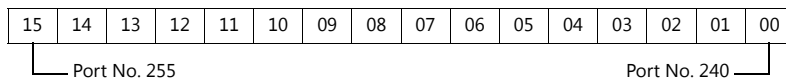

- **§s160 - 166**

Stores the calendar data that is read from the PLC or is currently displayed on MONITOUCH at the start of communication.

- **§s178, 179**

When the total value overflows after the execution of the SET\_BUFNO macro command, the bits corresponding to sample word numbers 0 to 31 are set to "1".

Sample buffer word numbers 32 to 128 are not available.

§s178

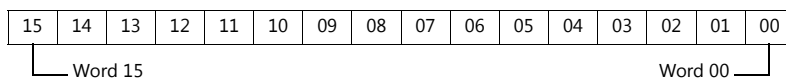

§s179

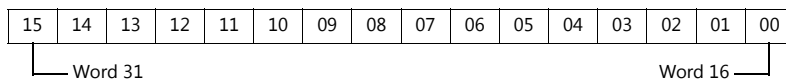

- **§s177**

Stores the buffer number for which the SET\_BUFNO macro command was executed. When the power is turned on, the lowest buffer number in the [Buffering Area Setting] window is stored.

- **§s180 - 435**

Stores the result of the SET\_BUFNO macro command execution.

- \$s497

Outputs the result of accessing the storage device.

4	Card not mounted
6	Card size too small
7	Different card type
9	JPEG/BMP file read error
12	Card write error
15	Disk error (open failure)
16	Card read error

- \$s514, 515

These devices are relevant to the EREAD, EWRITE, SEND, and MES macro commands.

- \$s514: Macro wait request

In the case of successive accesses to the same port on a single macro sheet, always specify a value other than "0" (with wait). If "0" (no wait) is specified, macro commands issued afterward will not be accepted.

[0]: No wait

During the execution of a macro command, the execution of the next macro command takes place before the completion of the current command.

[Other than 0]: With wait\_

During the execution of a macro command, the next macro command is put on hold and is executed after the completion of the current command.

- \$s515: Storage of the macro execution result

When \$s514 is "0", the macro command request is stored (response not included). When a value other than "0" is set, the response returned to the command request is stored.

Code	Description	Solution
0	Normal	-
200 to 2000	Communication error	For details, refer to \$s518 in V9 Series Connection Manual 1.
-30	Timeout	Check whether an error has occurred on the destination V9 series unit.
-31	Number of words for sending exceeded	Use the macro editor to check the number of words for sending.
-32	The specified table is not used.	Check the network table settings.
-33	The send command cannot be used.	Use the macro editor to check the macro command.
-34	The specified table is in use.	Check whether system device memory address \$s514 is set. If not setting \$s514, reduce the number of communications.
-35	Processing impossible due to insufficient memory	Check the memory availability of the counterpart device.
-36	Incorrect number of receive packet bytes	Check the number of request words.
-37	Local station memory access error	Check the request memory settings.
-38	Macro setting error	Check the macro settings.
-39	Cannot process command on the destination V9 series unit (local mode, communication error)	Restore the destination V9 series unit to RUN mode and execute the macro command again.

- \$s814 - 818

Stores the IP address of the network table number corresponding to the value\* set for \$s818. If no network table exists, "0.0.0.0" is stored.

\*1 Use the MOV (W) macro command to set the network table number.

- \$s1030

Outputs the result of access to the storage device at the built-in socket (drive: C).

4	Card not mounted
6	Card size too small
7	Different card type
9	JPEG/BMP file read error
12	Card write error
15	Disk error (open failure)
16	Card read error

- **\$s1035**  
Outputs the result of access to the storage device at USB-A (drive: D). Same details as \$s1030.
- **\$s1050**  
Outputs the status of the operation related to the storage device.

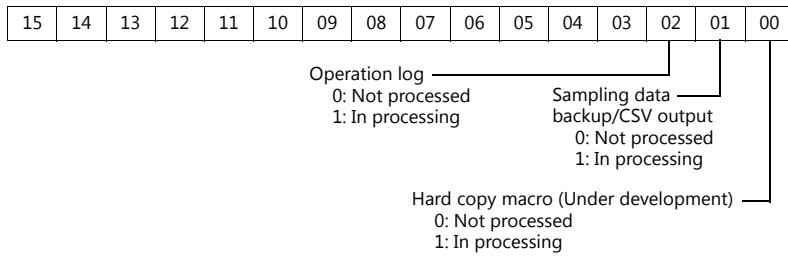

- **\$s1051**  
Outputs the status of the completed operation related to the storage device.

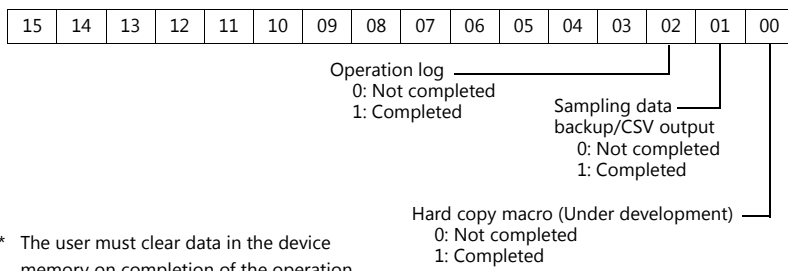

\* The user must clear data in the device memory on completion of the operation.

- **\$s1052**  
If an error occurs on completion of processing related to the storage device, the result is output.

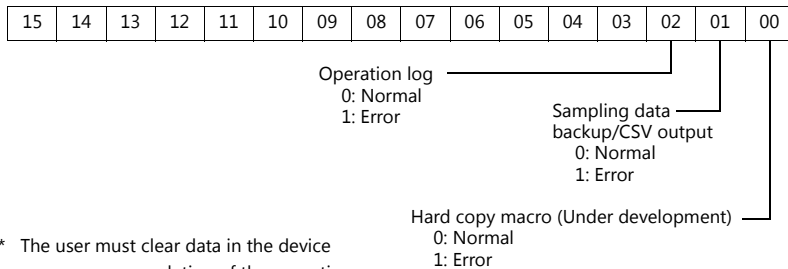

\* The user must clear data in the device memory on completion of the operation.

- **\$s1066**  
Outputs the status of printing performed on the PictBridge printer.

Value	Description	Cause and Remedy
0	The PictBridge printer is not connected or it is in the normal state.	-
1	Printing in progress using the PictBridge printer.	-
-1	Printer error (hardware related)	The cable is not connected. Check the USB cable connection. Check if the printer is out of order.
-2	Printer error (paper related)	The printer ran out of paper. Add paper. The type of paper is not correct. Set the correct type of paper.
-3	Printer error (related to ink) *	The ink is not installed. Install an ink cartridge. The ink level is low. Install a new ink cartridge.

- \$s1085  
Stores information regarding forced formatting of the SRAM area.  
This is available when the [Format the SRAM forcefully] checkbox is selected in the [General Settings] window.  
[0]: Forced formatting not executed.  
[1]: Forced formatting executed (cleared to "0" when the mode changes from RUN to STOP).
- \$s1098  
Other than [0]:  
Executes background processing of the "SMPL\_BAK", "SMPL\_CSV", and "SMPL\_CSV\_BAK" macro commands. However, if background processing is being executed to the buffer that has been specified, the next processing is started on completion of the current macro processing.
- \$s1108  
The media status at the secondary storage destination, sampling formatting condition, etc. are comprehensively judged and the valid/invalid state of the secondary storage destination is output.  
[0]: Writing or browsing the secondary storage destination is not possible.  
[1]: Writing or browsing the secondary storage destination is possible.
- \$s1109  
Outputs the status of creating a backup file or CSV output.  
Other than [0]: Backup file being created or CSV file outputted
- \$s1110  
Outputs the status of sampling macro commands.  
Other than [0]: Execution of the "SMPL\_BAK", "SMPL\_CSV", or "SMPL\_CSV\_BAK" macro command is in progress.
- \$s1111  
Outputs the status of sampling macro commands.  
Other than [0]: Execution of the "SMPL\_BAK", "SMPL\_CSV", or "SMPL\_CSV\_BAK" macro command is complete.  
\*1 This is cleared when \$s1110 (executing flag) is set to ON.
- \$s1112  
Outputs the status of sampling macro commands.  
Other than [0]: Execution error of the "SMPL\_BAK", "SMPL\_CSV", or "SMPL\_CSV\_BAK" macro command  
\*1 This is cleared when \$s1110 (executing flag) is set to ON.
- \$s1113  
Outputs the sampling status.  
Other than [0]: A communication error occurred during sampling.  
\*1 This is cleared when sampling is performed normally. Sampling information of device tables is not output.
- \$s1114  
Outputs the sampling status.  
Other than [0]: If a communication error occurs during sampling, sampling will continue by resetting the data to "0" in the device memory where the error occurred.  
\*1 Sampling of device tables is performed regardless of the setting of this flag, with the data regarded as "0" in the device memory where an error occurred.
- \$s1560  
Stores the global overlap display status.

n + 0 (Display status)

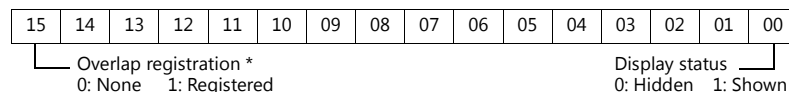

- \* This bit is set to "1" only during display.  
However, the bit remains set to "1" even the display hidden status when [Read PLC Device when OFF] is checked in the [Detail] settings of overlap library settings.

- \$s1656  
Selects the data sheet output destination and whether a time stamp is added to filenames using bit statuses.  
This setting is available when using the STA\_LIST macro.

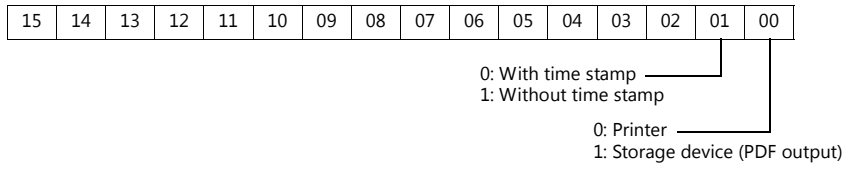

## **2 Overlap**

---

- 2.1 Overview
- 2.2 Normal Overlap
- 2.3 Call-overlap
- 2.4 Multi-overlap
- 2.5 Global Overlap
- 2.6 Display Transparency



## 2.1 Overview

### 2.1.1 Overlap Displays

Windows can be displayed on the screen. These overlaying windows are called "overlap" displays.

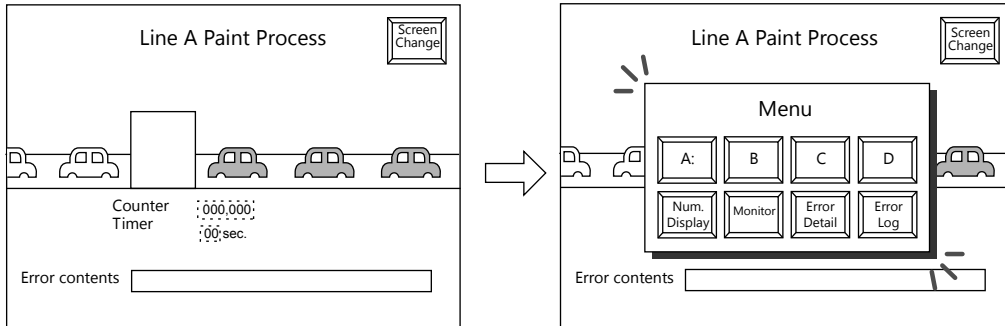

Each screen has an overlap display area ID from 0 to 9, and 10 overlaps can be displayed at once.

\* Overlap ID: An ID that identifies an overlap display on the screen.

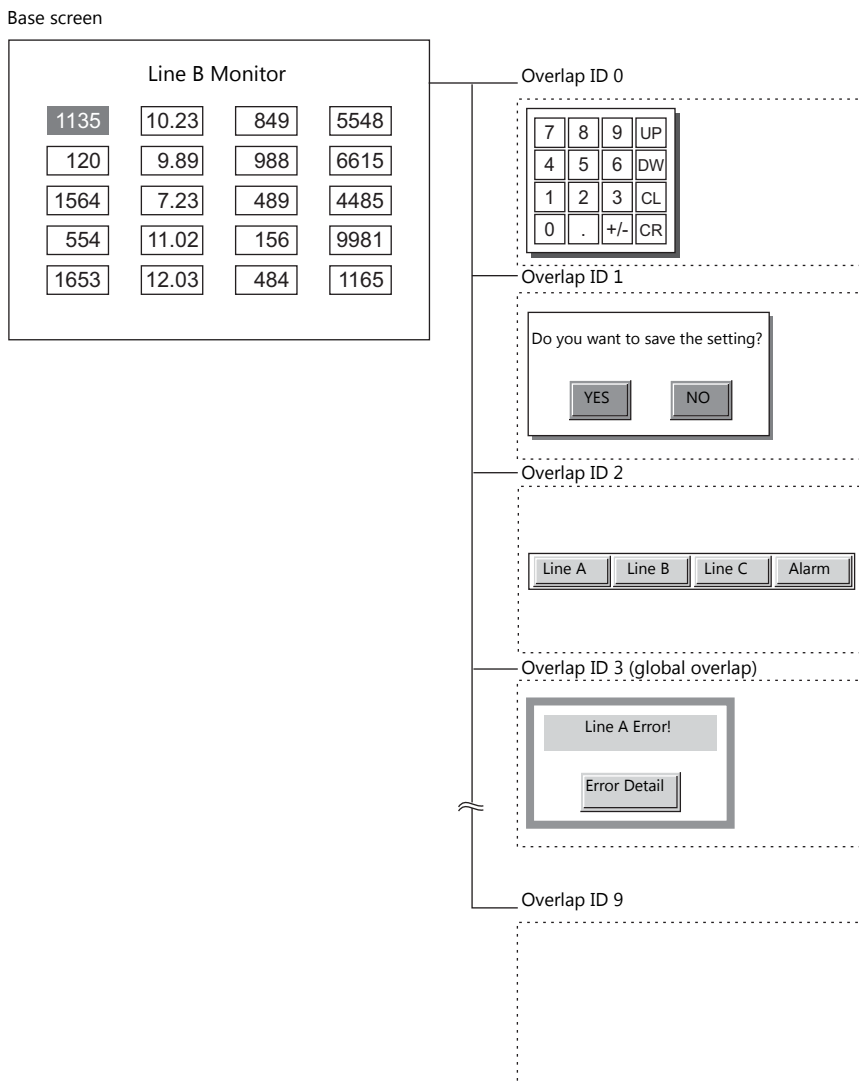

When several overlap displays are shown at the same time, it is possible to move an overlap display that is partly behind another to the foreground by touching the screen.

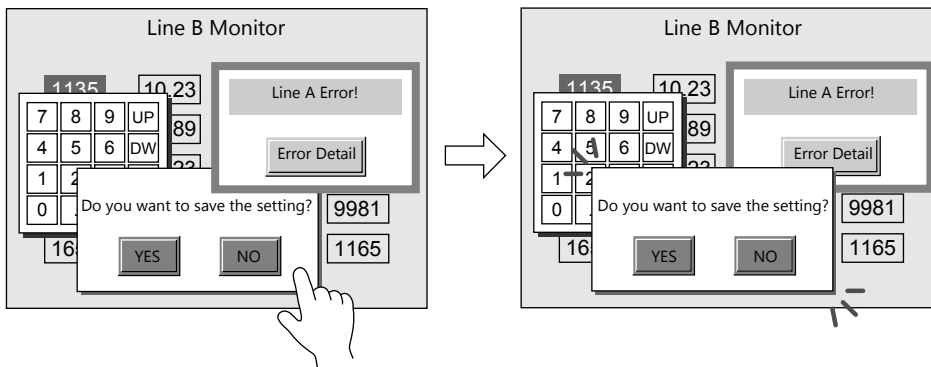

\* However, when a value other than "0" is entered for system device memory \$s77, only the switches (including system buttons) on the overlap display in the foreground are available (exclusive function).

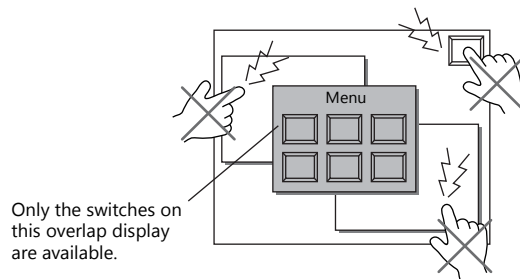

☞ "1.3 List of Internal Device Memory"

• Scrolling function

Overlap displays up to four times larger than the normal overlap display size can be registered. When an overlap display is partially off-screen, the overlap display can be scrolled to display the off-screen content.

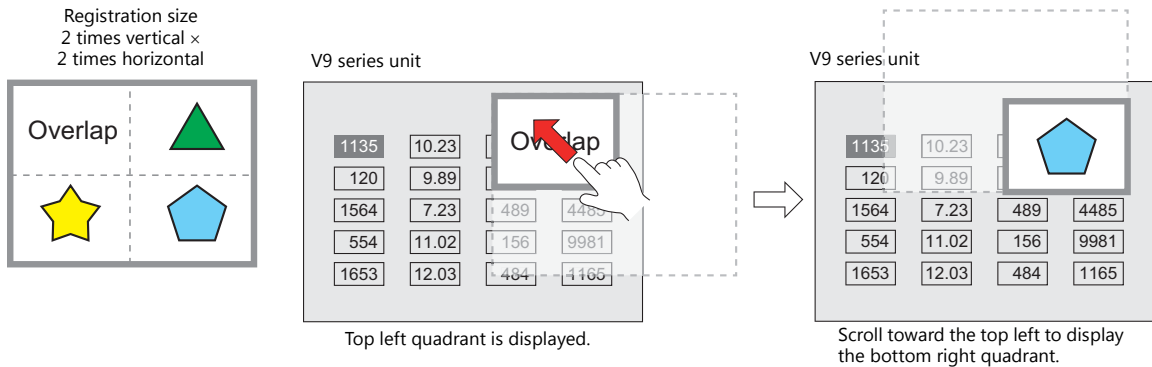

☞ "Scroll" page 2-10

• Transition function

Slide and fade effects can be added when displaying overlap displays using a switch function.

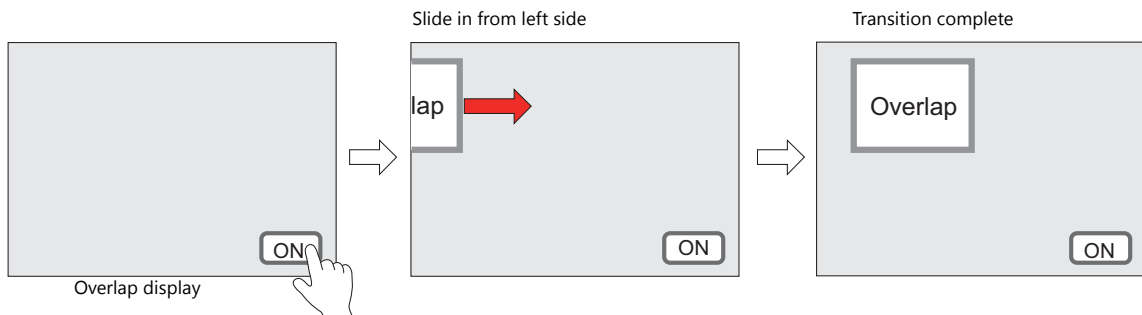

☞ "Transition" page 3-11

## 2.1.2 Overlap Display Formats

Overlap displays comprise the following four formats.

Overlap	Refer to
Normal overlap	<a href="#">page 2-3, page 2-8</a>
Call-overlap	<a href="#">page 2-4, page 2-14</a>
Multi-overlap	<a href="#">page 2-5, page 2-17</a>
Global overlap	<a href="#">page 2-6, page 2-23</a>

### Normal Overlap

This overlap display format is unique to each screen.

An overlap display created for screen 1 cannot be displayed on other screens.

A normal overlap display can be shown or hidden using a switch or command from the PLC.

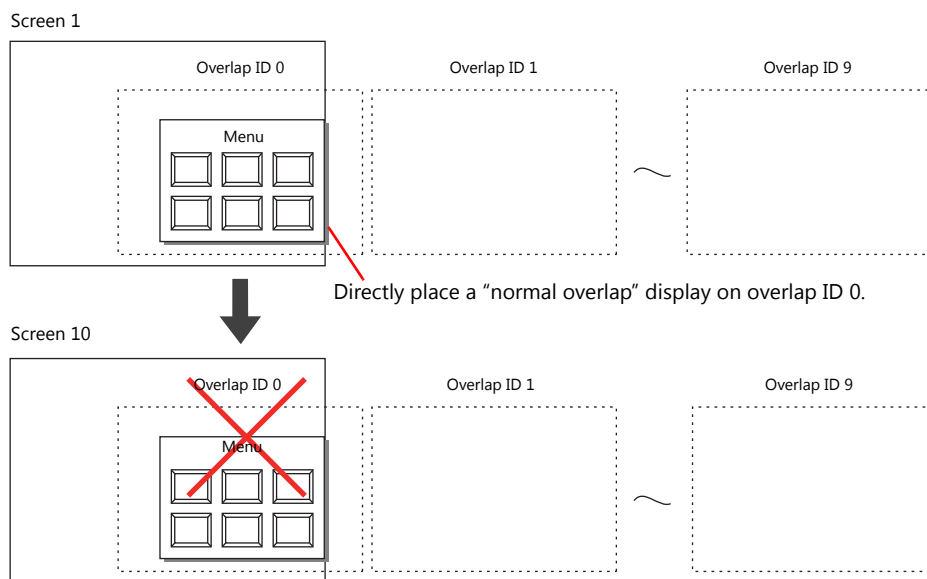

# Call-overlap

This overlap display format calls and displays overlaps registered to the overlap library. Because overlap displays are called from the library, they can be shared between multiple screens.

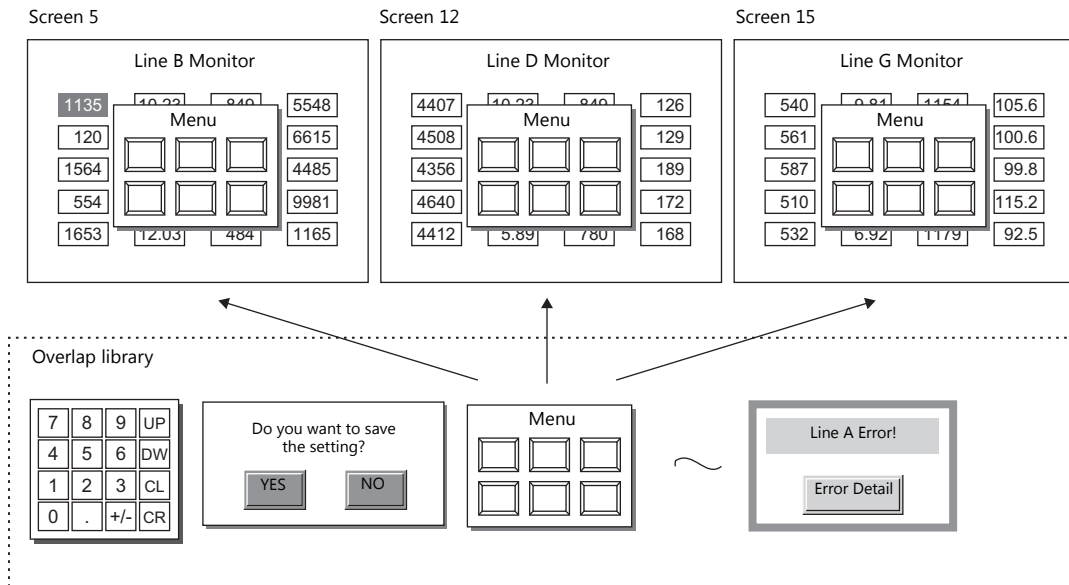

An overlap library number is set with respect to the overlap IDs from 0 to 9 on each screen. A maximum of ten overlaps can be displayed at once. A call-overlap display can be shown or hidden using a switch or command from the PLC.

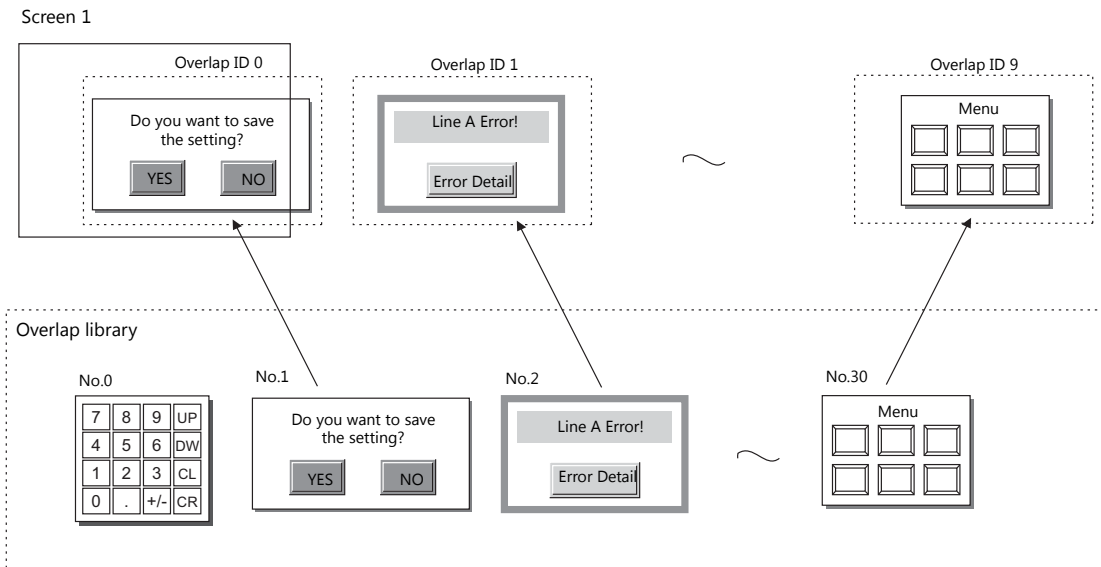

# Multi-overlap

This overlap display format calls and displays overlaps registered to the overlap library. Because overlap displays are called from the library, they can be shared between multiple screens.

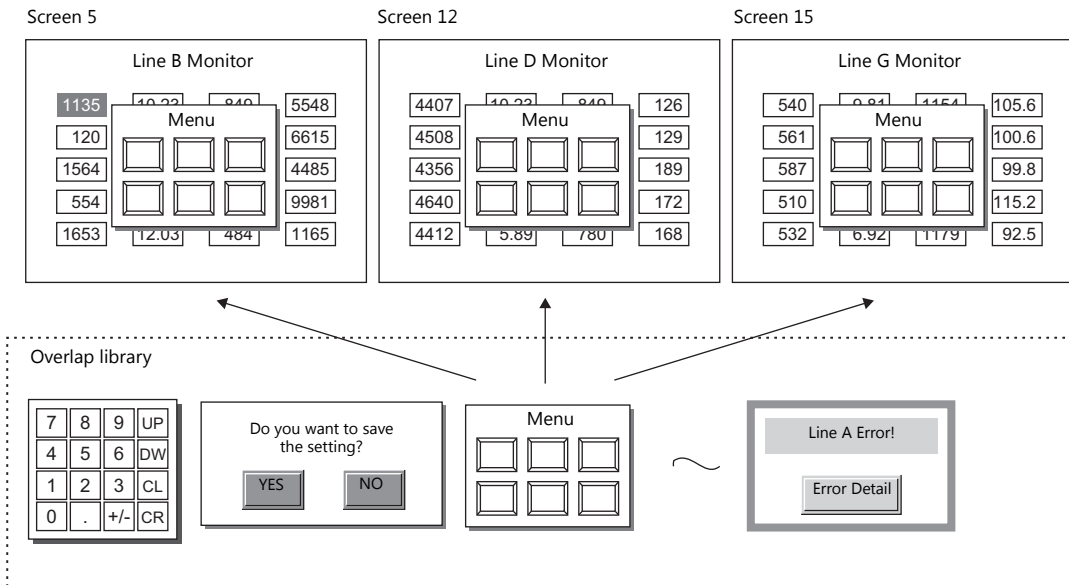

An overlap library number that can be switched between 0 and 9999 can be set with respect to a single overlap ID. A maximum of 10 overlaps can be displayed at once and 4000 types of overlaps can be selected by switching the overlap library number. A multi-overlap display can be shown or hidden using a switch or command from the PLC.

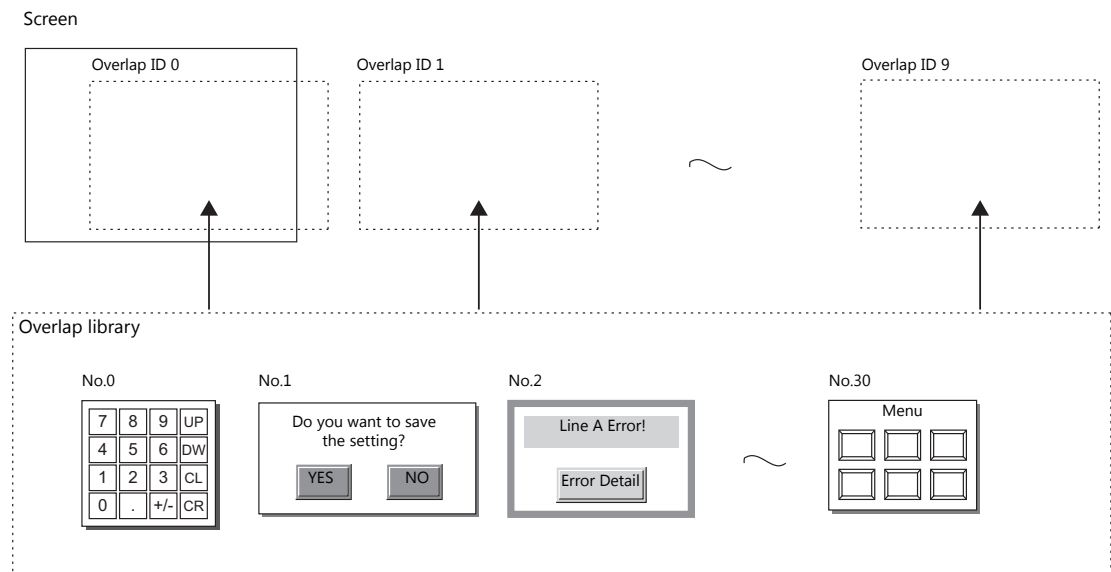

# Global Overlap

This overlap display format calls and displays overlaps registered to the overlap library. Because overlap displays are called from the library, they can be shared between multiple screens. An overlap library number that can be switched between 0 and 9999 can be set with respect to a single overlap ID. A maximum of 10 overlaps can be displayed at once and 4000 types of overlaps can be selected by switching the overlap library number. A global overlap display can be shown or hidden using a switch or command from the PLC.

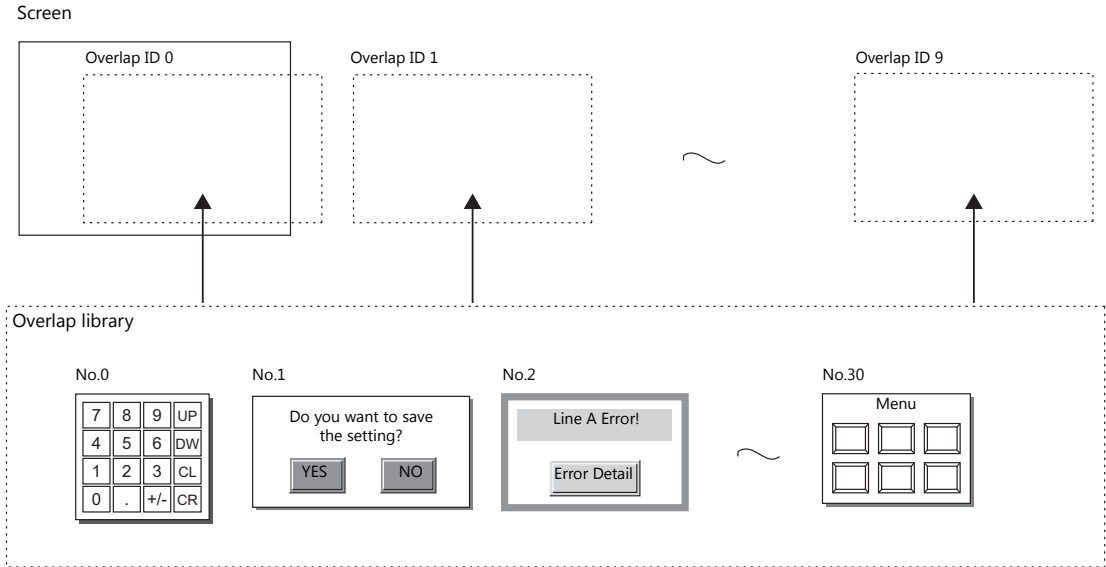

The same overlap display is shown even if the screen changes to another screen. Because this overlap format is not affected by screen changes, it is well suited to high-urgency alarm displays.

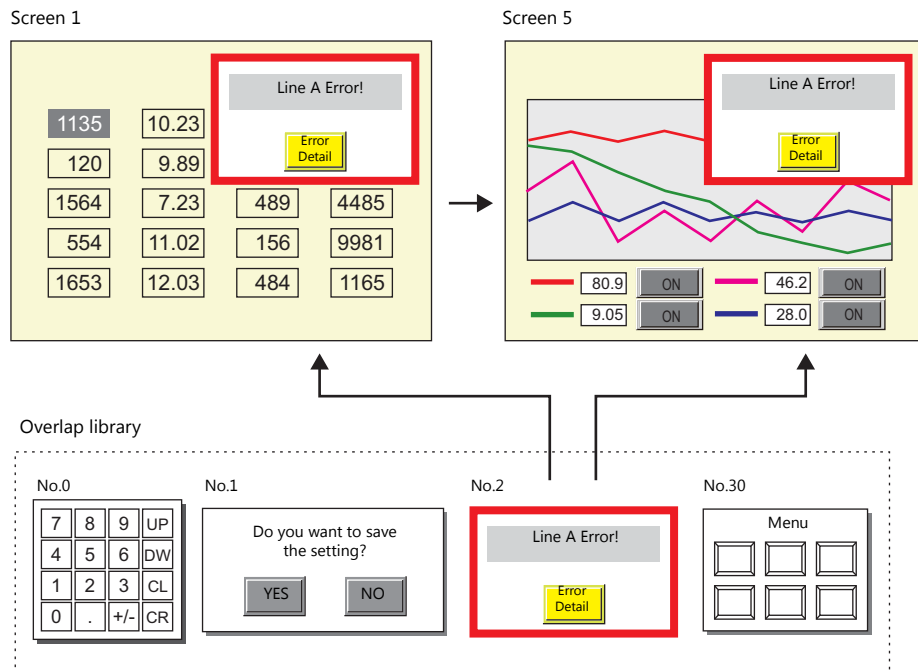

## 2.1.3 Overlap Auxiliary Functions

### System Buttons

The system button overlap auxiliary function operates in the following two ways.

#### Overlap Movement

Touch the top left corner (2 x 2 switch grid) of the overlap display to make the overlap frame blink.

With the overlap frame blinking, touch a position on the screen once to move the overlap display to that position. (The frame stops blinking after the overlap display is moved.)

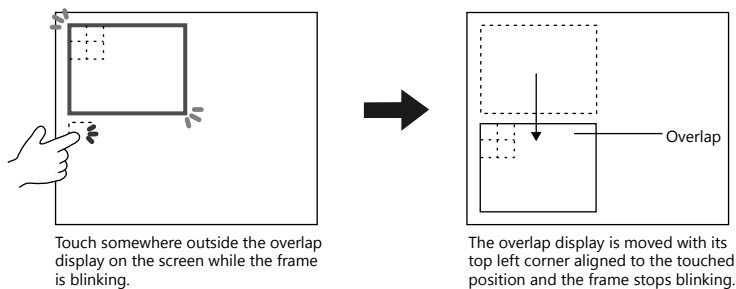

If the overlap display will protrude off-screen at the new position, the protrusion is automatically adjusted so that the entire overlap display is shown on-screen.

To stop the overlap frame blinking (and cancel the movable state), touch the top left corner of the overlap display again.

#### Hiding the Overlap Display

Double-touch (touch the screen twice within one second) the top left corner (2 x 2 switch grid) to hide the overlap display.

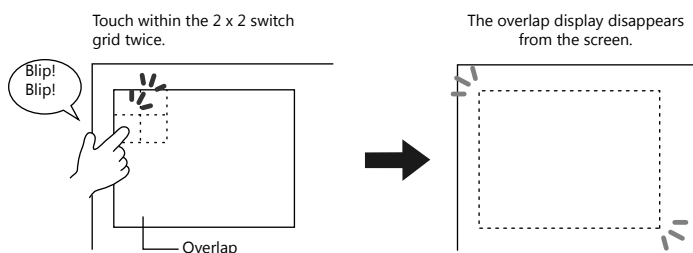

#### Setting system buttons

The system button can be set in the [Detail] setting of the setting window for each overlap.

 ["Detail" page 2-10](#)

### Display Transparency

When an overlap is displayed, it blocks the display of anything behind it. By using transparency, an overlap can be displayed while retaining the ability to check information behind it.

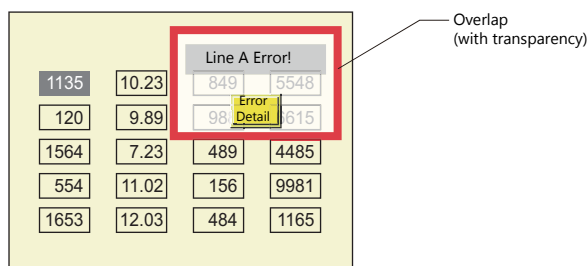

 ["2.6 Display Transparency"](#)

## 2.2 Normal Overlap

### 2.2.1 Creation Procedure

Use the following procedure to create a normal overlap.

1. Click [Parts] → [Overlap] → [Normal Overlap] and place an overlap.

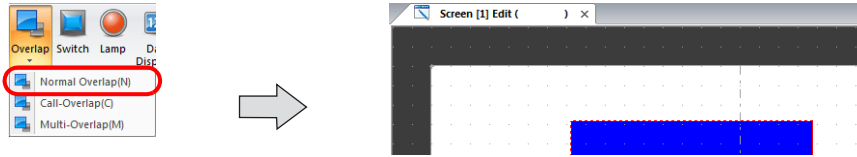

2. Adjust the size of the overlap.
3. Select [Overlap Editing] → [ID 0] on the right-click menu. The overlap editing window is displayed.

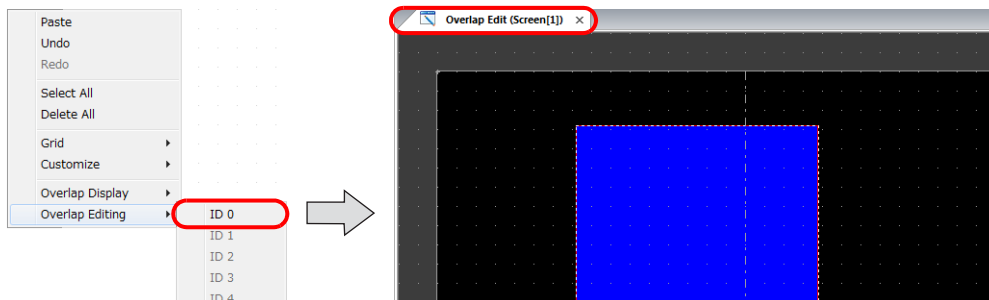

4. Place switches, lamps, and other items on the overlap.
5. Select [Overlap Editing] → [ID 0] on the right-click menu. The user is returned to the screen editing window.

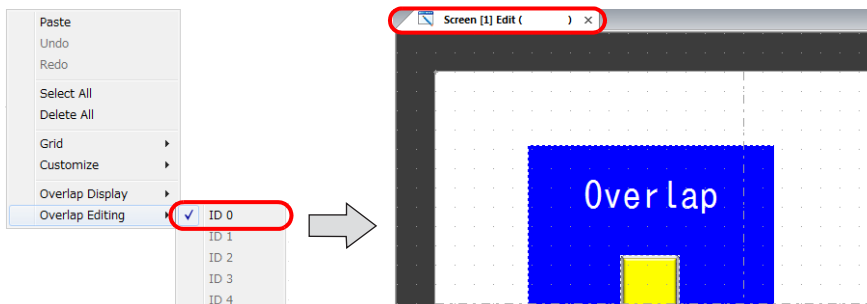

6. If performing showing/hiding with a switch, place a switch. [page 2-11](#)

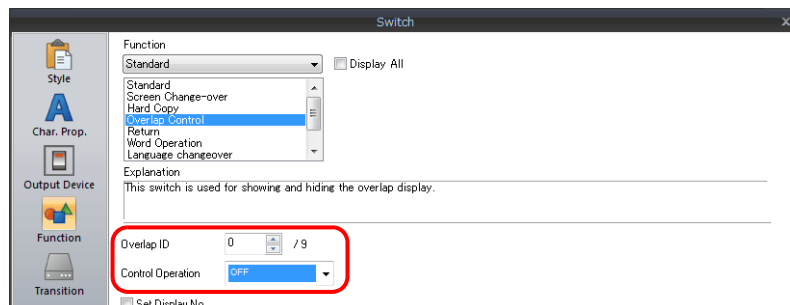

7. If performing showing/hiding with commands from a PLC, configure the [Control Device] settings. [page 2-13](#)

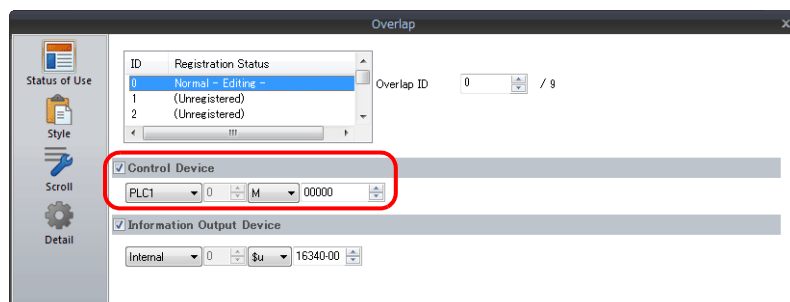



## 2.2.2 Detailed Settings

### Status of Use

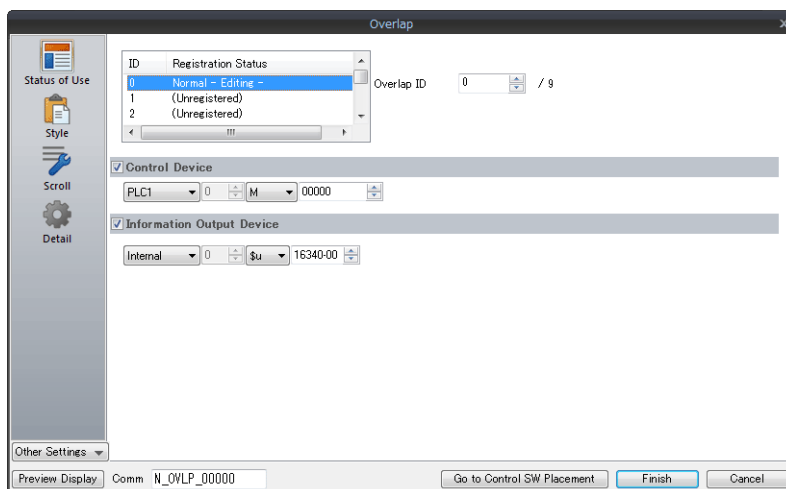

Item	Description
Registration Status	Check the registration status of overlap IDs 0 to 9. "- Editing -" is shown for the ID that is currently being edited. The overlap ID can also be changed to an unregistered ID.
Control Device	Specify a device using one bit. Showing and hiding is performed according to the value of the least significant bit. 0 → 1: Show 1 → 0: Hide * Select the [Display Overlap during bit ON] checkbox at [System Setting] → [Unit Setting] → [General Setting] to allow level operation. Refer to <a href="#">page 2-13</a> .
Information Output Device	Specify a device using one bit. Stores the overlap display status. 0: Hide 1: Shown

### Style

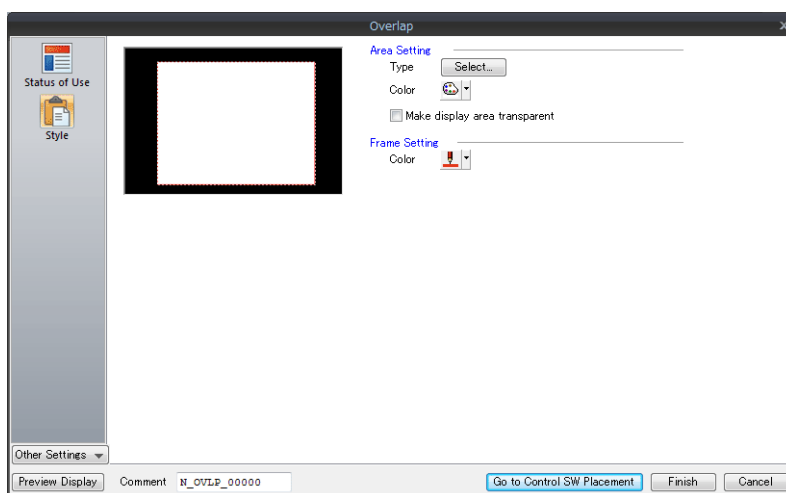

Item	Description
Area Setting	Set the design and color of the area.
Frame	
Make display area transparent	Make the overlap area transparent. Only the items placed on the overlap are displayed on the V9 series unit. The transparency of placed items can be set via [Detail] → [Transparency Display].

Refer to the V9 Series Operation Manual.



## Scroll

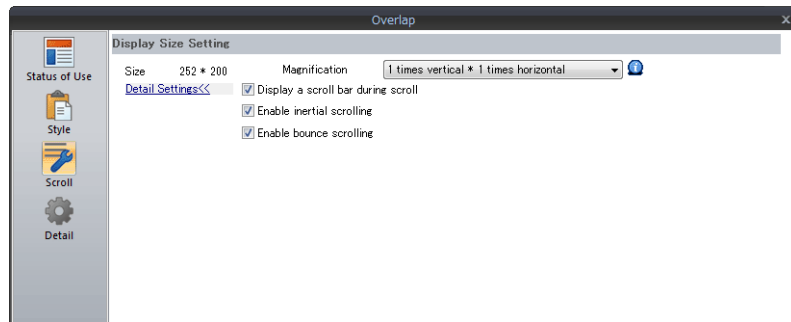

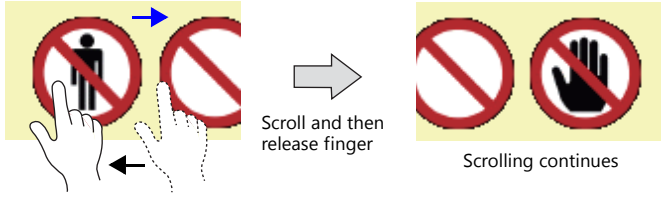
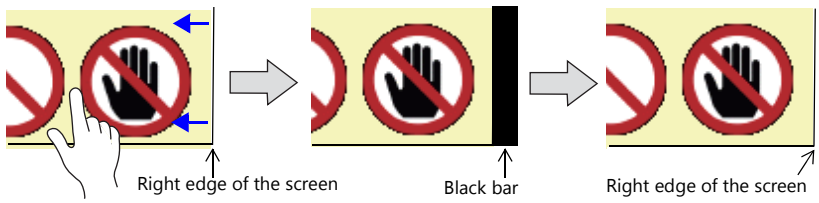
Item	Description	
Display Size Setting	Use [Magnification] to set the editing size of the overlap. 1 times vertical × 1 times horizontal / 1 times vertical × 2 times horizontal / 1 times vertical × 3 times horizontal / 1 times vertical × 4 times horizontal / 2 times vertical × 1 times horizontal / 2 times vertical × 2 times horizontal / 3 times vertical × 1 times horizontal / 4 times vertical × 1 times horizontal	
Detail Settings	Display a scroll bar during scroll	Display a scroll bar at the right edge and bottom when scrolling. The scroll bar itself cannot be operated.
	Enable inertial scrolling	Allow scrolling to continue after releasing your finger from the screen when scrolling. The speed of scrolling gradually decreases until it stops.  
	Enable bounce scrolling	Scrolling will bounce to indicate that movement in the particular direction has reached its limit. A black frame is displayed momentarily.  

 Refer to "7.1 Enlarging and Scrolling Screens" in the V9 Series Reference Manual 2.

## Detail

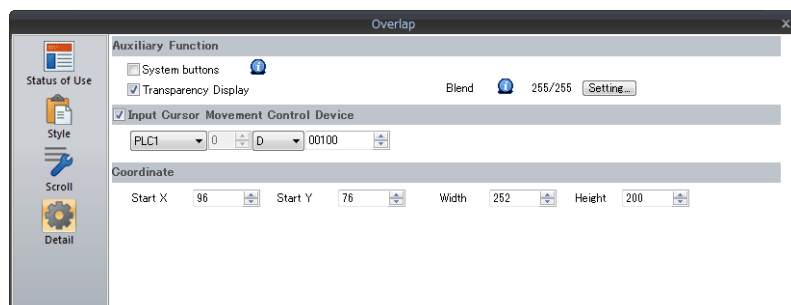

Item	Description	
Auxiliary Function	System buttons	Select this checkbox to use system buttons. Refer to <a href="#">page 2-7</a> .
	Transparency Display	Select this checkbox to enable transparency. Refer to <a href="#">page 2-29</a> .
Input Cursor Movement Control Device	This setting is required to use the "entry function" on an overlap display. For details, refer to <a href="#">page 6-33</a> .	
Coordinate	Start X/Start Y	Set the display position of the overlap using X and Y coordinates.
	Width/Height	Set the size of the overlap.

## 2.2.3 Show/Hide Settings

There are three methods for showing and hiding normal overlap displays.

Method		Error Detail	Refer to
Internal command	Switch	Function: Overlap Control Set Display No.: Unselected	<a href="#">page 2-11</a>
	Macro	OVL_P_SHOW OVL_P_POS	<a href="#">page 2-12</a>
External Command	Control device memory	0 → 1: Show 1 → 0: Hide	<a href="#">page 2-13</a>

### Switch

#### Setting

1. Display the settings menu of the normal overlap display.
2. Click [Go to Control SW Placement] and place a switch.

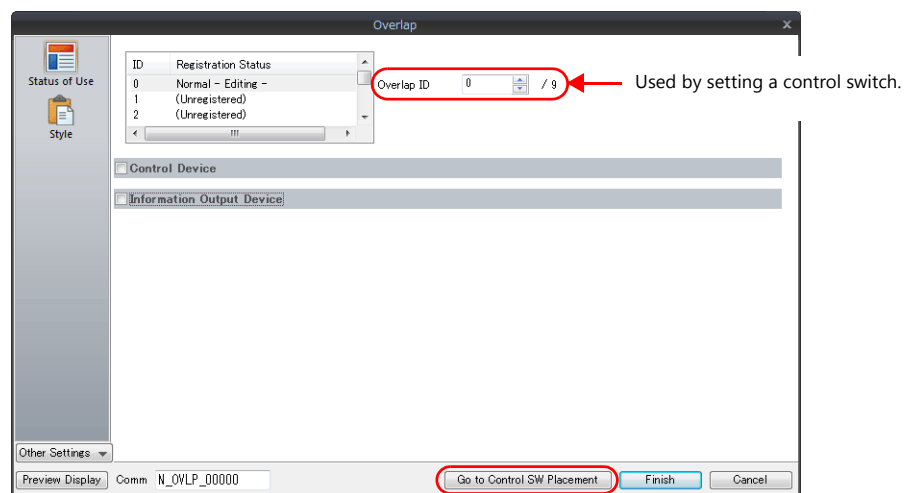

3. Set the function of the switch.

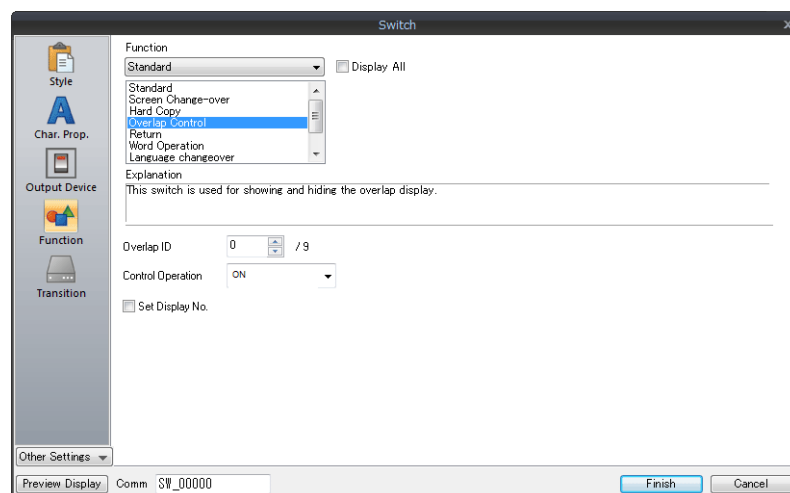

Function	Overlap Control
Overlap ID	Specify the same ID as the [Overlap ID] of the normal overlap.
Control Operation	ON: Show OFF: Hide ALT: Alternate between show and hide ICON: Show
Set Display No.	Unselected

## Macro

---

A macro can be used to show and hide normal overlap displays. In this case, use the "OVLP\_SHOW" command. The "OVLP\_POS" command is used to specify the display position. For details, refer to the V9 Series Macro Reference Manual.

## Setting

1. Creating a macro for showing an overlap display

- 1) Display the [Macro Block No. Editor] window.
- 2) Register the following macro.

\$u100 = 2 (W)	Set an overlap ID from 0 to 9 (ID2 in this example).
\$u101 = 1 (W)	Overlap display
SYS (OVLP_SHOW) \$u100	Execute the command.

- 3) Execute the macro block in a switch ON macro or global macro.

2. Creating a macro for hiding an overlap display

- 1) Display the [Macro Block No. Editor] window.
- 2) Register the following macro.

\$u100 = 2 (W)	Set an overlap ID from 0 to 9 (ID2 in this example).
\$u101 = 0 (W)	Hide the overlap display
SYS (OVLP_SHOW) \$u100	Execute the command.

- 3) Execute the macro block in a switch ON macro or global macro.

## Control Device Memory

### Setting

- In the normal overlap settings menu, click [Status of Use] and configure the [Control Device] settings.

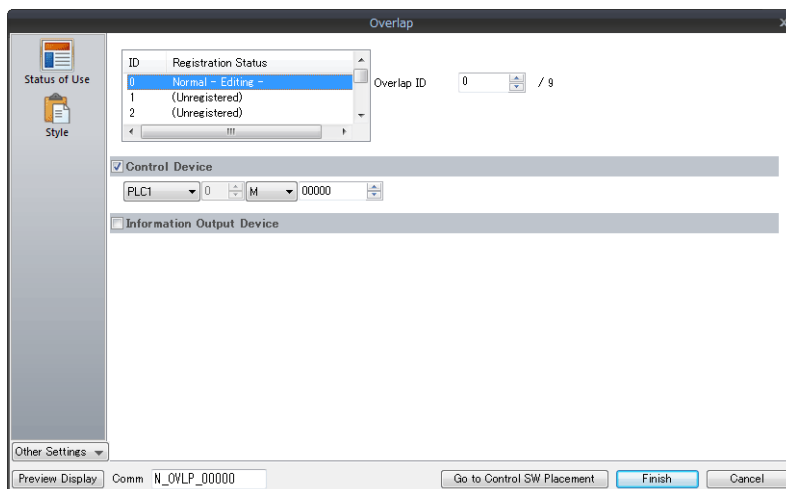

- The overlap is shown when the [Control Device] bit is ON and hidden when the bit is OFF.

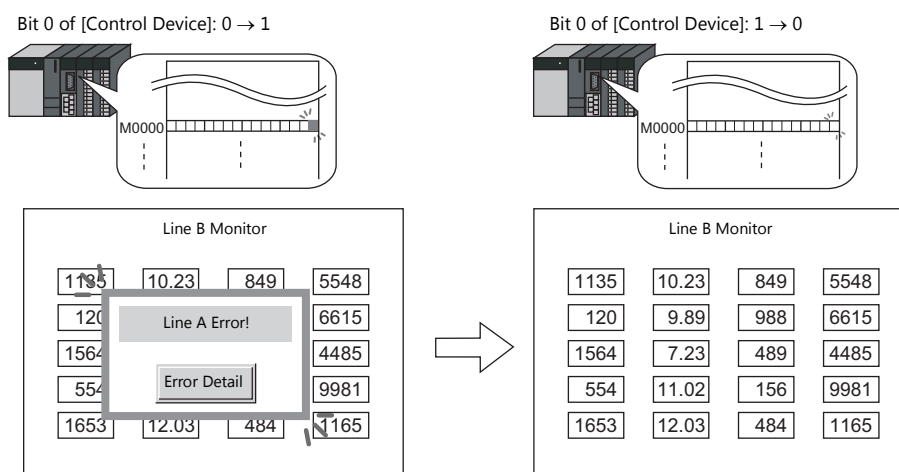

\* Recognition of bit status

The method used for bit recognition differs depending on the setting of [Display Overlap during bit ON] on the [General Settings] tab accessible by clicking [System Setting] → [Unit Setting] → [General Setting].

- Unselected:

The change (edge) from 0 to 1 or 1 to 0 is used to recognize bit status.

- Selected:

Level recognition is used to determine the bit status.

Suppose that an overlap display was shown on the screen using an external command, the screen was switched to another screen, and then the first screen is displayed again. In this case, the overlap display that corresponds to the bit being turned ON appears on the screen.

\* Notes on showing an overlap display using an external command

A switch for [Function: Overlap Control = OFF] can be used to hide the overlap display. Using this type of switch hides the overlap display with the bit of the control device memory still turned ON. To show the overlap display again, the bit needs to be turned OFF and ON again.

## 2.3 Call-overlap

### 2.3.1 Creation Procedure

1. Creating from an Overlap Library

- 1) Display an [Overlap Library Edit] tab window by clicking [Home] → [Registration Item] → [Overlap Library].

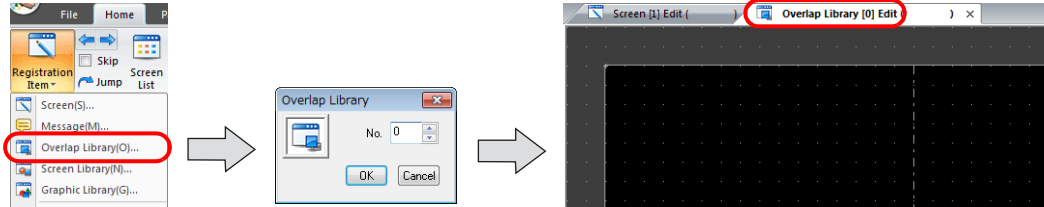

- 2) Click [Parts] or [Home] → [Overlap] → [Normal Overlap] and place an overlap.

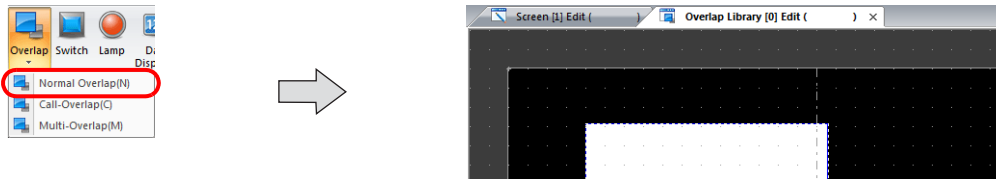

- 3) Adjust the size of the overlap.

- 4) Select [Overlap Editing] → [ID 0] on the right-click menu. The overlap editing window is displayed.

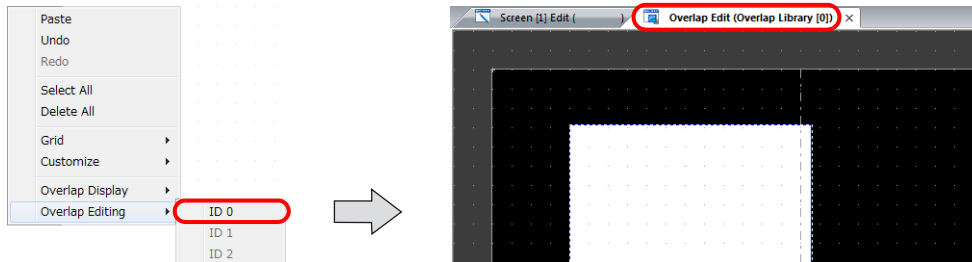

- 5) Place switches, lamps, and other items on the overlap.

- 6) Select [Overlap Editing] → [ID 0] on the right-click menu. The user is returned to the screen editing window.

2. Placing Call-Overlaps

- 1) In the screen editing window, click [Parts] → [Overlap] → [Call-Overlap] and place an overlap.
- 2) Click the icon and display the settings menu.
- 3) Configure the [Operation Select] settings.

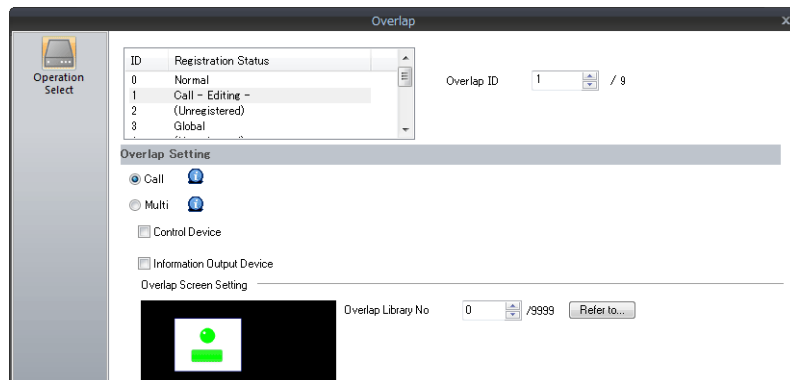

Overlap Setting	Call
Overlap Screen Setting	Set the overlap library number.

3. If performing showing/hiding with a switch, place a switch. [page 2-16](#)
4. If performing showing/hiding with commands from a PLC, configure the [Control Device] settings. [page 2-15](#)

## 2.3.2 Detailed Settings

### Operation Select

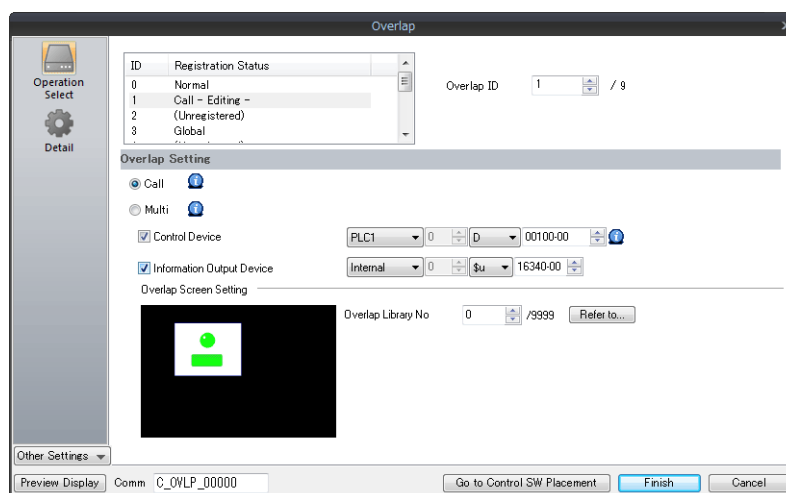

Item	Description
Registration Status	Check the registration status of overlap IDs 0 to 9. "- Editing -" is shown for the ID that is currently being edited. The overlap ID can also be changed to an unregistered ID.
Overlap Setting	Call  Overlap library number Set the library number of the overlap for display from those registered in the overlap library. Click [Refer to] to select using a list display or thumbnails.
Control Device	Specify a device using one bit. Showing and hiding is performed according to the value of the least significant bit. 0 → 1: Show 1 → 0: Hide * Select the [Display Overlap during bit ON] checkbox at [System Setting] → [Unit Setting] → [General Setting] to allow level operation. Refer to <a href="#">page 2-13</a> .
Information Output Device	Specify a device using one bit. Stores the overlap display status. 0: Hide 1: Shown

### Detail

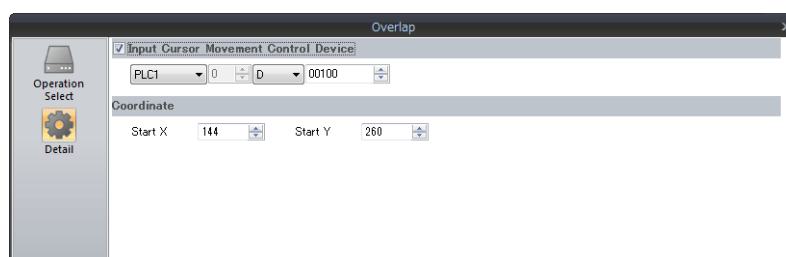

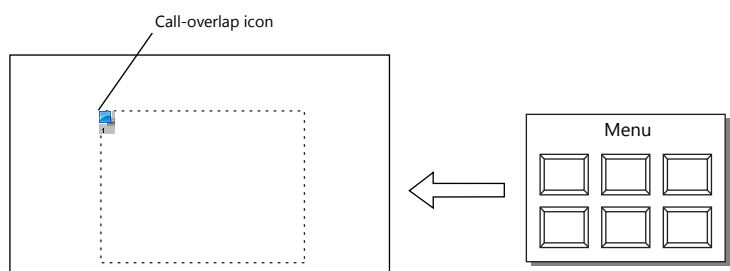
Item	Description
Input Cursor Movement Control Device	This setting is required to use the "entry function" on an overlap display. For details, refer to <a href="#">page 6-33</a> .
Coordinate	Start X/Start Y Set the display position of the overlap using X and Y coordinates.  

### 2.3.3 Show/Hide Settings

There are three methods for showing and hiding call-overlap displays.

Method		Error Detail	Refer to
Internal command	Switch	Function: Overlap Control Set Display No.: Unselected	page 2-15
	Macro	OVL_P_SHOW OVL_P_POS	page 2-12
External Command	Control device memory	0 → 1: Show 1 → 0: Hide	page 2-13

#### Switch

#### Setting

1. Display the settings menu of the call-overlap display.
2. Click [Go to Control SW Placement] and place a switch.

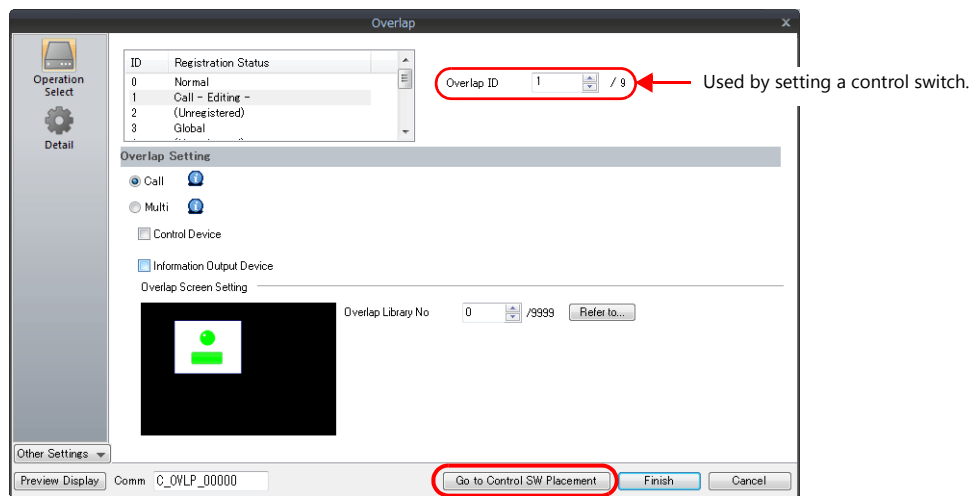

3. Set the function of the switch.

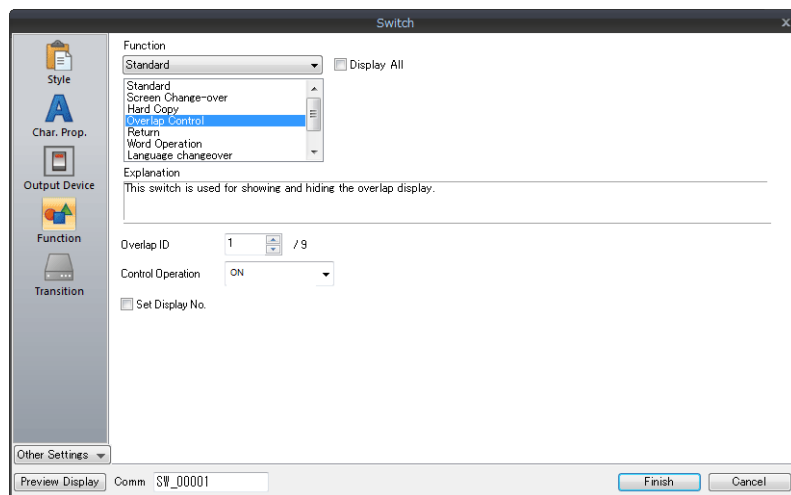

Function	Overlap Control
Overlap ID	Specify the same ID as the [Overlap ID] of the call-overlap.
Control Operation	ON: Show OFF: Hide ALT: Alternate between show and hide ICON: Show
Set Display No.	Unselected



## 2.4 Multi-overlap

### 2.4.1 Creation Procedure

#### 1. Creating from an Overlap Library

- 1) Display an [Overlap Library Edit] tab by clicking [Home] → [Registration Item] → [Overlap Library].

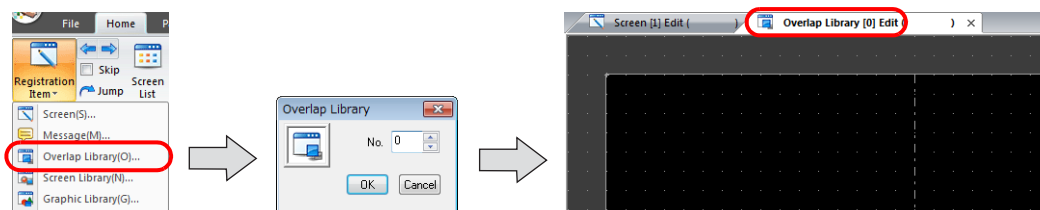

- 2) Click [Parts] or [Home] → [Overlap] → [Call-Overlap] and place an overlap.

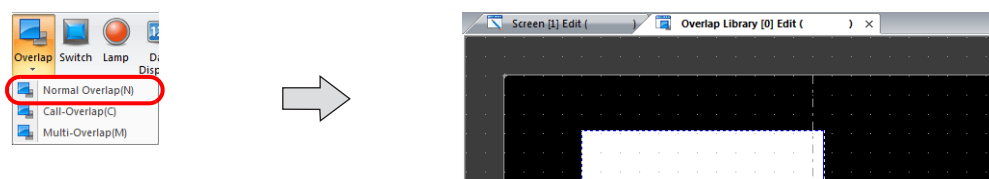

- 3) Adjust the size of the overlap.
- 4) Select [Overlap Editing] → [ID 0] on the right-click menu. The overlap editing window is displayed.

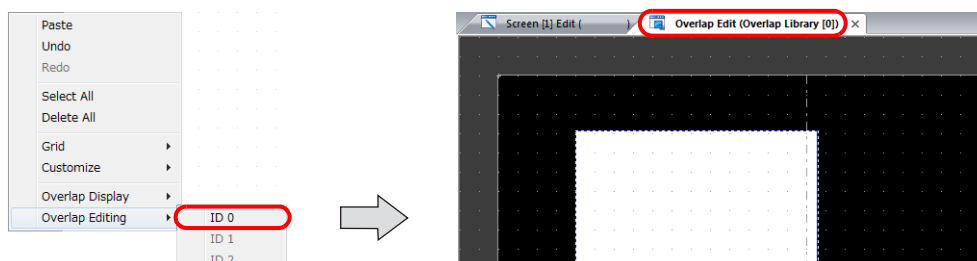

- 5) Place switches, lamps, and other items on the overlap.
- 6) Select [Overlap Editing] → [ID 0] on the right-click menu. The user is returned to the screen editing window.

#### 2. Placing a Multi-Overlap

- 1) In the screen editing window, click [Parts] → [Overlap] → [Multi-Overlap] and place an overlap.
- 2) Click the icon and display the settings menu.
- 3) Configure the [Operation Select] settings.

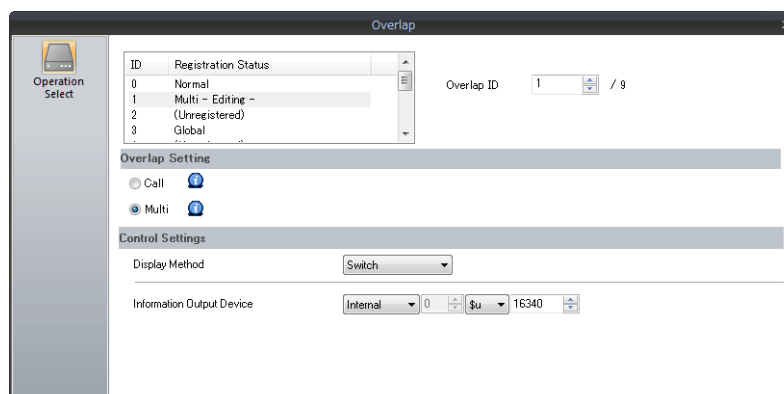

Overlap Setting		Multi
Control Settings	Display Method	Switch Use switches for showing and hiding. Refer to <a href="#">page 2-20</a> .
	Control Device	Use commands from a PLC for showing and hiding. Refer to <a href="#">page 2-21</a> .

## 2.4.2 Detailed Settings

### Operation Select

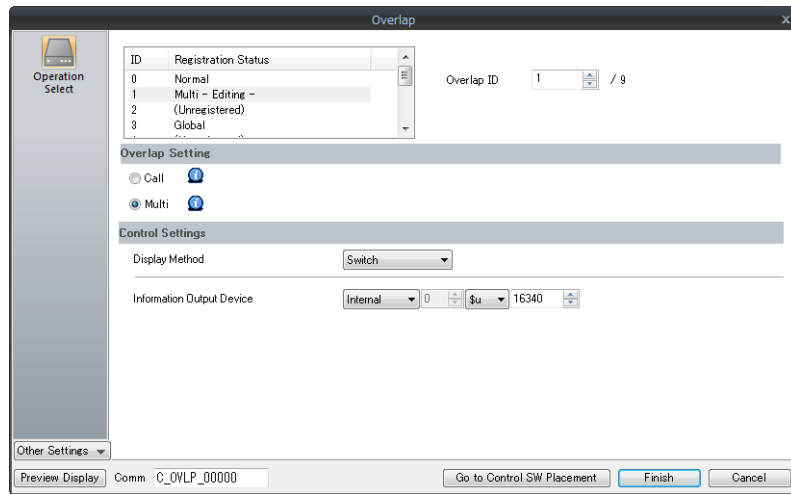

Item	Description
Registration Status	Check the registration status of overlap IDs 0 to 9. "- Editing -" is shown for the ID that is currently being edited. The overlap ID can also be changed to an unregistered ID.
Overlap Setting	Multi
Control Settings	Select the overlap display method (Switch/Control Device).

### Display method

- Switch

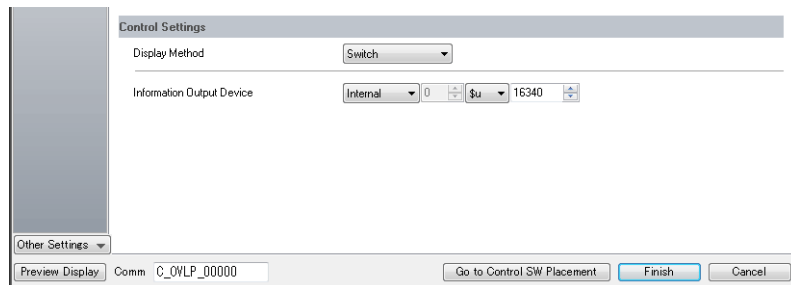

Item	Description
Switch	Control showing and hiding of the overlap using the switch function.
Information Output Device	Store the overlap library number. Show: 0 to 9999 Hide: -1 (FFFFHex)

- Control Device

Item	Description
Control Device	Specify a device memory using one bit. Showing and hiding is performed according to the value of the least significant bit. 1 (level): Show 0 (level): Hide
Information Output Device	Store and set the following information using a maximum of 4 words.
Device for Overlap Library No. to Display	Information Output Device    n    Stores the overlap library number. Show: 0 to 9999 Hide: -1 (FFFFHex)    V →
Specify the display position by device	Device for Overlap Library No. to Display    n+1    Set the overlap library number of the overlap for display.    V ←
	Specify the display position by device <sup>*1</sup> n+2    Set the X coordinate.    V ←
	Specify the display position by device <sup>*1</sup> n+3    Set the Y coordinate.    V ←

\*1 Set the unit of the placement coordinates. [System Setting] → [Unit Setting] → [Overlap] → [Overlap Coordinates]

Line/Column: X coordinate in 8 pixels, Y coordinate in 20 pixels

Dot: X coordinate in 4 pixels, Y coordinate in 1 pixel

## Detail

Item	Description
Input Cursor Movement Control Device	This is required for using "entry mode" on an overlap display. For details, refer to <a href="#">page 6-33</a> .
Coordinate	The coordinates of the multi-overlap icon. This setting is unrelated to the operation of MONITOUCH.

### 2.4.3 Show/Hide Settings

There are three methods for showing and hiding multi-overlap displays.

Method		Error Detail	Refer to
Internal command	Switch	Show	Function: Set Display No.: Overlap Control Selected
		Hide	Function: Control Operation: Set Display No.: Overlap Control OFF Unselected
	Macro	SET_MOVL OVL_POS	page 2-21
External Command	Control device memory	0: Hide 1: Show	page 2-21

#### Switch

A switch can be used to show and hide multi-overlap displays.

#### Setting

1. Display the settings menu of the multi-overlap display.
2. Click [Go to Control SW Placement] and place a switch.

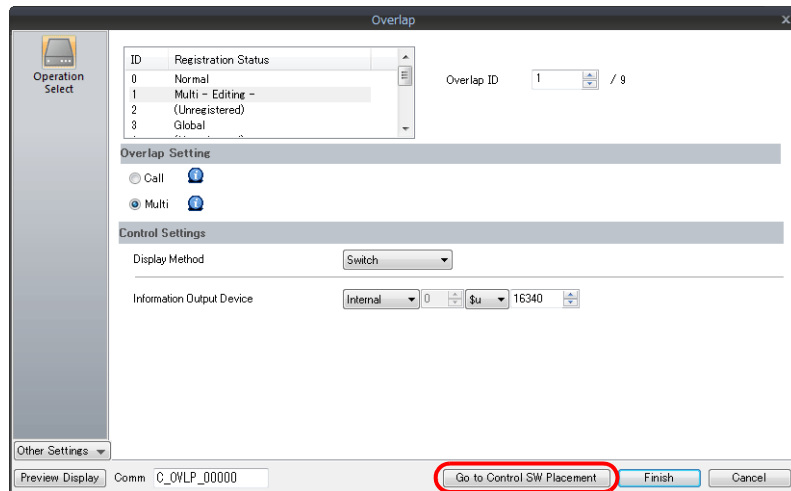

3. Set the function to use.

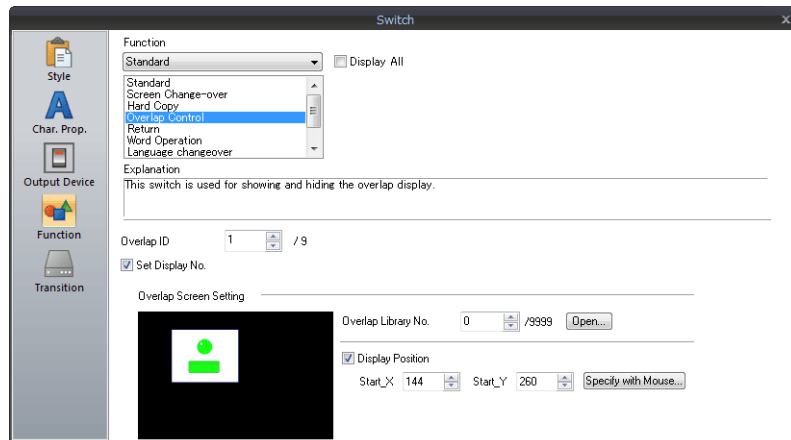

Function	Overlap Control	
Overlap ID	Specify the same ID as the [Overlap ID] of the multi-overlap.	
Show	Set Display No.	Selected
	Overlap Library No.	Set the overlap library number of the overlap for display.
	Display Position	Set the X and Y coordinates.
Hide	Control Operation	OFF: Hide
	Set Display No.	Unselected

## Macro

A macro can be used to show and hide multi-overlap displays. Use the "SET\_MOVL" and "OVL\_SHOW" commands. The "OVL\_POS" command is used to specify the display position. For details, refer to the V9 Series Macro Reference Manual.

## Setting

1. Creating a macro for showing an overlap display

- 1) Display the [Macro Block No. Editor] window.
- 2) Register the following macro.

\$u100 = 2 (W)                      Set an overlap ID from 0 to 9 (ID2 in this example).  
 \$u101 = 12 (W)                    Set an overlap library number from 0 to 9999 (No. 12 in this example).  
 \$u102 = 150 (W)                  X coordinate  
 \$u103 = 50 (W)                    Y coordinate  
 SYS (SET\_MOVL) \$u100            Execute the command.

- 3) Execute the macro block in a switch ON macro or global macro.

2. Creating a macro for hiding an overlap display

- 1) Display the [Macro Block No. Editor] window.
- 2) Register the following macro.

\$u100 = 2 (W)                      Set an overlap ID from 0 to 9 (ID2 in this example).  
 \$u101 = 0 (W)                      Hide the overlap display  
 SYS (OVL\_SHOW) \$u100            Execute the command.

- 3) Execute the macro block in a switch ON macro or global macro.

## Control Device Memory

## Setting

1. In the multi-overlap settings menu, click [Operation Select] and configure the [Control Device] and [Information Output Device] settings under [Control Settings].

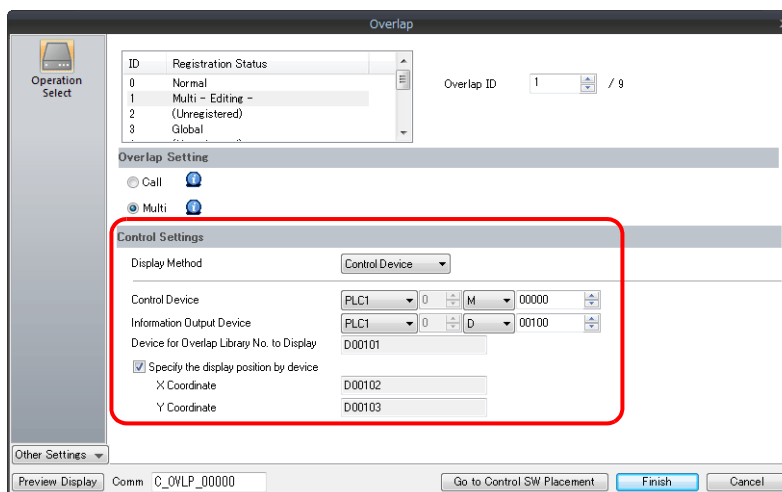

2. Set the library number of the overlap for display to the [Device for Overlap Library No. to Display]. When specifying the display position, also set the X and Y coordinates.

Information Output Device	n	Store the overlap library number. Show: 0 to 9999 Hide: -1 (FFFFHex)	V →
Device for Overlap Library No. to Display	n+1	Set the overlap library number of the overlap for display.	V ←
Specify the display position by device	n+2	Set the X coordinate.	V ←
	n+3	Set the Y coordinate.	V ←

3. The overlap is shown when the [Control Device] bit is ON and hidden when the bit is OFF.

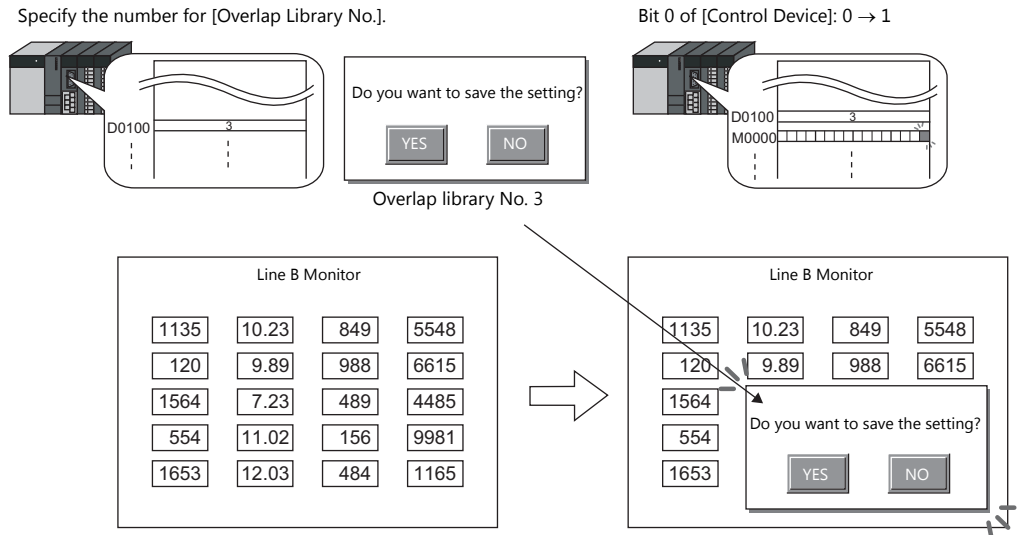

**\* Notes on showing an overlap display using an external command**

- Suppose that an overlap display was shown on the screen using an external command, the screen was switched to another screen, and then the first screen is displayed again. In this case, the overlap display that corresponds to the bit being turned ON appears on the screen.
- A switch for [Function: Overlap Display = OFF] can be used to hide the overlap display. Using this type of switch hides the overlap display with the bit of the control device memory still turned ON. To show the overlap display again, the bit needs to be turned OFF and ON again.

## 2.5 Global Overlap

### 2.5.1 Creation Procedure

#### 1. Creating from an Overlap Library

- 1) Display an [Overlap Library Edit] tab window by clicking [Home] → [Registration Item] → [Overlap Library].

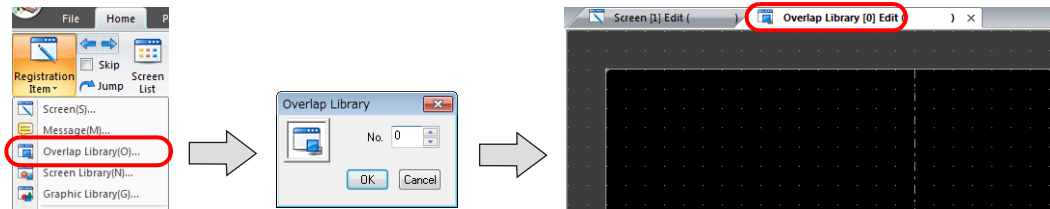

- 2) Click [Parts] or [Home] → [Overlap] and place an overlap.

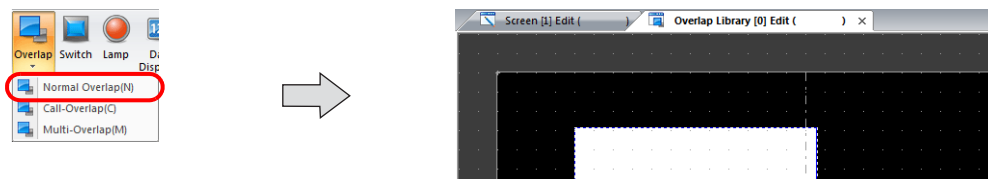

- 3) Adjust the size of the overlap.

- 4) Select [Overlap Editing] → [ID 0] on the right-click menu. The overlap editing window is displayed.

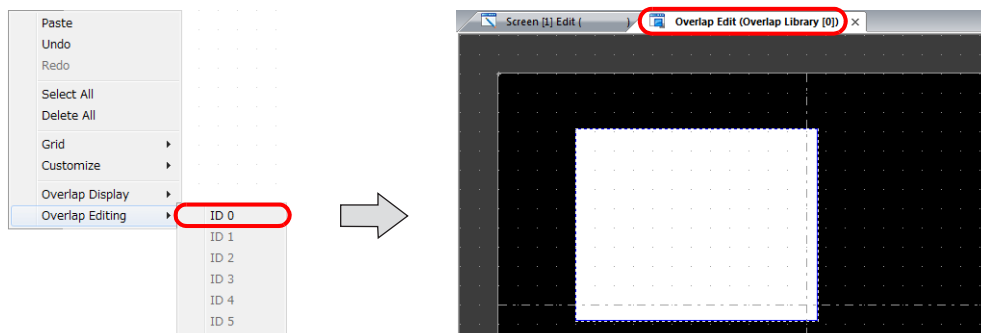

- 5) Place switches, lamps, and other items on the overlap.

- 6) Select [Overlap Editing] → [ID 0] on the right-click menu. The user is returned to the screen editing window.

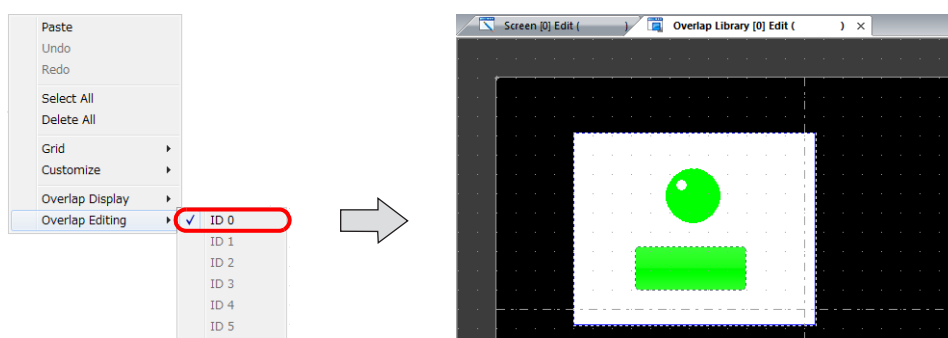

2. Global Overlaps

- 1) Click [System Setting] → [Global Setting] → [Global Overlap Setting].
- 2) Select the [Use Overlap] checkbox.
- 3) Select the [Use Global Overlap] checkbox on the tab corresponding to the ID to use from IDs 0 to 9.

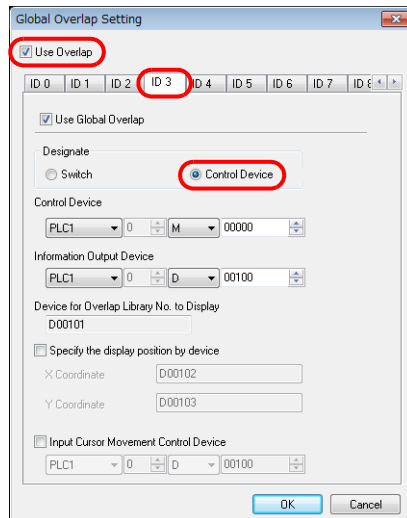
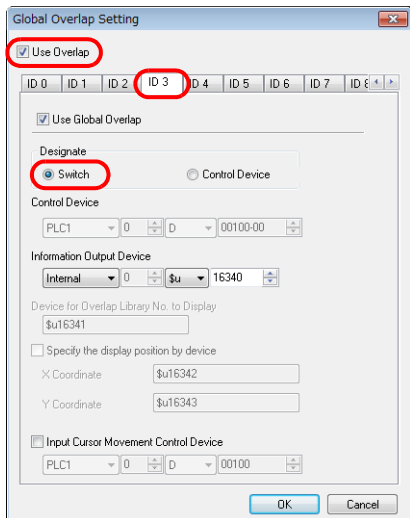

3. Select a display method under [Designate].

Item		Description
Overlap Setting		Multi
Control Settings	Switch	Use switches for showing and hiding. Refer to <a href="#">page 2-26</a> .
	Control Device	Use commands from a PLC for showing and hiding. Refer to <a href="#">page 2-27</a> .



## 2.5.2 Detailed Settings

### Display Method Selection

- Switch

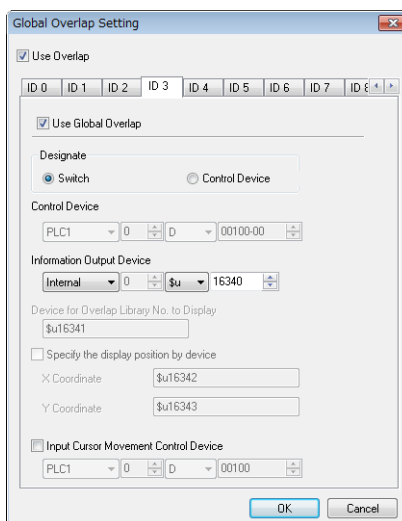

Item	Description
Switch	Control showing and hiding of the overlap using the switch function.
Information Output Device	Store the overlap library number. Show: 0 to 9999 Hide: -1 (FFFFHex)
Input Cursor Movement Control Device	This setting is required to use the "entry function" on an overlap display. For details, refer to <a href="#">page 6-33</a> .

- Control Device

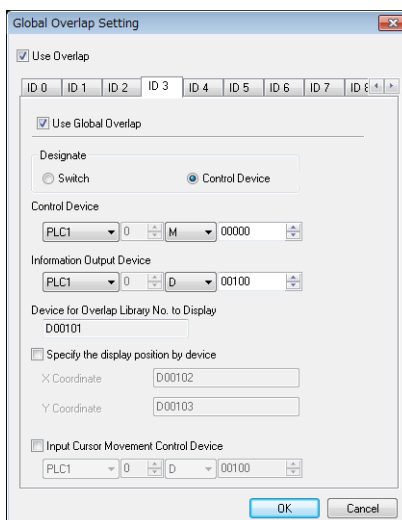

Item	Description	
Control Device	Specify a device using one bit. Showing and hiding is performed according to the value of the least significant bit. 1 (level): Show 0 (level): Hide	
Information Output Device	Store and set the following information using a maximum of 4 words.	
Device for Overlap Library No. to Display	Information Output Device   n   Stores the overlap library number. Show: 0 to 9999 Hide: -1 (FFFFHex)   V →	
Display Position	Device for Overlap Library No. to Display   n+1   Set the overlap library number of the overlap for display.   V ←	
	Specify the display position by device <sup>*1</sup>	n+2   Set the X coordinate.   V ←
		n+3   Set the Y coordinate.   V ←
Input Cursor Movement Control Device	This setting is required to use the "entry function" on an overlap display. For details, refer to <a href="#">page 6-33</a> .	

### 2.5.3 Show/Hide Settings

There are three methods for showing and hiding global overlap displays.

Method		Error Detail	Refer to
Internal command	Switch	Function: Overlap Control Set Display No.: Selected	<a href="#">page 2-26</a>
	Macro	SET_MOVL OVL_SHOW OVL_POS	<a href="#">page 2-27</a>
External Command	Control device memory	0: Hide 1: Show	<a href="#">page 2-27</a>

#### Switch

A switch can be used to show and hide global overlap displays.

#### Setting

1. Click [Parts] → [Switch] and place a switch.

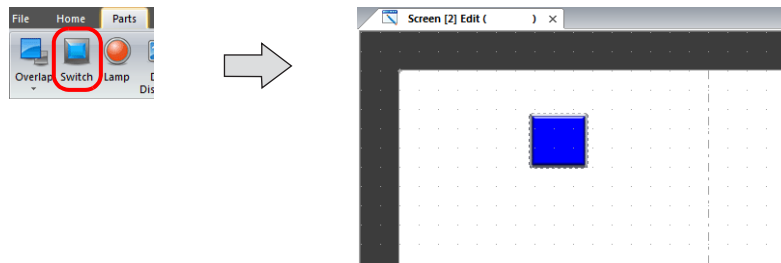

2. Set the function to use.

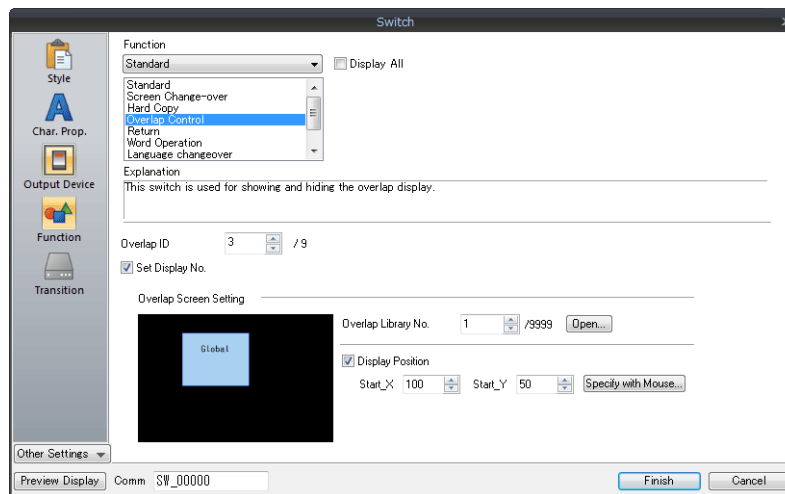

Function	Overlap Control
Overlap ID	Specify the same ID as the [Overlap ID] of the global overlap.
Control Operation	ON: Show OFF: Hide ALT: Alternate between show and hide ICON: Show
Set Display No.	Selected:
Overlap Library No.	Set the overlap library number of the overlap for display.
Display Position	Set the X and Y coordinates.

## Macro

A macro can be used to show and hide global overlap displays. Use the "SET\_MOVL" and "OVL\_SHOW" commands. The "OVL\_POS" command is used to specify the display position. For details, refer to the V9 Series Macro Reference Manual.

## Setting

1. Creating a macro for showing an overlap display

- 1) Display the [Macro Block No. Editor] window.
- 2) Register the following macro.

\$u100 = 3 (W)	Set an overlap ID from 0 to 9 (ID3 in this example).
\$u101 = 12 (W)	Set an overlap library number from 0 to 9999 (No. 12 in this example).
\$u102 = 150 (W)	X coordinate
\$u103 = 50 (W)	Y coordinate
SYS (SET_MOVL) \$u100	Execute the command.

- 3) Execute the macro block in a switch ON macro or global macro.

2. Creating a macro for hiding an overlap display

- 1) Display the [Macro Block No. Editor] window.
- 2) Register the following macro.

\$u100 = 3 (W)	Set an overlap ID from 0 to 9 (ID3 in this example).
\$u101 = 0 (W)	Hide the overlap display
SYS (OVL_SHOW) \$u100	Execute the command.

- 3) Execute the macro block in a switch ON macro or global macro.

## Control Device Memory

## Setting

1. In the global overlap settings menu, configure the [Control Device] settings.

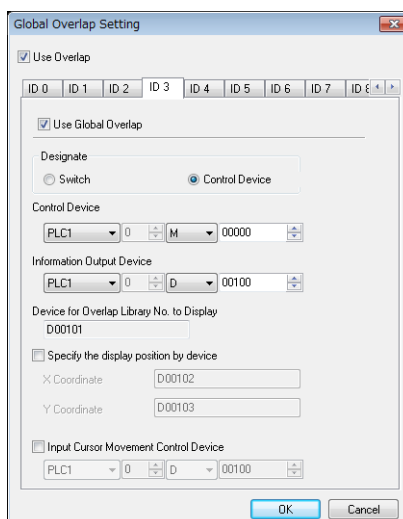

2. Set the library number of the overlap for display to the [Device for Overlap Library No. to Display]. When specifying the display position, also set the X and Y coordinates.

Information Output Device	n	Store the overlap library number. Show: 0 to 9999 Hide: -1 (FFFFHex)	V →
Device for Overlap Library No. to Display	n+1	Set the overlap library number of the overlap for display.	V ←
Specify the display position by device	n+2	Set the X coordinate.	V ←
	n+3	Set the Y coordinate.	V ←

3. The overlap is shown when the [Control Device] bit is ON and hidden when the bit is OFF.

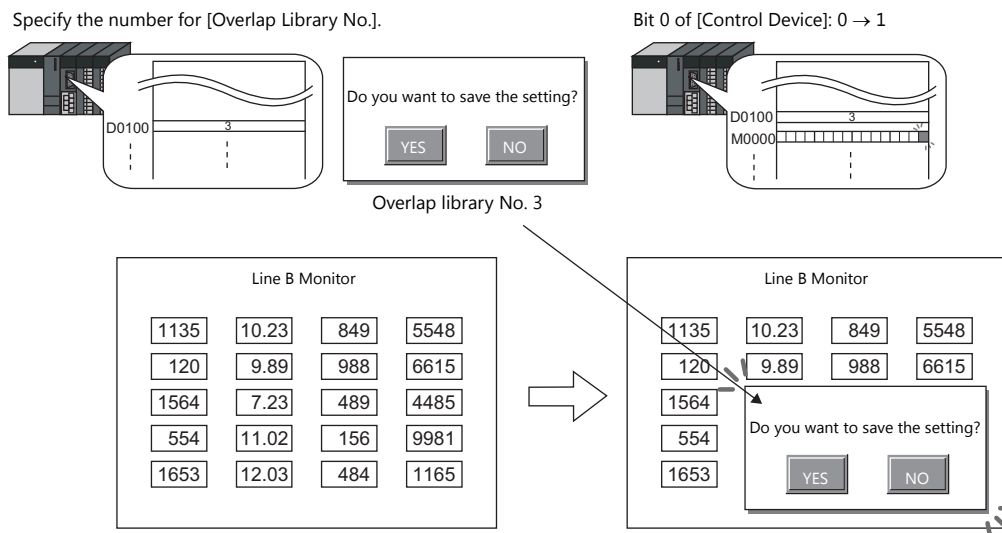

\* Notes on showing an overlap display using an external command

A switch for [Function: Overlap Display = OFF] can be used to hide the overlap display. Using this type of switch hides the overlap display with the bit of the control device memory still turned ON. To show the overlap display again, the bit needs to be turned OFF and ON again.

## 2.5.4 Notes

- Global overlaps are redisplayed when the display language is changed.
- Global overlap displays cannot be set for component parts nor called upon from component parts.

## 2.6 Display Transparency

### 2.6.1 Overview

- When an overlap is displayed, it blocks the display of anything behind it. By using transparency, an overlap can be displayed while retaining the ability to check information behind it.

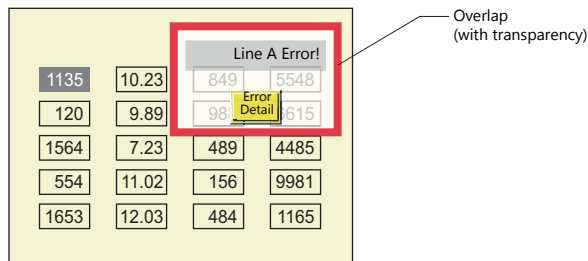

- All overlaps from ID 0 to 9 can be set to be transparent.
- The level of transparency for the overlap can be determined by the [Blend] value setting. The blend value for transparency can be set in the [Screen Setting] window that is displayed from the [Screen Setting] menu. This setting applies to the relevant screen and cannot be configured for individual overlaps.
- The blend value for superimposing a global overlap display depends on the settings made for the screen, on which the overlap is first displayed.

### 2.6.2 Setting Procedure

- Display the [Screen Edit] window.
- Click [Screen Setting] → [Screen Setting] → [Others].

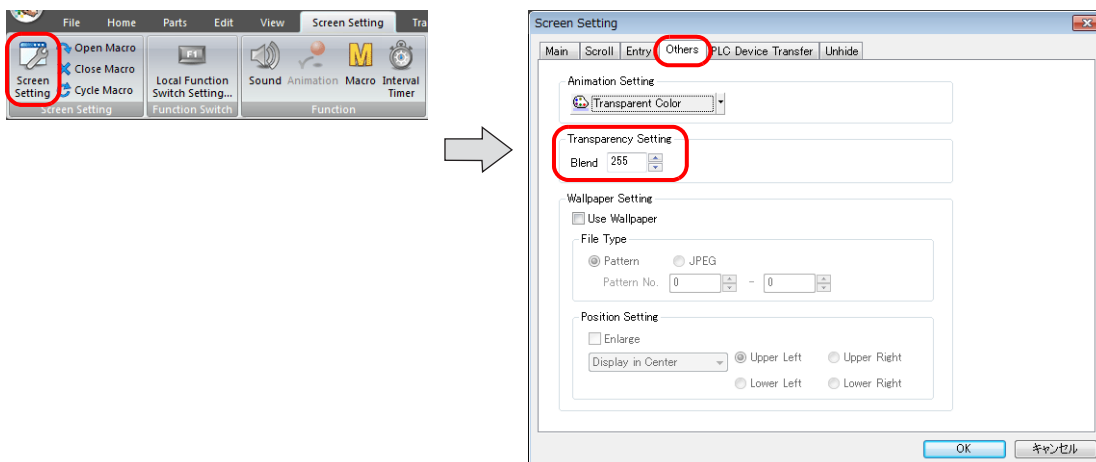

- Set a [Blend] value under [Transparency Setting].

Item	Description
Blend	Set the ratio of transparency used for overlap display. 0 (transparent) to 255 (opaque)

- Click the [OK] button to close the window.

Normal overlap display:

Transparency can also be set by clicking [Detail] → [Transparency Display] in the overlap settings. This setting is the same as the setting in [Screen Setting].

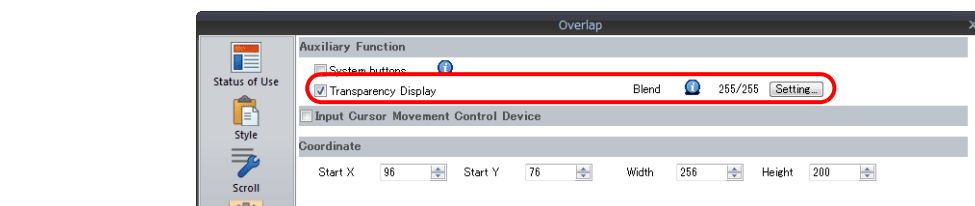

# MEMO

MONITOUCH



## **3 Switch**

---

3.1 Switch

3.2 Scroll Bars

3.3 Slider Switch

## 3.1 Switch

### 3.1.1 Overview

#### Basic Function of Switches

- Switches can send ON/OFF information to specific bits in PLC or internal device memory.

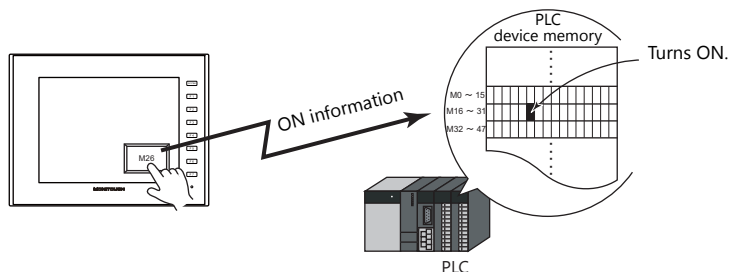

☞ For example settings, refer to "Setting the PLC bit to ON." page 3-4.

- When a switch is pressed, the following processes can be executed:
  - Changing the screen for display

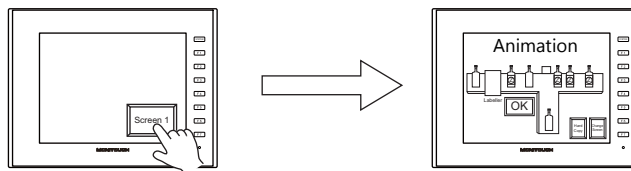

☞ For example settings, refer to "Changing Screens" page 3-5.

- Showing an overlap display

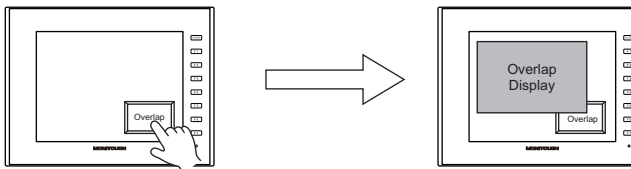

- Performing the configured calculations and writing the results to the device memory

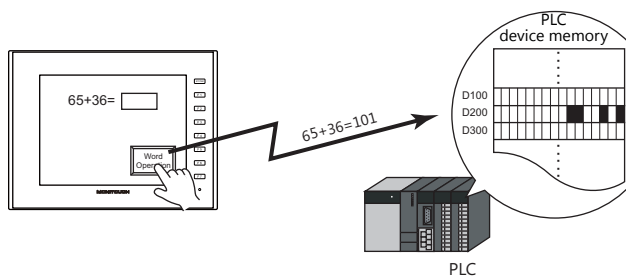

- Printing the displayed screen

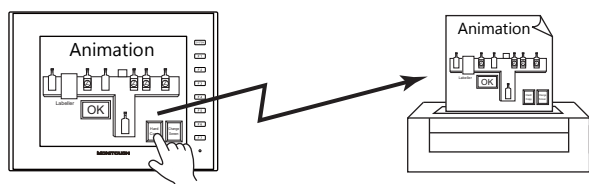



- Turning a device memory bit ON and showing an overlap display at the same time

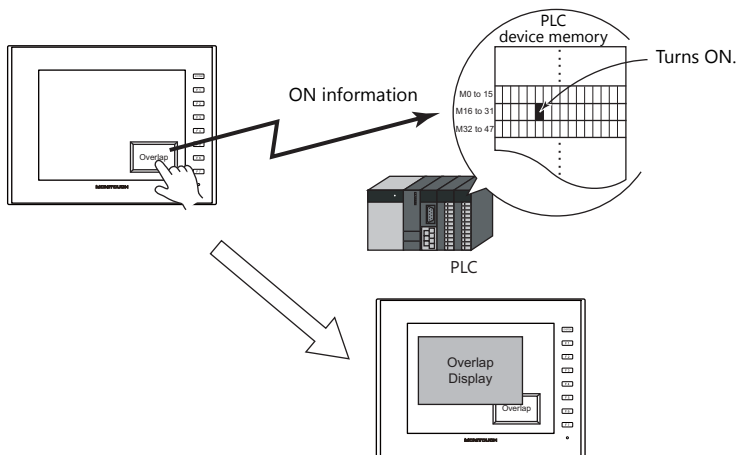

- When a switch is pressed, ON/OFF information or a value can be sent for multiple bits or words at the same time to a PLC device memory or internal device memory.

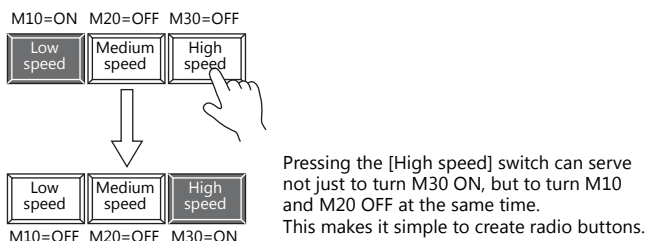

- A delay function can be added to switches. "ON delay" functions can be set, where device memory output cannot occur unless the switch is pressed continuously for a fixed time, and "OFF delay" functions can be set, where the device memory cannot go OFF until a fixed time has elapsed after the switch is released.

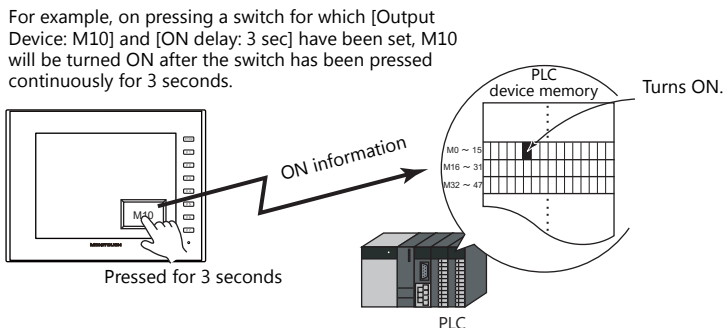

- A confirmation pop-up window, which asks whether to proceed with the operation or cancel the operation ([OK] or [Cancel]), can be configured to be displayed automatically when a switch is pressed. These settings for confirmation and operation execution can be configured entirely on the MONITOUCH, without any troublesome programming.

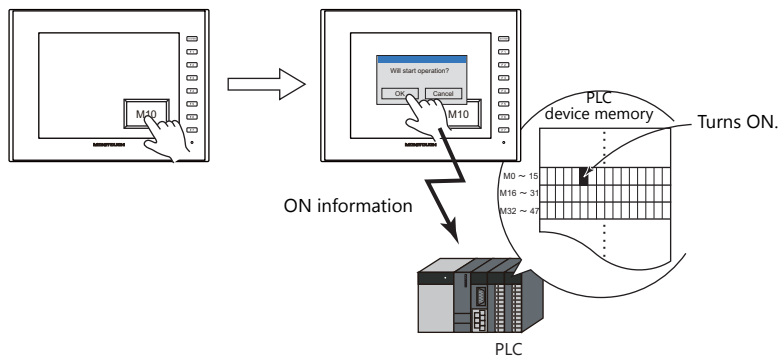

- A macro can be executed when a switch is pressed or released.

## Lamps in Switches

- There are switches available with lamps that light up (ON color) when the switch is pressed and turn off (OFF color) when released.

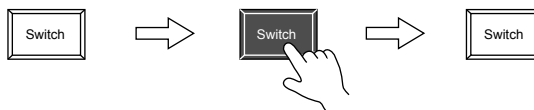

- Lamp activation can be instructed from an external device memory.

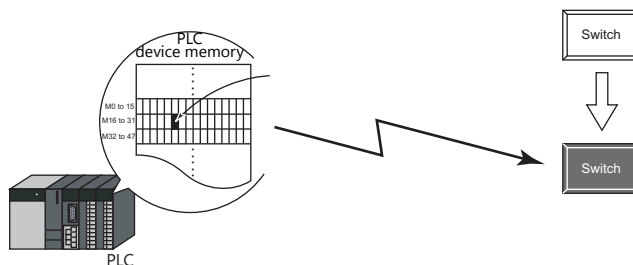

- When instructing lamp activation from an external device memory, a maximum of 128 patterns can be registered for a single lamp part.  
Example: 3 patterns



### 3.1.2 Setting Examples

#### Setting the PLC bit to ON.

Set PLC device memory M26 to ON while the switch is pressed and OFF after the switch is released.

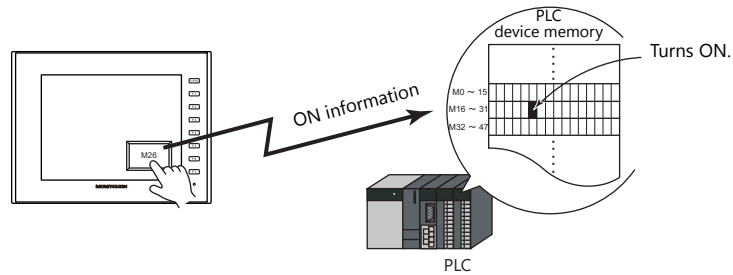

1. Click [Parts] → [Switch] and place a switch on the screen.

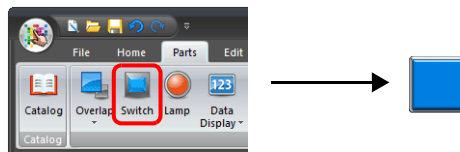

2. Double-click on the switch to display the settings window. Configure the following settings for [Output Device] and then click [Finish].

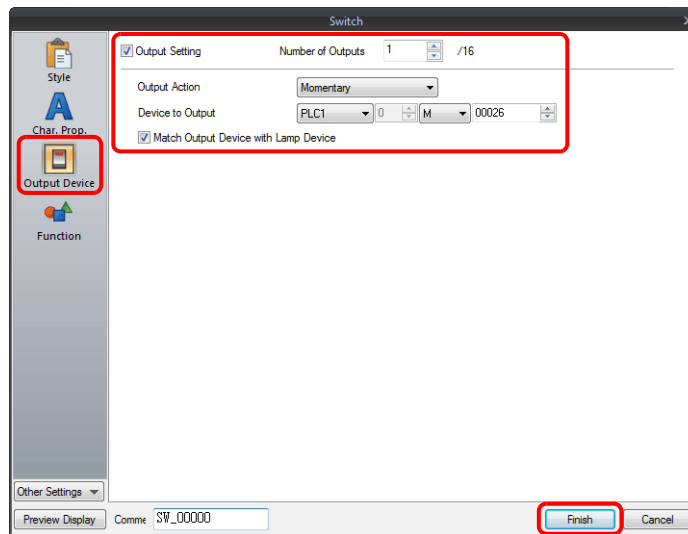

This completes the necessary settings.

## Changing Screens

Change to screen No. 1 when the switch is pressed.

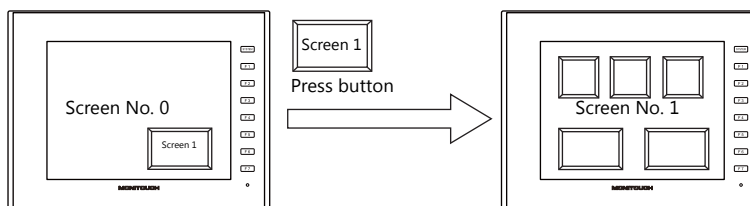

1. Click [Parts] → [Switch] and place a switch on the screen.

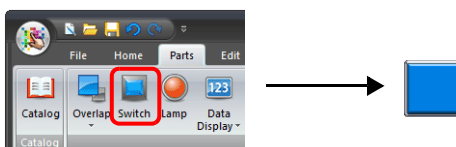

2. Double-click on the switch to display the settings window. Configure the following settings for [Function] and then click [Finish].

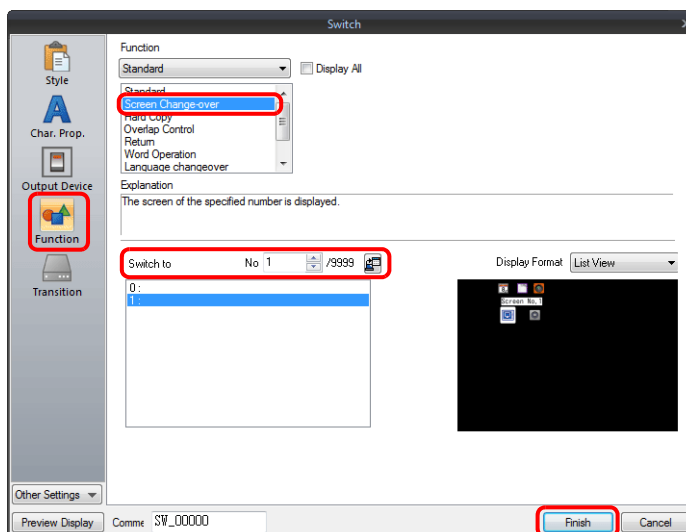

This completes the necessary settings.

### 3.1.3 Detailed Settings

#### Style

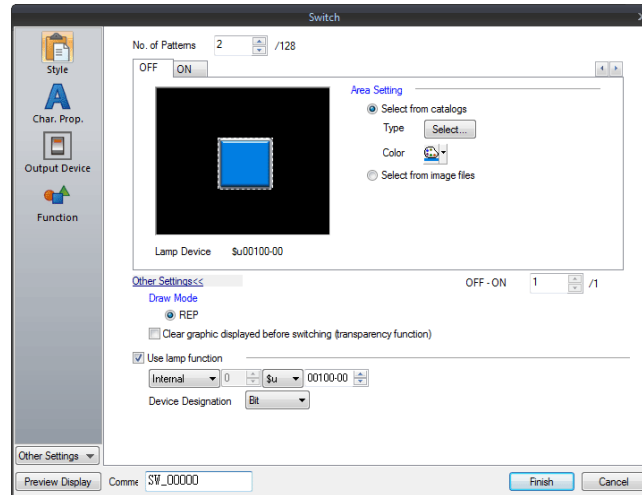

Item		Description
No. of Patterns (2 to 128)		Set the number of times the display of the switch lamp can be changed.
Area Setting	Select from catalogs	Select the part design. After selecting the part, select the part color.
	Select from image files	Select a PNG file. The PNG file can be set to all patterns by clicking [Apply to All Patterns].
Frame		This item is only available when [Shape: 2D] and [Group: Square2] are selected via [Select from catalogs].
		Type
		Select the frame type of the switch.
		Color
		Select the frame color of the switch.
Enable flash display function (flashing with OFF pattern)		This item is available when a 3D pattern type <sup>*1</sup> other than an OFF pattern (excluding "Sign" and "3D_128" parts) is selected. Select this checkbox to flash the display between the selected pattern and the OFF pattern.
Other Settings	Draw Mode REP/XOR	REP: Display using the color set in [Area Setting]. XOR: When the lamp device memory is ON, the frame and text are displayed in the color resulting from an XOR operation.  For the difference between REP and XOR, refer to <a href="#">"4.4 Draw Mode" page 4-11.</a>
	Clear graphic displayed before switching (transparency function)	The previous graphic is not retained when the checkbox is selected. For details, refer to <a href="#">"Draw Mode" page 4-11.</a>
Use lamp function		Select this checkbox to change the display in the switch area.  Unselected: When the switch is pressed, the lamp lights up automatically. The switch changes to the ON color when pressed and the OFF color when released.  Selected: Setting for the lamp device memory become available. Specify a device memory address for the lamp display. * <b>When placing multiple switches, set up consecutive addresses for the lamp device memory to ensure high-speed processing.</b>  For details, refer to <a href="#">"4 Lamp"</a> .
Device Designation		Bit: The lamp display is changed by setting (ON) and resetting (OFF) bits. The required number of bits depends on the number of display patterns. (127 bits maximum) When multiple bits are set (ON), the most significant bit has priority.  Word: The lamp display is changed according to the value specified for the device memory. The range of setting values varies with the number of patterns. (Range: 0 to 127) If a value outside the specified range is set, the lamp display is not changed.
Input Type (DEC/BCD)		Specify the input format of the device memory.

\*1 Notes on 3D and 2D pattern types  
Part shapes differ depending on the selection made in the catalog.

- 3D type: Real, Sign, 3D, 3D\_128, HA
- 2D type: 2D

Selection of an image file corresponds to the 3D type.

## Char. Prop.

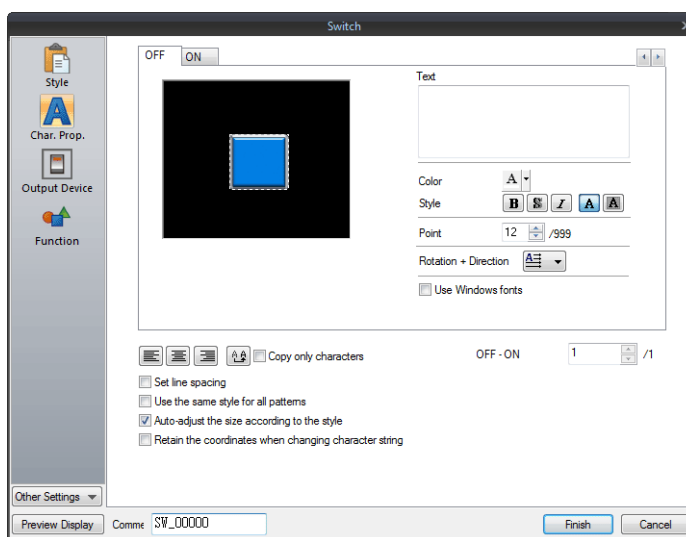

Item	Description
[OFF] [ON] - [P128]	When [Style] → [Other Settings] → [Draw Mode] is [XOR]: Only [OFF] can be selected. Specify the text to be displayed.
Pattern No. (0 to 127)	When [Style] → [Other Settings] → [Draw Mode] is [REP]: Specify the text to be displayed on each pattern.
Text	Enter the text to be displayed on the switch. Up to 4 lines can be registered. Text properties can be set for each line. Text can be justified within the switch part.
Color (text color, background color)	Set the color for text. The background color can also be set if set as "no transparency" in the following [Style] setting.
Style	Set the text style.
Character Size (1 to 8)	Specify the enlargement factor for text.
Point (6 to 999)	Set the text size.
Rotation + Direction	Set the combination of text rotation and direction. Four combinations are displayed in the drop-down menu.  When selecting an option other than the above, click the icon at the bottom. The window that allows selection from all options is displayed.
Use Windows fonts	Select this checkbox to use a Windows font.
Smooth Font *1	Smooth the edges of text. (Only settable for TrueType Windows fonts.)
Alignment	Set the text alignment.  
Text copy Copy only characters	The text and its attributes for the current pattern (OFF, ON, P3) are copied to the other patterns. Select the [Copy only characters] checkbox to copy text and coordinate information to all other patterns. Note that the text properties will not be copied. If the destination for copy has no text, text properties will also be copied.
Set line spacing	Set the pitch between lines.
Use the same style for all patterns	Select this checkbox to configure the same settings as the opened pattern attributes with respect to all switch patterns (for each respective line if multiple lines are included).
Auto-adjust the size according to the style	Select this checkbox to automatically adjust the switch size to the entered text.
Retain the coordinates when changing character string	Newly registered text is placed by centering. When any registered text is changed while this checkbox is selected, the coordinates remain the same. When a line is added to the existing text while this checkbox is selected, the added line is aligned with the upper line.
4-Line Display	Select this checkbox to divide the text entry area into four lines. This allows different properties to be specified for each line when using Windows fonts.

\*1 Cannot be set to transparent.

## Output Device

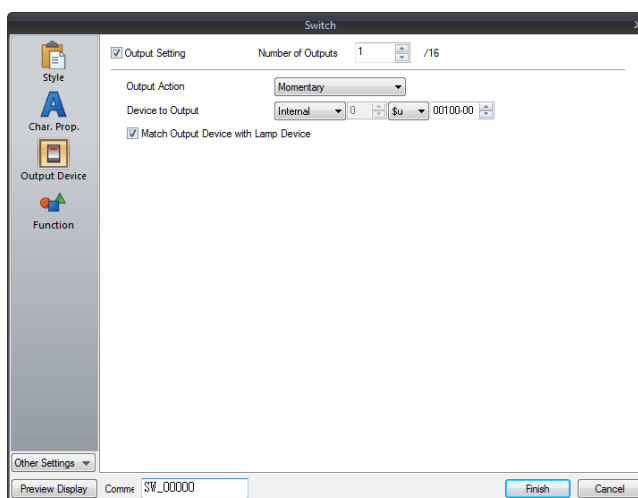

Item	Description
Output Setting	Select this checkbox to execute the specified output operation for the set output device when the switch is pressed.
Number of Outputs (1 to 16)	A maximum of 16 types of output operations can be executed at once when the switch is pressed. This value sets the number of operations to execute.  When the number of outputs is set to "2" or more, output operations are processed in sequence from No. 0. The output operations performed when the switch is released are also processed in sequence from No. 0.
Output Action *1	Momentary: Set the output device memory to ON. When the switch is released, set the output device memory to OFF. Set: Set the output device memory to ON. Reset: Set the output device memory to OFF. Alternate: Inverse the state of the output device memory (set to OFF if ON, set to ON if OFF). Momentary W: Set the output device memory to ON. When the switch is released, set the output device memory to OFF. Word Operation: Execute the set arithmetic expression. For details, refer to "Word operation" page 3-9.
Device to Output	Specify a PLC device memory, internal device memory, or tag. Processing speed will be faster when an internal device memory is selected than when a PLC device memory is selected. (Specify a bit for [Device to Output] when [Output Action] is set to a value other than [Word Operation].)
Match Output Device with Lamp Device	Select this checkbox to set the lamp device memory address to the same address set for [Device to Output]. When [Alternate] is set for [Output Action], the display reflects the status of the output device memory.

\*1 Notes on [Momentary] and [Momentary W] operation  
Processing differs depending on the type of PLC device memory specified for output (whether bits are writable or not). For information on PLC device memory types, refer to the relevant PLC manual.

- When a bit-writable device memory is specified:  
Processing for [Momentary] and [Momentary W] is the same.
- When a non-bit-writable device memory is specified:  
Because processing for switch operations is performed in units of bits on the V9 series, processing differs as described below

- Processing when [Momentary] is selected:
  - (1) One word of [Device to Output] is read.
  - (2) The result of [Output Action] is written to one word of [Device to Output]. (Other bits are kept intact.)

Example: When [D100 - 10] is specified for [Device to Output]:

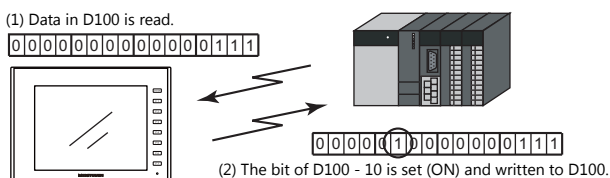

- Processing when [Momentary W] is selected:  
The result is directly written to one word of [Device to Output]. (Other bits are cleared.) Therefore, always secure one-word for [Device to Output].

Example: When [D100 - 10] is specified for [Device to Output]:

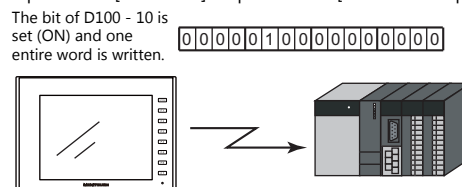

For a bit-writable device memory, select either [Momentary] or [Momentary W]. For a non-bit-writable device memory, it is recommended to select [Momentary W] for high-speed processing.

## Word operation

Item		Description	
Operation Setting	Operation Device	Specify the device memory address for operation.	
	Operation Mode	Transfer	Perform the specified arithmetic operation with [Operation Device] and [Operand Device] and write the result to the device memory set for [Address to Output Operation Result]. When performing division, the quotient is output to the device memory set for [Address to Output Operation Result] and the remainder is output to the device memory set for [Address to Output Operation Result] + 1.
		Add	
		Subtract	
		Multiply	
		Divide	
OR	AND	Perform the specified logical operation with [Operation Device] and [Operand Device] and write the result to the device memory set for [Address to Output Operation Result].	
	XOR		
Operand Device	Specify the device memory address for the operand. It is possible to use a constant.		
Address to Output Operation Result	Specify the device address where the operation result is output.		
Condition Setting	Comparison Condition	None	Operation is executed when the switch is pressed.
		=, ≠	Set the condition for executing the word operation. Condition satisfied: Word operation is executed. Condition not satisfied: Word operation is not executed.
		<, >	
	≤, ≥		
Comparison Device	Specify the device memory address where the comparison value is stored.		
Constant	Specify a constant.		
Operation Type (DEC/BCD)		Specify the operation format (format of writing to the specified device memory address).	

• Usage Example

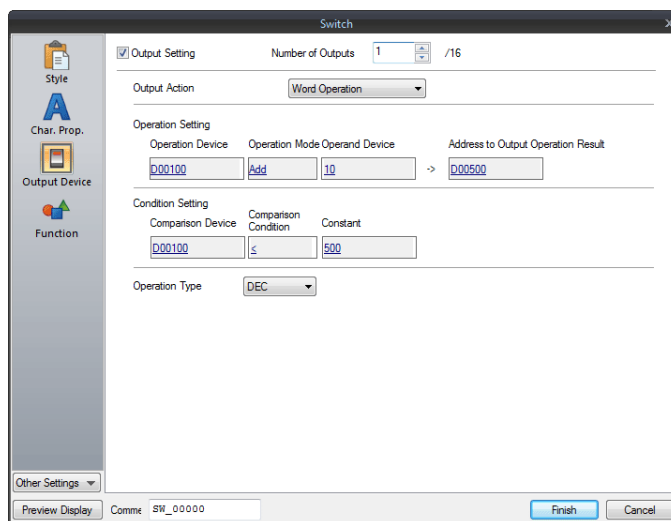

Operation Setting

Operation Device	Operation Mode	Operand Device		Address to Output Operation Result
D500	Add	10	→	D500

Condition Setting

Comparison Device	Comparison Condition	Constant
D100	<	500

Operation Type: DEC

When the data in D100 is less than "500", the operation (D500 + 10 → D500) is executed.

• Notes

- If the value of the [Address to Output Operation Result] device memory is changed by an external command, the latter value has priority.
- MONITOUCH processes operations in the following order:
  - 1) Reads the [Operation Device] and [Operand Device].
  - 2) Operation processing
  - 3) Writes the operation result to the [Address to Output Operation Result] device memory.



## Function

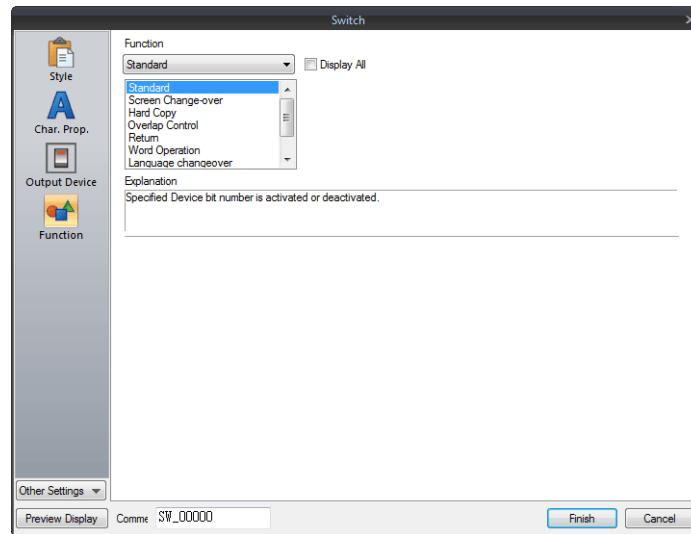

Item		Description
Function		Select the function to assign to the switch, that is, how the switch should work when pressed.
Standard	Standard	Set the bit of the specified device memory ON/OFF.
	Screen Change-over <sup>*1 *2</sup>	Change to the specified screen number (0 to 9999).
	Hard Copy <sup>*3</sup>	Print the currently displayed screen image. Operations can be performed normally on the screen during printing.
	Overlap Control	Show or hide an overlap. For details, refer to <a href="#">"2 Overlap"</a> .
	Return <sup>*4 *5</sup>	Return to the previously displayed screen. Up to 8 previous screens can be displayed.
	Word Operation	Execute the set arithmetic expression. Select the [Changeover the screen] checkbox to change to the specified screen number after executing an operation. For details on word operations, refer to <a href="#">"Word operation"</a> page 3-9.
	Language changeover	Change the display language. For details, refer to <a href="#">"9 Language Changeover"</a> in the V9 Series Reference Manual 2.
	Storage Removal	Stop access to a storage device. For details, refer to <a href="#">"Storage Removal (Stopping Access to a Storage Device)"</a> page 3-24.
	Ladder Monitor	Used in conjunction with the ladder monitor function. For more information, refer to the V9 Series Ladder Monitor Specifications manual.
	Operation Log Viewer Display	Used in conjunction with the operation log. For details, refer to <a href="#">"4 Operation Log"</a> in V9 Series Reference Manual 2.
	Video Player Display	Used in conjunction with the video player. For details, refer to <a href="#">"15 Video Player"</a> in V9 Series Reference Manual 2.
	PDF Viewer Display	Used in conjunction with the PDF viewer. For details, refer to <a href="#">"13 PDF Viewer"</a> in V9 Series Reference Manual 2.
	Recipe	Recipe Data Load
Recipe Data Save		
Recipe Data Delete		
Security	Log In	Used in conjunction with the security function. For details, refer to <a href="#">"5 Security"</a> in the V9 Series Reference Manual 2.
	Log Out	
Display All		Display all switch functions. For details, refer to <a href="#">"3.1.4 Basic Function of Switches"</a> page 3-19.

- \*1 When the screen display is changed, all the switches and switch outputs should be turned OFF. This is to prevent accidental activation of any switch that may be caused by inadvertent contact with the screen.
- \*2 It is possible to change the screen display without using the switch function by instead using an external command from the PLC. For information on changing the screen from a PLC, refer to ["1.1.3 Communication Setting"](#).
- \*3 When the screen is printed with a [Function: Hard Copy] switch, the switch is also printed out. To prevent the switch from appearing on the printout, use an external command to print instead. For details on printing using an external command, refer to ["16 Print"](#).
- \*4 When the screen display reverts using the [Function: Return] switch, the initial screen state is displayed, that is, the state in which no scrolling or block changes have been specified.
- \*5 It is possible to disable returning for screens that are displayed by an external command. Navigate to [System Setting] → [Unit Setting] → [General Setting] and select the [Return switch prohibited when switching the screen by an external command] checkbox on the [General Settings] tab. For details, refer to ["1.1 System Settings"](#).

## Transition

This item is available when [Screen Change-over] or [Overlap Control] is selected for [Function] in the switch settings.

\* **Transitions are disabled when performing screen changes or overlap control using a macro or from a PLC.**

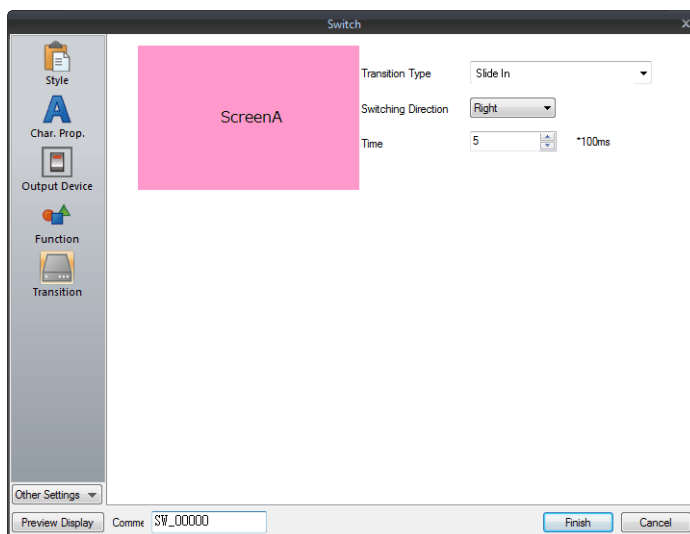

Item	Description
Transition Type	Specify the animation effect to use when the screen changes or an overlap is displayed.
Switching Direction (Right, Left, Up, Down)	Specify the switching direction.
Switching Type (Type 1, 2, 3, 4)	Specify the switching type.
Time*	Specify the duration in which to execute the transition.

\* The switching time range differs depending on the transition type.

- For [Function: Screen Change-over]:

Transition Type	Time	
Slide In	2 to 10 × 100 ms	
Slide In (with fade effect)		
Box In		
Box In (with fade effect)		
Fade In		
Slide Out		
Slide Out (with fade effect)		
Box Out		
Box Out (with fade effect)		
Slide		
Slide (with fade effect)		
Switch		5 to 10 × 100 ms
Jump		3 to 10 × 100 ms
Card Flip		5 to 20 × 100 ms
Gallery		

- For [Function: Overlap Control]:

Transition Type	Time
Slide (from outside screen)	2 to 10 × 100 ms
Slide (from outside screen, with fade effect)	
Slide (short distance, with fade effect)	2 to 5 × 100 ms
Fade	

## Macro

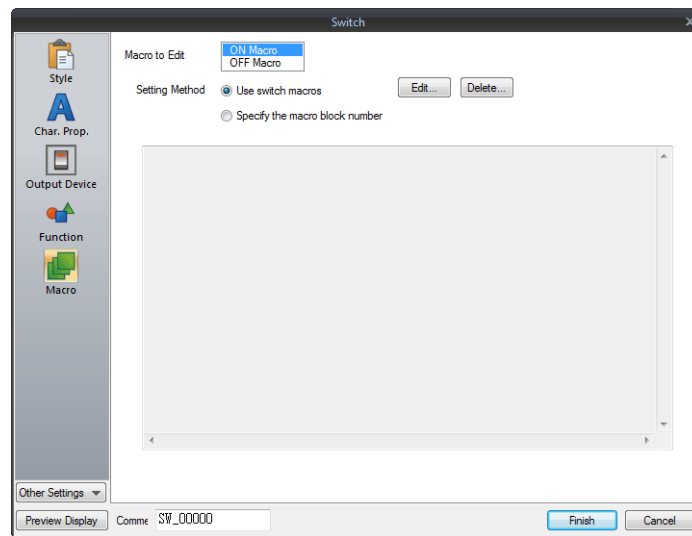

Item		Description
Macro to Edit		ON Macro Execute a macro once when the switch is pressed.
		OFF Macro Execute a macro once when the switch is released.
Setting Method	Use switch macros	Use a macro for the switch itself. Click the [Edit] button to register a macro.
	Specify the macro block number	Specify the macro registered to a macro block. If nothing is registered, click the [Edit] button to register a macro.

## Delay

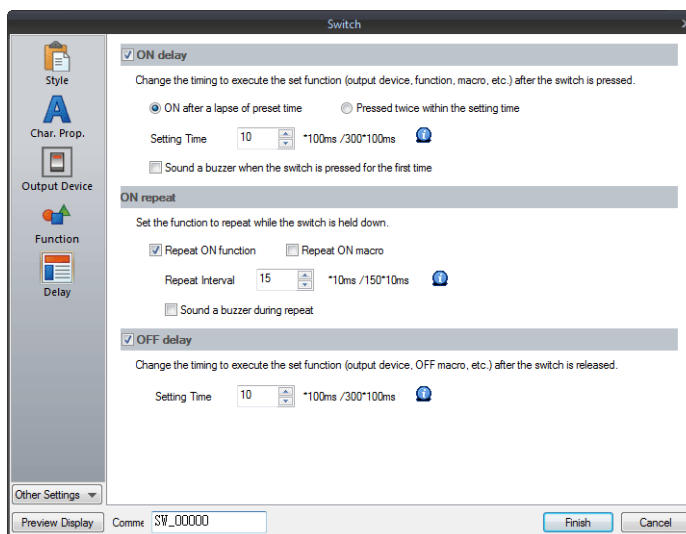

Item	Description
ON delay	Select this checkbox to specify a delay for when the switch is turned ON.
ON after a lapse of preset time (Setting Time: 1 to 300 × 100 ms)	The switch is activated for the function as specified for [Output Device], [Function], and [Macro] when the switch is held down for the specified time.
Pressed twice within the setting time (Setting Time: 10 to 300 × 100 ms)	The switch is activated for the function as specified for [Output Device], [Function], and [Macro] when the switch is pressed within the specified time interval. When the switch is pressed once, the frame of the switch starts blinking. The switch is activated when pressed again while blinking. If another switch is pressed or another screen is displayed while the switch frame is blinking, the switch operation is canceled. * If an overlap display is shown while the switch frame is blinking, the switch operation continues.
Sound a buzzer when the switch is pressed for the first time	Selected: Always sound a buzzer when the switch is pressed. Unselected: When this checkbox is unselected, a buzzer only sounds when the switch is activated after the ON delay time.
ON repeat <sup>*1</sup>	
Repeat ON function (Repeat interval: 15 to 150 × 10 ms)	When this checkbox is selected, the repeat function is added to the switch function.
Repeat ON macro (Repeat interval: 15 to 150 × 10 ms)	When this checkbox is selected, the repeat function is added to the switch ON macro.
Sound a buzzer during repeat	Select this checkbox to sound a buzzer when a repeat operation is executed.
OFF delay <sup>*2</sup> (Setting Time: 1 to 300 × 100 ms)	Select this checkbox to specify a delay for when the switch is turned OFF. A switch OFF operation (output device memory, OFF macro, etc.) will be processed at the conclusion of the specified time after the switch has been released. * The OFF delay setting can be configured for a maximum of eight switches on a single screen.

<sup>\*1</sup> If the [Repeat ON function] checkbox is selected and the ON macro repeat function is also set (at \$s64 to 66), the repeat operation of the ON macro will be executed first when the switch is pressed.

<sup>\*2</sup> When the screen has a switch currently performing an OFF delay operation, the screen cannot be switched (no switch operation acceptable) until the OFF delay operation is completed. Likewise, when an overlap display has a switch currently performing an OFF delay operation, the overlap display cannot be switched or cleared until the OFF delay operation is completed.

## Interlock

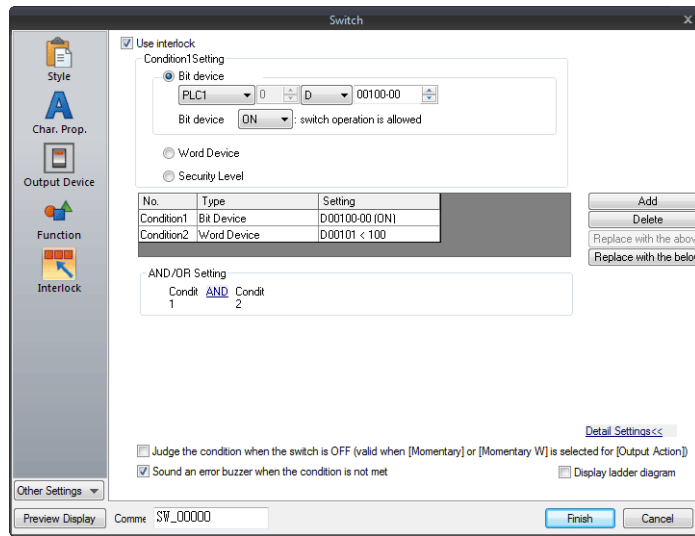

Item	Description	
Use interlock	Select this checkbox to enable the interlock function for the switch. Click [Add] to set up to 5 conditions that must be satisfied for the interlock to activate.	
Condition Setting	Bit device	Set the interlock bit address.  Bit device "ON": switch operation is allowed When [Bit device] is OFF, switch operation is prohibited. When [Bit device] is ON, switch operation is allowed.  Bit device "OFF": switch operation is allowed When [Bit device] is OFF, switch operation is allowed. When [Bit device] is ON, switch operation is prohibited.
	Word Device	Set the comparison condition expression of the interlock device memory.  Data Length: Set the data length of the condition value. 1-Word/2-Word  Constant Display Type: Set the format of the comparison condition expression. [DEC +/-]/[DEC]/[BCD]  Comparison condition expression: Set a comparison sign, value, and device memory as the conditions for comparison.
	Security Level	Used in conjunction with the security function. Allow users of levels higher than the set level to operate the switch. For details on security functions, refer to "5 Security" in the V9 Series Reference Manual 2.
AND/OR Setting	When two or more conditions are set for activating the interlock, set whether to perform AND and OR operations on the conditions.	
Detailed Settings	Judge the condition when the switch is OFF *1	This setting is available when [Momentary/Momentary W] is selected for [Output Action]. Set whether the system judges the conditions for interlock activation when the switch is released (i.e. when your finger is released from the switch).  Unselected: The system does not judge the conditions when the switch is OFF.  Selected: The system judges the conditions even when the switch is OFF. If the conditions are not satisfied, the switch will not be turned OFF even when your finger is released.
	Sound an error buzzer when the condition is not met	Set whether an error buzzer sounds when the switch is pressed and the conditions are not satisfied.  Unselected: A buzzer does not sound.  Selected: A buzzer will sound.
Display ladder diagram	Select this checkbox to display the configured conditions for interlock activation as a ladder diagram.	
Display setting details	Select this checkbox to configure condition settings on the ladder diagram.	

\*1 Example of operation when the switch is OFF

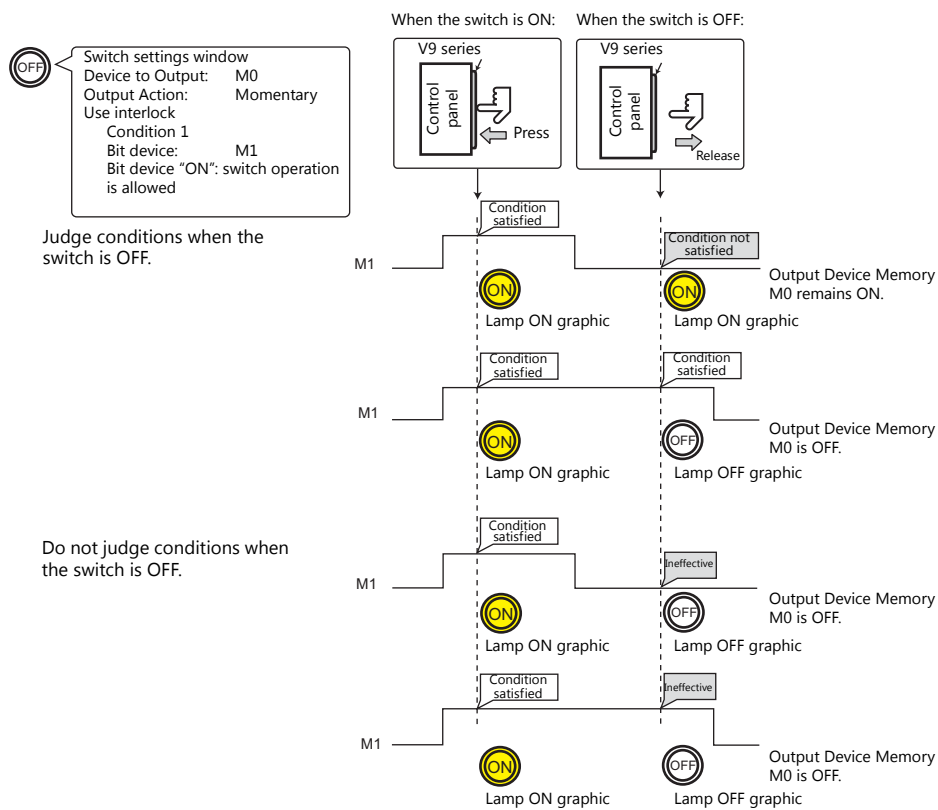

**Display when switches are disabled**

When the [Gray out interlocked switches] checkbox at [System Setting] → [Unit Setting] → [General Setting] is selected, switches that do not satisfy the interlock conditions can be displayed grayed out.

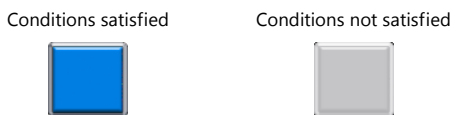

## Message Box

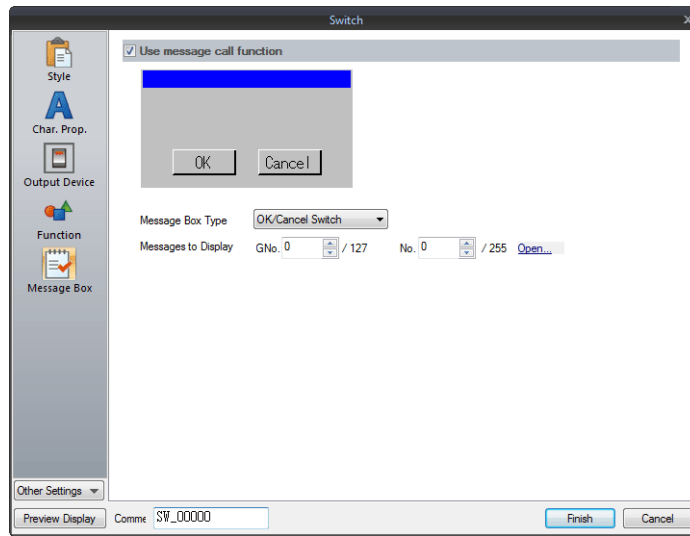

Item	Description
Use message call function	Select this checkbox to automatically display a message dialog box when the switch is pressed. When [OK] is pressed, the switch is activated for the function as specified for [Device to Output], [Function], and [Macro]. When [Cancel] is pressed, no operations are performed and the message dialog box closes.
Message Box Type	OK/Cancel Switch Use a message dialog box that displays an [OK] and [Cancel] switch. OK Switch Use a message dialog box that only displays an [OK] switch.
Messages to Display	Reference one line of the message registered in the [Message] window. A maximum of 96 one-byte characters (48 two-byte characters) can be displayed.  Click [Open] to display the [Message Edit] window. For details on editing messages, refer to the V9 Series Operation Manual.

- While a message dialog box is displayed, no switch operations other than those in the message dialog box are accepted (except for the function switches).
- If the screen is changed while a message dialog box is displayed, this has the same effect as pressing [Cancel].

## Show/Hide

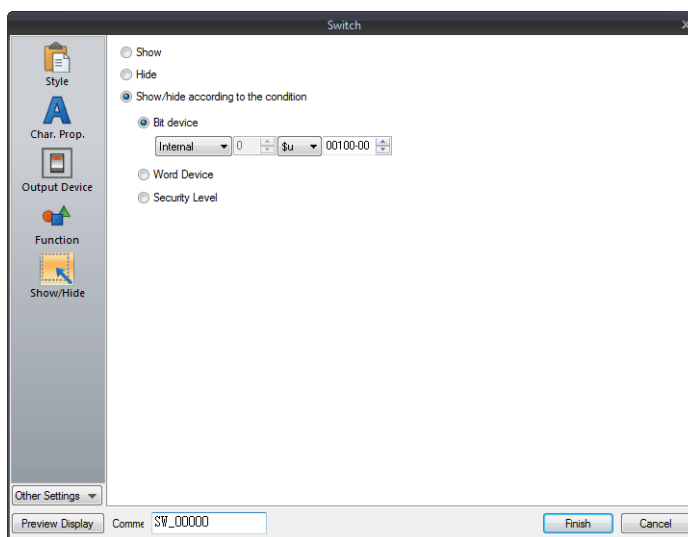

Item		Description	
Show		Display the numerical data display on the screen.	
Hide		Do not display the numerical data display on the screen.	
Show/Hide according to the condition	Bit device	Display the switch if the device memory bit is ON and hide the switch if the device memory bit is OFF.	
	Word Device	Show the switch if the condition is satisfied and hide the switch if the condition is not satisfied.	
		Constant Display Type	Select the data type of the conditional expression. [DEC+ -]/[DEC]/[BCD]
	Condition expression	Set a comparison sign, value, and device memory address as the conditions for comparison.	
Security Level		This setting is available when using the security function. The "show/Hide" attribute can be controlled according to the user's login level. For details, refer to "5 Security" in the V9 Series Reference Manual 2.	



## Detail

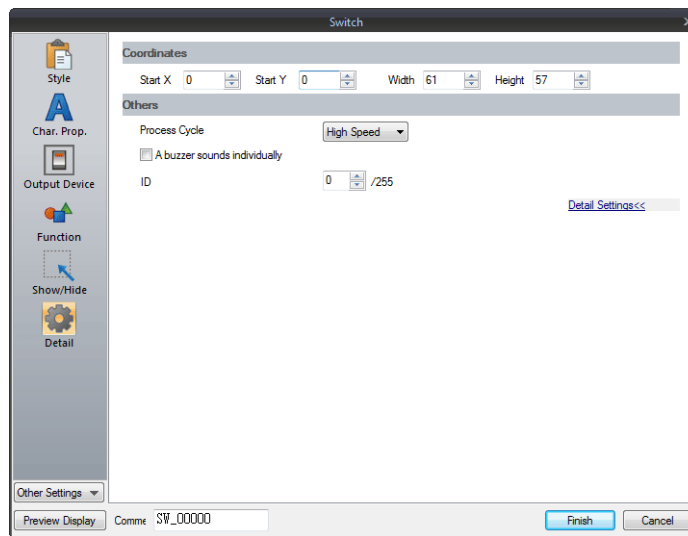

Item		Description
Coordinates	Start X/Start Y	Set the display position of the switch using X and Y coordinates.
	Width/Height	Set the size of the switch by specifying width and height.
Others	Process Cycle	Set a cycle for the V9 series to read PLC data while the V9 series is communicating with the PLC. For details, refer to "1.2 Process Cycle".
	A buzzer sounds individually	Unselected: This depends on the setting configured in [System Setting] → [Unit Setting] → [Buzzer]. Selected A buzzer sound is set for each switch. Standard/Short/Continuous/Error *1/OFF
	Save an operation log	Used in conjunction with the operation log. For details, refer to "4 Operation Log" in the V9 Series Reference Manual 2.
	ID (0 - 255)	Set the ID. For details on IDs, refer to the V9 Series Operation Manual.

\*1 When the buzzer is set to OFF in [System Setting] → [Unit Setting] → [Buzzer], the setting here is disabled (i.e. buzzer OFF).

## 3.1.4 Basic Function of Switches

### List of Functions

If the [Display All] checkbox is selected next to [Function] in the switch settings, all of the switch functions are displayed for selection.

When nothing is listed in the "Linked Part" column of the table, the switch activates alone with the set function. When one or more functions are listed in the "Linked Part" column, the switch will not perform its set function unless a link is established with a corresponding part (i.e. the IDs of the switch and corresponding part must match).

For details, refer to the relevant pages.

### Standard

Name	Description	Linked Part	Refer to
Standard	Set the bit number of the specified device memory ON/OFF.	–	–
Screen Change-over	Change to the screen of the specified screen number.	–	–
Hard Copy	Print the currently displayed screen image.	–	<a href="#">page 16-15</a>
Overlap Control	Control normal/call/multi-/global overlap display.	–	<a href="#">page 2-1</a>
Return	Return to the previous screen	–	–
Reset	Clear logging and alarm data.	Alarm Trend	<a href="#">page 8-1</a> <a href="#">page 7-1</a>
Word Operation	Perform operations on device memory data.	–	<a href="#">page 3-9</a>
Item Select	Act as an entry selection switch if data is placed in the same switch.	Entry	<a href="#">page 6-32</a>
Language changeover	Change the display language.	–	*1
Switching to Local Mode	Change to Local mode.	–	–
+Block	Increment the display block by one.	Message mode Graphic Alarm Trend Memo Pad JPEG	<a href="#">page 12-1</a> <a href="#">page 11-1</a> <a href="#">page 8-1</a> <a href="#">page 7-1</a> <a href="#">page 13-1</a> *1
– Block	Decrement the display block by one.		
Roll Up	Scroll up.	Message mode	<a href="#">page 12-1</a>
Roll Down	Scroll down.	Alarm Trend	<a href="#">page 8-1</a> <a href="#">page 7-1</a>
Block Call	Change the display block.	Message mode Graphic Memo Pad	<a href="#">page 12-1</a> <a href="#">page 11-1</a> <a href="#">page 13-1</a>
Mode	Display messages that correspond to functions on the switch.	Message mode Alarm	<a href="#">page 12-1</a> <a href="#">page 8-1</a>
Occupy	Make a 1:1 connection with the PLC (multi-link connection only).	–	–
Storage Format (Buffer)	Format the sampling or logging file on the storage device.	–	–
Storage Removal	Stop access to the storage device.	–	<a href="#">page 3-24</a>
Ladder Monitor	Display the ladder monitor screen.	–	*2
Operation Log Viewer Display	Display the operation log viewer.	–	*1
Video Player Display	Display the video player.	–	*1
PDF Viewer Display	Display the PDF viewer.	–	*1

\*1 For details, refer to the V9 Series Reference Manual 2.

\*2 For details, refer to the V9 Series Ladder Monitor.

## Entry

Name	Description	Linked Part	Refer to		
Character Input	Enter text onto switches.	Entry (DELETE key available for alarm usage)	page 6-1		
Write	Write the entry data to the device memory.				
Clear	Clear the entry data.				
Toggle Sign	Invert the entered sign (for numerical input).				
Space	Enter a one-byte space (for character input).				
Back Space	Delete the character to the left of the cursor <sup>*1</sup> .				
Delete	Delete the character at the cursor position <sup>*1*2</sup> .				
+1	Increment the number at the cursor position by one (for numerical input).				
-1	Decrement the number at the cursor position by one (for numeric input).				
Add	Add a set number to the number display at the cursor position.				
Subtraction	Subtract a set number from the number display at the cursor position.				
Cancel	Restore the initial display state during entry operation.				
LFT	Move the cursor left <sup>*2</sup> .				
RGT	Move the cursor right <sup>*2</sup> .				
UP	Move the cursor to the previous option (-1).				
DW	Move the cursor to the next option (+1).			Entry	page 6-1
>>	Move to the next screen page (+1)				
<<	Move to the previous screen page (-1).				
Graphic Library	Change characters by reading a graphics library.				
Conversion of Kanji	Select the Kanji mode.				
80 Compatible HEX Key	Use when converting GD-80 series screen programs				
80 Compatible HEX Key Change					
Max. Value Entry	Display the maximum value at the entry display position.				
Min. Value Entry	Display the minimum value at the entry display position.				
Multi-char. Input	Change the text on the switch.				
Switching (Entry Mode Change)	Change the text entry mode (when the Japanese conversion function is used).				
Switching (1-byte/2-byte Char. Change)	Change between one-byte and two-byte characters (when the Japanese conversion function is used).				
Switching (Caps Lock)	Change between uppercase and lowercase characters (when the Japanese conversion function is used).				
Direct Input	Perform direct text input (when the Japanese conversion function is used).				
Word Edit	Edit registered words (when the Japanese conversion function is used).				
Word Registration	(Not used.) * <b>Register new words with a [Word Edit] switch.</b>				
Char. Switching (+)	Increment the character entry switch by one.				
Char. Switching (-)	Decrement the character entry switch by one.				

\*1 The decimal point and signs cannot be deleted from numerical data displays.

\*2 For numerical displays, the [Allow to use Insert/DELETE keys when entering values] checkbox must be selected on the [General Settings] tab of the [Unit Setting] window, which is displayed by navigating to [System Setting] → [Unit Setting]. The above setting applies to the entry modes of all screens.

## Logging

Name	Description	Linked Part	Refer to
Graph Return	Return to the latest logging data.	Trend	page 7-1
Print	Print the logging information.		
Zooming in	Zoom in on a trend graph.		
Zooming out	Zoom out of a trend graph.		
File Select	Display the file selection window.		

## Alarm

Name	Description	Linked Part	Refer to
Graph Return	Return to the latest monitoring data.	Alarm	<a href="#">page 8-1</a>
Display Change-over	Change the display between date display and time display.		
Print	Print the alarm information.		
Change Display Order	Change the display order between order of occurrence and newest first.		
Acknowledge	Display the acknowledgement time of the alarm.		
File Select	Display the file selection window.		
Filter Display	Display the filter window.		

## Memo Pad

Name	Description	Linked Part	Refer to
Pen Color	Select the pen color.	Memo Pad	<a href="#">page 13-1</a>
Pen Size	Select the pen thickness.		
Line	Draw a straight line.		
Delete Area	Delete the selected area of the memo pad.		
Delete All	Delete all memo pads on the screen.		

## Table Data

Name	Description	Linked Part	Refer to
Cursor Movement to Right	Move the cursor right within the table.	Table Data Display	<a href="#">page 5-33</a>
Cursor Movement to Left	Move the cursor left within the table.		
Table Move +	Move the table in the positive direction.		
Table Move –	Move the table in the negative direction.		

## Digital Switch

Name	Description	Linked Part	Refer to
Digital Switch +	Increment the selected digit by one.	Numerical Display	<a href="#">page 3-23</a>
Digital Switch –	Decrement the selected digit by one.		
Digital Switch Sign Inversion	Inverse the sign of the numerical data display.		

## Video

Name	Description	Linked Part	Refer to
Pause	Stop video playback.	Network camera display	*1
Restart	Resume video playback.		

\*1 For details, refer to the V9 Series Reference Manual 2.

## JPEG

Name	Description	Linked Part	Refer to
File Delete	Delete the JPEG file currently displayed or recipe file currently selected.	JPEG	*1
File Call	Load the JPEG file of the specified number.		
JPEG Search	Set an increment/decrement value for JPEG file selection.		

\*1 For details, refer to the V9 Series Reference Manual 2.

## Recipe

Name	Description	Linked Part	Refer to
Recipe Data Save	Save the specified recipe data.	-	<a href="#">page 15-1</a>
Recipe Data Load	Load the specified recipe data.		
Recipe Data Delete	Delete the specified recipe data.		

## Security

Name	Description	Linked Part	Refer to
Log In	Change the security level.	-	*1
Log Out	Change the security level to "0".		

\*1 For details, refer to the V9 Series Reference Manual 2.

## Network Camera Display

Name	Description	Linked Part	Refer to
Step Up	Point the camera up.	Network camera display	*1
Step Down	Point the camera down.		
Step Left	Point the camera left.		
Step Right	Point the camera right.		
Zoom In	Zoom in on the camera image.		
Zoom Out	Zoom out of the camera image.		
Focus Far	Focus the camera on a distant point.		
Focus Near	Focus the camera on a nearby point.		

\*1 For details, refer to the V9 Series Reference Manual 2.

## Switch Function Examples

### Digital Switch

#### Usage example

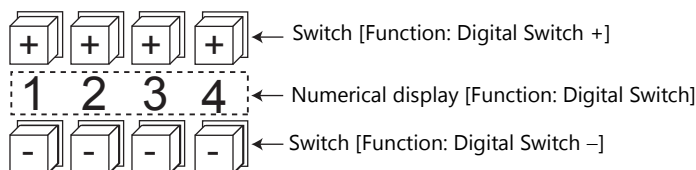

- Switch
  - Function

Item	Description
Digital Switch +	Target digits (1 to 17) The selected digit is incremented by one.
Digital Switch -	Target digits (1 to 17) The selected digit is decremented by one.
Digital Switch Sign Inversion	- Inverse the sign of the numerical data display

- [Detail] → [Detail settings]  
ID: Same as the numerical data display part.
- Numerical Display
  - [Function: Digital Switch]  
Carryover to higher/lower digits: When selected, carryover to higher/lower digits is performed. When not selected, only the specified digit changes.
  - [Detail] → [Detail settings]  
ID: Same as the switch.

Without carryover:

- Without sign or with "+" sign  
Pressing the [+] key on the first digit changes "129" → "120".  
Pressing the [-] key on the first digit changes "120" → "129".

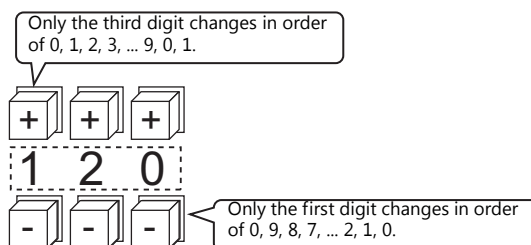

- With "-" sign  
Pressing the [+] key on the first digit changes the display as shown below.  
"-008" → "-009" → "000" → "001" → "002"  
Change the sign using a switch ([Function: Digital Switch Sign Inversion]).

With carryover:

- Without sign or with "+" sign  
Pressing the [+] key changes "129" to "130".  
Pressing the [-] key changes "120" to "119".
- With "-" sign  
Pressing the [+] key changes "-129" to "-128".  
Pressing the [-] key changes "-129" to "-130".

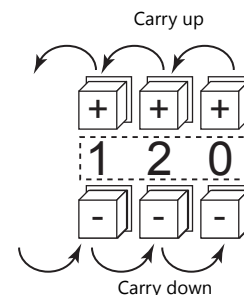

#### Notes

- Maximum and minimum values can be set when [Alarm] is selected for [Operation/Alarm].
- [Word Operation] and [Scaling] can be used.
- If multiple numerical data display parts ([Function: Digital Switch]) of the same ID exist, the part that is placed first is targeted for operation.

## Storage Removal (Stopping Access to a Storage Device)

The switch lamp status changes as shown in the following table. Information on the switch status is stored at \$s500 in the system device memory.

Lamp	Storage Removal	Storage Access Status
OFF	Prohibited	Normal access
Blinking ON/OFF	Prohibited	Data writing triggered by switch turning ON
ON	Permitted	Access stopped

\* If the [Upon storage removal] checkbox is selected in the storage output settings of the alarm server or logging server, alarm/logging data is output in CSV format.

### Notes

- The [Storage Removal] switch stops access to all connected storage devices (SD card and USB storage devices). To individually remove an SD card or USB storage device, perform removal from the system menu. For details, refer to the V9 Series Troubleshooting/Maintenance Manual.
- When intending to cancel the switch ON status (with access stopped) and start accessing the storage device, press the switch again.
- If the screen is changed when the switch is ON, the state of the storage device does not automatically return to the accessing state.  
Always press the switch to change it to the OFF state (accessing).
- The lamp device memory address specified for the switch becomes unavailable.

### 3.1.5 Flowchart

#### When the Switch is ON (Pressed)

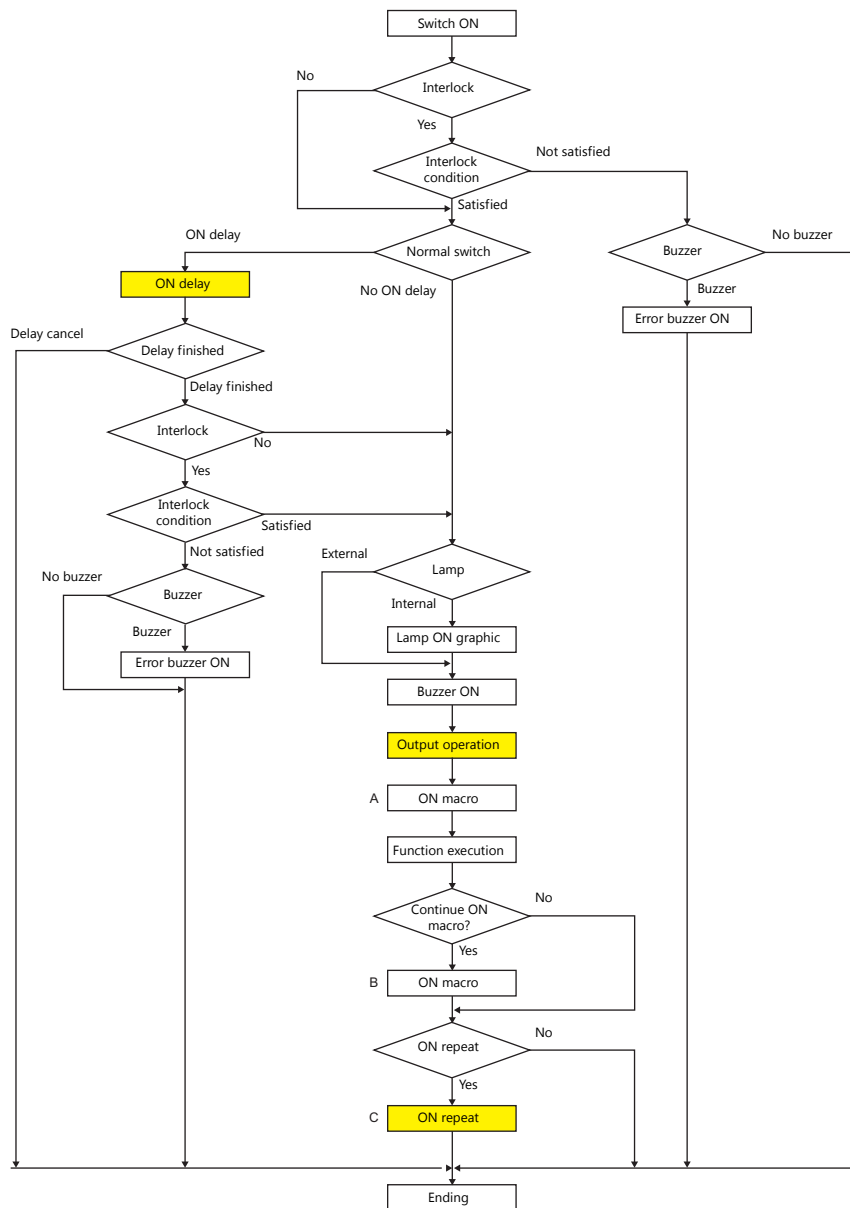

- \*1 [Output Action] or [Macro] should be selected for execution.
- \*2 Macro B starts after macro A is finished with the "SWRET" command.  
For details on macro commands, refer to the V9 Series Macro Reference Manual.
- \*3 The switch function is executed after the ON macro is executed. However, the "SET\_SCRN," "SET\_MOVLP," "OVL\_P\_SHOW," and "OVL\_P\_POS" commands are executed after the switch function has been executed.
- \*4 Operation "C" is repeated until the switch is turned OFF (released).





## ON delay

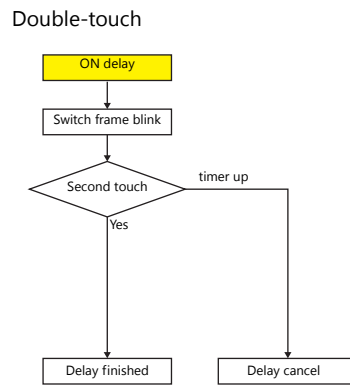
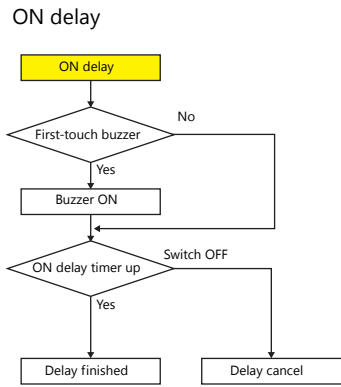

### Message dialog box

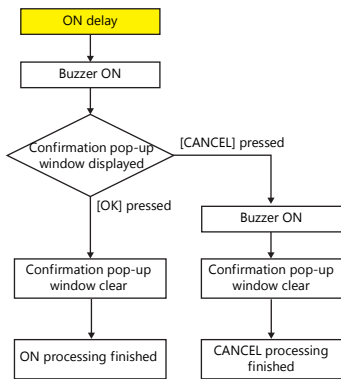

### ON delay + message dialog box

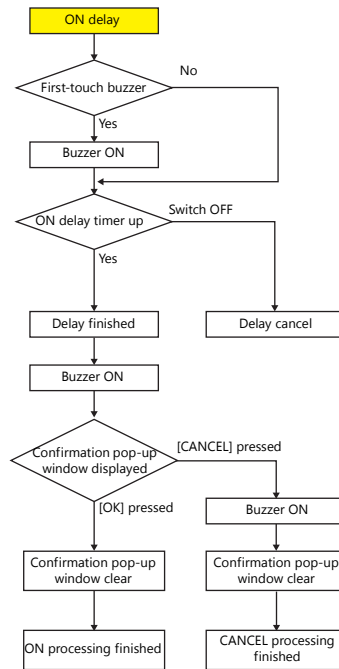

## Output action

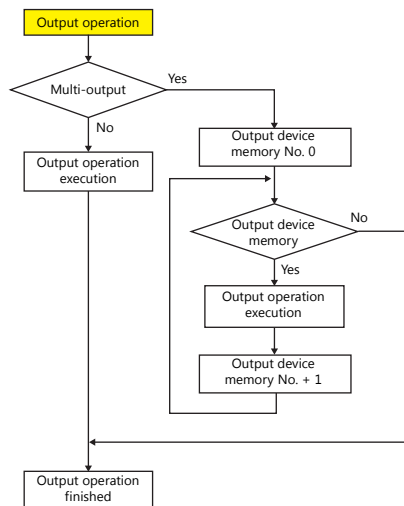

## ON repeat

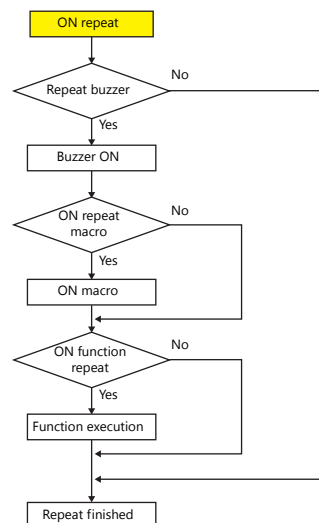

## When the Switch is OFF (Released)

### Set, reset, alternate

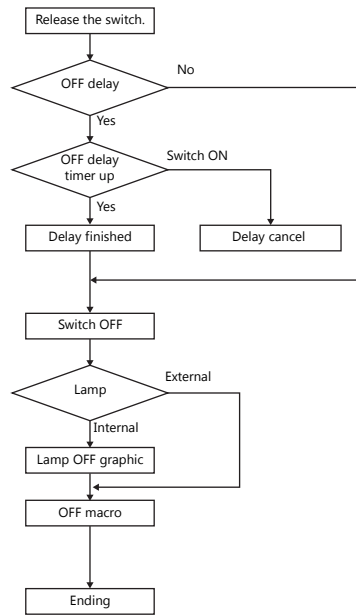

### Momentary, momentary W

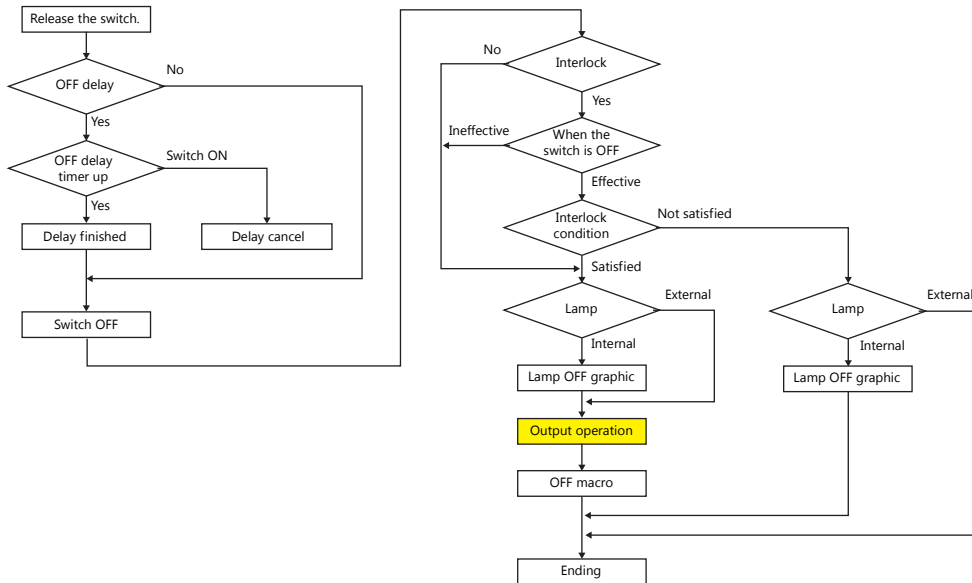

\* For details on [Output Action] settings, refer to “Notes on [Momentary] and [Momentary W] operation” page 3-8.

## 3.1.6 Coordinate Output

The current touch switch information is output to \$s900 to 902 of the system device memory. This information is useful when linking to an image processing device.

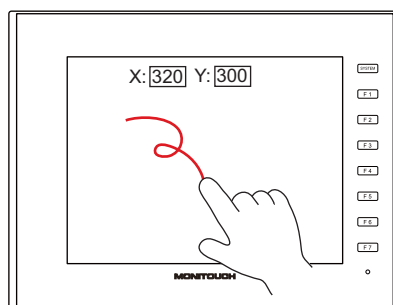

- \$s900  
Touch switch status

15	14	13	12	11	10	09	08	07	06	05	04	03	02	01	00
0	0	0	0	0	0	0	0	0	0	0	0	0	0	0	0

Not used

0: Switch OFF  
1: Switch ON

- \$s901  
X coordinate (absolute)
- \$s902  
Y coordinate (absolute)

### 3.1.7 Notes



Do not use switches where they could cause injury to people or damage machinery. Moreover, do not use switches as emergency switches.

## Placement

### Minimum Switch Size and Maximum Number of Switches

- Minimum size: 2 pixels × 2 pixels  
(For safety reasons, however, using switches greater than 18 pixels × 14 pixels is recommended.)
- Maximum number of switches: 4096  
\* This includes scroll bars and slide switches.

### Placing Switches Overlaying Other Switches



Do not overlay one switch on another switch.

- If switches are overlaid, the top switch will always be enabled and the bottom switch disabled.

## Switch Area

The operable area that is sensitive to screen presses is basically identical to the switch part area. However, the operable area may differ depending on the part type, placement method, and enlargement or reduction.

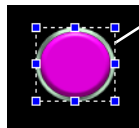

Part area

Check the action area as described below.

## Location of settings

[View] → [Display Environment] → [Display] tab → [Display Area] checkbox

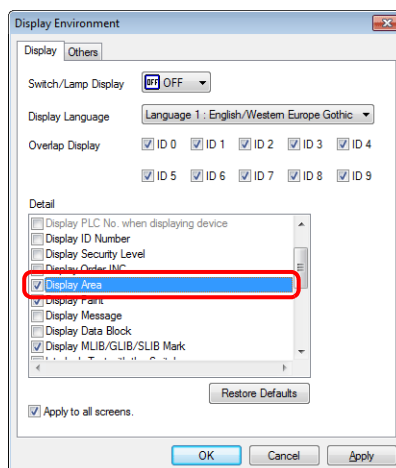

When the [Display Area] checkbox is selected, a dotted box is shown around each placed switch part as shown below. This dotted box indicates the switch's operable area. Pressing within the switch's operable area will activate the switch. The outline of each switch part is called the "part area" of the switch. Pressing anywhere outside of this area does not activate the switch.

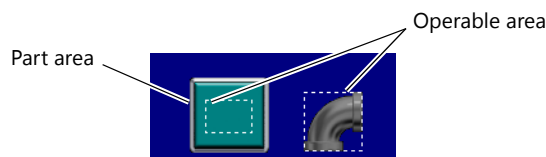

## 3.2 Scroll Bars

### 3.2.1 Overview

Scroll bars can be used to display portions of messages or JPEG images that lie off screen.

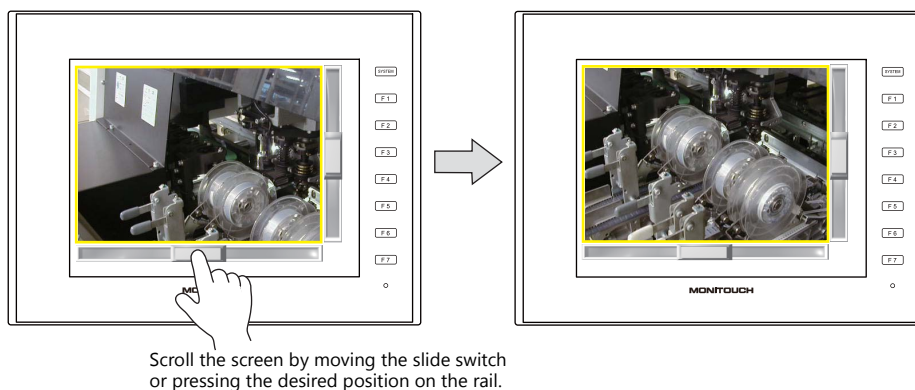

#### Position to press and data write timing

- The scroll bar operates when either the slide switch or rail is pressed.
- Writing of a value occurs when the slide or rail is released.

#### Conceptual diagram of slide switch movement

- The slide switch moves together with your finger during movement.

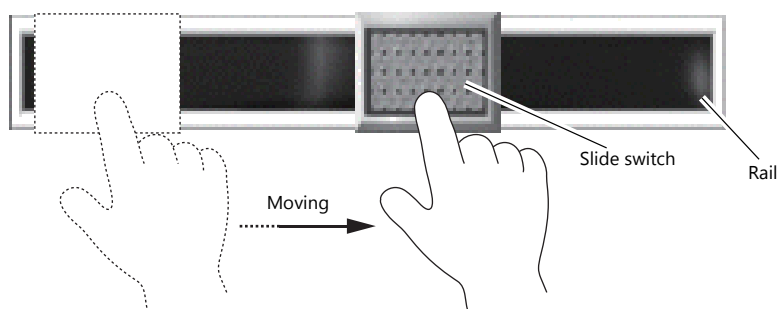

\* The V9 series allows scrolling by dragging the display area instead of using a scroll bar.  
For details, refer to "7.1 Enlarging and Scrolling Screens" in the V9 Series Reference Manual 2.

### Applicable Items

Item	Scroll Direction
JPEG	Vertical and horizontal
Alarm sub-display *1	Vertical and horizontal
Message Mode	Vertical and horizontal
Trend graph/sampling	Vertical or horizontal *2

\*1 The scroll bar is not supported for other alarm items.

(Scrolling is performed automatically for long messages.)

\*2 The scrolling direction depends on the [Direction] setting in the [Trend Graph] window.

[↑] [↓]: vertical scrolling, [→] [←]: horizontal scrolling

### 3.2.2 Setting Examples

Scroll bars can be added to screens that display JPEG images.

\* For details on JPEG display settings, refer to "1.1 JPEG Display" in the V9 Series Reference Manual 2.

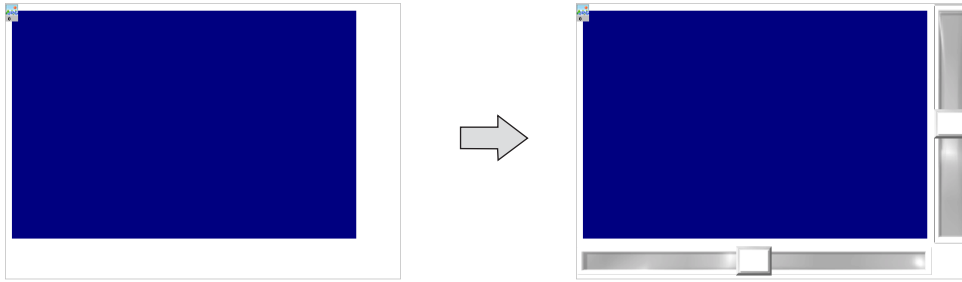

1. Click [Parts] → [Catalog] to display the catalog window.  
Configure the following settings and drag and drop a vertical scroll bar onto the screen.

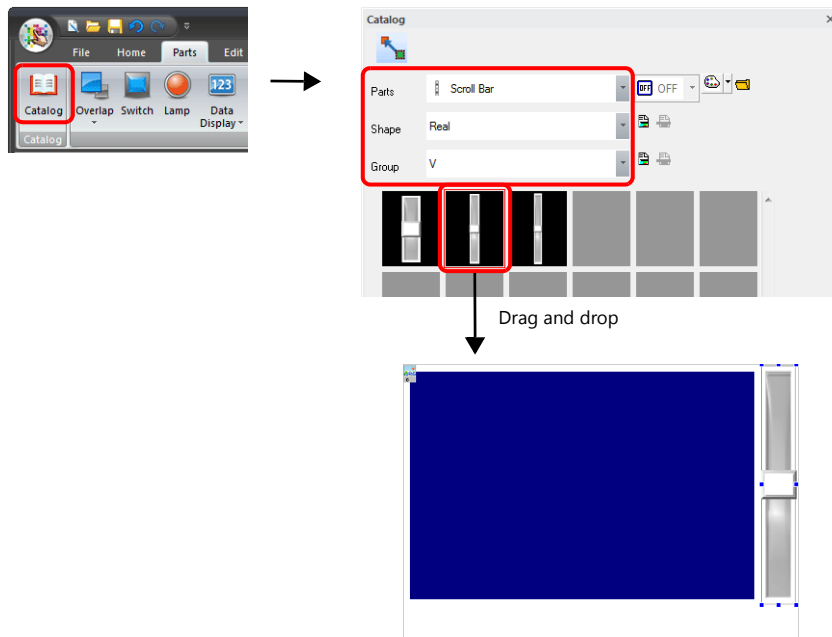

2. Double-click on the scroll bar to display the settings window.  
Configure the [Output Setting] settings as shown below.

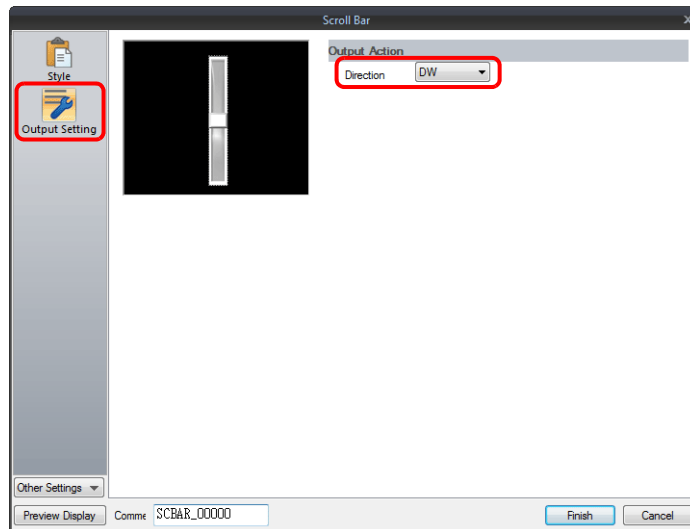

- Click [Other Settings] → [Detail].  
Click [Detail] → [Detail Settings], link [ID] to the ID of the JPEG display, and then click [Finish].

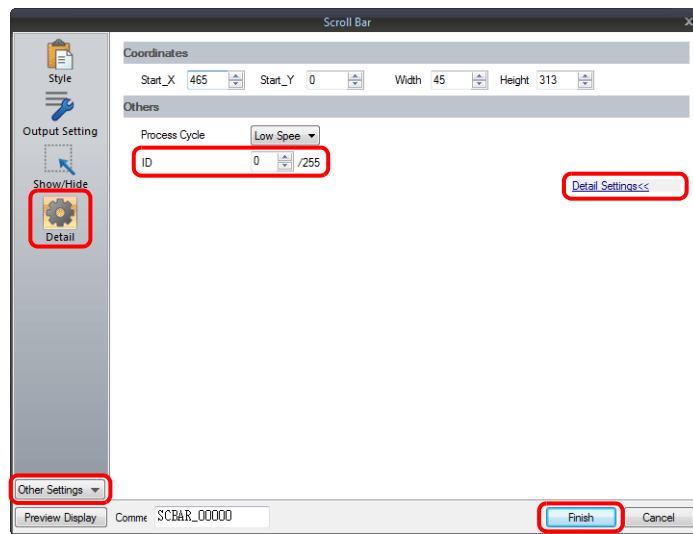

- Drag and drop a horizontal scroll bar onto the screen from the catalog window in the same manner as step 1.

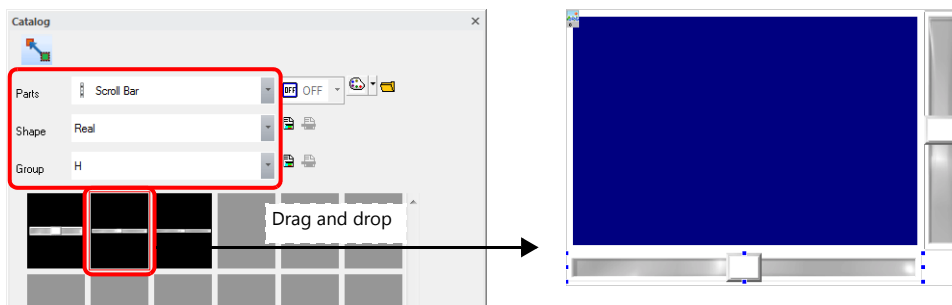

- Double-click on the scroll bar to display the settings window.  
Configure the [Output Setting] settings as shown below.

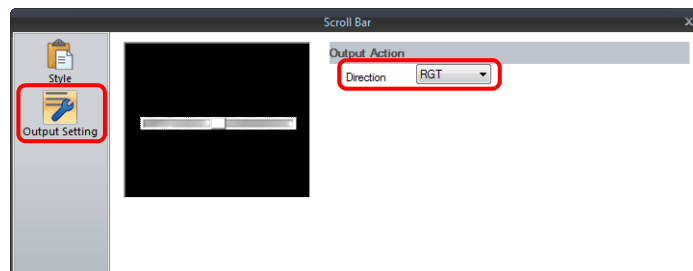



6. Click [Other Settings] → [Detail].  
Click [Detail] → [Detail Settings], link [ID] to the ID of the JPEG display, and then click [Finish].

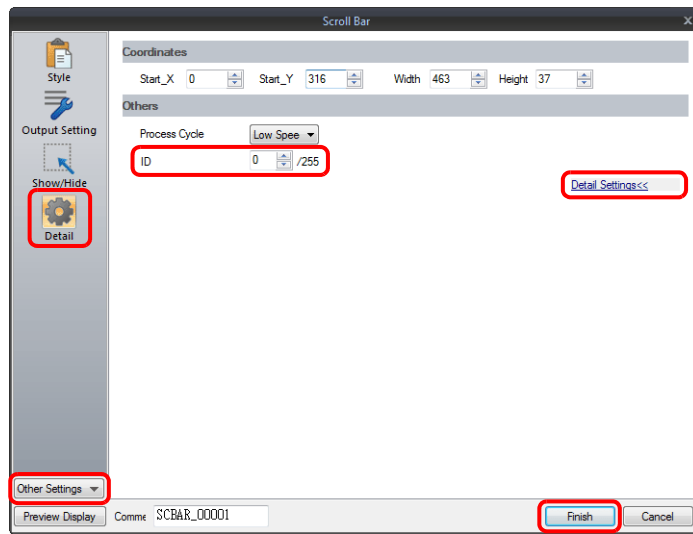

This completes the necessary settings.

### 3.2.3 Detailed Settings

#### Style

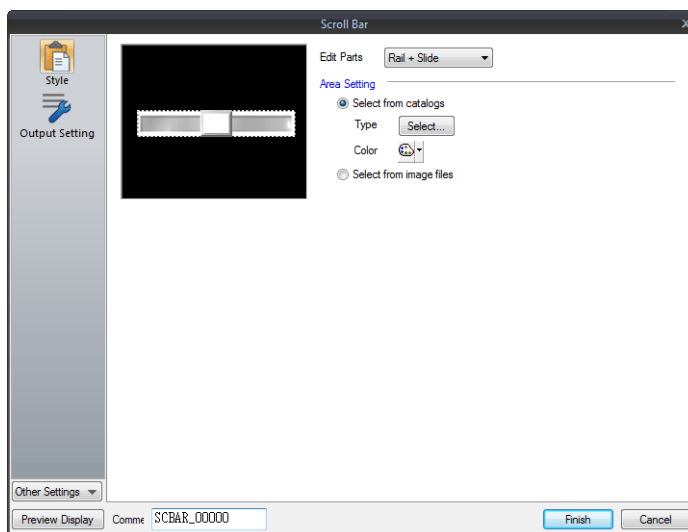

Item		Description
Edit Parts		Select the parts to edit (rail/slide).
Area Setting	Select from catalogs	Select the part design of each pattern. After selecting the part, select the part color.
	Select from image files	Select a PNG file.

#### Output Setting

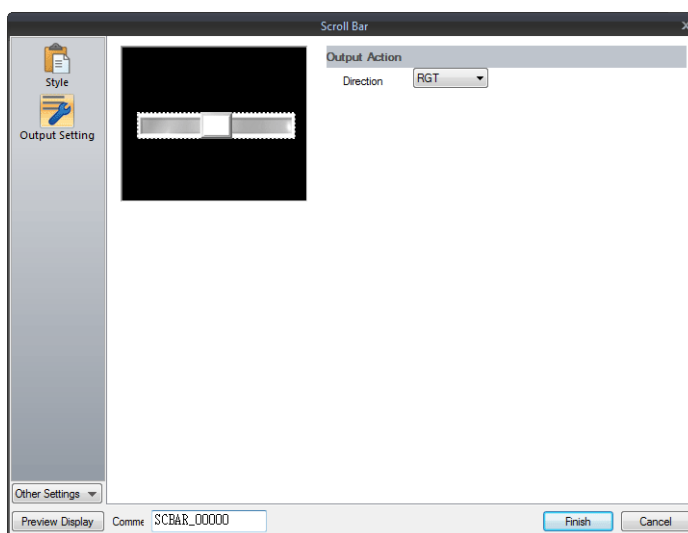

Item		Description
Output Action	Direction (RGT, LFT, UP, DW)	Select the scrolling direction.

## Show/Hide

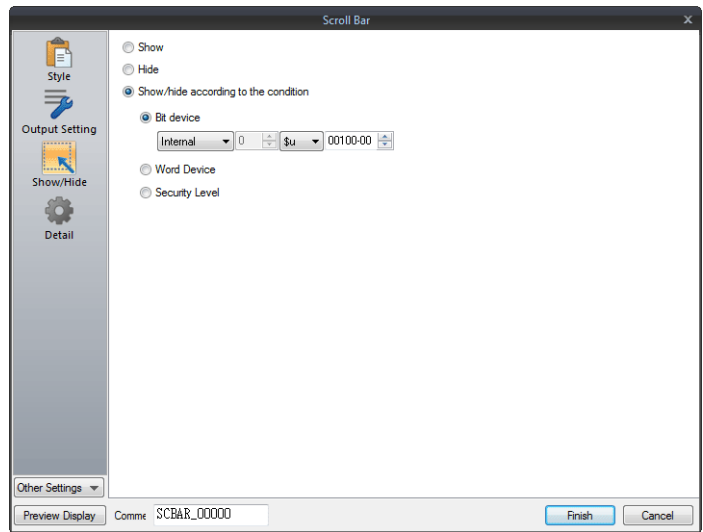

Item		Description			
Show		Display the numerical data display on the screen.			
Hide		Do not display the numerical data display on the screen.			
Show/Hide according to the condition	Bit device	Display the switch if the device memory bit is ON and hide the switch if the device memory bit is OFF.			
	Word Device	Show the switch if the condition is satisfied and hide the switch if the condition is not satisfied.			
		<table border="1"> <tr> <td>Constant Display Type</td> <td>Select the data type of the conditional expression. [DEC+ -]/[DEC]/[BCD]</td> </tr> <tr> <td>Condition expression</td> <td>Set a comparison sign, value, and device memory address as the conditions for comparison.</td> </tr> </table>	Constant Display Type	Select the data type of the conditional expression. [DEC+ -]/[DEC]/[BCD]	Condition expression
	Constant Display Type	Select the data type of the conditional expression. [DEC+ -]/[DEC]/[BCD]			
Condition expression	Set a comparison sign, value, and device memory address as the conditions for comparison.				
Security Level	This setting is available when using the security function. The "show/Hide" attribute can be controlled according to the user's login level. For details, refer to "5 Security" in the V9 Series Reference Manual 2.				

## Detail

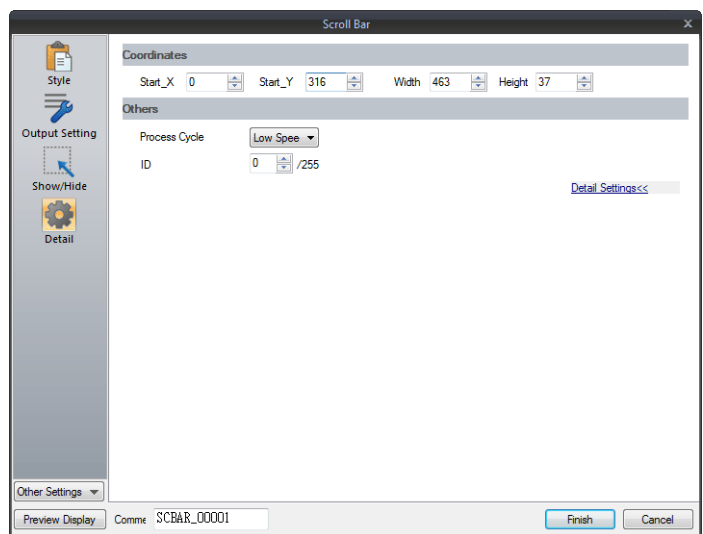

Item		Description
Coordinates	Start X/Start Y	Set the display position of the scroll bar using X and Y coordinates.
	Width/Height	Set the size of the scroll bar by specifying width and height.
Others	Process Cycle	Set a cycle for the V9 series to read PLC data while the V9 series is communicating with the PLC. For details, refer to "1.2 Process Cycle".
	ID (0 - 255)	Set the ID. For details on IDs, refer to the V9 Series Operation Manual.

### 3.2.4 Notes

---

- A maximum of 4096 parts (including switches and slide switches) can be placed on one screen.
- Scrolling is performed in pixel units.
- If multiple scroll bars are placed that have the same ID and are not linked to other items, the scroll bar in the foreground takes effect.

## 3.3 Slider Switch

---

Slider switches are used in conjunction with numeric data entry.  
For details on slider switches, refer to "[6.1 Numerical Data Entry](#)".

## **4 Lamp**

---

# 4.1 Overview

- The displayed patterns of lamps are switched in response to data changes in the lamp device memory. There are lamps called "bit lamps" that are switched according to bit setting (ON) and resetting (OFF) and "word lamps" that are switched according to the values placed in device addresses.

- Bit lamp

Lamp device memory: M19

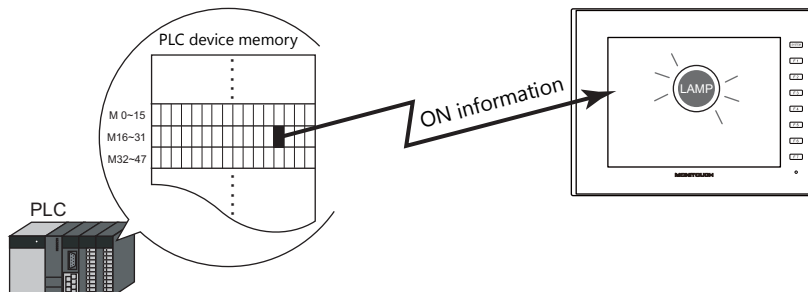

For example settings, refer to "Using Bit Lamps" page 4-2.

- Word lamp

Lamp device memory: D100

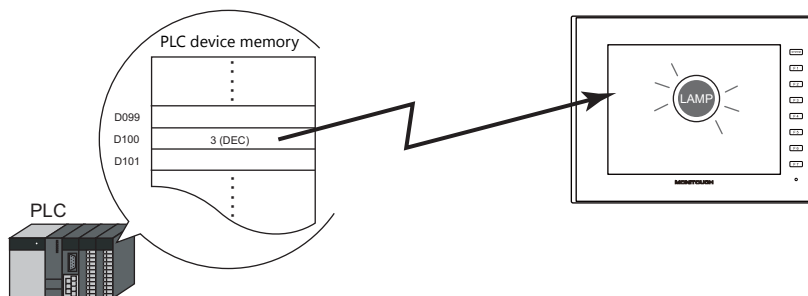

- Colors can be set on a pattern-by-pattern basis. For a [Draw Mode: REP] lamp, the text on the lamp can also be set for each pattern.

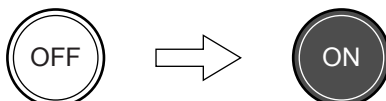

- A single lamp can change between a maximum of 128 patterns.

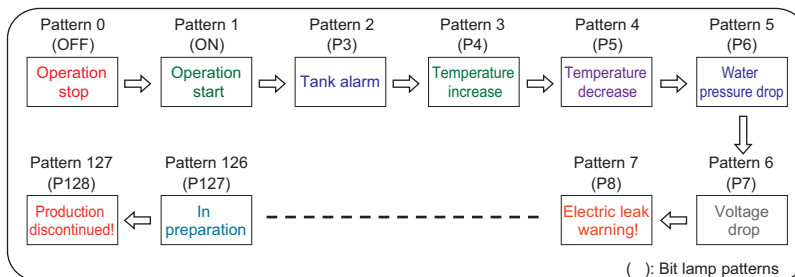

For example settings, refer to "Placing 128 Pattern Lamps" page 4-3.

## 4.2 Setting Examples

### Using Bit Lamps

When the M19 bit of the PLC device memory is ON, the lamp turns on, and when the M19 bit is OFF the lamp turns off.  
Lamp device memory: M19

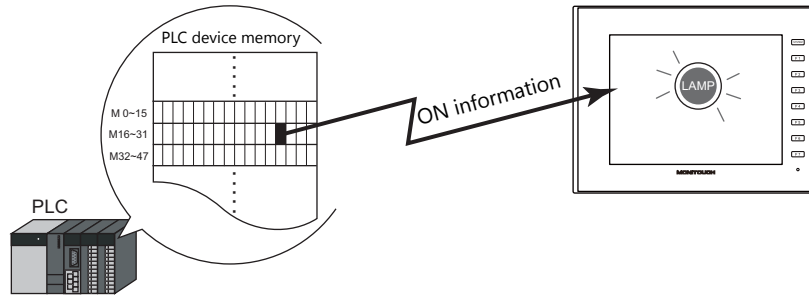

1. Click [Parts] → [Lamp] and place a lamp on the screen.

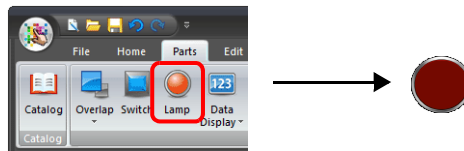

2. Double-click on the lamp to display the settings window.  
Configure the following settings for [Style] and then click [Finish].

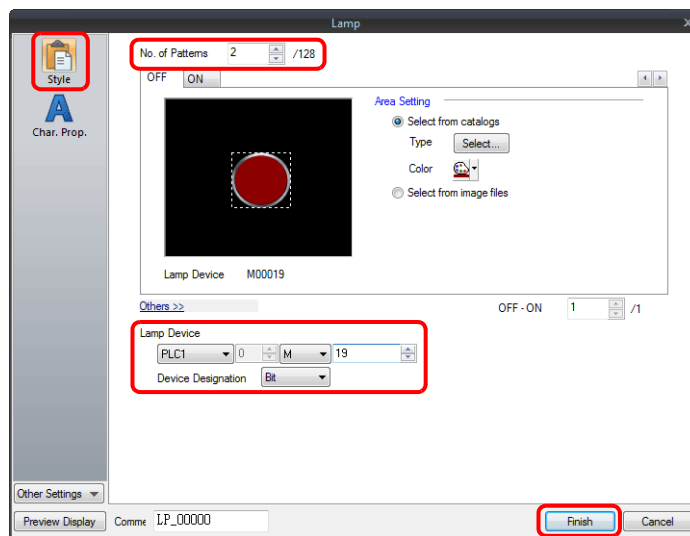

This completes the necessary settings.



## Placing 128 Pattern Lamps

Set a 128 pattern lamp, like the one shown in the figure below.

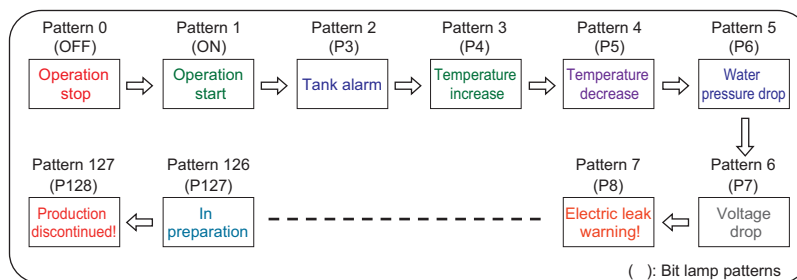

### Setting procedure

- Click [Parts] → [Catalog] to display the catalog window.  
Configure the following settings and drag and drop a lamp onto the screen.

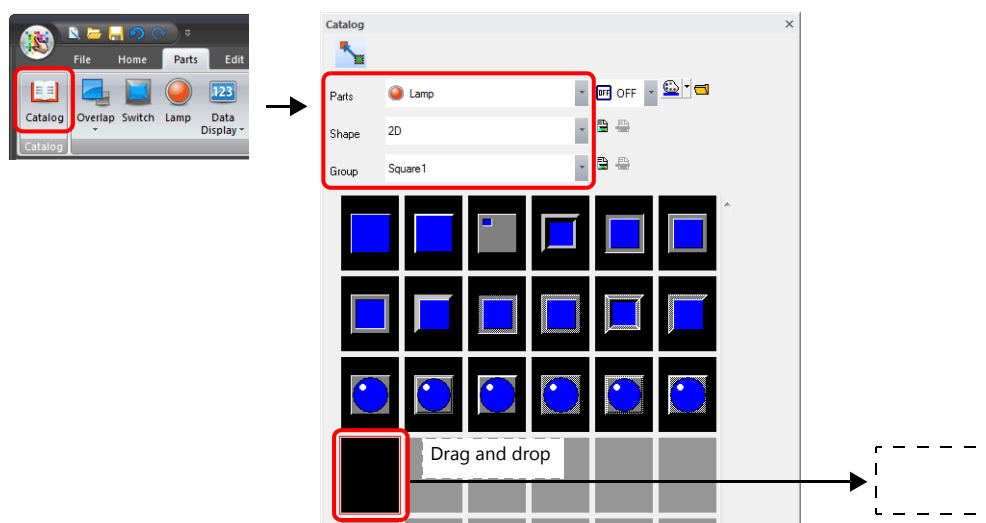

- Double-click on the lamp to display the settings window.  
Configure the [Style] settings as shown below.
  - Bit lamp
    - Lamp device memory: M0  
(Used lamp device memory range: M0 to M126)

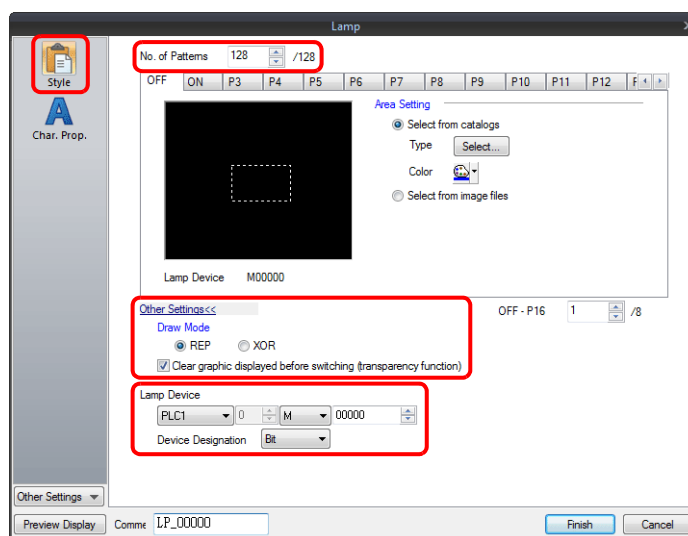

- Word lamp  
Lamp device memory: D100

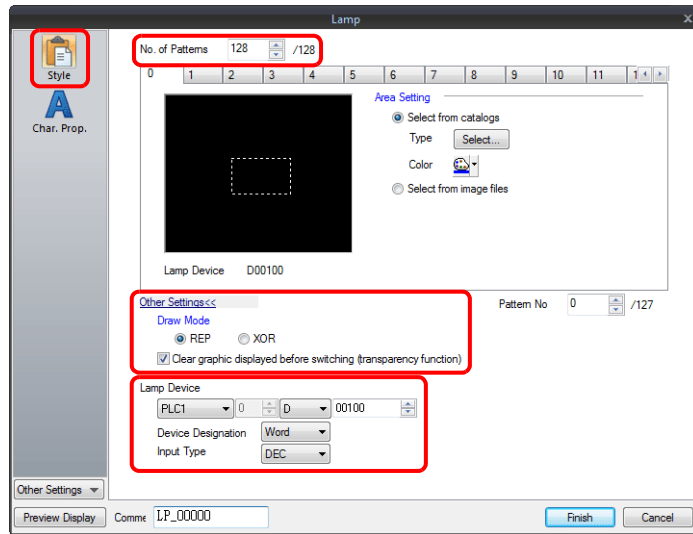

- Configure the [Char. Prop.] settings as shown below.  
Change between the [OFF] to [P128] tab and [0] to [127] tab to register text for each pattern and then click [Finish].
- Bit lamp

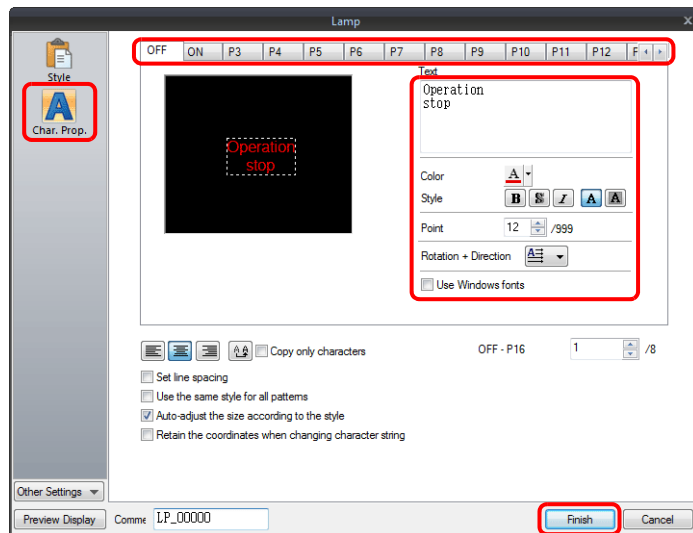

- Word lamp

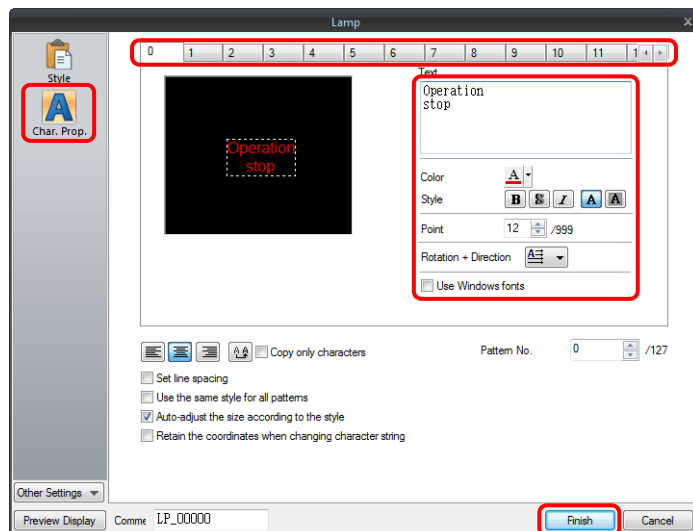

This completes the necessary settings.

## Display example

- Bit lamp

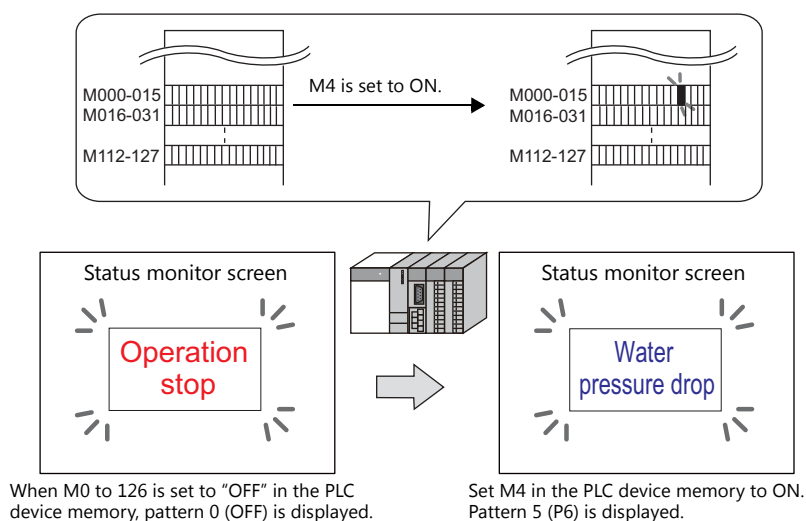

- \* When multiple bits are set to ON, a pattern is displayed according to the most significant bit.

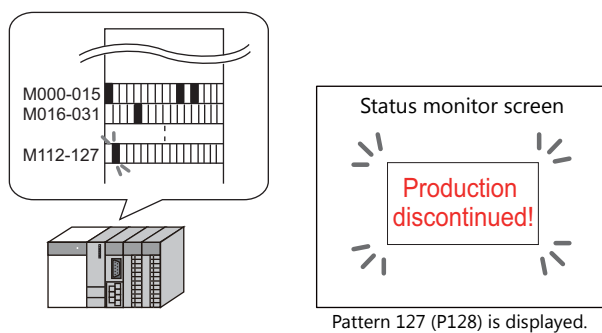

- Word lamp

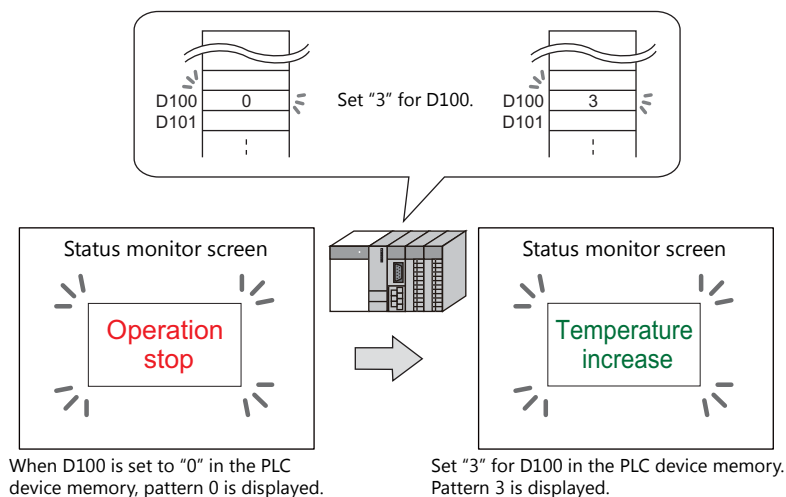

- \* If a value outside the specified range is set for the lamp device memory, the lamp display is not changed.

## Notes

- When placing multiple lamps, set up consecutive addresses for the lamp device memory to ensure high-speed processing.
- When placing multiple lamps that have a different number of screen patterns and the lamp device memory are allocated with consecutive addresses, be careful configuring the settings of the lamp device memory. The required number of bits varies depending on the number of patterns.

## 4.3 Detailed Settings

### Style

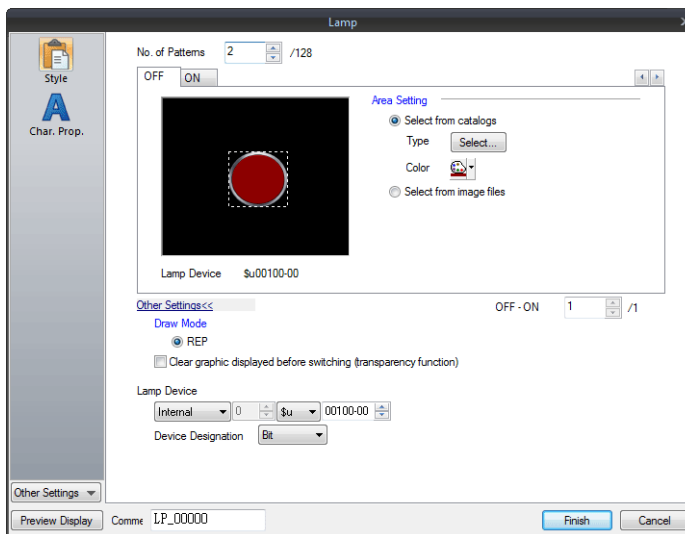

Item		Description
No. of Patterns (2 - 128)		Set the number of patterns that the lamp can display.
Area Setting	Select from catalogs	Select the part design. After selecting the part, select the part color.
	Select from image files	Select a PNG file. The PNG file can be set to all patterns by clicking [Apply to All Patterns].
Frame	Type	Select the frame type of the lamp.
	Color	Select the frame color of the lamp.
Enable flash display function (flashing with OFF pattern)		This item is available when a 3D pattern type <sup>*1</sup> other than an OFF pattern (excluding "Sign" and "3D_128" parts) is selected. Select this checkbox to flash the display between the selected pattern and the OFF pattern.
Other Settings	Draw Mode REP/XOR	REP: Display using the color set in [Area Setting]. XOR: When the lamp device memory is ON, the frame and text are displayed in the color resulting from an XOR operation.  For the difference between REP and XOR, refer to <a href="#">"4.4 Draw Mode" page 4-11.</a>
	Clear graphic displayed before switching (transparency function)	The previous graphic is not retained when the checkbox is selected. For details, refer to <a href="#">"Notes on the transparency function" page 4-7.</a>
Lamp Device	Device Designation	Bit: The lamp display is changed by setting (ON) and resetting (OFF) bits. The required number of bits depends on the number of display patterns. (127 bits maximum) When multiple bits are set (ON), the most significant bit has priority.  Word: The lamp display is changed according to the value specified for the device memory address. The range of setting values varies with the number of patterns. (Range: 0 to 127) If a value outside the specified range is set, the lamp display is not changed.
	Input Type (DEC/BCD)	Specify the input format of the device memory.

\*1 Notes on 3D and 2D pattern types  
Part shapes differ depending on the selection made in the catalog.





- 3D type: Real, Sign, 3D, 3D\_128, HA
- 2D type: 2D

Selection of an image file corresponds to the 3D type.

## Notes on the transparency function

The transparency function is used to create parts that are only displayed when ON or parts only consisting of characters.

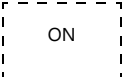
The following shows how parts with transparency placed on the screen are displayed.

	OFF	ON
Part only displayed when ON	Hide 	
Only characters displayed		
Custom parts (Black: transparent color)		

- Clear graphic displayed before switching (transparency function) Unselected  
The previously displayed image remains.

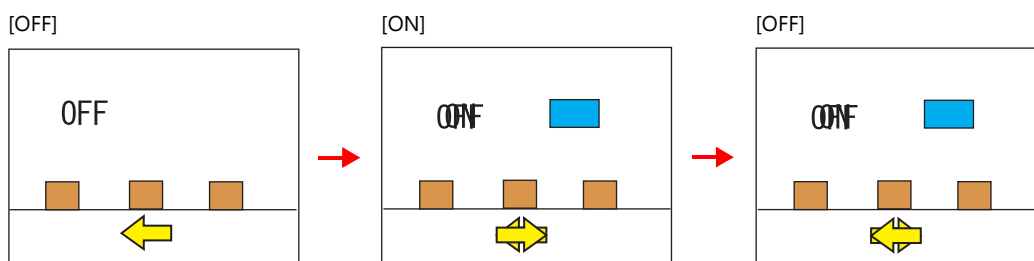

- Clear graphic displayed before switching (transparency function) Selected  
The previously displayed image does not remain. Parts can be displayed even with graphics placed in the background.

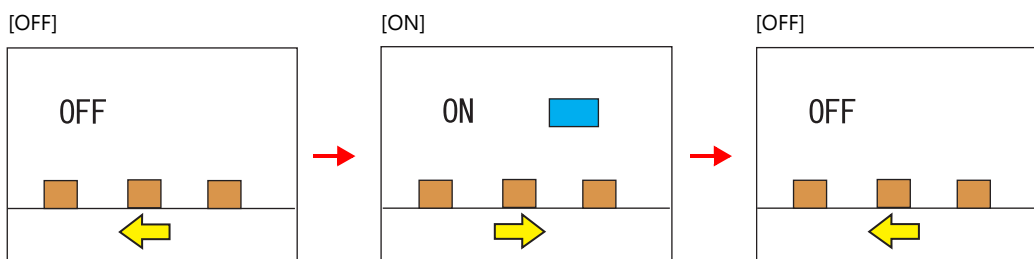

### Notes

- Transparency cannot be set for [Lamp] → [Shape: 2D] → [Group: Square2] parts in the catalog window.

## Char. Prop.

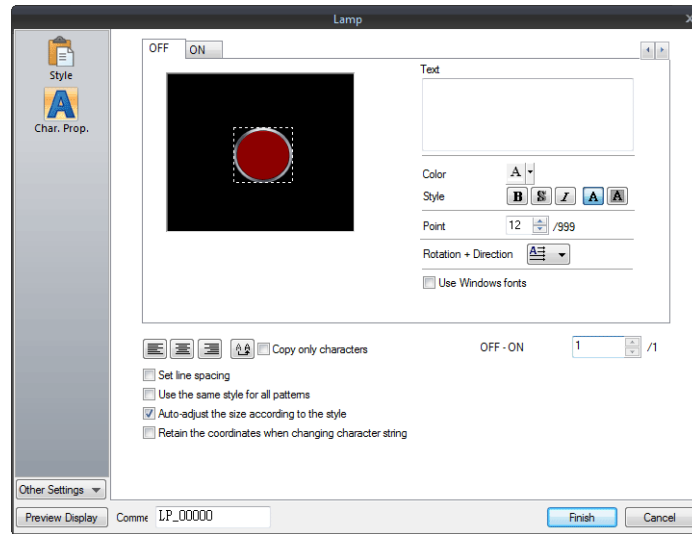

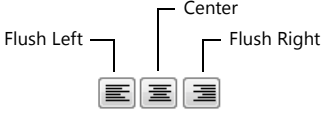
Item	Description
[OFF] [ON] - [P128]	When [Style] → [Other Settings] → [Draw Mode] is [XOR]: Only [OFF] can be selected. Specify the text to be displayed.
Pattern No. (0 - 127)	When [Style] → [Other Settings] → [Draw Mode] is [REP]: Specify the text to be displayed on each pattern.
Text	Enter text to be displayed on the lamp. Up to 4 lines can be registered. Text properties can be set for each line. Text can be justified within the lamp part.
Color (text color, background color)	Set the color for text. The background color can also be set if set as "no transparency" in the following [Style] setting.
Style	Set the text style.
Character Size (1 - 8)	Specify the enlargement factor for text.
Point (6 - 999)	Set the text size.
Rotation + Direction	Set the combination of text rotation and direction. Four combinations are displayed in the drop-down menu.  When selecting an option other than the above, click the icon at the bottom. The window that allows selection from all options is displayed.
Use Windows fonts	Select this checkbox to use a Windows font.
Smooth Font <sup>*1</sup>	Smooth the edges of text. (Only settable for TrueType Windows fonts.)
Alignment	Set the text alignment.  
Text copy Copy only characters	The text and its attributes for the current pattern (OFF, ON, P3) are copied to the other patterns. Select the [Copy only characters] checkbox to copy text and coordinate information to all other patterns. Note that the text properties will not be copied. If the destination for copy has no text, text properties will also be copied.
Set line spacing	Set the pitch between lines.
Use the same style for all patterns	Select this checkbox to configure the same settings as the opened pattern attributes with respect to all lamp patterns (for each respective line if multiple lines are included).
Auto-adjust the size according to the style	Select this checkbox to automatically adjust the lamp size to the entered text.
Retain the coordinates when changing character string	Newly registered text is placed by centering. When any registered text is changed while this checkbox is selected, the coordinates remain the same. When a line is added to the existing text while this checkbox is selected, the added line is aligned with the upper line.
4-Line Display	Select this checkbox to divide the text entry area into four lines. This allows different properties to be specified for each line when using Windows fonts.

\*1 Cannot be set to transparent.

## Function

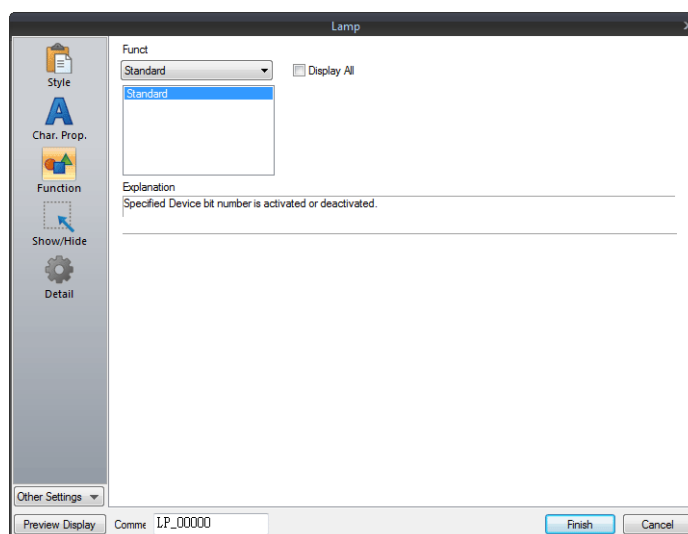

Item	Description
Function	Set the type of operation to be performed by the lamp.
Standard	Use as a standalone part without any dependencies on other parts.
Display All	Select this checkbox to display all of the available lamp functions. *1

\*1 The following function is added when the [Display All] checkbox is selected.

Name	Description	Linked Part	Refer to
Standard	Mode	Alarm Message mode	<a href="#">page 8-1</a> <a href="#">page 12-1</a>

## Show/Hide

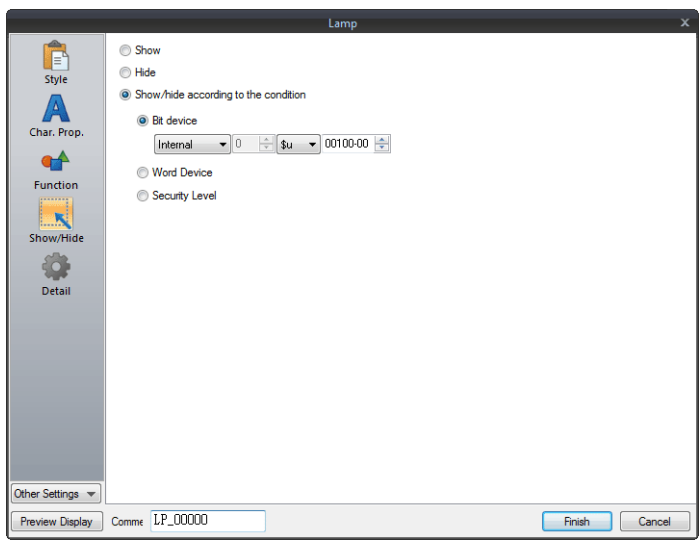

Item		Description
Show		Display the numerical data display on the screen.
Hide		Do not display the numerical data display on the screen.
Show/Hide according to the condition	Bit device	Display the switch if the device memory bit is ON and hide the switch if the device memory bit is OFF.
	Word Device	Show the switch if the condition is satisfied and hide the switch if the condition is not satisfied.
		Constant Display Type
	Condition expression	Set a comparison sign, value, and device memory address as the conditions for comparison.
Security Level		This setting is available when using the security function. The "show/Hide" attribute can be controlled according to the user's login level. For details, refer to "5 Security" in the V9 Series Reference Manual 2.

## Detail

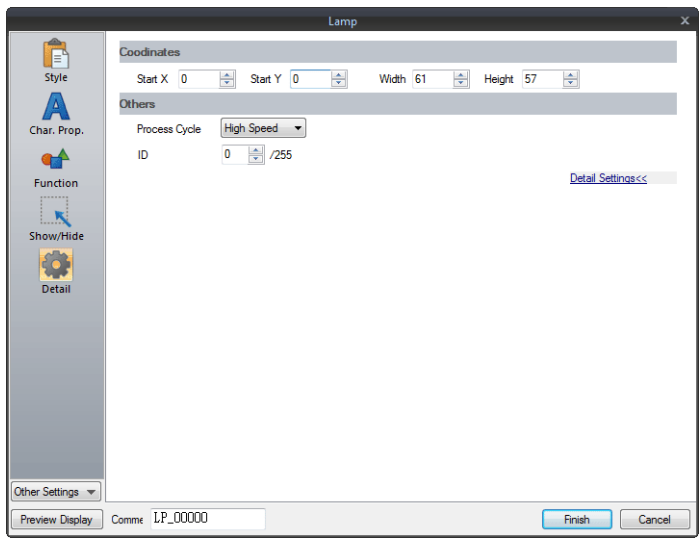

Item		Description
Coordinates	Start X/Start Y	Set the display position of the lamp using X and Y coordinates.
	Width/Height	Set the size of the lamp by specifying width and height.
Others	Process Cycle	Set a cycle for the V9 series to read PLC data while the V9 series is communicating with the PLC. For details, refer to "1.2 Process Cycle".
	ID (0 - 255)	Set the ID. For details on IDs, refer to the V9 Series Operation Manual.



## 4.4 Draw Mode

### XOR

#### Shape: 2D, group: square2

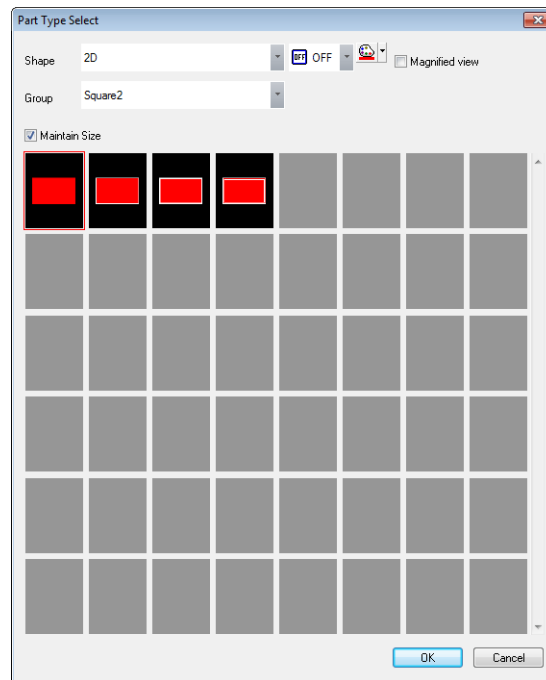

#### Text

When setting text on a lamp, the same text is displayed for both OFF and ON statuses.

Set text on the [OFF] tab of [Char. Prop.].

#### Color

- OFF frame color/ON color/OFF color  
Set the lamp color via [Style] in the lamp settings window.
- OFF text color  
Set the text color via [Char. Prop.] in the lamp settings window.
- ON frame color  
The frame color to use when the lamp is ON cannot be set. It is automatically determined by an XOR operation as shown below.

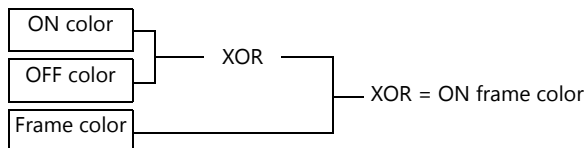

- ON text color  
The text color to use when the lamp is ON cannot be set. It is automatically determined by an XOR operation as shown below.

The text displayed when the lamp is ON is the same as that displayed when the lamp is OFF.

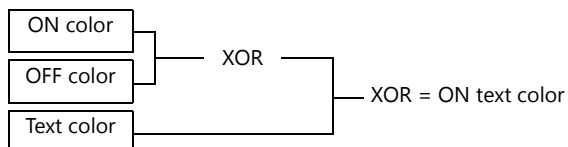

Display example

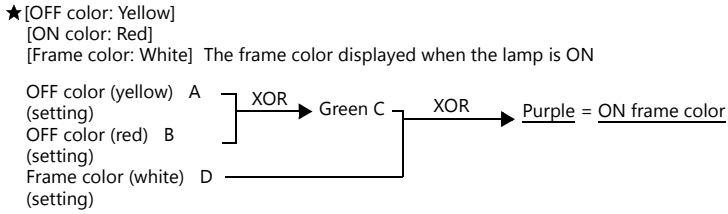

			B						D
	Bla	Blu	(R)	Mag	Gre	C	Y	(W)	
	Bla	Blu	R	Mag	Gre	C	Y	W	
	Blu	Blu	Bla	Mag	R	C	Gre	W	Y
	R	R	Mag	Bla	Blu	Y	W	Gre	C
	Mag	Mag	R	Blu	Bla	W	Y	C	Gre
C	(Gre)	Gre	C	Y	W	Bla	Blu	R	(Mag)
	C	C	Gre	W	Y	Blu	Bla	Mag	R
A	(Y)	Y	W	(Gre)	C	R	Mag	Bla	Blu
	W	W	Y	C	Gre	Mag	R	Blu	Bla
			C						

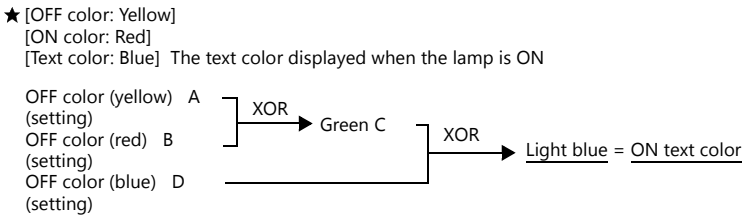

			D	B					
	Bla	(Blu)	(R)	Mag	Gre	C	Y	W	
	Bla	Blu	R	Mag	Gre	C	Y	W	
	Blu	Blu	Bla	Mag	R	C	Gre	W	Y
	R	R	Mag	Bla	Blu	Y	W	Gre	C
	Mag	Mag	R	Blu	Bla	W	Y	C	Gre
C	(Gre)	Gre	(C)	Y	W	Bla	Blu	R	Mag
	C	C	Gre	W	Y	Blu	Bla	Mag	R
A	(Y)	Y	W	(Gre)	C	R	Mag	Bla	Blu
	W	W	Y	C	Gre	Mag	R	Blu	Bla
			C						

**For parts other than [Shape: 2D], [Group: Square2]**

**Text**

When setting text on a lamp, the same text is displayed for both OFF and ON statuses.  
 Set text on the [OFF] tab of [Char. Prop].

**Color**

- OFF color  
 Set the lamp color via [Style] in the lamp settings window.
- ON color  
 The color resulting from an XOR operation on the color specified for [Style] and the OFF color (explained above) is displayed.
- P3 to P128 color  
 As with the ON color, the color resulting from an XOR operation on the color specified in the settings window and the OFF color is displayed.

**Notes**

Draw mode: When an XOR operation is performed, the colors that can be used are the 16 colors displayed on [Custom Color] → [Palette 1].  
 If a color other than the following 16 colors is selected, the XOR color may not be displayed correctly.

[Palette 1]

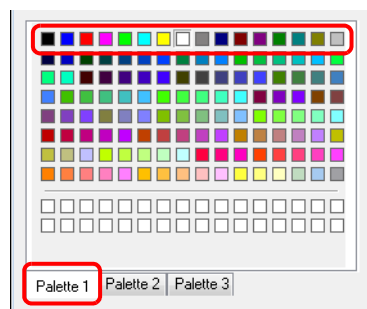

## REP

### Shape: 2D, group: square2

#### Text

When placing text on a lamp part in "REP" draw mode, the following two modes are available.

- When displaying different text when the lamp is ON and OFF:

OFF text

Set text on the [OFF] tab of [Char. Prop.].

ON text

Set text on the [ON] tab of [Char. Prop.].

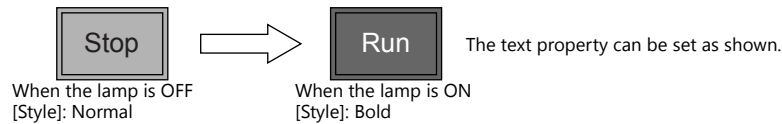

- When displaying the same text when the lamp is ON and OFF:

OFF text

Set text on the [OFF] tab of [Char. Prop.].

ON text

Nothing is set for the text on the [OFF] tab of [Char. Prop.].

The text set in the character input box [OFF] is displayed when the lamp is ON.

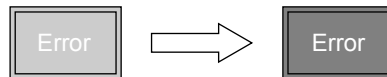

#### Color

- ON frame color, OFF frame color, ON color, OFF color  
Set the lamp color via [Style] in the lamp settings window.  
The same frame color is used when the lamp is ON and OFF.
- OFF text color  
Set color on the [OFF] tab of [Char. Prop.].
- ON text color  
Set color on the [ON] tab of [Char. Prop.].  
The part is displayed in the selected colors.

### For parts other than [Shape: 2D], [Group: Square2]

This case is mostly the same as when [Group] is set to "Square2". (Refer to [page 4-13](#).)

#### Differences

- ON frame color, ON color  
Set the lamp color via [Style] in the lamp settings window.  
A color different from the OFF frame color can be set.
- For P3 to P128, the selected colors are shown.

#### Notes

- When the OFF text color and the ON color are the same, the text cannot be shown when the lamp is turned ON.

## Other Notes

### Number of lamps

A maximum of 4096 lamp parts can be created on a single screen.  
For details, refer to the V9 Series Operation Manual.

### Placing multiple lamp parts

When placing lamps overlaid, they are displayed as shown in the editor.  
Take the following operations into consideration when creating screens.

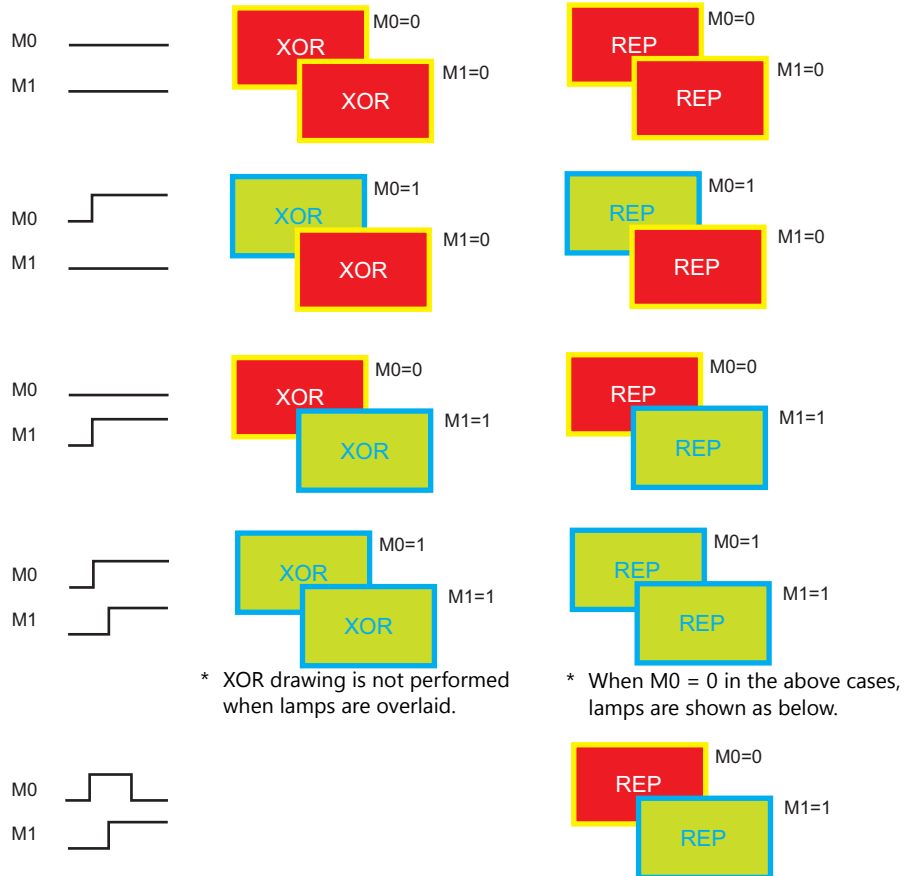

## **5 Data Display**

---

5.1 Numerical Display

5.2 Character Display

5.3 Message Display

5.4 Table Data Display

5.5 Notes

## 5.1 Numerical Display

### 5.1.1 Overview

- Numerical data read from the PLC is displayed in real time on the screen in any of the following formats: DEC (w/o sign), DEC (with sign -), DEC (with sign +-), HEX (hexadecimal), OCT (octal), BIN (binary) and Real Number Type (decimal floating-point).

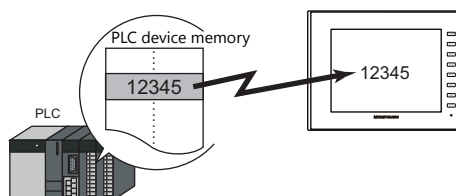

- Data read from the PLC can be shown on a 7 segment display.

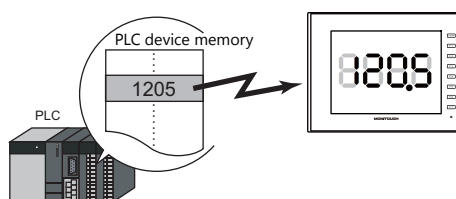

- It is possible to show data in a different color when it exceeds or falls short of a specific range. This setting can easily attract the operator's attention to the situation.

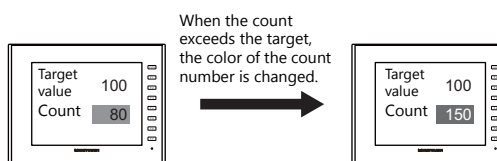

For example settings, refer to ["Monitoring PLC Device Memory" page 5-4](#).

- MONITOUCH can read data from the PLC, perform calculations, and display the result on the MONITOUCH screen.

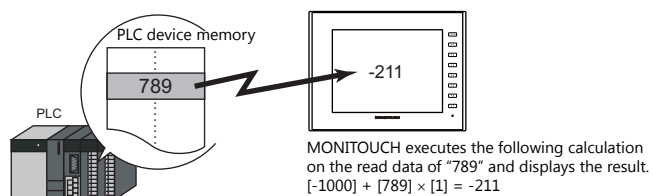

- In addition to using numerical data displays ([Num. Display]) independently, they can also be linked to other parts. For example, in order to indicate data as a percentage in the statistic graph as shown below, it is necessary to link [Num. Display] with [Statistic Graph].

This allows the percentage value to automatically reflect changes in the data of the statistic graph.

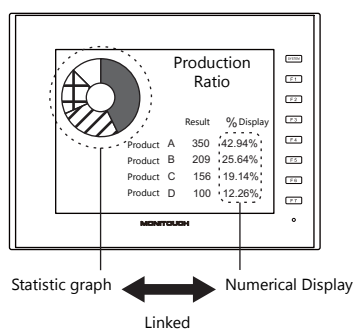

For details, refer to ["9.5 Statistic Bar Graph"](#) ["9.6 Statistic Pie Graph"](#).

- Device memory for offset value designation

A single numerical display part can be used to show different data by switching the device memory address assigned to the part. This can help to reduce the number of screens or parts used and facilitate screen maintenance.

Example: Displaying scheduled production volume, non-defective count, and defective count for a machine selected from No. 1 to 3

Numerical Display

- Machine number : D100 (device memory)
- Scheduled production volume : D100 (base), D100 (offset value designation)
- Non-defective count : D110 (base), D100 (offset value designation)
- Defective count : D120 (base), D100 (offset value designation)

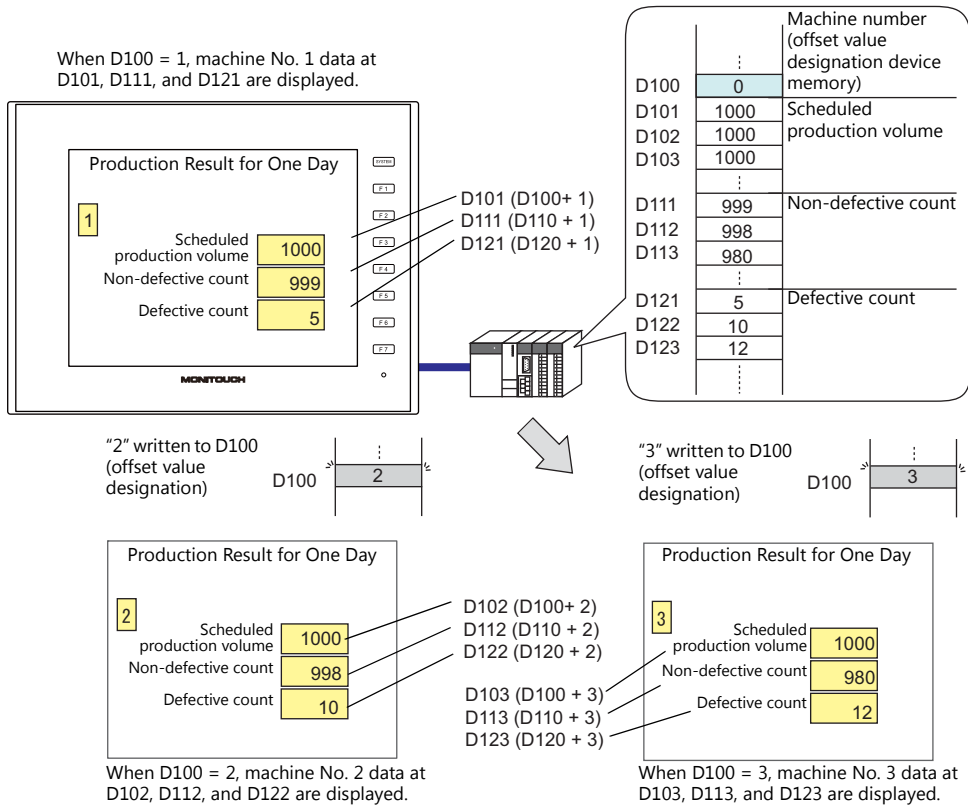

- Specifying attributes using device memory

The attributes (number of digits, decimal point, display type, or text color) of numerical display parts are easily changeable while MONITOUCH is in RUN mode.

Example: Numerical data display D100 (no transparency)  
Change the decimal place from 0 to 1, text color from black to red, and background color from white to yellow.

Device memory addresses for changing attributes

Decimal Point : D200

Text color : D201

Back Color : D202

Display Type : D203

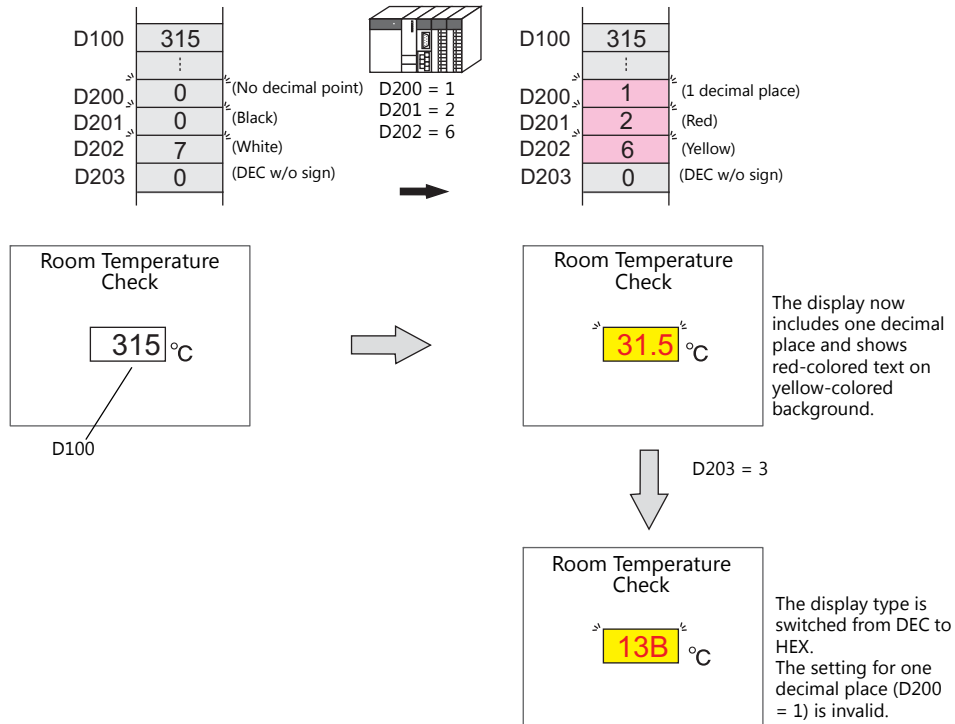



## 5.1.2 Setting Examples

### Monitoring PLC Device Memory

This example explains monitoring of a PLC device memory D100.

The numerical data display is shown in red when the value is less than "100" and yellow when the value exceeds "1000".

1. Click [Parts] → [Data Display] → [Num. Display] and place a numerical data display on the screen.

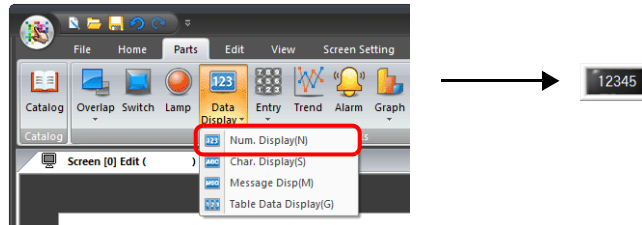

2. Double-click on the switch to display the settings window. Configure the [Contents] settings as shown below.

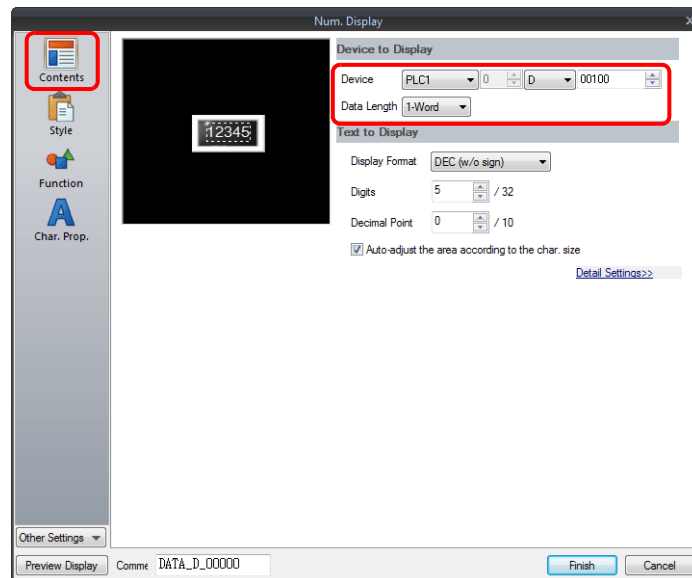

3. Click [Other Settings] → [Operation/Alarm]. Configure the following settings for [Operation/Alarm] and then click [Finish].

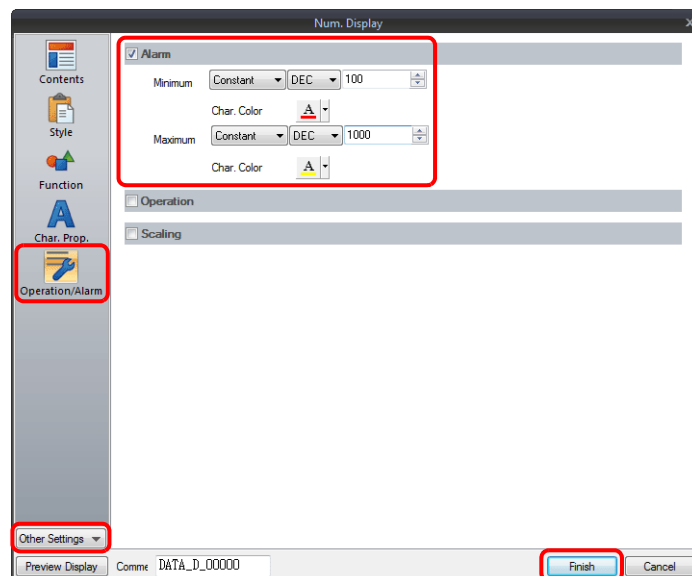

This completes the necessary settings.

## 5.1.3 Detailed Settings

### Contents

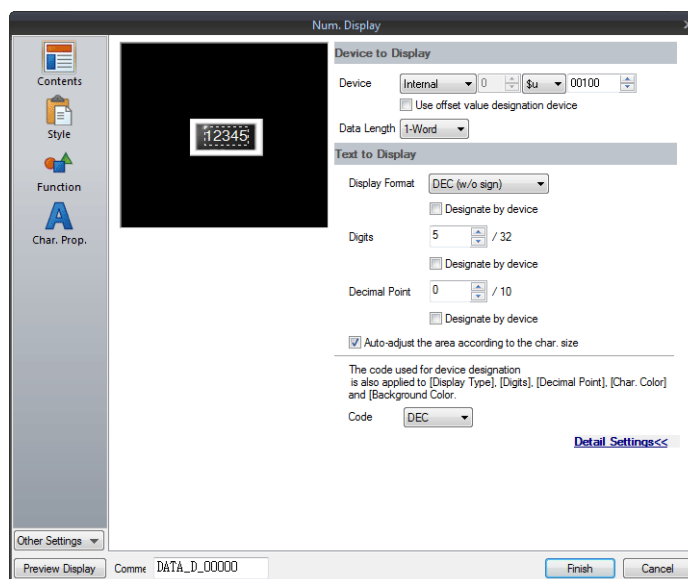

Item	Description								
Device to Display	Device (base device memory)	Specify the device memory address to use for numerical data display.							
	Use offset value designation device <sup>*1 *2</sup>	Set the device memory address and the code used for storing an offset value with respect to the value in the base device memory. <table border="1" data-bbox="678 1086 1129 1220"> <thead> <tr> <th>Code</th> <th>Setting Range</th> </tr> </thead> <tbody> <tr> <td>DEC</td> <td>0 - 65535</td> </tr> <tr> <td>BCD</td> <td>0 - 9999</td> </tr> <tr> <td>Real Number Type (DEC)</td> <td>0 - 65535</td> </tr> </tbody> </table>	Code	Setting Range	DEC	0 - 65535	BCD	0 - 9999	Real Number Type (DEC)
Code	Setting Range								
DEC	0 - 65535								
BCD	0 - 9999								
Real Number Type (DEC)	0 - 65535								
	Data Length <sup>*3</sup> 1-Word/2-Word	Select the data length used for this part.							
Text to Display	Display Format	Select the format of numbers to be displayed on the screen.							
	Designate by device <sup>*4</sup>	Select this checkbox to change the display format according to the value specified for the device memory address. * This item cannot be used when "Real Number Type" is specified above for [Display Format].							
	Digits <sup>*5</sup>	Specify the number of digits for the numerical data display.							
	Designate by device <sup>*4</sup>	Select this checkbox to change the number of digits according to the value specified for the device memory address.							
	Decimal Point	Specify the decimal place. The number of decimal places must be smaller than the number of digits. When no decimal point is required, set "0".							
	Designate by device <sup>*4</sup>	Select this checkbox to change the decimal point according to the value specified for the device memory address.							
	Auto-adjust the area according to the char. size	Select this checkbox to automatically adjust the item size based on the [Digits] and [Decimal Point] settings.							
Code	When a [Designate by device] checkbox is selected, set the code used when reading values from the device memory address. This setting applies to [Display Format], [Digits], [Decimal Point], [Char. Color], and [Background].								

- \*1 The device memory for offset value designation is read every cycle, regardless of the item processing cycle. Screen updates depend on the setting of the [Redraw the screen] checkbox in [Screen Setting] → [Screen Setting] → [Unhide] → [Unhide Items].
  - Selected:
    - Update the screen when the value in the device memory for offset value designation changes.
    - Only update the items on the screen whose value changed in the device memory for offset value designation (the screen is not redrawn).
  - Unselected:
    - The screen is updated at the following times.
    - Screen change/screen redraw/multi-overlap change (when there are parts placed on multi-overlap)

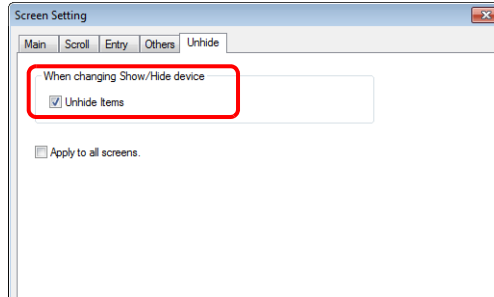

- \*2 Notes on using the device memory for offset value designation
  - When the screen is updated, the device memory for offset value designation is read for the items placed on the screen. This means that for a screen that includes multiple addresses of the device memory for offset value designation, the updated screen is displayed upon completion of reading all of these device memory addresses. If screen updates are taking too long, use of the internal device memory is recommended.
  - When setting offset values on a screen, the setting needs to be completed before the screen is changed to another screen. In a case where an offset value is designated in an OPEN macro, the offset value is not valid when the screen is open, but becomes valid when the screen is updated.
  - An error occurs if a value set to the device memory for offset value designation is outside the permissible range. Observe the specified range for setting.
- \*3 Relationship between data length and display format

Code Format	1-word Display Range	2-word Display Range
DEC (w/o sign)	0 - 65535	0 - 4294967295
DEC (with sign -)	-32768 - 32767	-2147483648 - 2147483647
DEC (with sign +-)	-32768 - +32767	-2147483648 - +2147483647
HEX	0 - FFFF	0 - FFFFFFFF
OCT	0 - 177777	0 - 3777777777
BIN (Binary)	0 - 1111111111111111	0 - 11111111111111111111111111111111



- \*4 For details on the method for specifying attributes using device memory, refer to ["Specifying attributes using device memory"](#) page 5-7.
- \*5 When a value exceeding the set number of digits is entered:

Code Format	DEC	HEX/OCT/BIN
Display	Overflow display	Numbers from the right
E.g.: Data length: 1 word Digits: 3 Entered value: 1010	---	010

## Specifying attributes using device memory

When a [Designate by device] checkbox in [Contents] → [Detail Settings] or a [Designate by device] checkbox in [Char. Prop.] → [Detail Settings] is selected, the corresponding attribute can be changed by specifying a value using a device memory address.

Item	Description														
Contents	<p>Specify the display format for the numerical data display. Set a value according to the following.</p> <p>1: DEC (w/ -sign) 2: DEC (w/ +-sign) 3: HEX 4: OCT 5: BIN 6: FLOAT* 7: BCD (w/o sign) 8: BCD (w/ -sign) 9: BCD (w/ +-sign)</p> <p><b>* This setting is enabled when "2-Word" is set for [Contents] → [Data Length].</b></p>														
	<p>When the numerical data display includes decimal places, specify the total number of digits including the number of decimal places.</p> <table border="1" data-bbox="639 719 1098 954"> <thead> <tr> <th>Display Type</th> <th>Digits</th> </tr> </thead> <tbody> <tr> <td>DEC</td> <td>1 - 10</td> </tr> <tr> <td>HEX</td> <td>1 - 8</td> </tr> <tr> <td>OCT</td> <td>1 - 11</td> </tr> <tr> <td>BCD</td> <td>1 - 8</td> </tr> <tr> <td>BIN</td> <td>1 - 32</td> </tr> <tr> <td>FLOAT</td> <td>1 - 32</td> </tr> </tbody> </table> <p><b>* If a read value exceeds the limit specified for the number of digits, hyphens are displayed to indicate that an overflow occurred.</b></p>	Display Type	Digits	DEC	1 - 10	HEX	1 - 8	OCT	1 - 11	BCD	1 - 8	BIN	1 - 32	FLOAT	1 - 32
Display Type	Digits														
DEC	1 - 10														
HEX	1 - 8														
OCT	1 - 11														
BCD	1 - 8														
BIN	1 - 32														
FLOAT	1 - 32														
	<p>Specify the number of decimal places for the numerical data display.</p> <table border="1" data-bbox="639 1077 1098 1240"> <thead> <tr> <th>Display Type</th> <th>Digits</th> </tr> </thead> <tbody> <tr> <td>DEC</td> <td>0 - 9</td> </tr> <tr> <td>BCD</td> <td>0 - 7</td> </tr> <tr> <td>FLOAT</td> <td>0 - 31</td> </tr> <tr> <td>HEX/OCT/BIN*</td> <td>-</td> </tr> </tbody> </table> <p><b>* The number of decimal places must be smaller than the total number of digits. An overflow will occur if the number of decimal places is the same or more than the total number of digits.</b> <b>When [Display Format] is set to "HEX", "OCT", or "BIN (Binary)", the decimal point setting does not take effect.</b> <b>Even if a value is set for [Decimal Point] in such a case, it is assumed to be zero.</b></p>	Display Type	Digits	DEC	0 - 9	BCD	0 - 7	FLOAT	0 - 31	HEX/OCT/BIN*	-				
Display Type	Digits														
DEC	0 - 9														
BCD	0 - 7														
FLOAT	0 - 31														
HEX/OCT/BIN*	-														

Item	Description
<p>Char. Prop.</p> <p>Char. Color</p>	<p>Set the color for text.</p> <p> — Text color</p> <p>Bits 0 to 6: Color Bit 7 : Blinking (0: No, 1: Yes)</p> <div data-bbox="710 369 1220 548"> </div> <p>A color can be selected from the 128 colors (and blinking) on [Palette 1] in the [Custom Color] window. Colors correspond to the following color codes.</p> <div data-bbox="614 660 1236 1120"> </div>
<p>Background</p>	<p>Specify the background color of text.</p> <p> — Background color</p> <p>Bits 0 to 6: Color Bit 7: Blinking (0: No, 1: Yes)</p> <div data-bbox="710 1310 1220 1489"> </div> <p>A color can be selected from the 128 colors (and blinking) on [Palette 1] in the [Custom Color] window. For details on color codes, refer to the "Char. Color" section. * <b>However, note that the background color setting does not take effect when [Char. Prop.] → [Style] is set to "transparent".</b></p>

**Notes on changing attributes using device memory**

- The update timing depends on the setting of [Detail] → [Process Cycle] of each part.
- For parts with a frame, the frame size does not change according to the setting of [Digits], [Decimal Point], or [Display Format].  
For this reason, the maximum number of digits in the screen program must be set in advance.
- When [Char. Prop.] → [Style] is set to "not transparent", the drawing range of the background drawing area will be affected by changes to the settings of [Digits], [Decimal Point], and [Display Format]. This means that if the set number of digits decreases, the background color will remain on the screen.  
For this reason, the maximum number of digits in the screen program must be set in advance. Alternatively, update the display by executing the "SYS (RESET\_SCRN)" macro command or by changing the screen.
- If a displayed value has become higher than the maximum or lower than the minimum specified for alarm, the value is shown in the color specified for the alarm.
- The "CHG\_DATA" macro command cannot be used with numerical data displays for which a [Designate by device] checkbox is selected.
- When "Entry Target" is set for [Function], the display is switched when the cursor is moved from the display field.

## Style

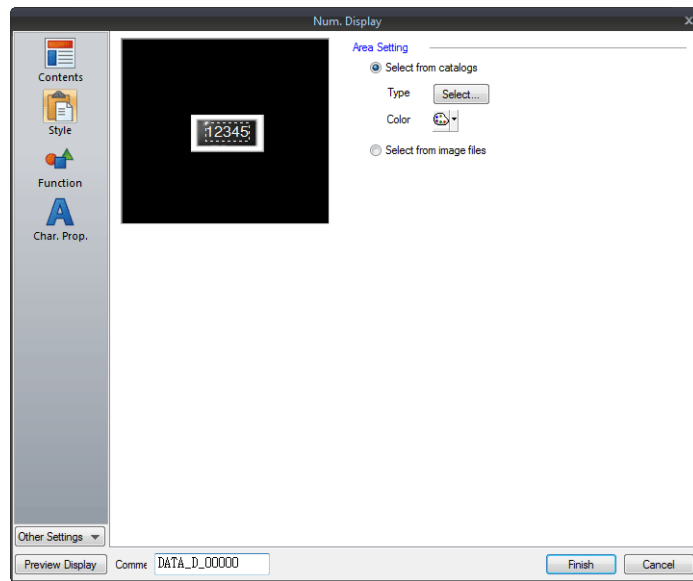

Item		Description
Area Setting	Select from catalogs	Select the part design. After selecting the part, select the part color.
	Select from image files	Select a PNG file.

## Function

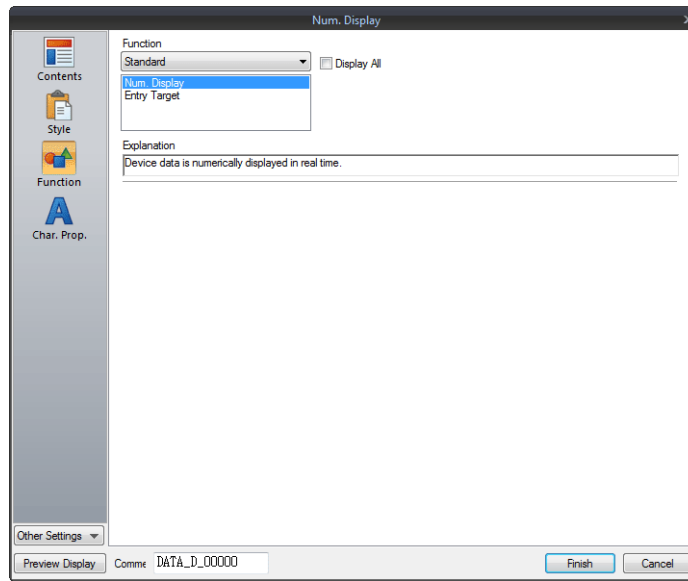

Item	Description
Function	Set the type of operation performed by the numerical data display.
Standard	Num. Display Display device memory values on the numerical data display in real time.
Entry Target	Used in conjunction with the entry function. For details, refer to "6.1 Numerical Data Entry".
Display All	Select this checkbox to display all of the available numerical data display functions. *1

\*1 The following function is added when the [Display All] checkbox is selected.

Name	Description	Linked Part	Refer to
Standard	Entry Display Part	Entry	<a href="#">page 6-1</a>
	Max. Value Display Part		
	Min. Value Display Part		
	Statistic Graph % Display	Statistic graph Statistic pie graph	<a href="#">page 9-47</a> <a href="#">page 9-53</a>
	Digital Switch	Switch	<a href="#">page 3-23</a>
Logging	Logging Count Display	Trend	<a href="#">page 7-1</a>
	Logging Time Display		
	Mean Value Display		
	Max. Display		
	Min. Display		
	Total Display		
	Display start time		
	Display end time		
Alarm	Count Display	Alarm	<a href="#">page 8-1</a>
	Time Display		

## Char. Prop.

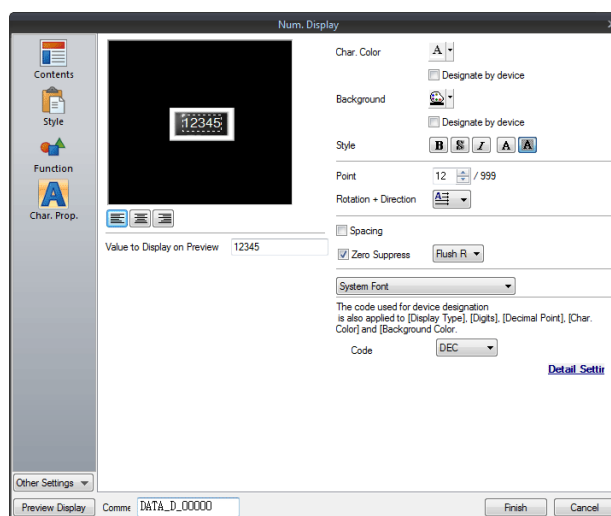

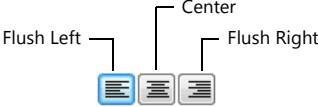
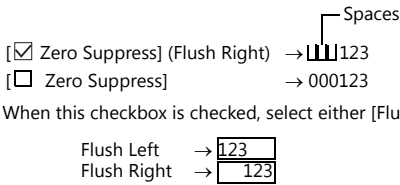
Item	Description
Alignment	Set the text alignment. 
Value to Display on Preview	This item is available when the [Display for the editor] checkbox is selected on the [View] → [Display Environment] → [Display] tab. Set the value to display using the editor.
Char. Color	Set the color for text.
Designate by device <sup>*1</sup>	Select this checkbox to change the text color according to the value specified for the device memory address.
Background	Set the background color of text.
Designate by device <sup>*1</sup>	Select this checkbox to change the background color according to the value specified for the device memory address.
Style	Set the text style.
Character Size (1 - 8)	Specify the enlargement factor for text.
Point (6 - 999)	Set the text size.
Rotation + Direction	Set the combination of text rotation and direction. Four combinations are displayed in the drop-down menu.  When selecting an option other than the above, click the icon at the bottom. The window that allows selection from all options is displayed.
Spacing	Select this checkbox to specify the spacing between characters.
Zero Suppress	Select this checkbox to use zero suppression.  When this checkbox is checked, select either [Flush Left] or [Flush right].
System Font	Select the font to use for the numerical data display. When "7-segment Font" is selected, select the [Display light-out segments] checkbox to display unlit segments.
Windows Font	
7-segment Font	
Smooth Font <sup>*2</sup>	When "Windows Font" is selected, select this checkbox to smooth the edges of text. (Only settable for TrueType Windows fonts.)
Display light-out segments <sup>*3</sup>	When "7-segment Font" is selected, select this checkbox to display unlit segments.
Code	When a [Designate by device] checkbox is selected, set the code used when reading values from the device memory. This setting applies to [Display Format], [Digits], [Decimal Point], [Char. Color], and [Background].

<sup>\*1</sup> For details on the method for specifying attributes using device memory, refer to "Specifying attributes using device memory" page 5-7.

<sup>\*2</sup> Cannot be set to transparent.

<sup>\*3</sup> Featuring digital display fonts by Yourname, Inc.



## Operation/Alarm

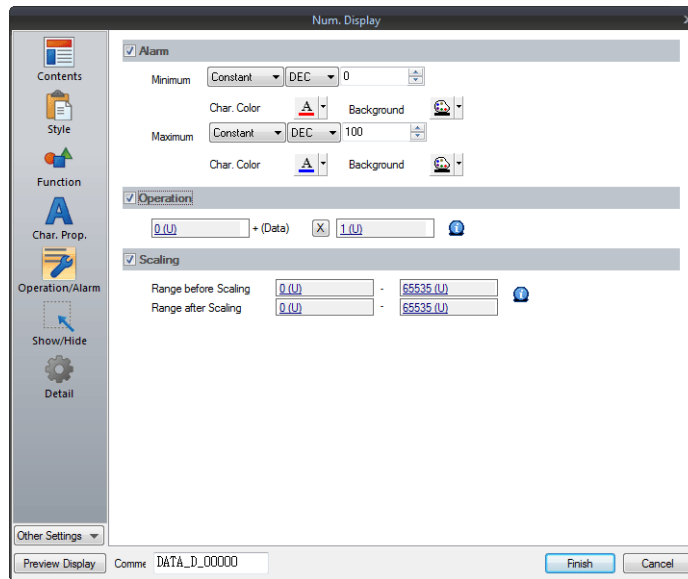

Item	Description																
Alarm	Select this checkbox to display data in a different color when it exceeds or falls short of a specific range. When "Entry Target" is selected for [Function], the range of values that can be entered using a keypad can be set. For details on numerical value entry, refer to "6.1 Numerical Data Entry".																
<table border="1"> <tr> <td rowspan="4">Minimum</td> <td>Use offset value designation device</td> <td>Set the device memory and code used for storing an offset value for the minimum value.</td> </tr> <tr> <td>Char. Color</td> <td>Set the color for text.</td> </tr> <tr> <td>Background</td> <td>Set the background color of text.</td> </tr> <tr> <td>Maximum</td> <td>Set the maximum value used to trigger an alarm.</td> </tr> <tr> <td rowspan="3">Maximum</td> <td>Use offset value designation device</td> <td>Set the device memory and code used for storing an offset value for the maximum value.</td> </tr> <tr> <td>Char. Color</td> <td>Set the color for text.</td> </tr> <tr> <td>Background</td> <td>Set the background color of text.</td> </tr> </table>	Minimum	Use offset value designation device	Set the device memory and code used for storing an offset value for the minimum value.	Char. Color	Set the color for text.	Background	Set the background color of text.	Maximum	Set the maximum value used to trigger an alarm.	Maximum	Use offset value designation device	Set the device memory and code used for storing an offset value for the maximum value.	Char. Color	Set the color for text.	Background	Set the background color of text.	
Minimum		Use offset value designation device	Set the device memory and code used for storing an offset value for the minimum value.														
		Char. Color	Set the color for text.														
		Background	Set the background color of text.														
	Maximum	Set the maximum value used to trigger an alarm.															
Maximum	Use offset value designation device	Set the device memory and code used for storing an offset value for the maximum value.															
	Char. Color	Set the color for text.															
	Background	Set the background color of text.															
Operation <sup>*1</sup>	Select this checkbox to perform an operation on the value of the device memory specified in [Contents].  <div style="text-align: center;"> </div>																
Scaling <sup>*2</sup>	Select this checkbox to display data after automatically converting the data read from the PLC ([Range before Scaling]) to the specified range ([Range after Scaling]). This eliminates the need for correction programs for data read from the PLC when displaying information such as temperature, rotation speed, etc.  <div style="text-align: center;"> </div>																
<table border="1"> <tr> <td>Range before Scaling</td> <td>Specify the data to be read from the PLC.</td> </tr> <tr> <td>Range after Scaling</td> <td>Specify the range of data to be shown on MONITOUCH.</td> </tr> </table>	Range before Scaling	Specify the data to be read from the PLC.	Range after Scaling	Specify the range of data to be shown on MONITOUCH.													
Range before Scaling	Specify the data to be read from the PLC.																
Range after Scaling	Specify the range of data to be shown on MONITOUCH.																

## \*1 Operations

Example: Data read from PLC is "789".

- When "BCD" is selected for [Input Type] and negative numbers are displayed (Negative numbers do not exist in the BCD format.)  
Select either [DEC (with sign -)] or [DEC (with sign +-)] for [Contents] → [Display Type].

[offset value]	+	(data)	[×]	[multiplier]	=	display data		
[0]	+	(789)	[×]	[-1]	=	-789		
Or		[-1000]	+	(789)	[×]	[1]	=	-211

- Example of multiplication

[offset value]	+	(data)	[×]	[multiplier]	=	display data
[1000]	+	(789)	[×]	[1]	=	1789
[0]	+	(789)	[×]	[100]	=	78900

- Example of division with a decimal point  
When "2" is entered for [Decimal Point] in [Contents], "7.89" is read into MONITOUCH.

[offset value]	+	(data)	[÷]	[divisor]	=	display data
[0]	+	(7.89)	[÷]	[100]	=	0.0789

Data is rounded down to two decimal places to display "0.07".

- Example of division without a decimal point

[offset value]	+	(data)	[÷]	[divisor]	=	display data
[0]	+	(789)	[÷]	[-100]	=	-7.89

Data is rounded to a whole number to display "-7".

[offset value]	+	(data)	[÷]	[divisor]	=	display data
[200]	+	(789)	[÷]	[100]	=	207.89

Data is rounded to a whole number to display "207".

Example: When an operation is set for "Entry Target" (entry mode)

- The value entered using a keypad is displayed (= result of operation).  
The value (i.e. data) stored in the device memory is the source value used in the operation.

[offset value]	+	(data)	[×]	[multiplier]
[0]	+	(A)	[×]	[100]

Input of "100"	→	100 = (A) × 100	→ (A) = 1
Input of "550"	→	550 = (A) × 100	→ (A) = 5 (remainder of 50 is ignored, "500" is displayed)
Input of "1340"	→	1340 = (A) × 100	→ (A) = 13 (remainder of 40 is ignored, "1300" is displayed)

[offset value]	+	(data)	[÷]	[divisor]
[0]	+	(A)	[÷]	[100]

Input of "100"	→	100 = (A) / 100	→ (A) = 10000
Input of "550"	→	550 = (A) / 100	→ (A) = 55000
Input of "1340"	→	1340 = (A) / 100	→ (A) = 2928 (A word exceeds 5 digit display)

\*2 Scaling

- If data in the PLC device memory multiplied by the maximum value specified for [Range after Scaling] is greater than a double-word, it cannot be displayed correctly.
- Example: Numerical data display  
When data in the PLC device memory address D100 is "2000" with a range of 0 to 4000 specified for [Range before Scaling] and a range of 0 to 100 specified for [Range after Scaling], "50" is displayed on MONITOUCH.
- Example: When scaling is set for "Entry Target" (entry mode)  
When "25" is entered using a keypad and a range of 0 to 4000 is specified for [Range before Scaling] and a range of 0 to 100 is specified for [Range after Scaling], "1,000" is written to the PLC device memory address D100.

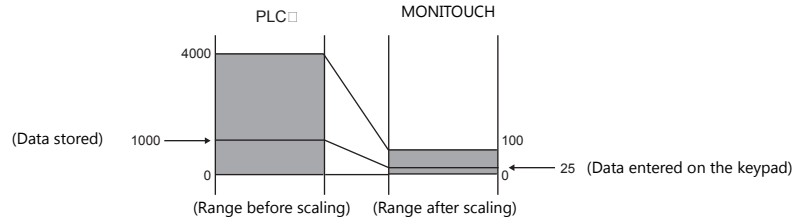

- Notes on using entry targets (entry mode)  
Errors may occur when using entry targets. The entered value will be displayed correctly if [Range before Scaling] is greater than [Range after Scaling].

If [Range before Scaling] > [Range after Scaling], the entered value is displayed correctly.

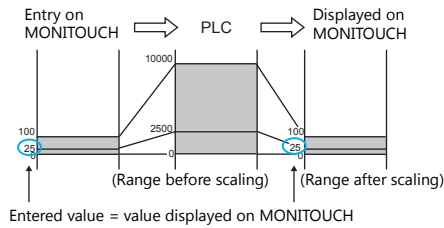

If [Range before Scaling] < [Range after Scaling], the entered value is not displayed correctly.

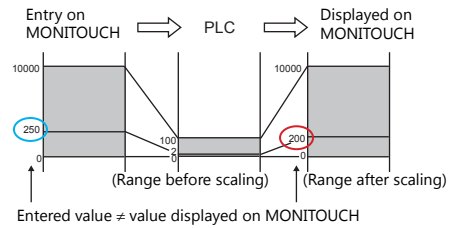

When comparing [Range before Scaling] with [Range after Scaling], remove the decimal point from the display range.

Example: 0 to 10000 for [Range before Scaling] and 0.00 to 500.00 for [Range after Scaling]  
The range after scaling is converted to 0 to 50000, which means [Range before Scaling] < [Range after Scaling] and the entered value is not displayed correctly.

## Interlock

This setting is only available when [Function] for a numerical data display is set to "Entry Target" and the [Display the keyboard] checkbox is selected.

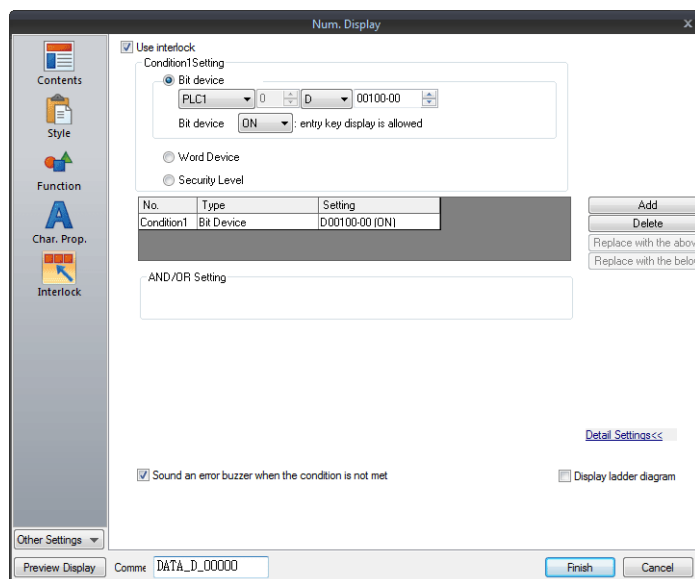

Item	Description
Use interlock	Select this checkbox to add an interlock to the overlap display function of a numerical data display. Click [Add] to set up to 5 conditions that must be satisfied for the interlock to activate.
Condition Setting	Click a condition number to configure a condition that must be satisfied for the interlock to activate.
Bit device	Set the interlock bit address.  Bit device "ON": overlap display is allowed When [Bit device] is OFF, overlap display is prohibited. When [Bit device] is ON, overlap display is allowed.  Bit device "OFF": overlap display is allowed When [Bit device] is OFF, overlap display is allowed. When [Bit device] is ON, overlap display is prohibited.
Word Device	Set the comparison condition expression of the interlock device memory.  Data Length: Set the data length of the condition value. 1-Word/2-Word  Constant Display Type: Set the format of the comparison condition expression. [DEC +/-]/[DEC]/[BCD]  Comparison condition expression: Set a comparison sign, value, and device memory as the conditions for comparison.
Security Level	Used in conjunction with the security function. Allow users of levels higher than the set level to display overlaps. For details on security functions, refer to "5 Security" in the V9 Series Reference Manual 2.
AND/OR Setting	When two or more conditions are set for activating the interlock, set whether to perform AND and OR operations on the conditions.
Detailed Settings	Sound an error buzzer when the condition is not met Set whether an error buzzer sounds when the numerical display is pressed although conditions are not satisfied.  Deselected: A buzzer does not sound.  Selected: A buzzer will sound.
Display ladder diagram	Select this checkbox to display the configured conditions for interlock activation as a ladder diagram.
Display setting details	Select this checkbox to configure condition settings on the ladder diagram.

## Show/Hide

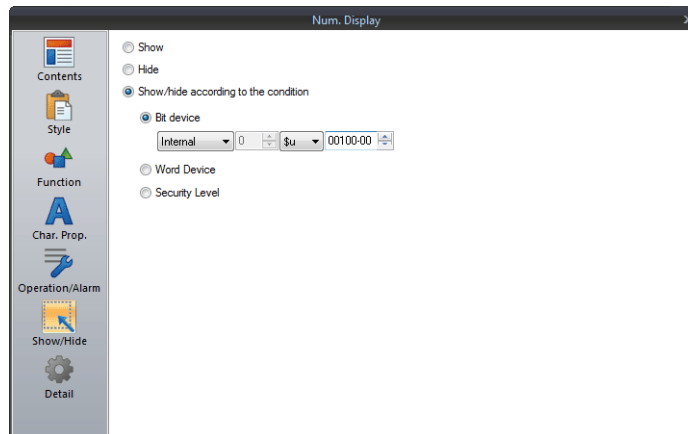

Item		Description
Show		Display the numerical data display on the screen.
Hide		Do not display the numerical data display on the screen.
Show/hide according to the condition	Bit device	Display the switch if the device memory bit is ON and hide the switch if the device memory bit is OFF.
	Word Device	Show the switch if the condition is satisfied and hide the switch if the condition is not satisfied.
		Constant Display Type
	Condition expression	Set a comparison sign, value, and device memory address as the conditions for comparison.
Security Level		This setting is available when using the security function. The “show/hide” attribute can be controlled according to the user’s login level. For details, refer to “5 Security” in the V9 Series Reference Manual 2.

## Detail

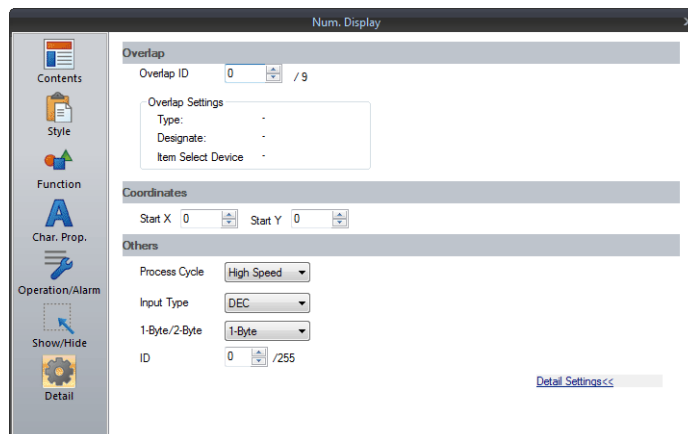

Item		Description
Overlap	Overlap ID (0 - 9)	When the [Function] for a numerical data display is set to “Entry Target” and the [Display the keyboard] checkbox is selected, specify the overlap ID for displaying the keyboard.
Coordinates	Start X/Start Y	Set the display position of the numerical data display using X and Y coordinates.
Others	Process Cycle	Set a cycle for the V9 series to read PLC data while the V9 series is communicating with the PLC. For details, refer to “1.2 Process Cycle”.
	Input Type	Select the code to use when reading data from the PLC device memory address. BCD, DEC, Actual Number *1
	1-Byte / 2-Byte	Select one-byte or two-bytes for displaying numerical data.
	Save an operation log	Used in conjunction with the operation log. For details, refer to “4 Operation Log” in V9 Series Reference Manual 2.
	ID (0 - 255)	Set the ID. For details on IDs, refer to the V9 Series Operation Manual.

\*1 For details on real numbers (floating point data), refer to “5.1.4 Real Numbers (Floating Point Numbers)” page 5-17.

## 5.1.4 Real Numbers (Floating Point Numbers)

MONITOUCH can handle real numbers specified by the IEEE 754 standard (32-bit single precision real number format).

### Overview

#### IEEE 754 standard (32-bit single precision real number format)

32 bits are defined in the following format.

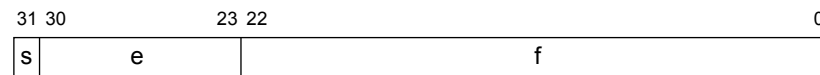

The above format expresses decimal floating-point data as shown below.

- Normalized numbers

$$(-1)^s \times 2^{(e-127)} \times (1.f)$$

Symbol	Name	Description
s	Sign	0: Positive 1: Negative
e	Exponent	0 - 255 * However, if "255" is specified, it cannot be regarded as a decimal floating-point number. If "0" is specified, it is regarded as a denormalized number.
f	Significand	This is a binary fraction less than 1. The final significand can be calculated using the following formula: [1.f] = [1 + f × 2 <sup>-23</sup> ]

- Denormalized numbers (e = 0)

$$(-1)^s \times 2^{-126} \times (0.f)$$

Symbol	Name	Description
s	Sign	0: Positive 1: Negative
e	Exponent	Since e = 0, the exponent will be "-126".
f	Significand	f ≠ 0 This is a binary fraction less than 1. The final significand can be calculated using the following formula: [0.f] = [f × 2 <sup>-23</sup> ]

### Applicable range

$$-3.402823 \times 10^{38} \leq n \leq -1.401298 \times 10^{-45}$$

$$1.401298 \times 10^{-45} \leq n \leq 3.402823 \times 10^{38}$$

(Significant digits: approx. 7 (in decimal))

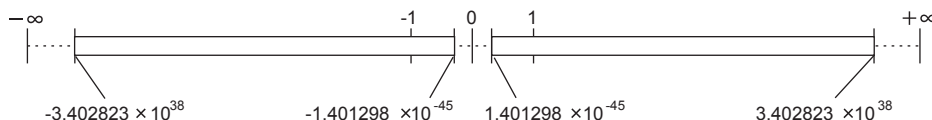

When the value satisfies the following conditions, it cannot be handled as a decimal floating-point number.

- e = 255, f ≠ 0 (non-numerical)
- e = 255, f = 0, s = 0 (+∞)
- e = 255, f = 0, s = 1 (-∞)
- e = (0)

### MONITOUCH display range

$$-9.999999 \times 10^{31} \leq n \leq -1.000000 \times 10^{-31}$$

$$1.000000 \times 10^{-31} \leq n \leq 9.999999 \times 10^{31}$$

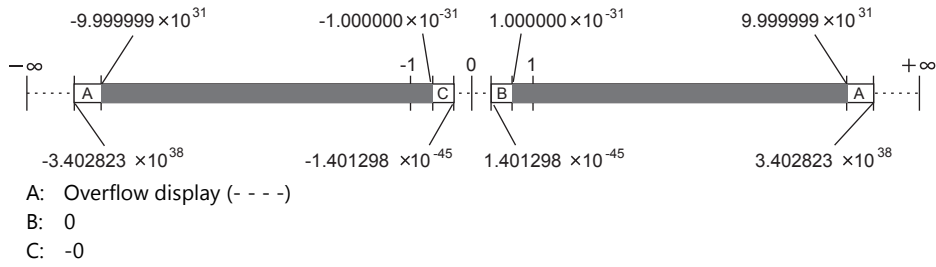

### Decimal Floating-point Data Example

#### Example 1

When the following 32-bit data is displayed as decimal floating-point data, it is calculated as shown below.

31	30	23	22	0
1 1 0 0 0 0 0 0 0 1 0 0 1 0 0 0 0 0 0 0 0 0 0 0 0 0 0 0 0 0 0 0				
s		e		f

10000000(BIN) = 128(DEC)

$$(-1)^s \times 2^{(e-127)} \times (1.f)$$

$$\begin{aligned} &= [1 + f \times 2^{-23}] \\ &= [1 + (2^{22} + 2^{19}) \times 2^{-23}] = [1 + (2^{22-23} + 2^{19-23})] \\ &= [1 + 2^{-1} + 2^{-4}] = [1 + 0.5 + 0.0625] \\ &= 1.5625 \end{aligned}$$

$$2^{(128-127)} = 2^1 = 2$$

$$(-1)^1 = -1 \qquad -1 \times 2 \times 1.5625 = -3.125$$

As a result, a value of "-3.125" is shown on MONITOUCH.

#### Example 2

When the following 32-bit data is displayed as decimal floating-point data, it is calculated as shown below.

31	30	23	22	0
0 1 0 0 0 0 0 0 0 1 0				
s		e		f

10000000(BIN) = 128(DEC)

$$(-1)^s \times 2^{(e-127)} \times (1.f)$$

$$\begin{aligned} &= [1 + f \times 2^{-23}] \\ &= [1 + (2^{21}) \times 2^{-23}] = [1 + 2^{-2}] \\ &= [1 + 0.25] = 1.25 \end{aligned}$$

$$2^{(128-127)} = 2^1 = 2$$

$$(-1)^0 = 1 \qquad 1 \times 2 \times 1.25 = 2.5$$

As a result, a value of "2.5" is shown on MONITOUCH.

## 5.2 Character Display

### 5.2.1 Overview

- Data read from the PLC is displayed in the form of characters on the MONITOUCH screen in real time. ANK codes are assigned to one-byte characters and Shift-JIS codes are assigned to two-byte characters.

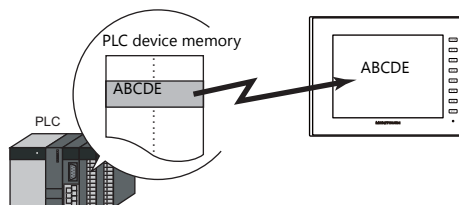

- In addition to using a character display ([Char. Display]) independently, it can also be linked with another part. For example, when a character key set up in [Entry] mode is pressed, the character is entered in the [Char. Display] part specified as "entry target." This is made possible by linking [Char. Display] with the [Entry] mode.

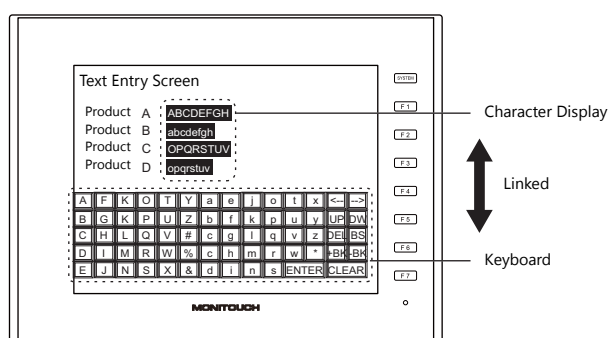

For details, refer to "6.2 Character Input".

- Device memory for offset value designation  
A single character display part can be used to show different data by switching the device memory address assigned to the part. This can help to reduce the number of screens or parts used and facilitate screen maintenance.

For details, refer to [page 5-2](#).

- Device memory for changing attributes  
The attributes (number of bytes or text color) of character display parts are easily changeable while MONITOUCH is in RUN mode.

For details, refer to [page 5-3](#).



## 5.2.2 Detailed Settings

### Contents

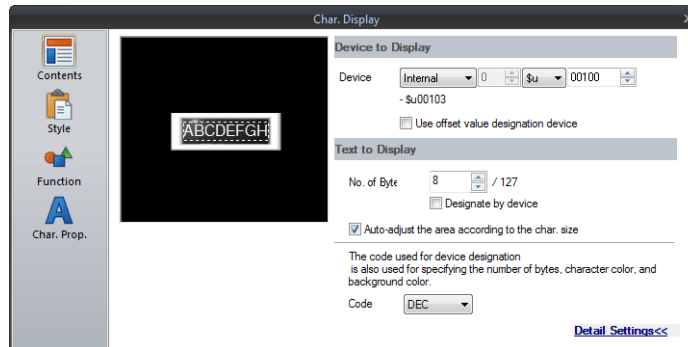

Item	Description								
Device to Display	Device <sup>*1</sup> (base device memory)	Specify the device memory address to use for character display.							
	Use offset value designation device <sup>*2 *3</sup>	Set the device memory address and the code used for storing an offset value with respect to the value in the base device memory. <table border="1" style="margin-left: 20px;"> <thead> <tr> <th>Code</th> <th>Setting Range</th> </tr> </thead> <tbody> <tr> <td>DEC</td> <td>0 - 65535</td> </tr> <tr> <td>BCD</td> <td>0 - 9999</td> </tr> <tr> <td>Real Number Type (DEC)</td> <td>0 - 65535</td> </tr> </tbody> </table>	Code	Setting Range	DEC	0 - 65535	BCD	0 - 9999	Real Number Type (DEC)
Code	Setting Range								
DEC	0 - 65535								
BCD	0 - 9999								
Real Number Type (DEC)	0 - 65535								
Text to Display	No. of Bytes (1 - 127)	Specify the number of bytes used by this part.							
	Designate by device <sup>*4</sup>	Select this checkbox to change the number of bytes according to the value specified for the device memory address.							
	Auto-adjust the area according to the char. size	Select this checkbox to automatically adjust the item size based on the [Digits] and [Decimal Point] settings.							
	Code	When a [Designate by device] checkbox is selected, set the code used when reading values from the device. This setting applies to [No. of Bytes], [Char. Color], and the [Background] color.							

\*1 Code used for storing text of character display parts

- 1-byte characters: ANK code
- 2-byte characters: Shift-JIS code

\*2 The device memory for offset value designation is read every cycle, regardless of the item processing cycle. Screen updates depend on the setting of the [Redraw the screen] checkbox in [Screen Setting] → [Screen Setting] → [Unhide] → [Unhide Items].

- Selected:  
Update the screen when the value in the device memory for offset value designation changes.  
Only update the items on the screen whose value changed in the device memory for offset value designation (the screen is not redrawn).
- Unselected:  
The screen is updated at the following times.  
Screen change/screen redraw/multi-overlap change (when there are parts placed on multi-overlap)

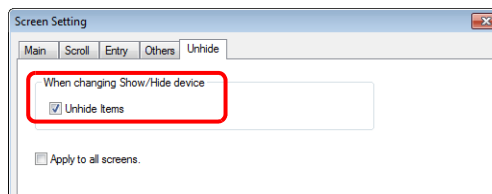

\*3 Notes on using the device memory for offset value designation

- When the screen is updated, the device memory for offset value designation is read for the items placed on the screen. This means that for a screen that includes multiple addresses of the device memory for offset value designation, the updated screen is displayed upon completion of reading all of these device memory addresses. If screen updates are taking too long, use of the internal device memory is recommended.
- When setting offset values on a screen, the setting needs to be completed before the screen is changed to another screen. In a case where an offset value is designated in an OPEN macro, the offset value is not valid when the screen is open, but becomes valid when the screen is updated.
- An error occurs if a value set to the device memory for offset value designation is outside the permissible range. Observe the specified range for setting.  
PLC device memory: Communication error Format  
Internal device memory: Error: 46

\*4 For details on the method for specifying attributes using device memory, refer to "Specifying attributes using device memory" page 5-21.

## Specifying attributes using device memory

When a [Designate by device] checkbox in [Contents] → [Detail Settings] or a [Designate by device] checkbox in [Char. Prop.] → [Detail Settings] is selected, the corresponding attribute can be changed by specifying a value using a device memory address.

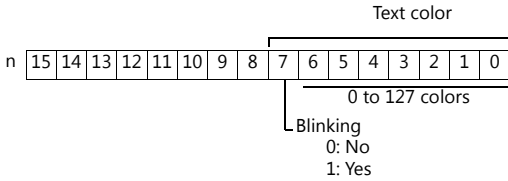
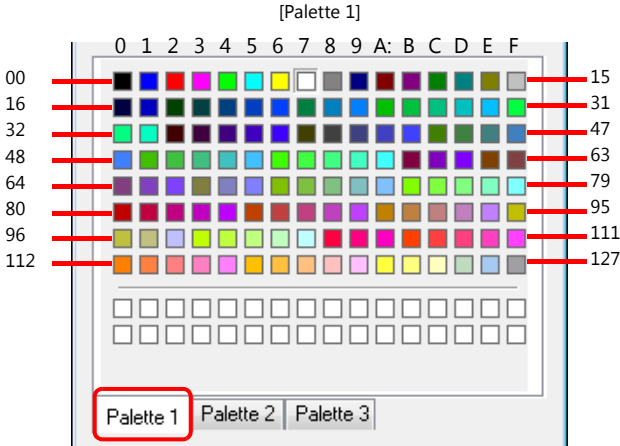
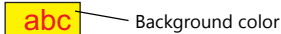
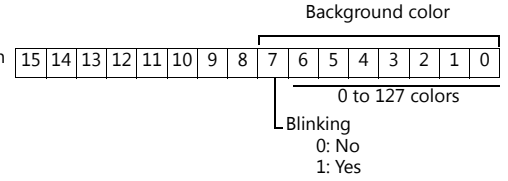
Item	No. of Bytes	Description
Contents	No. of Bytes	Specify the number of bytes of the character display. No. of Bytes: 1 to 127 <b>* Regardless of the setting for [No. of Bytes], 127 bytes (64 words) will always be read.</b>
Char. Prop.	Char. Color	Set the color for text.  Bits 0 to 6: Color Bit 7 : Blinking (0: No, 1: Yes)    A color can be selected from the 128 colors (and blinking) on [Palette 1] in the [Custom Color] window. Colors correspond to the following color codes.    [Palette 1] 0 1 2 3 4 5 6 7 8 9 A: B C D E F 00 15 16 31 32 47 48 63 64 79 80 95 96 111 112 127 Palette 1 Palette 2 Palette 3
Background	Background	Specify the background color of text.  Bits 0 to 6: Color Bit 7 : Blinking (0: No, 1: Yes)    A color can be selected from the 128 colors (and blinking) on [Palette 1] in the [Custom Color] window. For details on color codes, refer to the "Char. Color" section. <b>* However, note that the background color setting does not take effect when [Char. Prop.] → [Style] is set to "transparent".</b>

**Notes on changing attributes using device memory**

- The update timing depends on the setting of [Detail] → [Process Cycle] of each part.
- For parts with a frame, the frame size does not change according to the setting of [Digits], [Decimal Point], or [Display Format].  
For this reason, the maximum number of bytes in the screen program must be set in advance.
- When [Char. Prop.] → [Style] is set to “not transparent”, the drawing range of the background color will be affected by changes to the number of bytes. This means that if the set number of bytes decreases, the background color will remain on the screen.  
For this reason, the maximum number of bytes in the screen program must be set in advance. Alternatively, update the display by executing the “SYS (RESET\_SCRN)” macro command or by changing the screen.
- The “CHG\_DATA” macro command cannot be used with numerical data displays for which a [Designate by device] checkbox is selected.
- When “Entry Target” is set for [Function], the display is switched when the cursor is moved from the display field.

**Style**

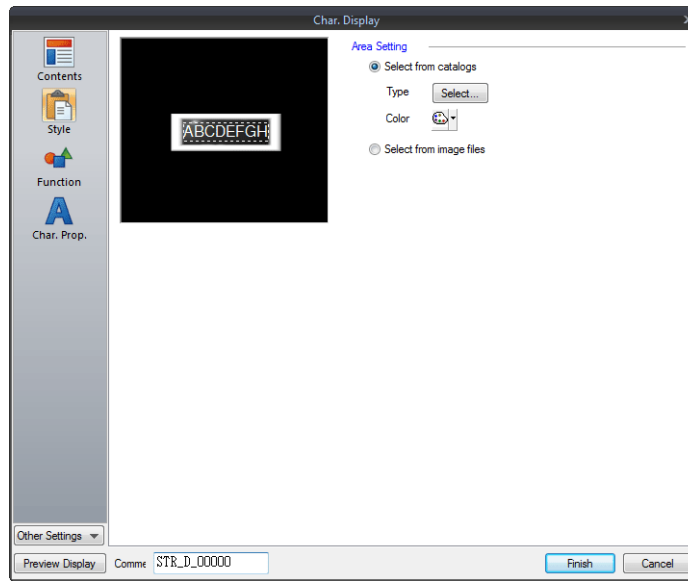

Item		Description
Area Setting	Select from catalogs	Select the part design. After selecting the part, select the part color.
	Select from image files	Select a PNG file.

## Function

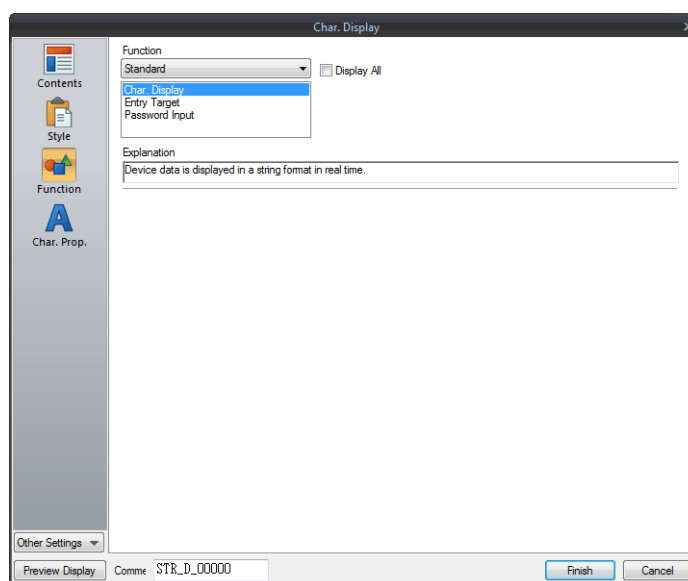

Item		Description
Function		Set the function of the character display.
Standard	Char. Display	Display device memory values on the character display in real time.
	Entry Target	Used in conjunction with the entry function. For details, refer to <a href="#">"6.2 Character Input"</a> .
	Password Input	
Display All		Select this checkbox to display all of the available character display functions. <sup>*1</sup>

\*1 The following function is added when the [Display All] checkbox is selected.

Name	Description	Linked Part	Refer to
Standard	Entry Display Part	Entry	<a href="#">page 6-20</a>
	Readings Registration		
	Phrase Registration		
Alarm	Status Display	Alarm	<a href="#">page 8-1</a>

## Char. Prop.

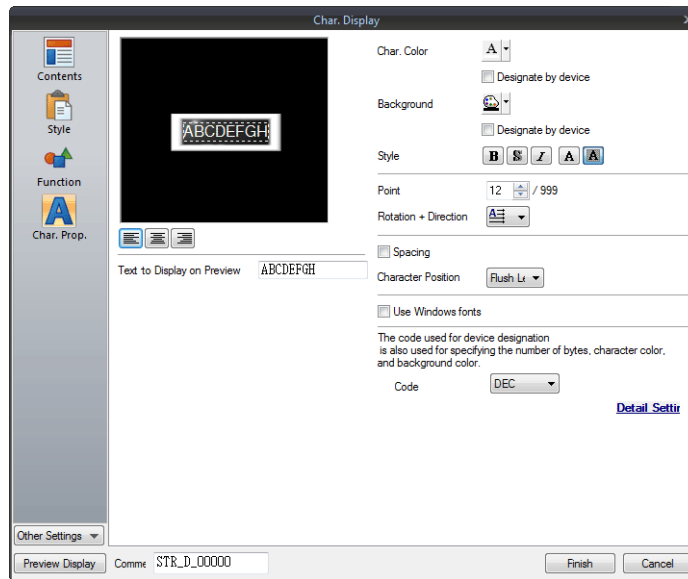

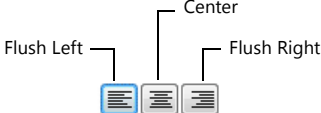
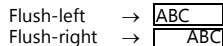
Item	Description
Alignment	Set the text alignment. 
Text to Display on Preview	This item is available when the [Display for the editor] checkbox is selected on the [View] → [Display Environment] → [Display] tab. Set the text to display using the editor.
Char. Color	Set the color for text.
Designate by device <sup>*1</sup>	Select this checkbox to change the text color according to the value specified for the device memory address.
Background	Set the background color of text.
Designate by device <sup>*1</sup>	Select this checkbox to change the background color according to the value specified for the device memory address.
Style	Set the text style.
Character Size (1 - 8)	Specify the enlargement factor for text.
Point (6 - 999)	Set the text size.
Rotation + Direction	Set the combination of text rotation and direction. Four combinations are displayed in the drop-down menu.  When selecting an option other than the above, click the icon at the bottom. The window that allows selection from all options is displayed.
Spacing	Select this checkbox to specify the spacing between characters.
Character Position	Select [Flush Left] or [Flush Right].  
Use Windows fonts	Select this checkbox to use a Windows font.
Smooth Font <sup>*2</sup>	When "Windows Font" is selected, select this checkbox to smooth the edges of text. (Only settable for TrueType Windows fonts.)
Windows Font Registration <sup>*3</sup>	Register a Windows font to use to display text.

<sup>\*1</sup> For details on the method for specifying attributes using device memory, refer to "Specifying attributes using device memory" page 5-7.

<sup>\*2</sup> Cannot be set to transparent.

<sup>\*3</sup> For details on registering Windows fonts, refer to the V9 Series Operation Manual.

## Interlock

This setting is only available when [Function] for a character display part is set to "Entry Target" and the [Display the keyboard] checkbox is selected.

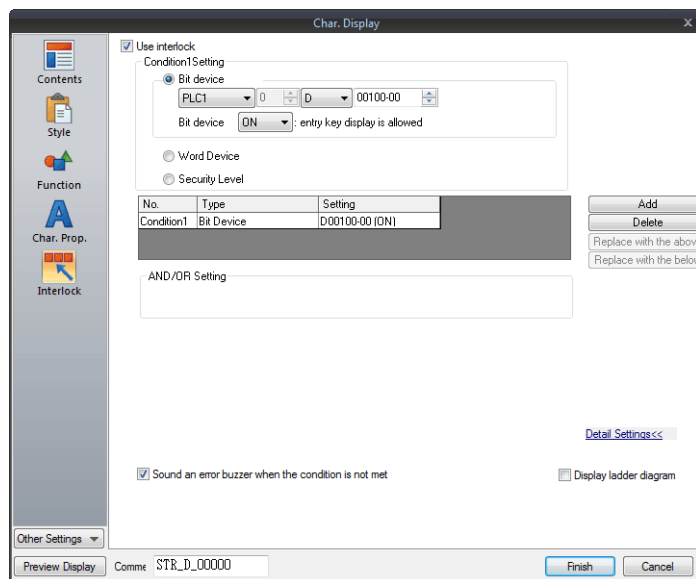

Item	Description
Use interlock	Select this checkbox to add an interlock to the overlap display function of a character display. Click [Add] to set up to 5 conditions that must be satisfied for the interlock to activate.  For details on each item, refer to <a href="#">"Interlock" page 5-15</a> .

## Show/Hide

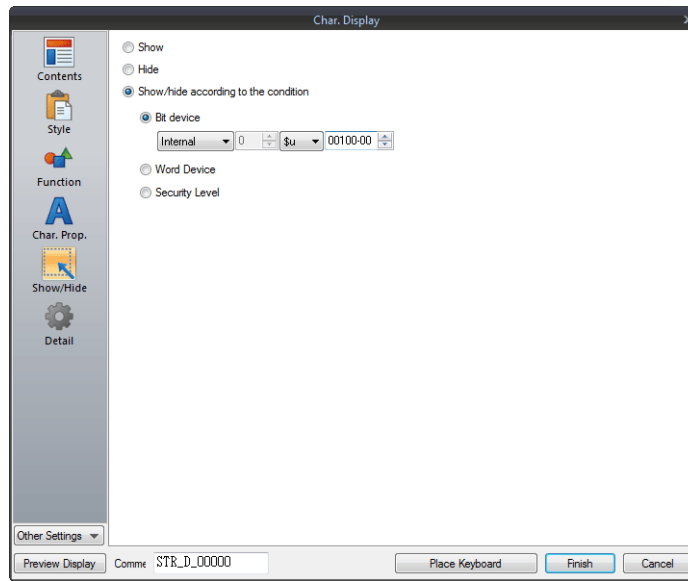

Item		Description			
Show		Display the numerical data display on the screen.			
Hide		Do not display the numerical data display on the screen.			
Show/hide according to the condition	Bit device	Display the switch if the device memory bit is ON and hide the switch if the device memory bit is OFF.			
	Word Device	Show the switch if the condition is satisfied and hide the switch if the condition is not satisfied.			
		<table border="1"> <tr> <td>Constant Display Type</td> <td>Select the data type of the conditional expression. [DEC+ -]/[DEC]/[BCD]</td> </tr> <tr> <td>Condition Expression</td> <td>Set a comparison sign, value, and device memory address as the conditions for comparison.</td> </tr> </table>	Constant Display Type	Select the data type of the conditional expression. [DEC+ -]/[DEC]/[BCD]	Condition Expression
	Constant Display Type	Select the data type of the conditional expression. [DEC+ -]/[DEC]/[BCD]			
Condition Expression	Set a comparison sign, value, and device memory address as the conditions for comparison.				
Security Level	This setting is available when using the security function. The "show/hide" attribute can be controlled according to the user's login level. For details, refer to "5 Security" in the V9 Series Reference Manual 2.				

## Detail

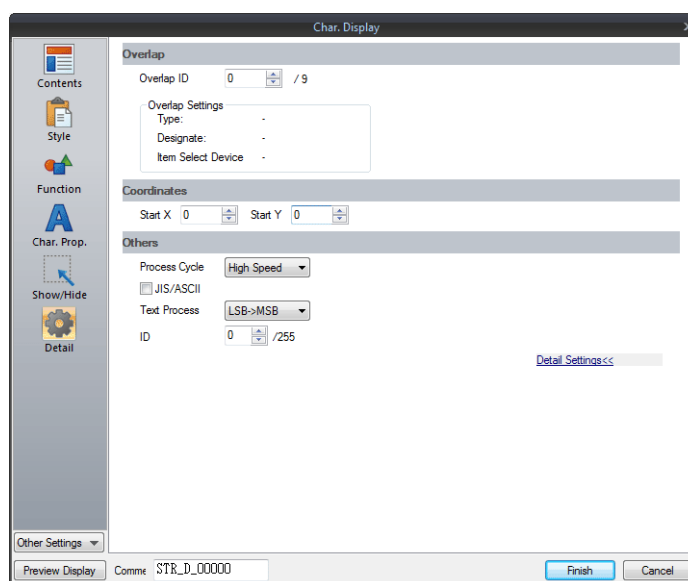

Item		Description																
Overlap	Overlap ID (0 - 9)	When the [Function] for a numerical data display is set to "Entry Target" and the [Display the keyboard] checkbox is selected, specify the overlap ID for displaying the keyboard.																
Coordinates	Start X/Start Y	Set the display position of the character display using X and Y coordinates.																
Others	Process Cycle	Set a cycle for the V9 series to read PLC data while the V9 series is communicating with the PLC. For details, refer to "1.2 Process Cycle".																
	Text Process	Set the order of the first and second bytes in words. <div style="display: flex; justify-content: space-around; align-items: center;"> <div style="text-align: center;"> <p>[LSB → MSB]</p> <table border="1" style="border-collapse: collapse;"> <tr> <td style="width: 20px; text-align: center;">15</td> <td style="width: 40px; text-align: center;">MSB</td> <td style="width: 40px; text-align: center;">LSB</td> <td style="width: 20px; text-align: center;">0</td> </tr> <tr> <td></td> <td style="text-align: center;">2nd byte</td> <td style="text-align: center;">1st byte</td> <td></td> </tr> </table> </div> <div style="text-align: center;"> <p>[MSB → LSB]</p> <table border="1" style="border-collapse: collapse;"> <tr> <td style="width: 20px; text-align: center;">15</td> <td style="width: 40px; text-align: center;">LSB</td> <td style="width: 40px; text-align: center;">MSB</td> <td style="width: 20px; text-align: center;">0</td> </tr> <tr> <td></td> <td style="text-align: center;">1st byte</td> <td style="text-align: center;">2nd byte</td> <td></td> </tr> </table> </div> </div>	15	MSB	LSB	0		2nd byte	1st byte		15	LSB	MSB	0		1st byte	2nd byte	
	15	MSB	LSB	0														
		2nd byte	1st byte															
15	LSB	MSB	0															
	1st byte	2nd byte																
Save an operation log	Used in conjunction with the operation log. For details, refer to "4 Operation Log" in V9 Series Reference Manual 2.																	
ID (0 - 255)	Set the ID. For details on IDs, refer to the V9 Series Operation Manual.																	



## 5.3 Message Display

### 5.3.1 Overview

- Use the message edit screen to register messages for display on the screen in advance. When a message registration number is specified for a device memory address, the corresponding message is displayed on the screen in real time.

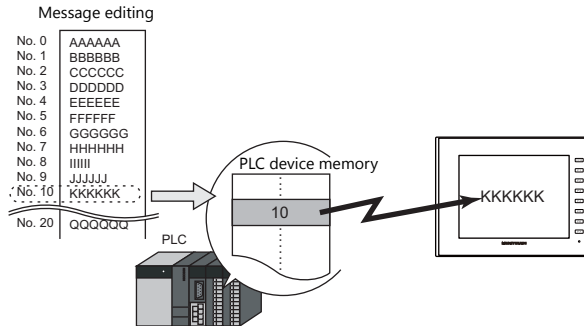

- Single line message can be displayed at any position.

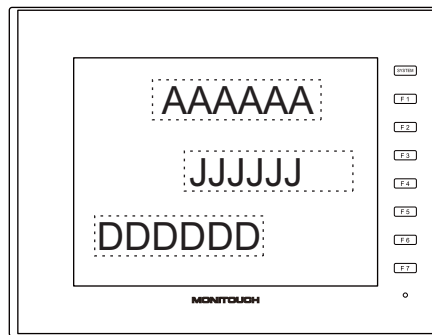

## 5.3.2 Detailed Settings

### Device Memory

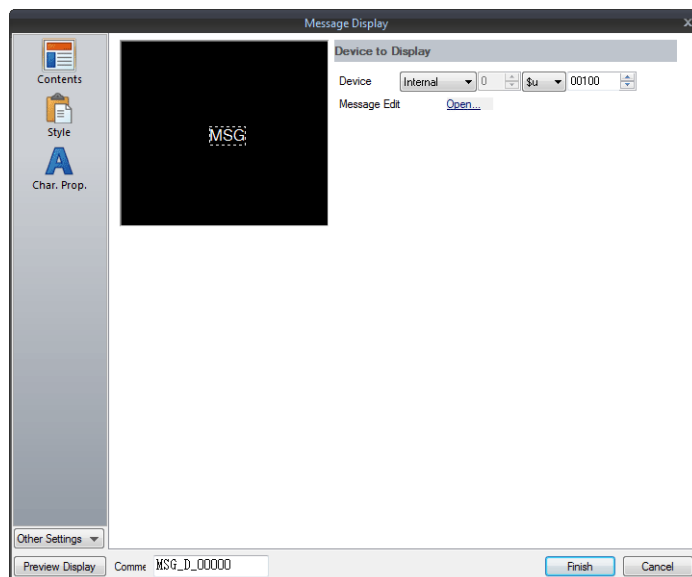

Item	Description
Device	One word is used for device memory specification. The message that corresponds to data contained at the specified device memory address is displayed on the screen. <b>* Specify a message number using its absolute address (range: 0 to 32767). For details on absolute addresses, refer to the V9 Series Operation Manual.</b>
Message Edit	Click [Open] to display the [Message Edit] window. For details on editing messages, refer to the V9 Series Operation Manual.

### Style

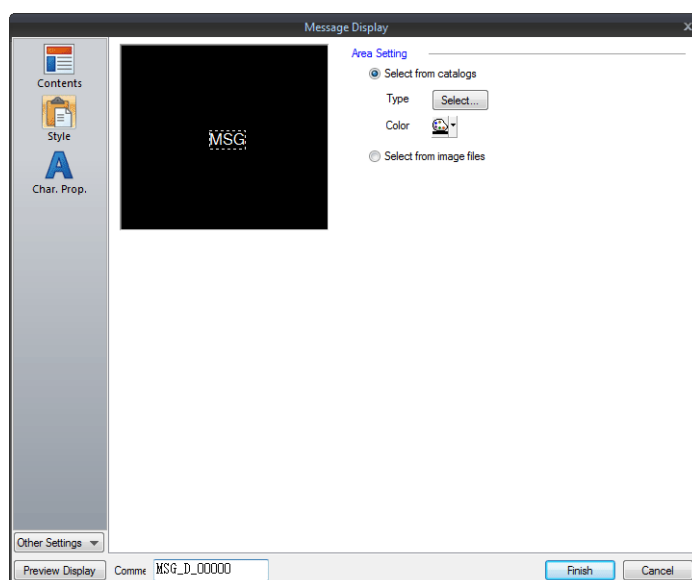

Item	Description	
Area Setting	Select from catalogs	Select the part design. After selecting the part, select the part color.
	Select from image files	Select a PNG file.

## Char. Prop.

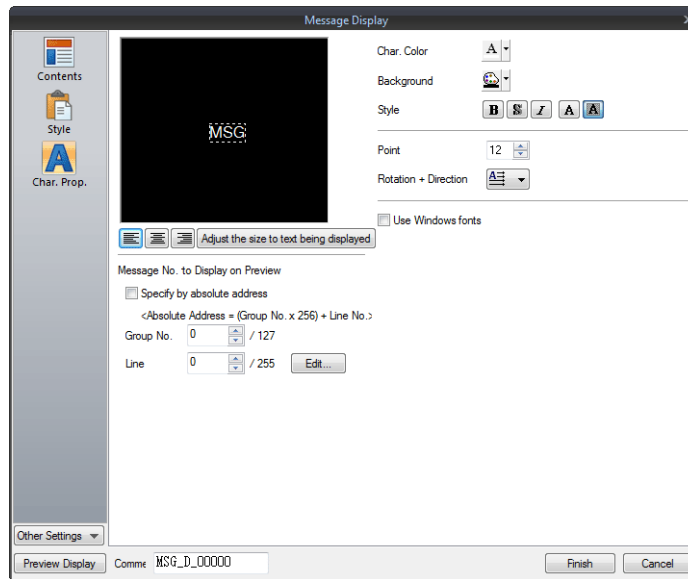

Item	Description
Alignment	<p>Set the text alignment.</p>
Message No. to Display on Preview <input type="checkbox"/> Specify by absolute address	<p>This item is available when the [Display for the editor] checkbox is selected on the [View] → [Display Environment] → [Display] tab. Set the message to display using the editor.</p> <p>Unselected: Specify the message using the group number and line number.</p> <p>Selected: Specify the message using the absolute address. (absolute address = (group number × 256) + line number)</p>
Char. Color	Set the color for text.
Background	Set the background color of text.
Style	Set the text style.
Character Size (1 - 8)	Specify the enlargement factor for text.
Point (6 - 999)	Set the text size.
Rotation + Direction	<p>Set the combination of text rotation and direction. Four combinations are displayed in the drop-down menu.</p> <p>When selecting an option other than the above, click the icon at the bottom. The window that allows selection from all options is displayed.</p>
Use Windows fonts	Select this checkbox to use a Windows font.

## Show/Hide

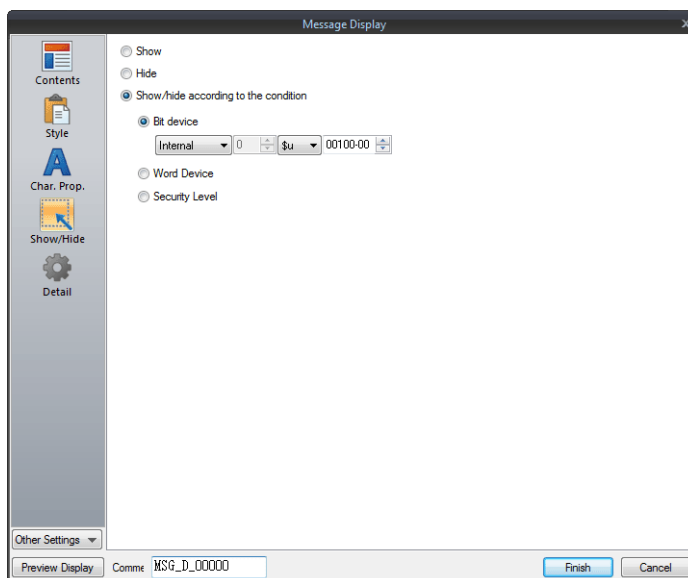

Item		Description			
Show		Display the numerical data display on the screen.			
Hide		Do not display the numerical data display on the screen.			
Show/hide according to the condition	Bit device	Display the switch if the device memory bit is ON and hide the switch if the device memory bit is OFF.			
	Word Device	Show the switch if the condition is satisfied and hide the switch if the condition is not satisfied.			
		<table border="1"> <tr> <td>Constant Display Type</td> <td>Select the data type of the conditional expression. [DEC+ -]/[DEC]/[BCD]</td> </tr> <tr> <td>Condition expression</td> <td>Set a comparison sign, value, and device memory address as the conditions for comparison.</td> </tr> </table>	Constant Display Type	Select the data type of the conditional expression. [DEC+ -]/[DEC]/[BCD]	Condition expression
	Constant Display Type	Select the data type of the conditional expression. [DEC+ -]/[DEC]/[BCD]			
Condition expression	Set a comparison sign, value, and device memory address as the conditions for comparison.				
Security Level	This setting is available when using the security function. The "show/hide" attribute can be controlled according to the user's login level. For details, refer to "5 Security" in the V9 Series Reference Manual 2.				

## Detail

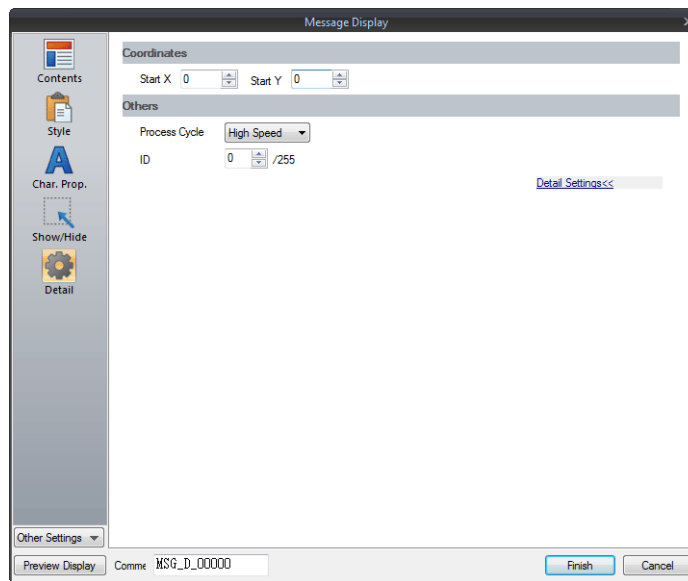

Item		Description
Coordinates	Start X/Start Y	Set the display position of the message display using X and Y coordinates.
Others	Process Cycle	Set a cycle for the V9 series to read PLC data while the V9 series is communicating with the PLC. For details, refer to <a href="#">"1.2 Process Cycle"</a> .
	ID (0 - 255)	Set the ID. For details on IDs, refer to the V9 Series Operation Manual.

## 5.4 Table Data Display

### 5.4.1 Overview

- Sets of data can be displayed in tabular format with ease.
- Select from number display, character display, message display, or text for the data display part.
- The properties of multiple data display parts can be changed at once.
- Average, maximum, minimum, and total values can be displayed.
- Table data display parts can be set as an entry target for entry mode.

	No.1	No.2	No.3	No.4	No.5	Average
<b>1</b>	100	150	120	130	200	140
<b>2</b>	120	100	180	190	200	158
<b>3</b>	130	120	160	100	150	132
<b>4</b>	50	60	40	150	20	64

### 5.4.2 Table Data Settings

#### Lines and Columns

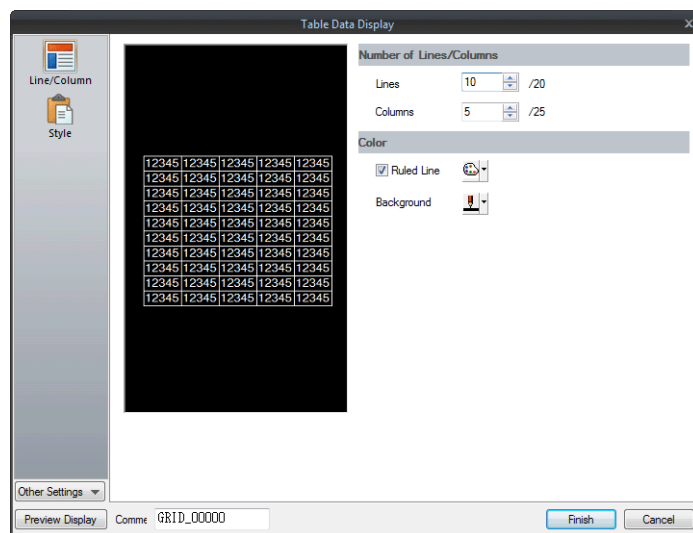

Item		Description
Number of Lines/Columns	Lines (1 to 20)	Specify the number of lines.
	Columns (1 to 25)	Specify the number of columns.
Color	Ruled Line	Select this checkbox to display ruled lines. The color of ruled lines can be specified when the checkbox is selected.
	Background	Select a background color for the table data.

## Style

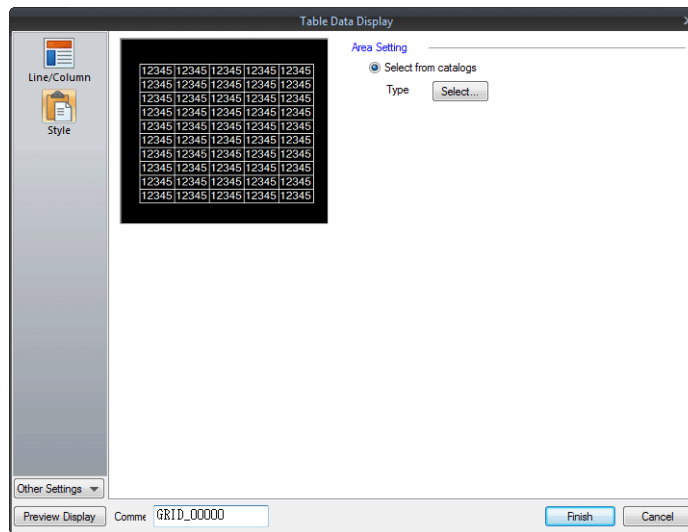

Item		Description
Area Setting	Select from catalogs	Select the part design.

## Detail

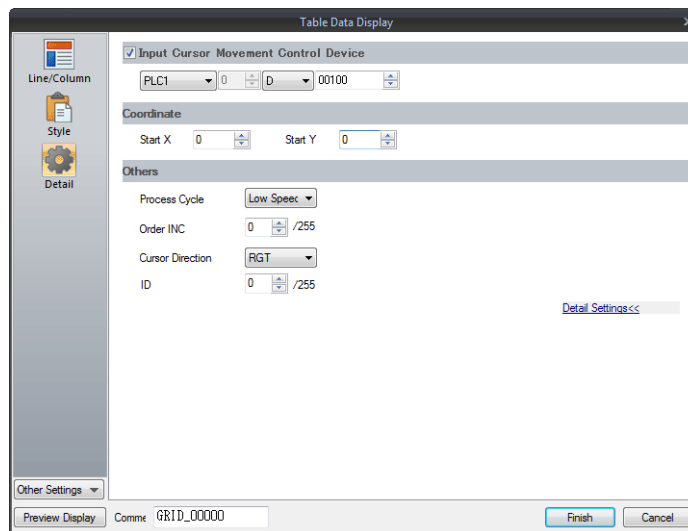

Item		Description
Input Cursor Movement Control Device		Select this checkbox when using the item selection function. For details on the item selection function, refer to "6.3.1 Item Select Function".
Coordinate	Start X/Start Y	Set the display position of the table data display using X and Y coordinates.
Others	Process Cycle	Set a cycle for the V9 series to read PLC data while the V9 series is communicating with the PLC. For details, refer to "1.2 Process Cycle".
	Order INC (0 - 255)	When the table data display contains multiple table data display parts for which [Function] is set to "Entry Target", specify the order of precedence of each table data display part.
	Cursor Direction (RGT/DWN)	This setting is available when [Cursor Moved by] is set to "UP/DW Switch" in the entry mode and bit 14 (cursor movement) of [Control Device] is set to ON. This option determines the direction in which the cursor moves when the [Write] key is pressed.
	ID (0 - 255)	Set the ID. For details on IDs, refer to the V9 Series Operation Manual.

## 5.4.3 Numerical Data Display Settings

Each data cell can be selected to display a settings window for the corresponding cell.  
(For details on the editing procedure, refer to the V9 Series Operation Manual.)  
This section explains the case when [Num. Display] is selected for [Select Type].

### Select Type

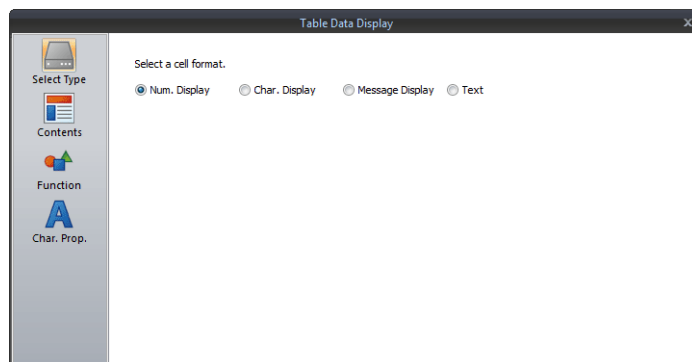

Item	Description
Num. Display Char. Display Message Display Text	Select [Num. Display].

### Contents

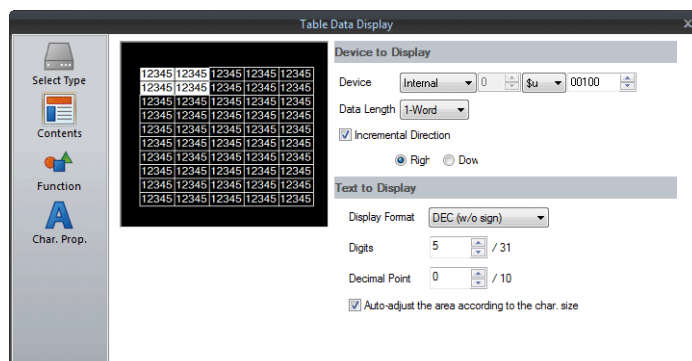

Item	Description	
Device to Display	Device	Specify the device memory address to use for numerical data display.
	Data Length *1 1-Word/2-Word	Select the data length used for this part.
	Incremental Direction *2	This setting is available when multiple data in the table are selected. For details, refer to <a href="#">page 5-37</a> .
Text to Display	Display Format *1	Select the format of numbers to be displayed on the screen.
	Digits *3	Specify the number of digits for the numerical data display.
	Decimal Point	Specify the decimal place. The number of decimal places must be smaller than the number of digits. When no decimal point is required, set "0".
	Auto-adjust the area according to the char. size	Select this checkbox to automatically adjust the item size based on the [Digits] and [Decimal Point] settings.

\*1 Relationship between data length and display format

Code Format	1-word Display Range	2-word Display Range
DEC (w/o sign)	0 to 65535	0 to 4294967295
DEC (with sign -)	-32768 to 32767	-2147483648 to 2147483647
DEC (with sign +-)	-32768 to +32767	-2147483648 to +2147483647
HEX	0 to FFFF	0 to FFFFFFFF
OCT	0 to 177777	0 to 3777777777
BIN (Binary)	0 to 1111111111111111	0 to 11111111111111111111111111111111



\*2 Incremental Direction

Example:  
Device memory: D200  
[Incremental Direction] checkbox: selected (Down)

Select

12345	12345	12345	12345
12345	12345	12345	12345
12345	12345	12345	12345
12345	12345	12345	12345
12345	12345	12345	12345

The device memory addresses of the selected data display cells change as shown below.

12345	12345	12345	12345
12345	D200	D203	12345
12345	D201	D204	12345
12345	D202	D205	12345
12345	12345	12345	12345

\*3 Digits

For details, refer to [page 5-6](#).

## Function

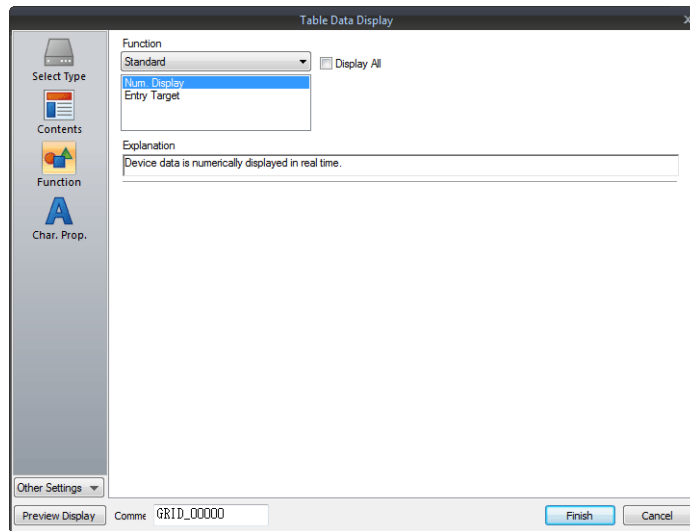

Item	Description		
Function	Standard	Numerical data display	Set the type of operation performed by the numerical data display.
		Entry Target	Display device memory values on the numerical data display in real time.
			Used in conjunction with the entry function. For details, refer to "6.1 Numerical Data Entry".
Display All			Select this checkbox to display all of the available numerical data display functions. <sup>*1</sup>

\*1 The following functions are added when the [Display All] checkbox is selected.

Name	Description		
Standard	Mean Value Display	Start X/Y, End X/Y *2	Display the mean value of the selected data range.
	Max. Value Display Part	Start X/Y, End X/Y *2	Display the maximum value of the selected data range.
	Min. Value Display Part	Start X/Y, End X/Y *2	Display the minimum value of the selected data range.
	Total Display	Start X/Y, End X/Y *2	Display the total value of the selected data range.

\*2 Start X/Y, End X/Y

X:1,Y:1	X:2,Y:1	X:3,Y:1
X:1,Y:2	X:2,Y:2	X:3,Y:2
X:1,Y:3	X:2,Y:3	X:3,Y:3
X:1,Y:4	X:2,Y:4	X:3,Y:4
X:1,Y:5	X:2,Y:5	X:3,Y:5

Select

12345	12345	12345
12345	12345	12345
12345	12345	12345
12345	12345	12345
12345	12345	12345

This numerical data display shows the mean value of the selected data range.  
Display Function: Mean Value Display  
Start X: 2, Y: 1  
End X: 2, Y: 4

## Char. Prop.

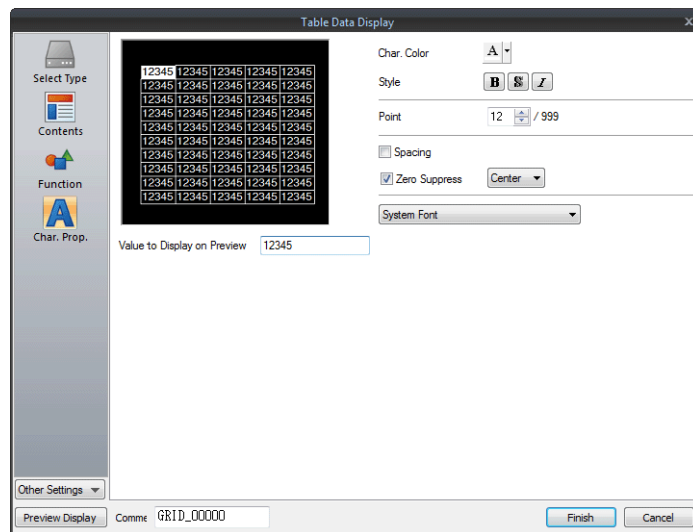

Item	Description
Value to Display on Preview	This item is available when the [Display for the editor] checkbox is selected on the [View] → [Display Environment] → [Display] tab. Set the value to display using the editor.
Char. Color	Set the color for text.
Background	Set the background color of text.
Style	Set the text style.
Character Size (1 - 8)	Specify the enlargement factor for text.
Point (6 - 999)	Set the text size.
Zero Suppress	Select this checkbox to use zero suppression.  <div style="text-align: center;"> </div> <p>When this checkbox is selected, specify [Flush Left], [Center] or [Flush Right].</p> <div style="text-align: center;">           Flush Left → <input type="text" value="123"/>            Center → <input type="text" value="123"/>            Flush Right → <input type="text" value="123"/> </div>
System Font Windows Font 7-segment Font	Select the font to use for the numerical data display. When "7-segment Font" is selected, select the [Display light-out segments] checkbox to display unlit segments.
Smooth Font *1	When "Windows Font" is selected, select this checkbox to smooth the edges of text. (Only settable for TrueType Windows fonts.)
Display light-out segments *2	When "7-segment Font" is selected, select this checkbox to display unlit segments.

\*1 Cannot be set to transparent.

\*2 Featuring digital display fonts by Yourname, Inc.

## Operation/Alarm

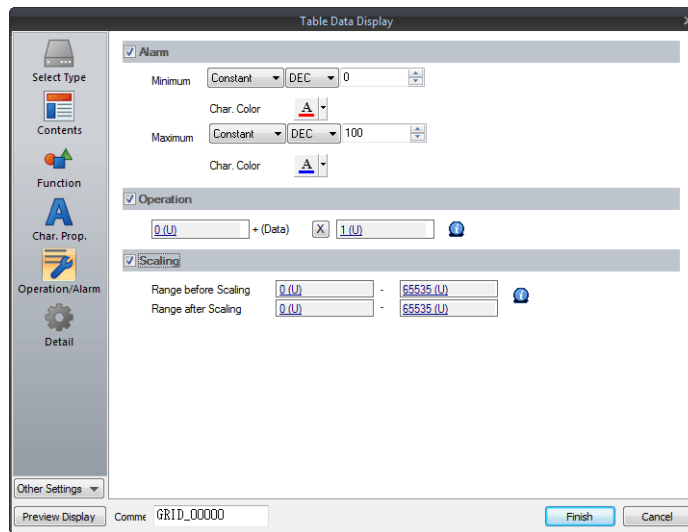

Item	Description
Alarm	Select this checkbox to display data in a different color when it exceeds or falls short of a specific range. When "Entry Target" is selected for [Function], the range of values that can be entered using a keypad can be set. For details on numerical value entry, refer to "6.1 Numerical Data Entry".
Minimum	Set the minimum value used to trigger an alarm.
Char. Color	Set the color for text.
Maximum	Set the maximum value used to trigger an alarm.
Char. Color	Set the color for text.
Operation <sup>*1</sup>	Select this checkbox to perform an operation on the value of the device memory address specified in [Contents].
Scaling <sup>*2</sup>	Select this checkbox to display data after automatically converting the data read from the PLC ([Range before Scaling]) to the specified range ([Range after Scaling]). This eliminates the need for correction programs for data read from the PLC when displaying information such as temperature, rotation speed, etc.
Range before Scaling	Specify the data to be read from the PLC.
Range after Scaling	Specify the range of data to be shown on MONITOUCH.

\*1 For details on operations, refer to [page 5-13](#).

\*2 For details on scaling, refer to [page 5-14](#).

## Detail

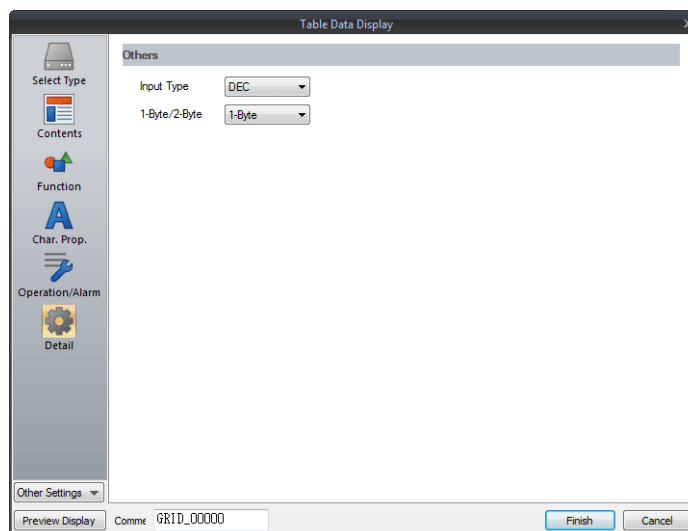

Item	Description
Others	Select the code to use when reading data from the PLC device memory address. BCD/DEC
1-Byte / 2-Byte	Select one-byte or two-bytes for displaying numerical data.

## 5.4.4 Character Display Settings

Each data cell can be selected to display a settings window for the corresponding cell.  
 (For details on the editing procedure, refer to the V9 Series Operation Manual.)  
 This section explains the case when [Char. Display] is selected for [Select Type].

### Select Type

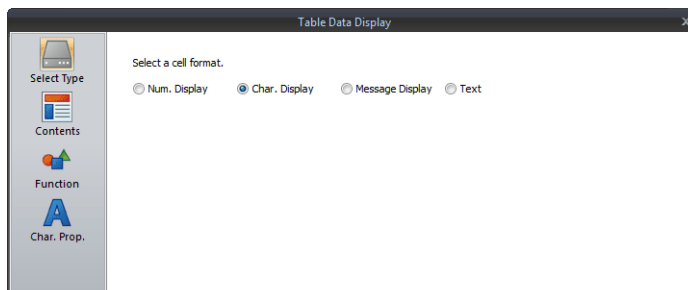

Item	Description
Num. Display Char. Display Message Display Text	Select [Char. Display].

### Contents

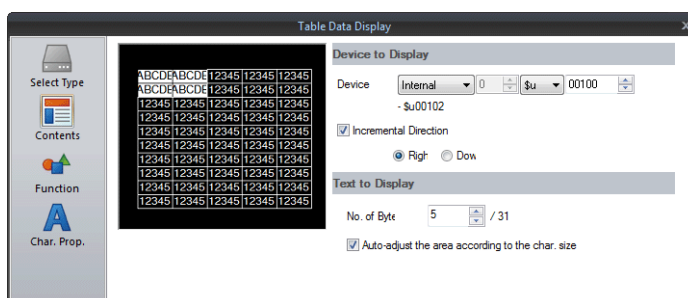

Item	Description	
Device to Display	Device	Specify the device memory address to use for character display.
	Incremental Direction	This setting is available when multiple data in the table are selected. For details, refer to <a href="#">page 5-37</a> .
Text to Display	No. of Bytes	Specify the number of characters to be displayed.
	Auto-adjust the area according to the char. size	Select this checkbox to automatically adjust the item size based on the [Digits] and [Decimal Point] settings.

### Function

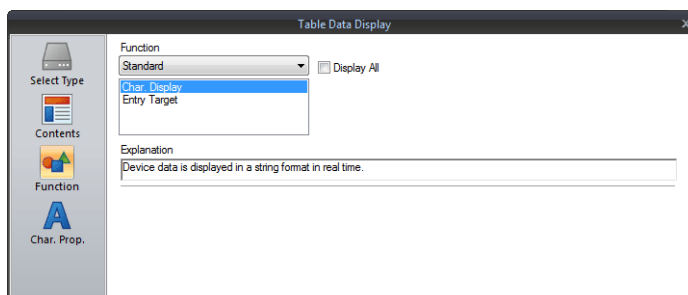

Item	Description	
Function	Standard	Set the function of the character display.
	Char. Display	Display device memory values on the character display in real time.
	Entry Target	Used in conjunction with the entry function. For details, refer to <a href="#">"6.2 Character Input"</a> .

## Char. Prop.

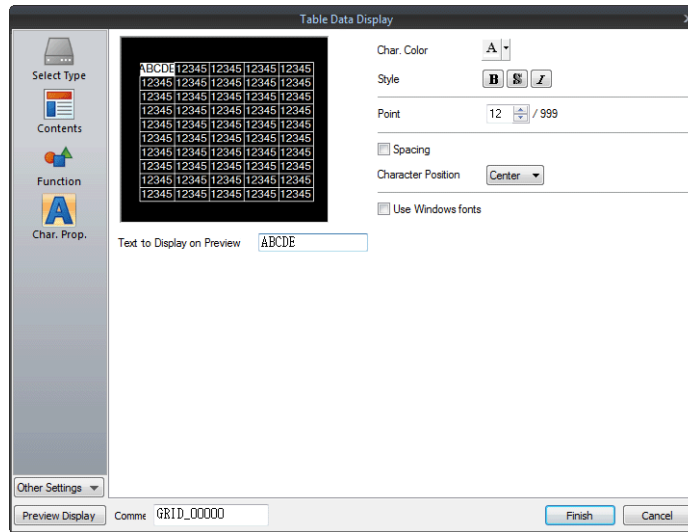

Item	Description			
Text to Display on Preview	This item is available when the [Display for the editor] checkbox is selected on the [View] → [Display Environment] → [Display] tab. Set the text to display using the editor.			
Char. Color	Set the color for text.			
Background	Set the background color of text.			
Style	Set the text style.			
Character Size (1 - 8)	Specify the enlargement factor for text.			
Point (6 - 999)	Set the text size.			
Character Position	The character position in the cell can be selected.  Flush Left → <table border="1"><tr><td>123</td></tr></table> Center → <table border="1"><tr><td>123</td></tr></table> Flush Right → <table border="1"><tr><td>123</td></tr></table>	123	123	123
123				
123				
123				
Use Windows fonts	Select this checkbox to use a Windows font.			
Smooth Font *1	When "Windows Font" is selected, select this checkbox to smooth the edges of text. (Only settable for TrueType Windows fonts.)			
Windows Font Registration *2	Register a Windows font to use to display text.			

\*1 Cannot be set to transparent.

\*2 For details on registering Windows fonts, refer to the V9 Series Operation Manual.

## Detail

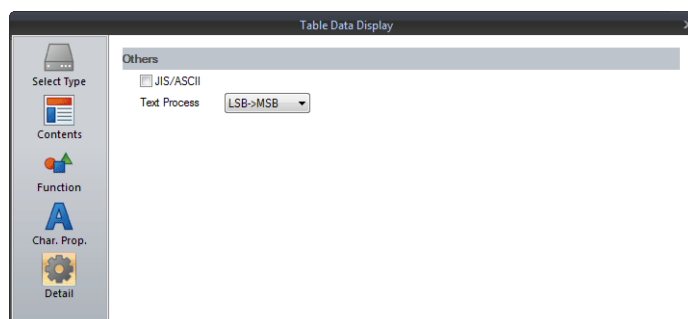

Item	Description																		
Others	<table border="1"> <tr> <td>Text Process</td> <td>Set the order of the first and second bytes in words.</td> </tr> <tr> <td>[LSB → MSB]</td> <td> <table border="1"> <tr> <td style="text-align: center;">15</td> <td style="text-align: center;">0</td> </tr> <tr> <td style="text-align: center;">MSB</td> <td style="text-align: center;">LSB</td> </tr> <tr> <td style="text-align: center;">2nd byte</td> <td style="text-align: center;">1st byte</td> </tr> </table> </td> </tr> <tr> <td>[MSB → LSB]</td> <td> <table border="1"> <tr> <td style="text-align: center;">15</td> <td style="text-align: center;">0</td> </tr> <tr> <td style="text-align: center;">LSB</td> <td style="text-align: center;">MSB</td> </tr> <tr> <td style="text-align: center;">1st byte</td> <td style="text-align: center;">2nd byte</td> </tr> </table> </td> </tr> </table>	Text Process	Set the order of the first and second bytes in words.	[LSB → MSB]	<table border="1"> <tr> <td style="text-align: center;">15</td> <td style="text-align: center;">0</td> </tr> <tr> <td style="text-align: center;">MSB</td> <td style="text-align: center;">LSB</td> </tr> <tr> <td style="text-align: center;">2nd byte</td> <td style="text-align: center;">1st byte</td> </tr> </table>	15	0	MSB	LSB	2nd byte	1st byte	[MSB → LSB]	<table border="1"> <tr> <td style="text-align: center;">15</td> <td style="text-align: center;">0</td> </tr> <tr> <td style="text-align: center;">LSB</td> <td style="text-align: center;">MSB</td> </tr> <tr> <td style="text-align: center;">1st byte</td> <td style="text-align: center;">2nd byte</td> </tr> </table>	15	0	LSB	MSB	1st byte	2nd byte
Text Process	Set the order of the first and second bytes in words.																		
[LSB → MSB]	<table border="1"> <tr> <td style="text-align: center;">15</td> <td style="text-align: center;">0</td> </tr> <tr> <td style="text-align: center;">MSB</td> <td style="text-align: center;">LSB</td> </tr> <tr> <td style="text-align: center;">2nd byte</td> <td style="text-align: center;">1st byte</td> </tr> </table>	15	0	MSB	LSB	2nd byte	1st byte												
15	0																		
MSB	LSB																		
2nd byte	1st byte																		
[MSB → LSB]	<table border="1"> <tr> <td style="text-align: center;">15</td> <td style="text-align: center;">0</td> </tr> <tr> <td style="text-align: center;">LSB</td> <td style="text-align: center;">MSB</td> </tr> <tr> <td style="text-align: center;">1st byte</td> <td style="text-align: center;">2nd byte</td> </tr> </table>	15	0	LSB	MSB	1st byte	2nd byte												
15	0																		
LSB	MSB																		
1st byte	2nd byte																		

## 5.4.5 Message Display Settings

Each data cell can be selected to display a settings window for the corresponding cell.  
(For details on the editing procedure, refer to the V9 Series Operation Manual.)  
This section explains the case when [Message Display] is selected for [Select Type].

### Select Type

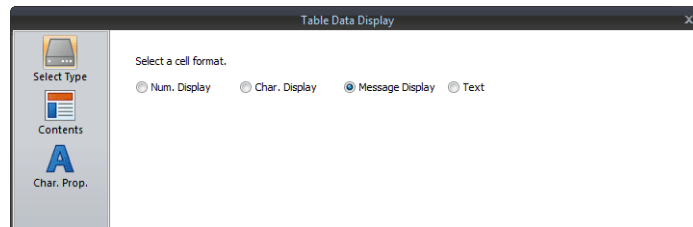

Item	Description
Num. Display Char. Display Message Display Text	Select [Message Display].

### Contents

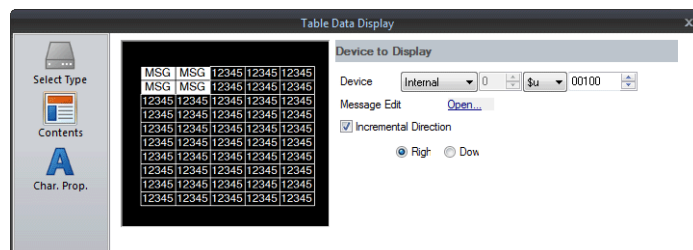

Item	Description
Device	Specify the device memory address to use for message display.
Message Edit	Click [Open] to display the [Message Edit] window. For details on editing messages, refer to the V9 Series Operation Manual.
Incremental Direction	This setting is available when multiple data in the table are selected. For details, refer to <a href="#">page 5-37</a> .

### Char. Prop.

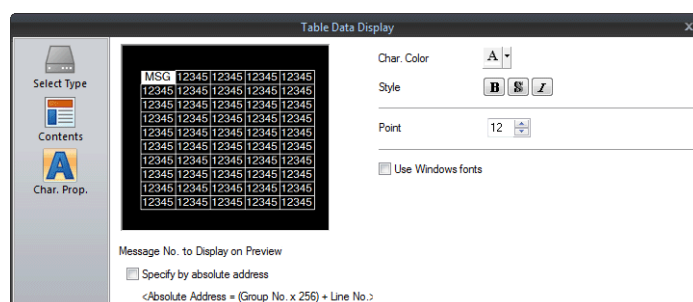

Item	Description
Message No. to Display on Preview	This item is available when the [Display for the editor] checkbox is selected on the [View] → [Display Environment] → [Display] tab. Set the message to display using the editor.
Char. Color	Set the color for text.
Background	Set the background color of text.
Style	Set the text style.
Character Size (1 - 8)	Specify the enlargement factor for text.
Point (6 - 999)	Set the text size.
Use Windows fonts	Select this checkbox to use a Windows font.

## 5.4.6 Text Settings

Each data cell can be selected to display a settings window for the corresponding cell.  
 (For details on the editing procedure, refer to the V9 Series Operation Manual.)  
 This section explains the case when [Text] is selected for [Select Type].

### Select Type

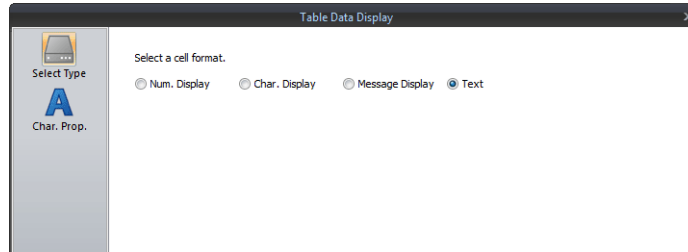

Item	Description
Num. Display Char.Display Message Display Text	Select [Text].

### Char. Prop.

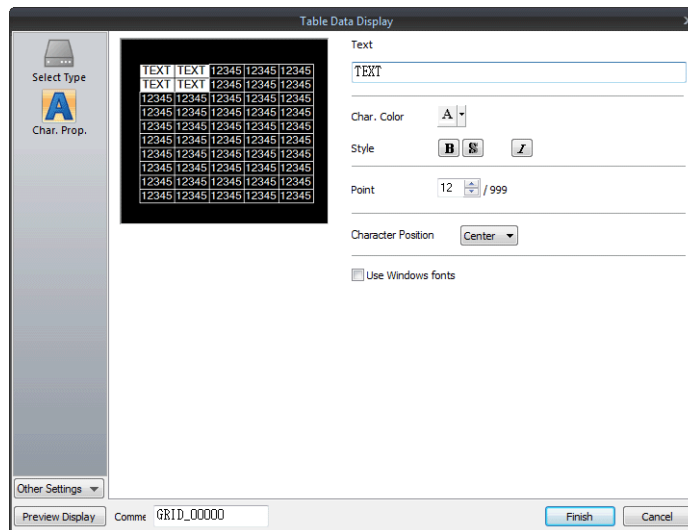

Item	Description			
Text	Enter the text for display.			
Char. Color	Set the color for text.			
Background	Set the background color of text.			
Style	Set the text style.			
Character Size (1 - 8)	Specify the enlargement factor for text.			
Point (6 - 999)	Set the text size.			
Character Position	The character position in the cell can be selected. Flush Left → <table border="1"><tr><td>123</td></tr></table> Center → <table border="1"><tr><td>123</td></tr></table> Flush Right → <table border="1"><tr><td>123</td></tr></table>	123	123	123
123				
123				
123				
Use Windows fonts	Select this checkbox to use a Windows font.			
Smooth Font *1	When "Windows Font" is selected, smooth the edges of text. (Only settable for TrueType Windows fonts.)			

\*1 Cannot be set to transparent.

## 5.5 Notes

### 5.5.1 Placing Switches or Lamps Overlaying Other Switches or Lamps

Take the following points into consideration when placing parts.

#### Placing Numerical Data Displays, Character Displays, and Message Displays

Parts are displayed in the order that they are placed using the editor. This means that switch and lamp parts should be placed in the background and numerical data displays, character displays, and message displays should be placed in the foreground.

#### Placing Table Data (with Switches)

When [Text] is selected for the cell in the first column and first row of the table data, the entire first row is assigned the switch function.

Consequently, any switch part placed on the first row will not be recognized correctly because it is the same as placing a switch on a switch. (In this case, the switch function of the table data has priority.)

Example:

If [Text] is selected for the first column and hidden switch parts are placed on other columns.

No. 1	1004	50	888.9
No. 2	1006	65	100.7
No. 3	999	45	434.0
No. 4	1005	55	123.2
No. 5	1008	41	770.8

Since [Text] is set for the cell in the first column and first row, the hidden switch parts on the first row are invalid.



# MEMO

MONITOUCH

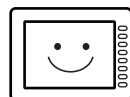

## **6 Entry**

---

6.1 Numerical Data Entry

6.2 Character Input

6.3 Convenient Functions

## 6.1 Numerical Data Entry

### 6.1.1 Overview

Numerical data can be entered using keypads and slider switches and then written to specified device memory addresses. If the target data display is a numerical data display when entering data using a keypad, enter numerical data.

#### Keypad

- Enter numerical data with respect to the entry target using a keypad placed on the screen. The keypad display can be configured to show the value being entered and include allowable input ranges.

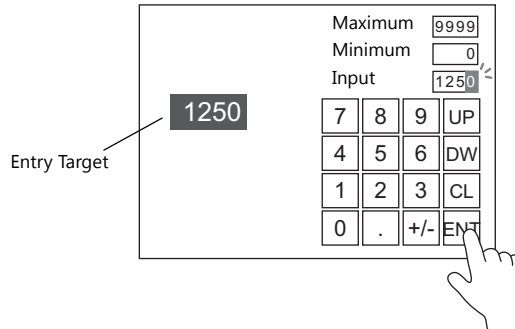

For setting examples, refer to [“Placing an Entry Target and Keypad on the Screen”](#) page 6-2.

For setting examples, refer to [“Specifying an Entry Range”](#) page 6-6.

- A keypad can be displayed when needed and numerical data can be entered with respect to the entry target. The keypad can remain hidden at other times.

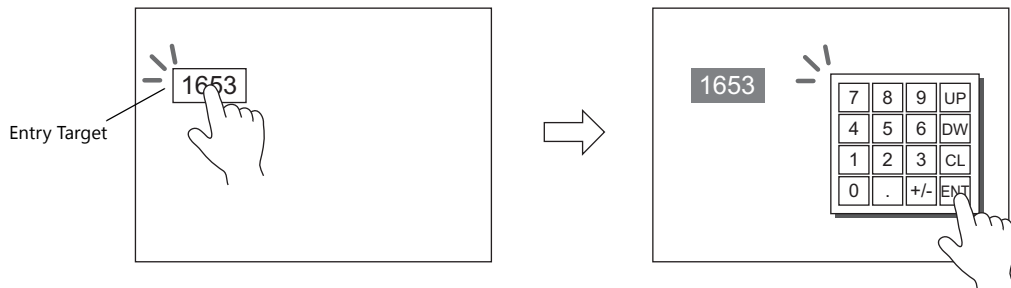

The system keyboard can also be used.

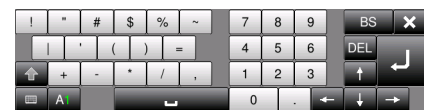

For setting examples, refer to [“Showing the Keypad Only When Necessary”](#) page 6-4.

- Cursor movement can be limited to certain entry targets.

For details, refer to [“6.3.1 Item Select Function”](#) page 6-32.

#### Slider switch

Numerical data can be entered using slider switches.

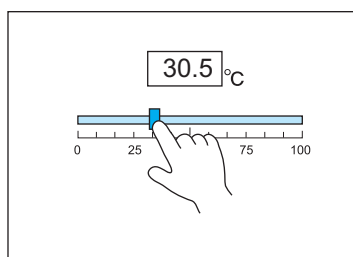

Move the slider switch while holding it down and release it to write the data change.

For setting examples, refer to [“Slider Switch”](#) page 6-7.

## 6.1.2 Setting Examples

### Placing an Entry Target and Keypad on the Screen

There are two methods for placing these parts: placement using an entry target or placement using a keypad. Each procedure is described below using an example.

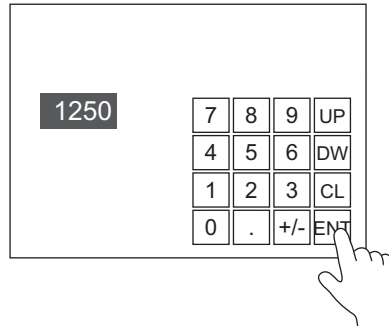

#### Placement Using an Entry Target

1. Click [Parts] → [Data Display ▼] → [Num. Display] and place a numerical data display on the screen.

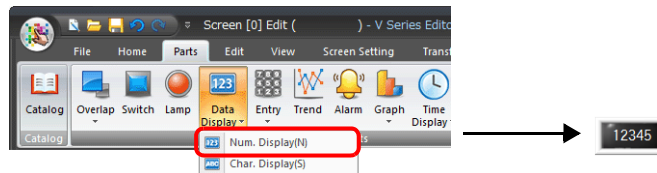

2. Display the settings window for the numerical data display and set the device memory for writing via [Contents] → [Device].

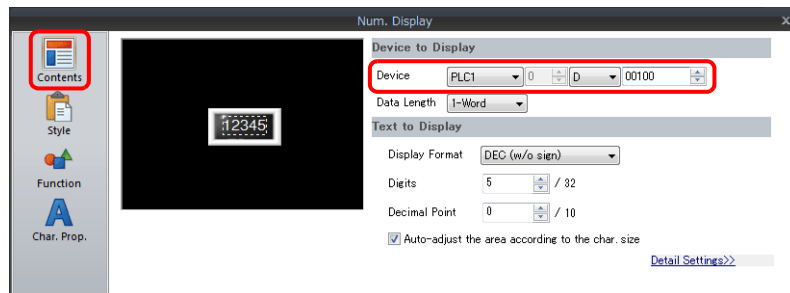

3. Set [Function] to "Entry Target".

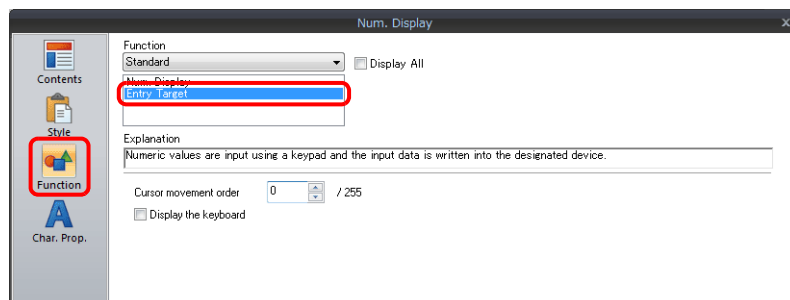

4. Click [Place Keypad] to place a keypad.

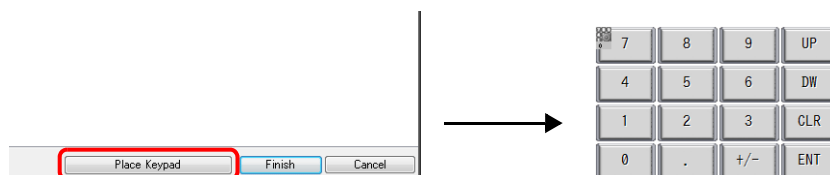

This completes the necessary settings.

## Placement Using a Keypad

1. Click [Parts] → [Entry ▼] → [Keypad] and place a keypad on the screen.

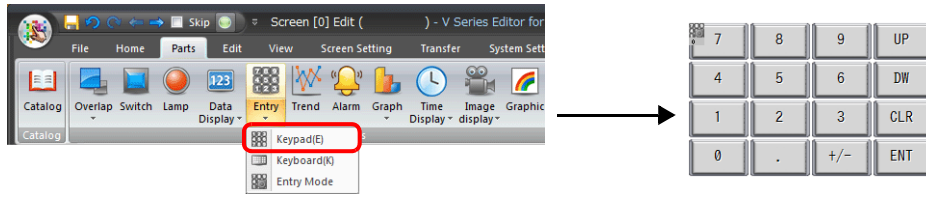

2. Display the settings window for the keypad, click the [Place Entry Target], and place an entry target.

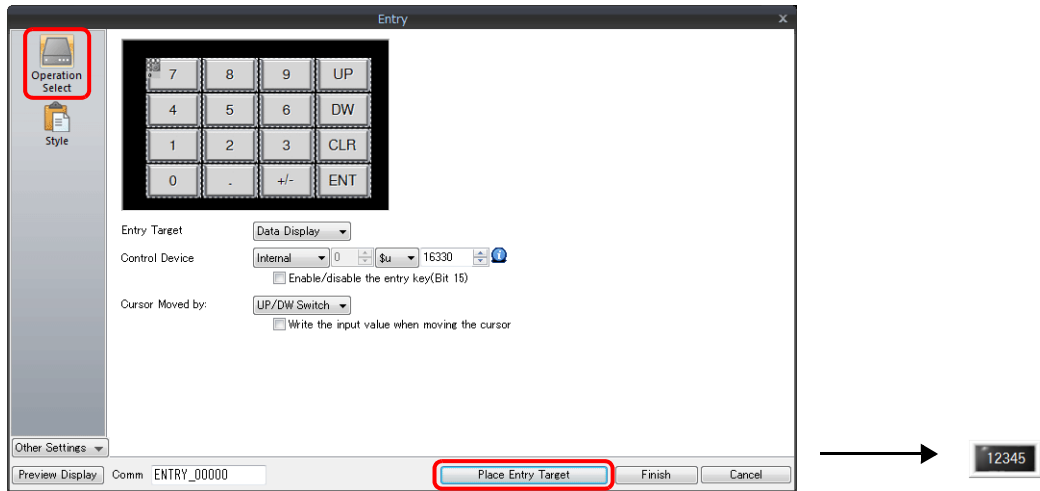

3. Display the settings window for the entry target and set the device memory for writing via [Contents] → [Device].

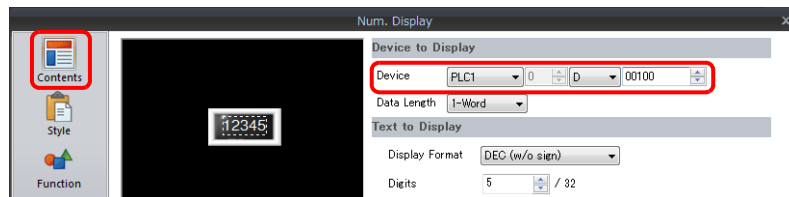

This completes the necessary settings.

\* An entry target can also be placed according to the following procedure.

- 1) Click [Parts] → [Data Display ▼] → [Num. Display] and place a numerical data display on the screen.
- 2) Display the settings window for the numerical data display and set the device memory for writing via [Contents] → [Device].

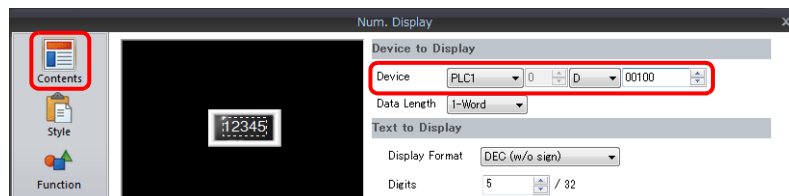

- 3) Set [Function] to "Entry Target".

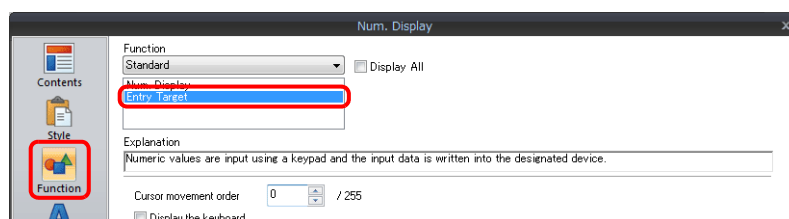

## Showing the Keypad Only When Necessary

This procedure is described below using an example. (The keypad disappears after entry.)

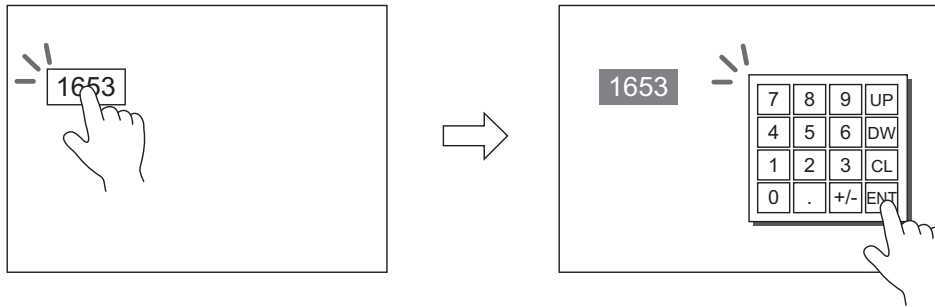

1. Click [Parts] → [Data Display ▼] → [Num. Display] and place a numerical data display on the screen.

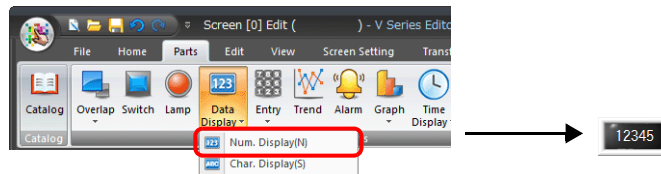

2. Display the settings window for the numerical data display and set the device memory for writing via [Contents] → [Device].

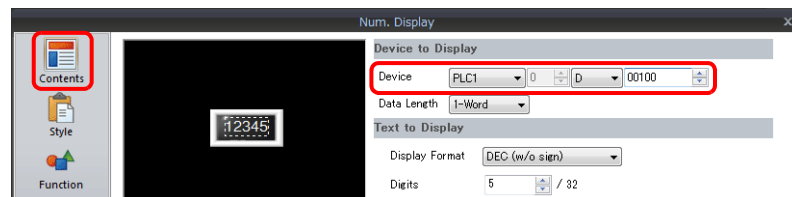

3. Set [Function] to "Entry Target".
4. Select the [Display the keyboard] checkbox and select a keypad.  
When registering a new keypad, click [Register] and select a keypad.

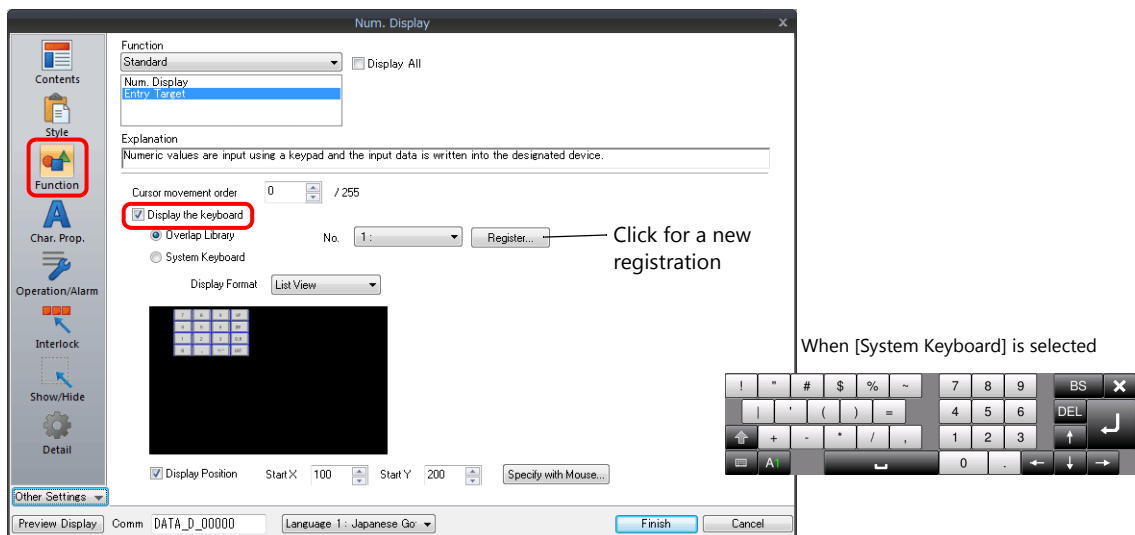

5. Select the [Display Position] checkbox and set the display position of the keypad.  
(The display position cannot be set when the system keyboard is selected.)

This completes the necessary settings.



This setting cannot be performed for table data display entry targets.

## Placing an Entry Display (Value Entry)

This procedure is described below using an example.

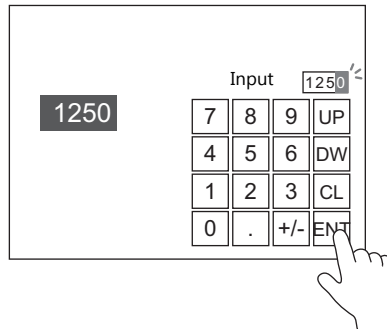

1. Double-click the keypad placed on the screen to display the settings window.
2. Select the [Entry Display Part (Num. Display)] checkbox in [Style] → [Additional Parts List].

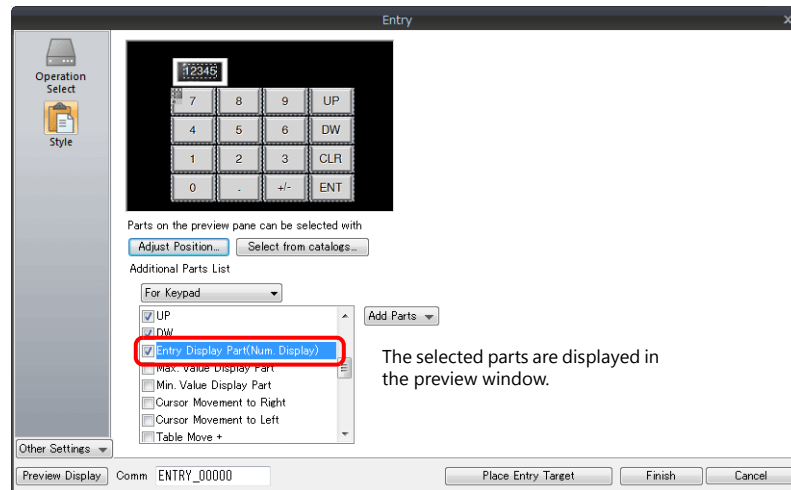

3. Click [Adjust Position] to specify the position of the part.

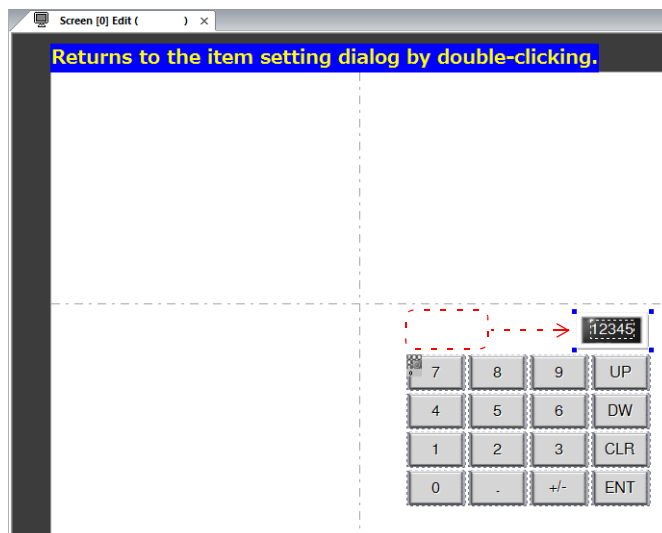

This completes the necessary settings.

## Specifying an Entry Range

This procedure is described below using an example. Example: Entry range: 0 to 9999

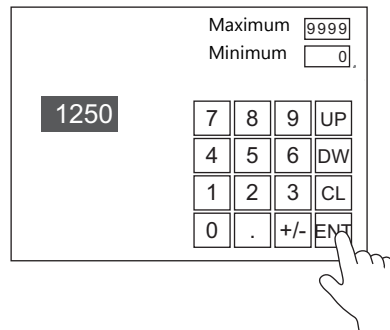

1. Display the numerical data display settings window, click [Operation/Alarm] → [Alarm], and set "0" for the minimum value and "9999" for the maximum value.

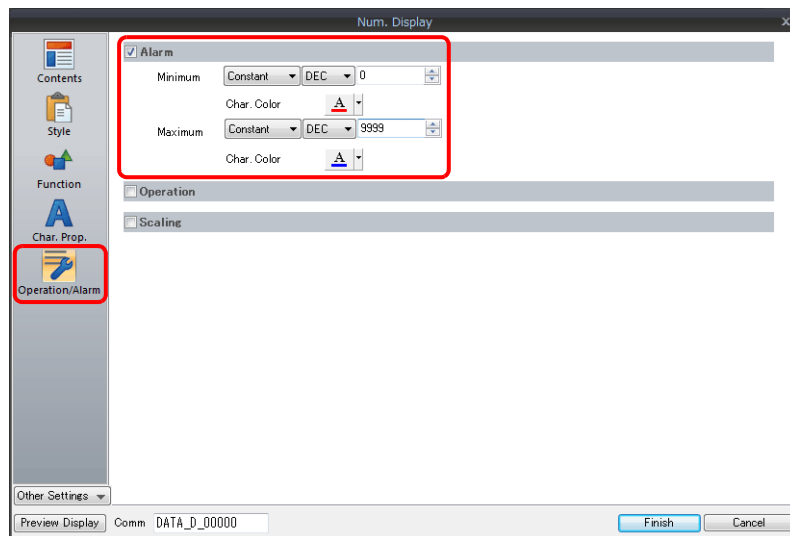

2. Double-click the keypad placed on the screen to display the settings window.
3. Select the [Max. Value Display Part] and [Min. Value Display Part] checkboxes in [Style] → [Additional Parts List].

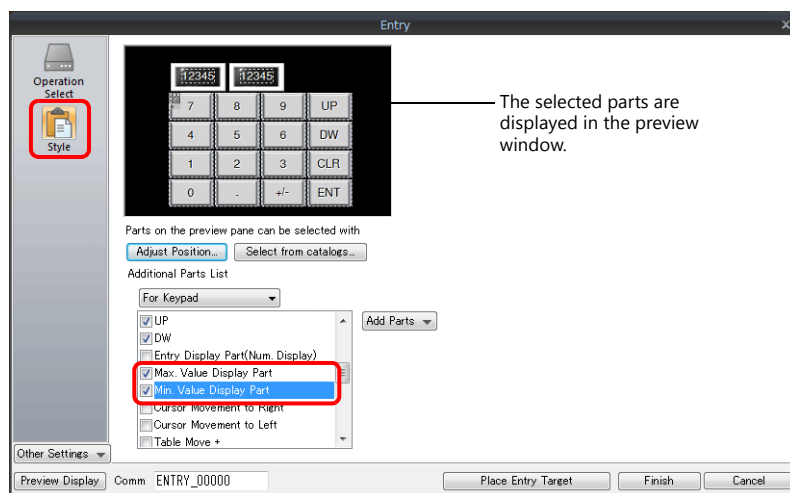

4. Click [Adjust Position] to specify the position of the part.

This completes the necessary settings.



## Slider Switch

This procedure is described below using an example.

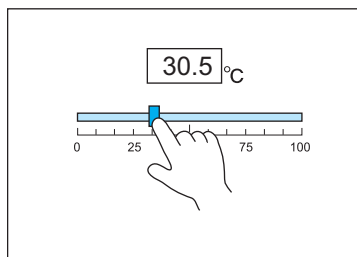

Move the slider switch while holding it down and release it to write the data change.

1. Click [Parts] → [Others] → [Slider Switch] and place a slider switch on the screen.
2. Display the settings window for the slider switch and set the device memory for writing via [Output Setting] → [Device].

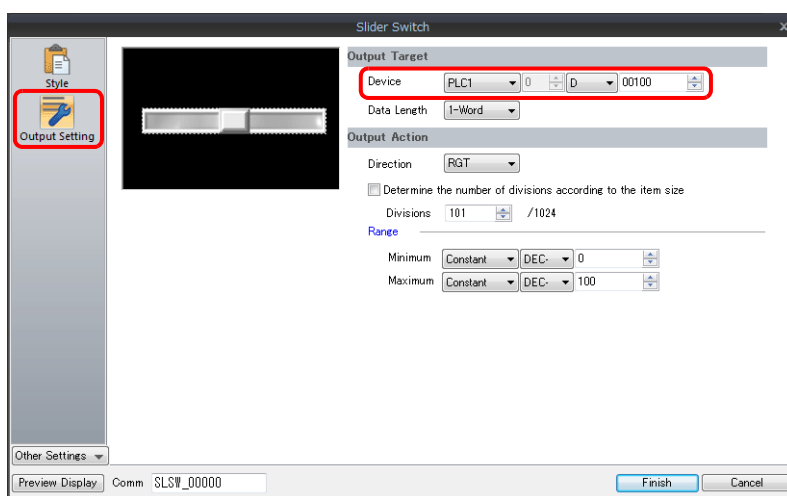

3. Click [Parts] → [Data Display ▼] → [Num. Display] and place a numerical data display on the screen.

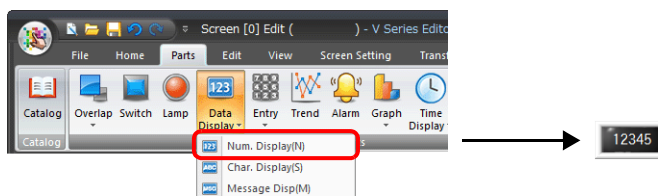

4. Display the settings window for the numerical data display and set the same device memory as in step 2 for [Contents] → [Device].

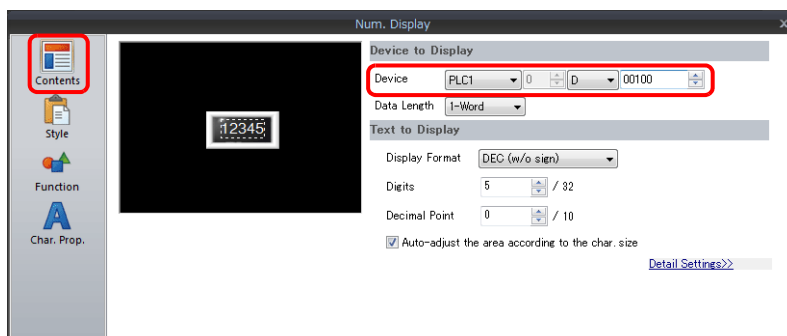

This completes the necessary settings.

## 6.1.3 Detailed Settings

### Keypad

#### Operation Select

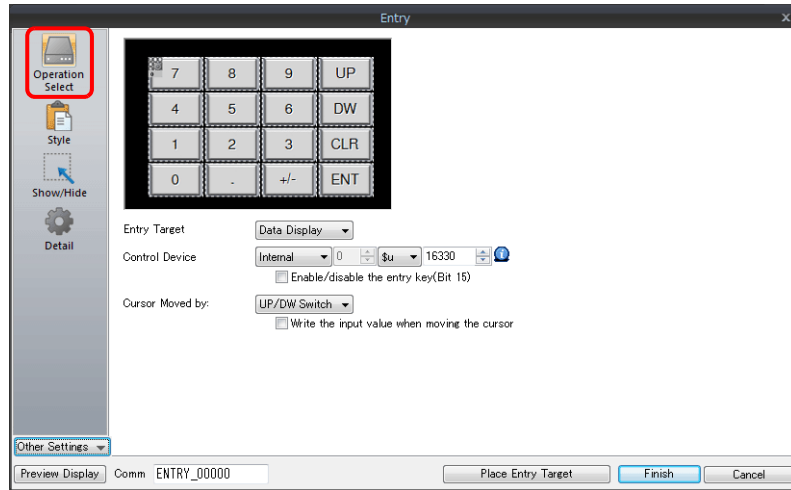

Item	Description
Entry Target	Data Display Enter data with respect to an entry target placed on the screen or an overlap.
Control Device (PLC → V series)	This device memory controls entry. For details, refer to <a href="#">page 6-9</a> .
Enable/disable the entry key (Bit 15)	Select this checkbox to use the 15th bit of the control device memory to prohibit entry key writing. For details, refer to <a href="#">page 6-9</a> .
Cursor Moved by	UP/DW Switch Perform entry target selection and cursor movement using [UP] and [DW] switches.
	Write the input value when moving the cursor Write the entry value to the corresponding device memory when moving the cursor to the next entry target. For details, refer to <a href="#">page 6-8</a> .
	Control Device Perform cursor movement and entry target selection by specifying a cursor movement order number for the control device memory. In this case, the [UP] and [DW] switches cannot be used. For details, refer to <a href="#">page 6-9</a> .

#### Write the input value when moving the cursor

Selecting this option will write the entry value to the corresponding device memory and the cursor is moved to the next entry target using an up or down switch instead of the [ENT] key.

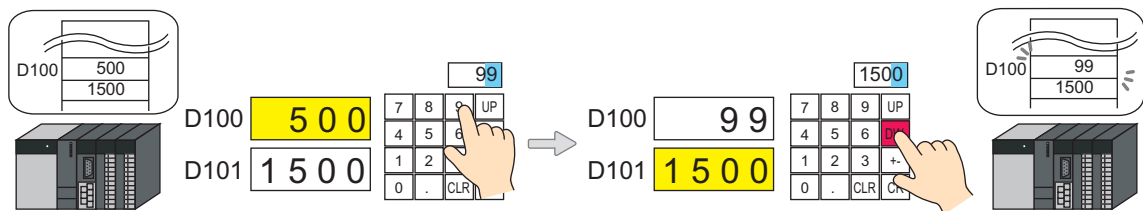

- List of applicable switches

Function	Description	Function	Description
↑	Move the cursor to the previous entry target. (Cursor movement order number - 1)	Table Move +	Move the cursor to the next table data display. (Cursor movement order number + 1)
↓	Move the cursor to the next entry target. (Cursor movement order number + 1)	Table Move -	Move the cursor to the previous table data display. (Cursor movement order number - 1)
Cursor Movement to Right	Move the cursor to the right in the table data display.		
Cursor Movement to Left	Move the cursor to the left in the table data display.		

- Note

When pressing an entry target to call a keypad, the keypad is not hidden after writing is set to occur in conjunction with cursor movement. However, the keypad is hidden after writing completes when the [ENT] key is pressed.

## Control device memory

Control device memory controls entry. Consecutive addresses are used.

The method of control differs depending on the setting of [Operation Select] → [Cursor Moved by].

- [Cursor Moved by]: UP/DW Switch

Device Memory	Description																																																
	<div style="text-align: center;"> <table border="1" style="margin: auto;"> <tr> <td colspan="11">MSB</td> <td colspan="5">LSB</td> </tr> <tr> <td>15</td><td>14</td><td>13</td><td>12</td><td>11</td><td>10</td><td>09</td><td>08</td><td>07</td><td>06</td><td>05</td><td>04</td><td>03</td><td>02</td><td>01</td><td>00</td> </tr> <tr> <td></td><td></td><td></td><td>0</td><td>0</td><td>0</td><td>0</td><td>0</td><td>0</td><td>0</td><td>0</td><td>0</td><td>0</td><td>0</td><td>0</td><td>0</td> </tr> </table> </div> <p style="text-align: center;"> <span style="margin-right: 100px;">Entry area selection</span> <span>Not used (always set to "0")</span>  <span style="margin-right: 100px;">1: Enabled, 0: Disabled</span> </p> <p style="text-align: center;"> <span style="margin-right: 100px;">Cursor movement</span>  <span style="margin-right: 100px;">1: Automatic, 0: Manual</span> </p> <p style="text-align: center;"> <span style="margin-right: 100px;">Write enabled/disabled*</span>  <span style="margin-right: 100px;">1: Enabled, 0: Disabled</span> </p> <p style="text-align: center;">* The [Enable/disable the entry key (Bit 15)] checkbox must be selected.</p>	MSB											LSB					15	14	13	12	11	10	09	08	07	06	05	04	03	02	01	00				0	0	0	0	0	0	0	0	0	0	0	0	0
MSB											LSB																																						
15	14	13	12	11	10	09	08	07	06	05	04	03	02	01	00																																		
			0	0	0	0	0	0	0	0	0	0	0	0	0																																		
n	<p><b>Entry area selection</b> Specify the cursor movement range for the entry target.</p> <p>0: Disabled The cursor moves between areas in the following order:  1) Screen  2) Overlap ID 0  3) Overlap ID 1  :  1: Enabled  Only move the cursor in the single specified range. The range is specified as "control device memory n + 1".</p>																																																
	<p><b>Cursor movement</b> Control cursor movement when the [ENT] key is pressed. This can be used when "UP/DW Switch" is set for [Cursor Moved by].</p> <p>0: Manual The cursor remains in the same position even when the [ENT] key is pressed. Use the [UP] and [DW] switches to move the cursor.  1: Auto Press the [ENT] key to simultaneously write the entry value to the device memory and move the cursor to the next entry target.</p>																																																
	<p><b>Write enabled/disabled</b> This can be used when the [Enable/disable the entry key (Bit 15)] checkbox is selected.</p> <p>0: Disabled Operation of all entry switches is prohibited. If an entry key is pressed, an error beep sounds and no entry is possible. However, cursor movement can be performed with the [UP] and [DW] switches.  1: Enabled Operation of entry switches is allowed.</p>																																																
n+1	<p>The following are used when the value specified for entry area selection is "1" (enabled). Specify the range of cursor movement.</p> <p>0: Screen  1: Overlap ID 0  2: Overlap ID 1  3: Overlap ID 2  4: Overlap ID 3  5: Overlap ID 4  6: Overlap ID 5  7: Overlap ID 6  8: Overlap ID 7  9: Overlap ID 8  10: Overlap ID 9</p>																																																

• [Cursor Moved by]: Control Device

Device Memory	Description																																											
n	<div style="text-align: center;"> <table border="1" style="margin: auto;"> <tr> <td style="text-align: center;">MSB</td> <td style="text-align: center;">15</td><td style="text-align: center;">14</td><td style="text-align: center;">13</td><td style="text-align: center;">12</td><td style="text-align: center;">11</td><td style="text-align: center;">10</td><td style="text-align: center;">09</td><td style="text-align: center;">08</td><td style="text-align: center;">07</td><td style="text-align: center;">06</td><td style="text-align: center;">05</td><td style="text-align: center;">04</td><td style="text-align: center;">03</td><td style="text-align: center;">02</td><td style="text-align: center;">01</td><td style="text-align: center;">00</td> <td style="text-align: center;">LSB</td> </tr> <tr> <td></td> <td style="text-align: center;">0</td><td style="text-align: center;">0</td><td></td><td></td><td style="text-align: center;">0</td><td style="text-align: center;">0</td><td></td><td></td><td></td><td></td><td></td><td></td><td></td><td></td><td></td><td></td><td></td> <td></td> </tr> </table> <p style="text-align: right; margin-right: 100px;">Cursor movement order numbers 0 to 255</p> <p style="text-align: center;">Entry target data selection 0: Data display (numerical display, character display) 1: Table data display part</p> <p style="text-align: left; margin-left: 100px;">Write enabled/disabled* 1: Enabled, 0: Disabled</p> <p style="text-align: center;">* The [Enable/disable the entry key (Bit 15)] checkbox must be selected.</p> </div> <table border="1" style="width: 100%; border-collapse: collapse;"> <tr> <td style="width: 20%; padding: 5px;">Cursor movement order number</td> <td style="padding: 5px;">Specify the cursor movement order number for the data display (numerical display, character display) or table data display entry target. The following bits are used. - For DEC specification: Bits 0 to 7 - For BCD specification: Bits 0 to 9</td> </tr> <tr> <td style="padding: 5px;">Entry target data selection</td> <td style="padding: 5px;">Select the type of data targeted for cursor movement.  0: Data display (numerical display, character display) 1: Table data display part For lines and columns in the table, specify using "control device memory n + 2".</td> </tr> <tr> <td style="padding: 5px;">Write enabled/disabled</td> <td style="padding: 5px;">This can be used when the [Enable/disable the entry key (Bit 15)] checkbox is selected.  0: Disabled Operation of all entry switches is prohibited. If an entry key is pressed, an error beep sounds and no entry is possible. 1: Enabled Operation of entry switches is allowed.</td> </tr> </table>	MSB	15	14	13	12	11	10	09	08	07	06	05	04	03	02	01	00	LSB		0	0			0	0													Cursor movement order number	Specify the cursor movement order number for the data display (numerical display, character display) or table data display entry target. The following bits are used. - For DEC specification: Bits 0 to 7 - For BCD specification: Bits 0 to 9	Entry target data selection	Select the type of data targeted for cursor movement.  0: Data display (numerical display, character display) 1: Table data display part For lines and columns in the table, specify using "control device memory n + 2".	Write enabled/disabled	This can be used when the [Enable/disable the entry key (Bit 15)] checkbox is selected.  0: Disabled Operation of all entry switches is prohibited. If an entry key is pressed, an error beep sounds and no entry is possible. 1: Enabled Operation of entry switches is allowed.
MSB	15	14	13	12	11	10	09	08	07	06	05	04	03	02	01	00	LSB																											
	0	0			0	0																																						
Cursor movement order number	Specify the cursor movement order number for the data display (numerical display, character display) or table data display entry target. The following bits are used. - For DEC specification: Bits 0 to 7 - For BCD specification: Bits 0 to 9																																											
Entry target data selection	Select the type of data targeted for cursor movement.  0: Data display (numerical display, character display) 1: Table data display part For lines and columns in the table, specify using "control device memory n + 2".																																											
Write enabled/disabled	This can be used when the [Enable/disable the entry key (Bit 15)] checkbox is selected.  0: Disabled Operation of all entry switches is prohibited. If an entry key is pressed, an error beep sounds and no entry is possible. 1: Enabled Operation of entry switches is allowed.																																											
n+1	<p>Specify the range of cursor movement.</p> <p>0: Screen 1: Overlap ID 0 2: Overlap ID 1 3: Overlap ID 2 4: Overlap ID 3 5: Overlap ID 4 6: Overlap ID 5 7: Overlap ID 6 8: Overlap ID 7 9: Overlap ID 8 10: Overlap ID 9</p>																																											
n+2	<p>The following are used when the value specified for entry target data selection is "1" (table data display part). Specify the line numbers and column numbers of the table.</p> <div style="text-align: center;"> <table border="1" style="margin: auto;"> <tr> <td style="text-align: center;">MSB</td> <td style="text-align: center;">15</td><td style="text-align: center;">14</td><td style="text-align: center;">13</td><td style="text-align: center;">12</td><td style="text-align: center;">11</td><td style="text-align: center;">10</td><td style="text-align: center;">09</td><td style="text-align: center;">08</td><td style="text-align: center;">07</td><td style="text-align: center;">06</td><td style="text-align: center;">05</td><td style="text-align: center;">04</td><td style="text-align: center;">03</td><td style="text-align: center;">02</td><td style="text-align: center;">01</td><td style="text-align: center;">00</td> <td style="text-align: center;">LSB</td> </tr> <tr> <td></td> <td style="text-align: center;">0</td><td style="text-align: center;">0</td><td></td><td></td><td></td><td></td><td></td><td></td><td style="text-align: center;">0</td><td style="text-align: center;">0</td><td></td><td></td><td></td><td></td><td></td><td></td> <td></td> </tr> </table> <p style="text-align: center; margin-top: 5px;">Column numbers: 1 to 25                      Line numbers: 1 to 20</p> </div>	MSB	15	14	13	12	11	10	09	08	07	06	05	04	03	02	01	00	LSB		0	0							0	0														
MSB	15	14	13	12	11	10	09	08	07	06	05	04	03	02	01	00	LSB																											
	0	0							0	0																																		

## Style

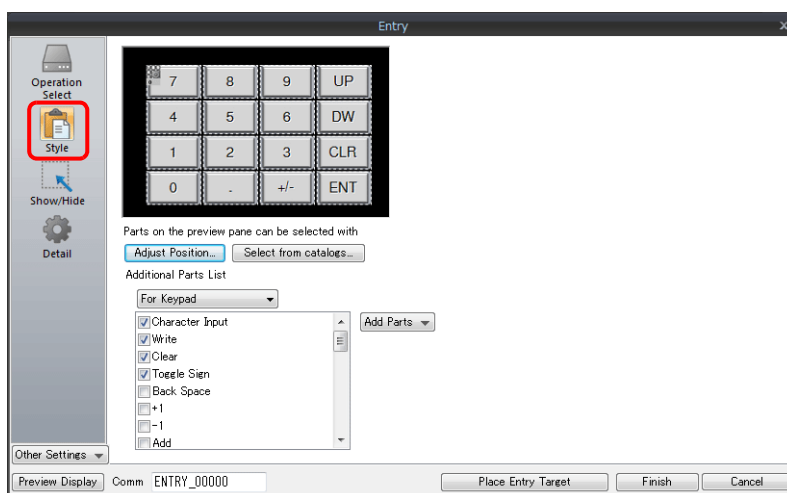

Item	Description
Adjust Position	Change the layout of the keypad and other added parts.
Select from catalogs	Change the keypad part.
Additional Parts List *	Select [For Keypad]. Use this list to add or remove entry-related parts.

\* The following switches can be used on keypads.

Function	Description
Character Input	Enter numerical values or character codes corresponding to the text on the switch.
Write	Transfer the entered data to the specified device memory address. The screen can be changed after the execution of data writing.
Clear	Clear the entered data.
Toggle Sign	Invert the sign of the entered data. The decimal point and sign cannot be deleted.
Back Space <sup>*1</sup>	Delete the character to the left of the cursor.
DELETE <sup>*1</sup>	Delete the character at the current cursor position.
+1	Increment the number at the current cursor position by one.
-1	Decrement the number at the current cursor position by one.
Add	Add the specified constant value. (Data is written when the [ENT] key is pressed.)
Subtraction	Subtract the specified constant value. (Data is written when the [ENT] key is pressed.)
Cancel	Restore the initially displayed value (the value prior to entry) during an entry operation.
LFT <sup>*1</sup>	Move the cursor left.
RGT <sup>*1</sup>	Move the cursor right.
UP <sup>*2</sup>	Move the cursor to the previous entry target. (Cursor movement order number -1)
DW <sup>*2</sup>	Move the cursor to the next entry target. (Cursor movement order number + 1)
Entry Display Part (Num. Display)	Temporarily display the entered value.
Max. Value Display Part	Display the maximum value set for the entry target.
Min. Value Display Part	Display the minimum value set for the entry target.
Cursor Movement to Right <sup>*2</sup>	Move the cursor to the right in the table data display.
Cursor Movement to Left <sup>*2</sup>	Move the cursor to the left in the table data display.
Table Move + <sup>*2</sup>	Move the cursor to the next table data display. (Cursor movement order number + 1)
Table Move - <sup>*2</sup>	Move the cursor to the previous table data display. (Cursor movement order number - 1)
Max. Value Entry	Press this switch for an entry target with an alarm setting to display the maximum value on the entry display. Pressing the [ENT] key will write the maximum value to the entry target.
Min. Value Entry	Press this switch for an entry target with an alarm setting to display the minimum value on the entry display. Pressing the [ENT] key will write the minimum value to the entry target.

- \*1 This setting is available when the [Allow to use Insert/DELETE keys when entering values] checkbox is selected in [System Setting] → [Unit Setting] → [General Setting].  
This allows insertion by moving the cursor with the [LFT] and [RGT] function switches and deletion using the delete and backspace switches. This setting is enabled for keypads on all screens. However, take the following points into consideration.

- During entry operations, entered values are displayed in flush-right format with zero suppression regardless of the display format of the numerical data display. The display returns to the specified display format after value entry is complete.

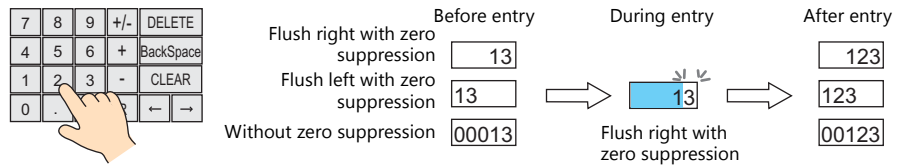

- Insertion at the whole number part  
Values are inserted to the right of the cursor. When values exist at all places, entering a new value deletes the most significant digit. Additionally, entering a value at the most significant digit of the whole number part overwrites the current value.
- Insertion at the fractional part  
Values are inserted to the left of the cursor. When values exist at all places, entering a new value deletes the least significant digit of the fractional part. Additionally, entering a value at the least significant digit of the fractional part overwrites the current value.

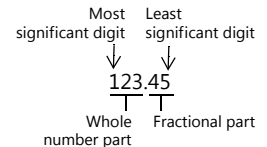

\*2 Cursor movement for table data display parts

- If there are multiple entry targets in a table data display part, move the cursor using the [DW] and [UP] function switches or [Cursor Movement to Right] and [Cursor Movement to Left] function switches.

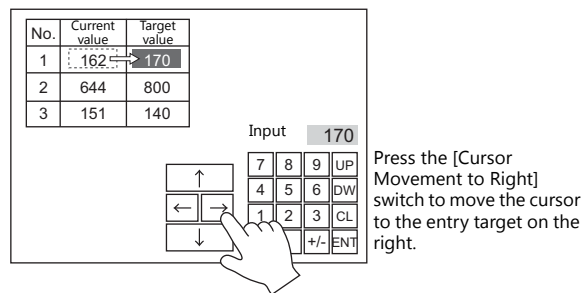

- If there are multiple table data entry targets, move the cursor between the table data display parts using the [Table Move +] and [Table Move -] function switches.

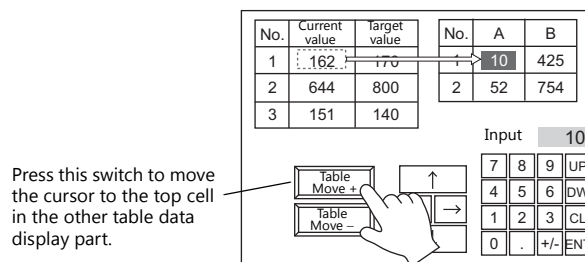

- Special functions

Setting the cell on the first line of the first column ("No." in the example below) of a table data display part that has entry targets to a text value will add switch functionality to the first line. When the first line is pressed, the cursor moves to the first entry target cell in the table data display part. (This works in the same way as the [Table Move +] and [Table Move -] function switches.)

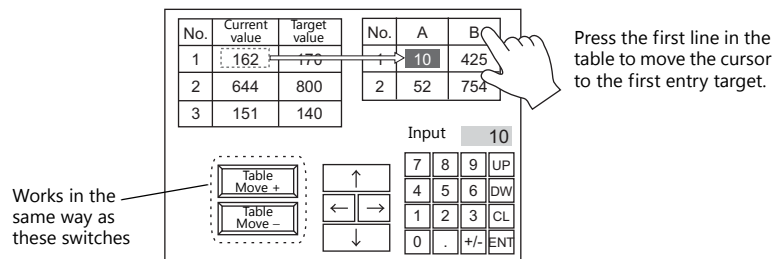

This function is enabled when [Operation Select] → [Entry Target] is set to "Data Display" for the keypad.

## Detail

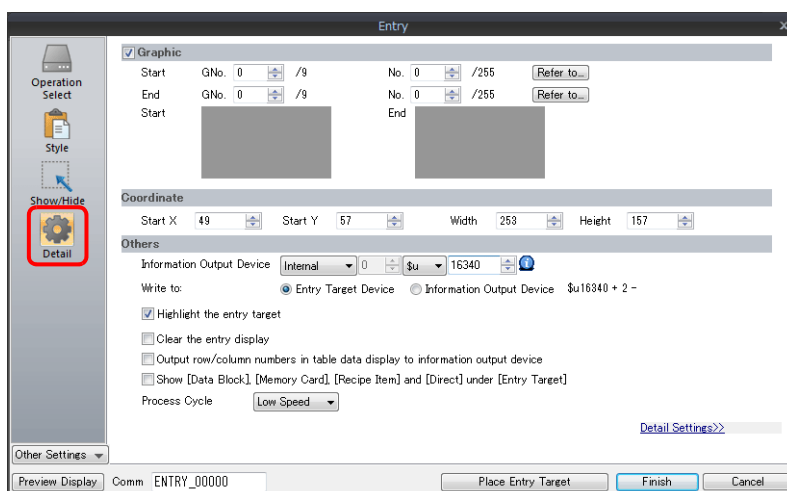

Item	Description
Graphic	The text placed on the graphic library can be regarded as entry text. Change between multiple graphic libraries using a switch that has [Function] set to "Graphic Library".
Coordinates	Set the placement position of the keypad.
Others	Information Output Device (V series → PLC)
	This is the device memory that stores the entry state. Processing differs depending on the setting of [Detail] → [Output row/column numbers in table data display to information output device]. For details, refer to <a href="#">page 6-14</a> .
	Write to
	Entry Target Device. Data from the entry target is written to the specified device memory address. Information Output Device For numerical data entry → n+2, n+3 For text entry → n+2 onwards (number of bytes ÷ 2 = number of words used) - Example: Text Entering one-byte 10 characters into PLC device memory starting at D100: 10 ÷ 2 = 5 words D100 to D104 of the PLC device memory are used.
	Highlight the entry target
	Highlight the display of the entry target selected with the cursor.
	Clear the entry display
	Clear the data value on the entry display each time the [ENT] key is pressed.
	Output row/column numbers in table data display to information output device
	This setting is available when the entry target is a table data display part. Select this checkbox to store line and column numbers of table data in the device memory specified for [Information Output Device] n + 1. For details, refer to <a href="#">page 6-14</a> .
	Show [Data Block], [Memory Card], [Recipe Item] and [Direct] under [Entry Target]
	The number of types listed for [Operation Select] → [Entry Target] increases.  Data Block Use when entering data into a data block area. Memory Card Use on a keypad to perform name editing in memory card mode. Recipe Item Use on a keypad to perform name editing in recipe mode. Direct Use when controlling all processing up to the data write operation using external commands.
Process Cycle	Set a cycle for the V series to read the PLC data while it is communicating with the PLC. For details, refer to <a href="#">"1.2 Process Cycle"</a> .
ID	Set the ID. For details on IDs, refer to the V9 Series Operation Manual.

### Information output device memory

This is the device memory that stores the entry mode state. Consecutive addresses are used. Processing differs depending on the setting of [Detail] → [Output row/column numbers in table data display to information output device].

- [Output row/column numbers in table data display to information output device]: Unselected

Device Memory	Description																																
	<div style="text-align: center;"> </div> <p>MSB <span style="float: right;">LSB</span></p> <table border="1" style="margin-left: auto; margin-right: auto;"> <tr> <td>15</td><td>14</td><td>13</td><td>12</td><td>11</td><td>10</td><td>09</td><td>08</td><td>07</td><td>06</td><td>05</td><td>04</td><td>03</td><td>02</td><td>01</td><td>00</td> </tr> <tr> <td></td><td></td><td>0</td><td>0</td><td>0</td><td>0</td><td></td><td></td><td></td><td></td><td></td><td></td><td></td><td></td><td></td><td></td> </tr> </table> <p>Entry operation 1: Enabled, 0: Disabled</p> <p>Cursor movement order numbers 0 to 255</p> <p>Write status 1: Completed, 0: Not written</p>	15	14	13	12	11	10	09	08	07	06	05	04	03	02	01	00			0	0	0	0										
15	14	13	12	11	10	09	08	07	06	05	04	03	02	01	00																		
		0	0	0	0																												
n	<p><b>Cursor movement order number</b></p> <p>The cursor movement order number of the currently selected entry target is stored. The following bits are used.</p> <ul style="list-style-type: none"> <li>- For DEC specification: Bits 0 to 7</li> <li>- For BCD specification: Bits 0 to 9</li> </ul>																																
	<p><b>Entry operation</b></p> <p>If multiple keypad parts are displayed, the bit of the keypad in the foreground is set to "1" and the keypad becomes available for entry. If only one keypad is displayed, it is always set to "1".</p>																																
	<p><b>Write status</b></p> <p>This bit shows whether the [ENT] key has been pressed or not.</p> <p>0: Not written Indicates that the [ENT] key has not been pressed.</p> <p>1: Completed Indicates that the [ENT] key was pressed and data was written to the device memory. Unless the cursor moves to another entry target, this bit remains set to "1". It is recommended to clear this bit to "0" after confirmation.</p>																																
n+1	<p>The currently selected cursor movement range is stored.</p> <p>0: Screen 1: Overlap ID 0 2: Overlap ID 1 3: Overlap ID 2 4: Overlap ID 3 5: Overlap ID 4 6: Overlap ID 5 7: Overlap ID 6 8: Overlap ID 7 9: Overlap ID 8 10: Overlap ID 9</p>																																
n+2	<p>When [Operation Select] → [Entry Target] is set to "Data Block", the currently displayed data block number is stored. No. 0 - 1023</p>																																
n+3 - n+m	<p>When [Detail] → [Write to] is set to "Information Output Device", the entered value is stored.</p> <p>Numerical value: 2 words maximum Text: Number of bytes ÷ 2 words (if the number of bytes is odd, 1 byte is added.)</p>																																

- [Output row/column numbers in table data display to information output device]: Selected

Device Memory	Description																																
n	This is the same as "[Output row/column numbers in table data display to information output device]: Unselected" page 6-14.																																
n+1																																	
n+2	<p>The line and column numbers of the selected table data cell are stored.</p> <div style="text-align: center;"> </div> <p>MSB <span style="float: right;">LSB</span></p> <table border="1" style="margin-left: auto; margin-right: auto;"> <tr> <td>15</td><td>14</td><td>13</td><td>12</td><td>11</td><td>10</td><td>09</td><td>08</td><td>07</td><td>06</td><td>05</td><td>04</td><td>03</td><td>02</td><td>01</td><td>00</td> </tr> <tr> <td>0</td><td>0</td><td></td><td></td><td></td><td></td><td></td><td></td><td>0</td><td>0</td><td></td><td></td><td></td><td></td><td></td><td></td> </tr> </table> <p>Column selection (1 to 25) <span style="margin-left: 100px;">Line selection (1 to 20)</span></p>	15	14	13	12	11	10	09	08	07	06	05	04	03	02	01	00	0	0							0	0						
15	14	13	12	11	10	09	08	07	06	05	04	03	02	01	00																		
0	0							0	0																								
n+3	<p>When [Operation Select] → [Entry Target] is set to "Data Block", the currently displayed data block number is stored. No. 0 - 1023</p>																																
n+4 - n+m	<p>When [Detail] → [Write to] is set to "Information Output Device", the entered value is stored.</p> <p>Numerical value: 2 words maximum Text: Number of bytes ÷ 2 words (if the number of bytes is odd, 1 byte is added.)</p>																																



## Entry Target

This section only explains the essential entry settings.

## Numerical Data Display

### Contents

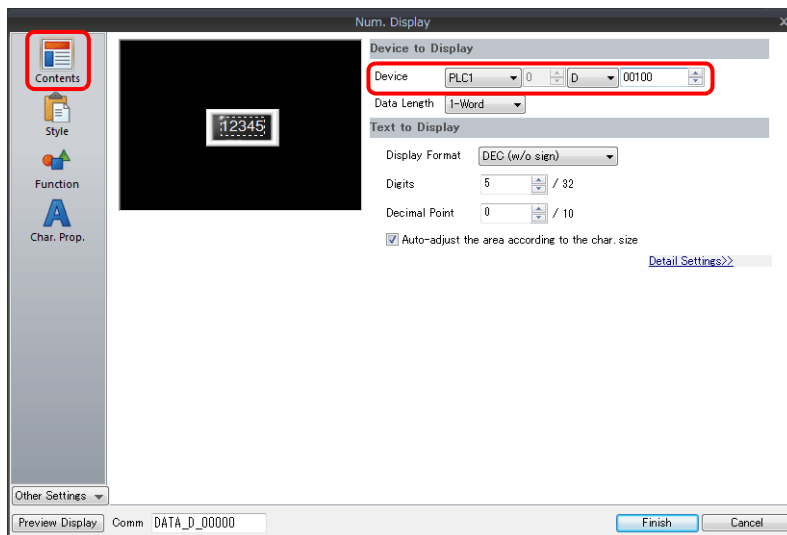

Item	Description
Device	Set the device memory for writing.

### Function

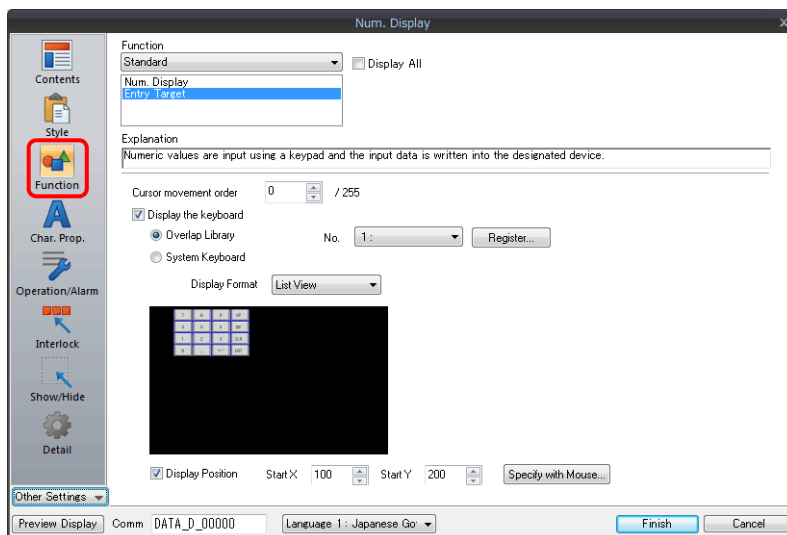

Item	Description
Function	Set the entry target.
Cursor movement order	Set the cursor movement order. The cursor can be moved with the [UP] and [DW] switches or using a control device memory.
Display the keyboard	Select a keypad. Click [Register] when registering a new keypad part.
Display Format	Change the list view of the overlap library.
Display Position	Unselected: Display using the position of the keypad registered in the overlap library. Selected: Specify the keypad display position. The display coordinates can be set with the mouse by clicking [Specify with Mouse].

## Operation/Alarm

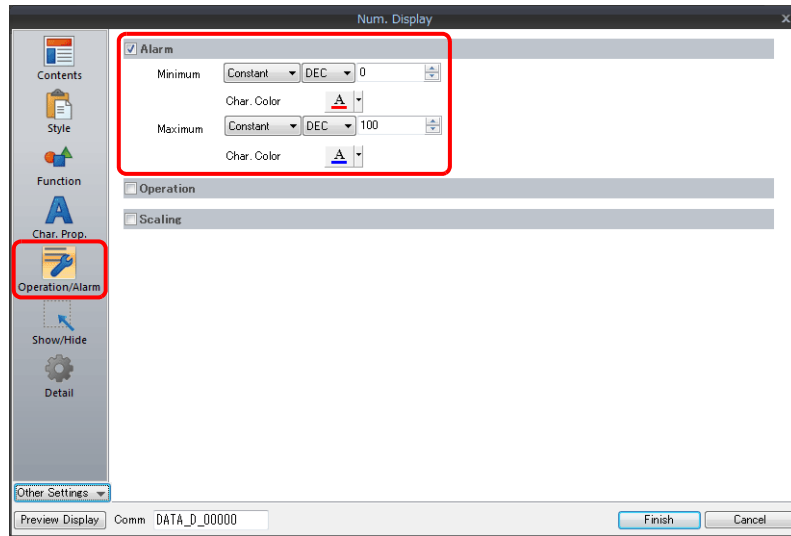

Item	Description
Alarm	Set the entry range. Data can be entered within the range of the minimum and maximum values. If data that exceeds the specified range is entered using an external command (other than a keypad), the entry target is displayed in the specified color.

## Interlock

This is used to control the calling of keypads.

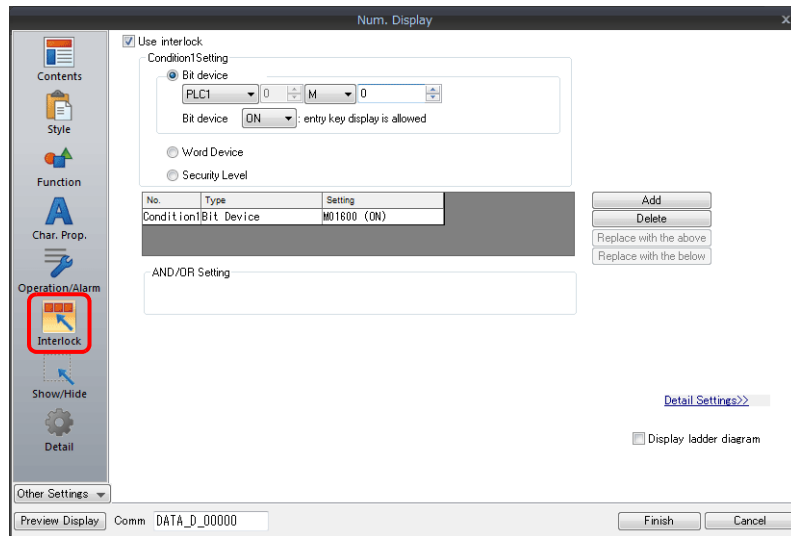

 For details, refer to [page 3-14](#).

## Table Data Display

### General settings

Location of settings: Double-click on the table data display

- Detail

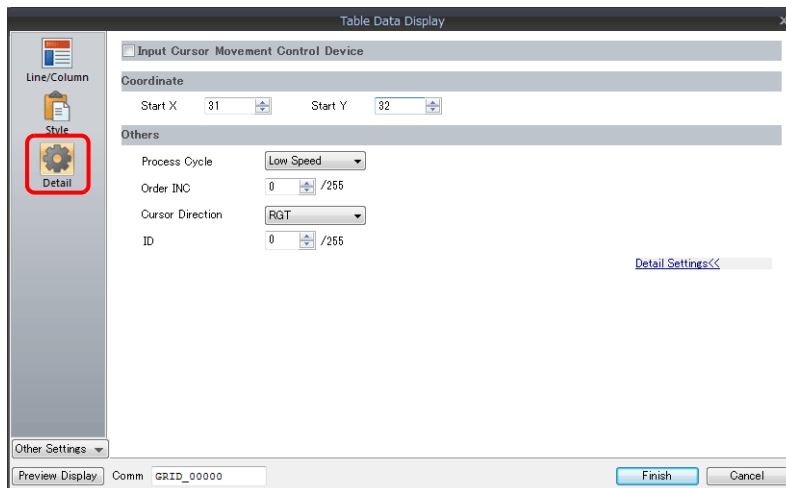

Item	Description
Input Cursor Movement Control Device	Perform cursor movement control. For details, refer to <a href="#">“6.3.1 Item Select Function”</a> page 6-32.
Order INC	When the table data display contains multiple table data display parts for which [Function] is set to “Entry Target”, this determines the order of precedence of each table data display part.
Cursor Direction	Select the direction in which the cursor moves when the [ENT] key is pressed. This setting is available when [Operation Select] → [Cursor Moved by] is set to “UP/DW Switch” for the keypad and bit 14 (cursor movement) of [Control Device] is set to ON.
ID	Set an ID number.

### Table cells

Location of settings: Right-click on table cell → right-click menu → [Detail Setting]

- Select Type

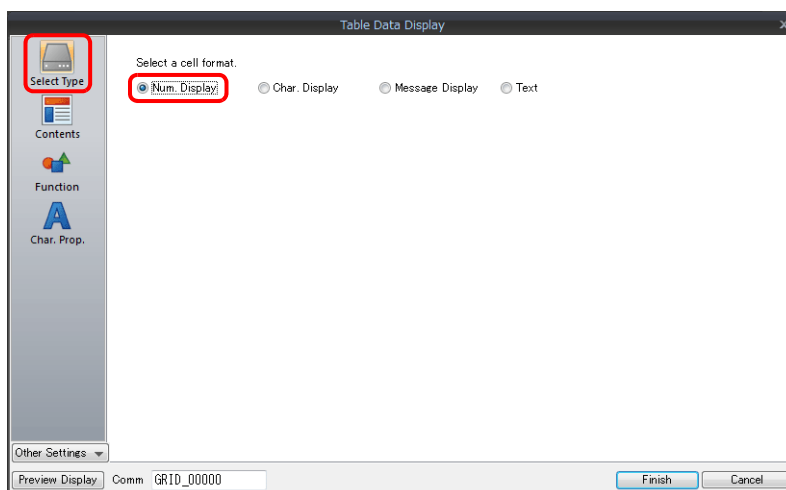

Item	Description
Select Type	Set the display format to [Num. Display].

- Contents

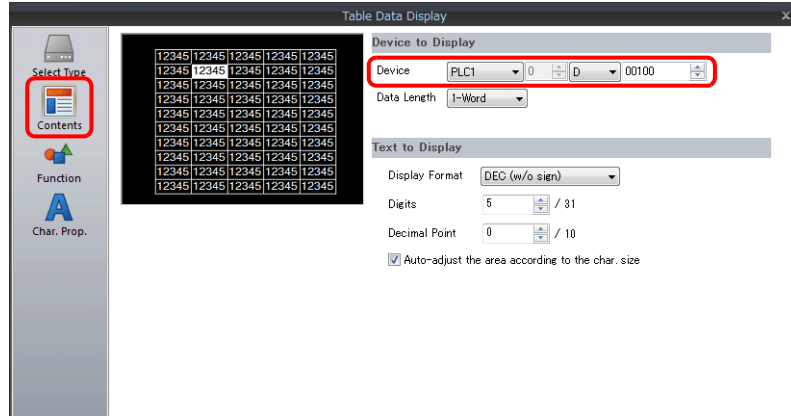

Item	Description
Device	Set the device memory for writing.

- Function

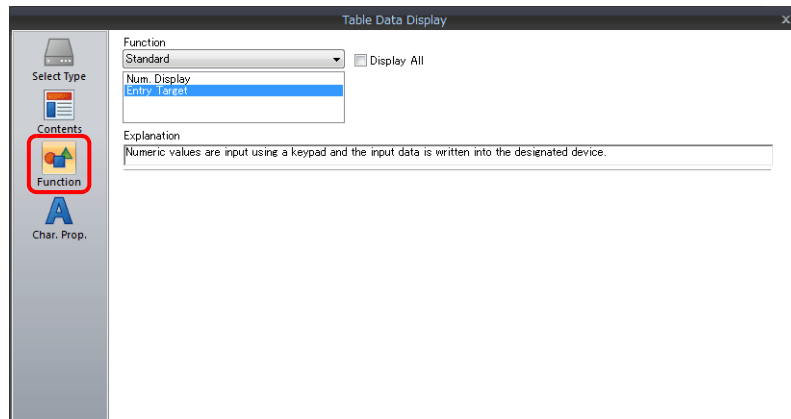

Item	Description
Function	Set the entry target.

- Operation/Alarm

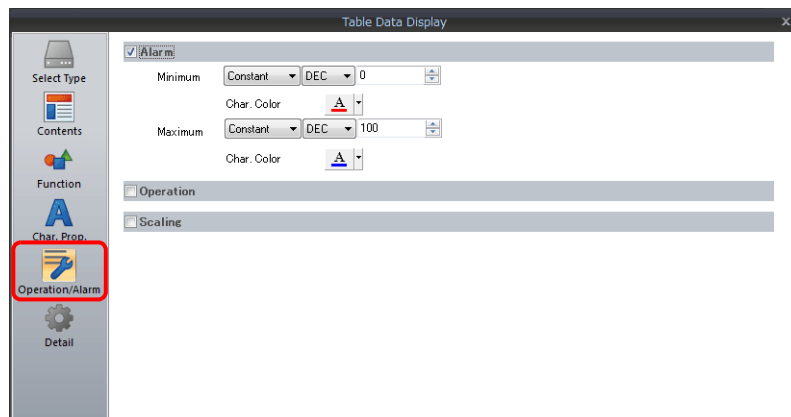

Item	Description
Alarm	Set the entry range. Data can be entered within the range of the minimum and maximum values. If data that exceeds the specified range is entered using an external command (other than a keypad), the entry target is displayed in the specified color.

# Slider Switch

## Style

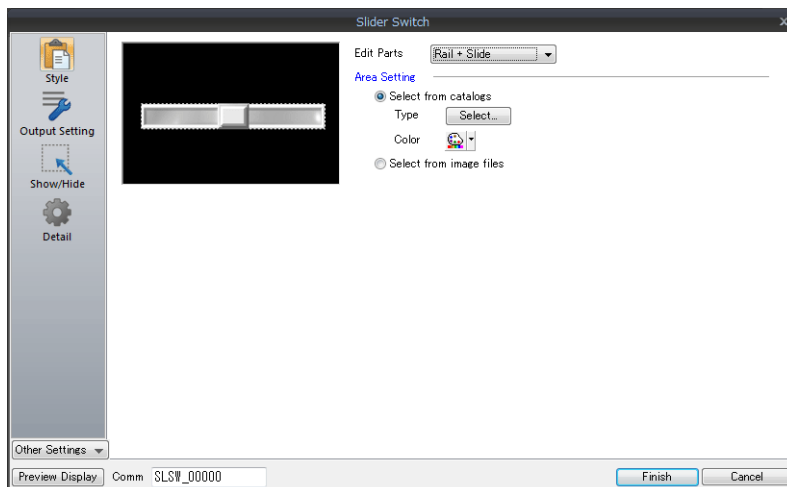

Item	Description
Area Setting	Set the part design.

## Output Setting

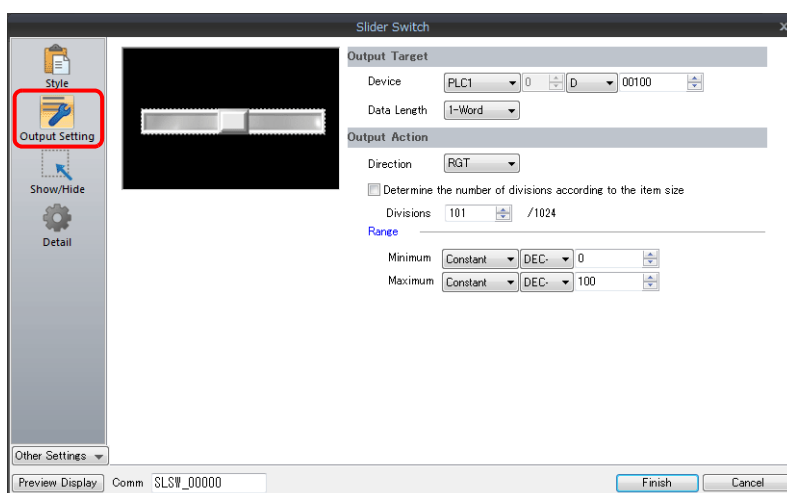

Item	Description
Device	Set the device memory for writing data.
Data Length	Set data length for the device memory. (1-Word/2-Word)
Direction	Set the sliding direction.
Determine the number of divisions according to the item size	Select this checkbox to automatically define the number of divisions for the rail according to the size and scale value of the rail.
Divisions	Set the number of rail divisions. (2 to 1024) * If the rail size is smaller than the number of divisions, the rail is divided by the set number in the same manner as when the [Determine the number of divisions according to the item size] checkbox is selected.
Range	Set the writable range of the slider switch. This range can be changed by switching to device memory specification.

## 6.2 Character Input

### 6.2.1 Overview

A keyboard (or USB keyboard) or barcode reader can be used to enter text data (ASCII code data) to be written to the specified device memory address.  
 If the target data display is a character display when entering data using a keyboard, enter text data.

#### Keyboard

- Enter characters with respect to the entry target using a keyboard placed on the screen.

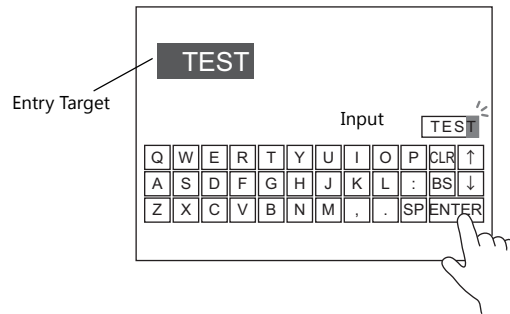

For setting examples, refer to [“Placing an Entry Target and Keyboard on the Screen”](#) page 6-22.

- A keyboard can be displayed when needed and character data can be entered with respect to the entry target. The keyboard can remain hidden at other times.

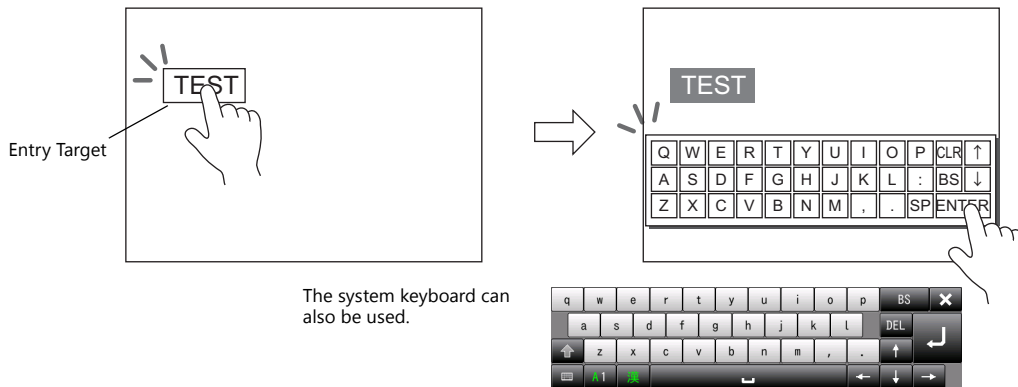

For setting examples, refer to [“Showing the Keyboard Only When Necessary”](#) page 6-24.

- Cursor movement can be limited to certain entry targets.

For details, refer to [“6.3.1 Item Select Function”](#) page 6-32.

#### USB keyboard

- Text can be entered with respect to the entry target using a USB keyboard connected to the USB-A port.

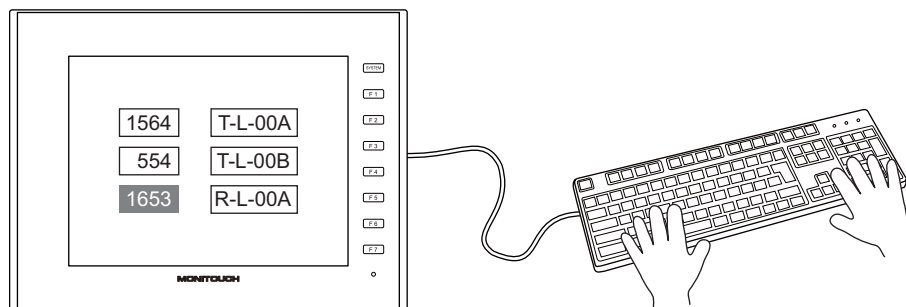

- \* Supported keyboards
- Japanese keyboard (106 keyboard, 109 keyboard, etc.)
  - US keyboard (101 keyboard, 104 keyboard, etc.)
  - Keypad

For setting examples, refer to [“USB Keyboard Entry”](#) page 6-25.

## Password

A password entry screen can be created using a character display.

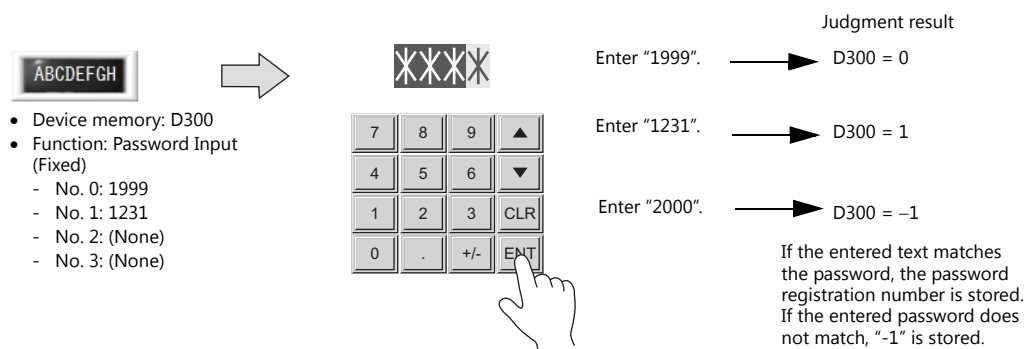

For details on the setting method, refer to ["Password Input"](#) page 6-26.

## Barcode reader

The V9 series reads barcode data, converts the necessary data into ASCII code, and stores results in the specified PLC device memory address. This allows various types of information to be transferred immediately using barcodes.

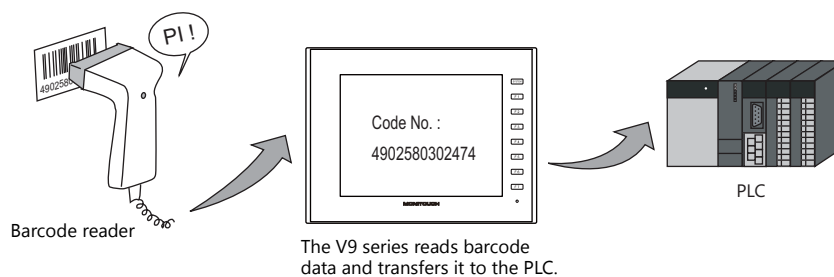

For details, refer to ["17 Barcode"](#).

## 6.2.2 Setting Examples

### Placing an Entry Target and Keyboard on the Screen

There are two methods for placing these parts: placement using an entry target or placement using a keyboard. Each procedure is described below using an example.

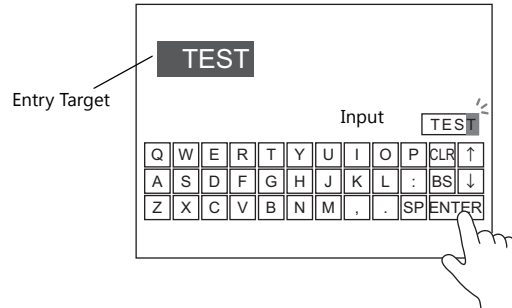

#### Placement Using an Entry Target

1. Click [Parts] → [Data Display ▼] → [Char. Display] and place a character display on the screen.

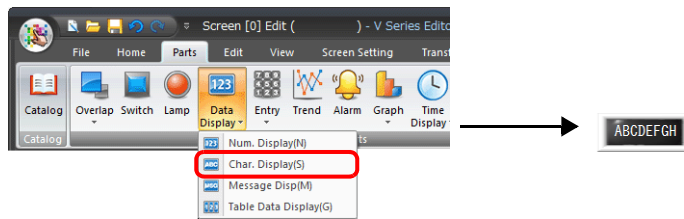

2. Display the settings window for the character display and set the [Contents] → [Device] and [No. of Bytes] settings.

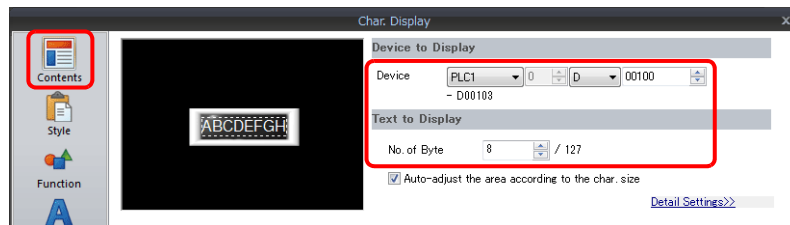

3. Set [Function] to "Entry Target".

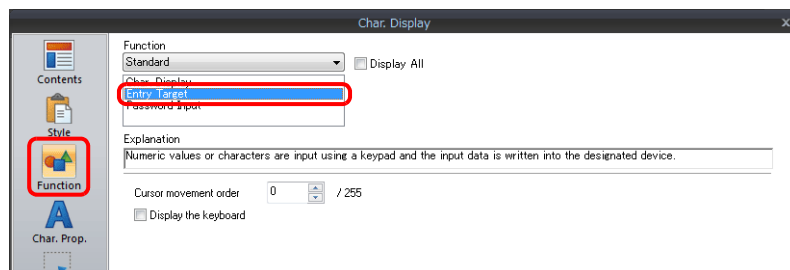

4. Click [Place Keyboard] to place a keyboard.



This completes the necessary settings.



## Placement Using a Keyboard

1. Click [Parts] → [Entry ▼] → [Keyboard] and place a keyboard on the screen.

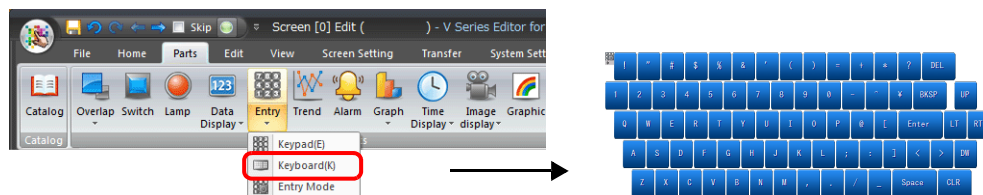

2. Display the settings window for the keyboard, click the [Place Entry Target], and place an entry target.

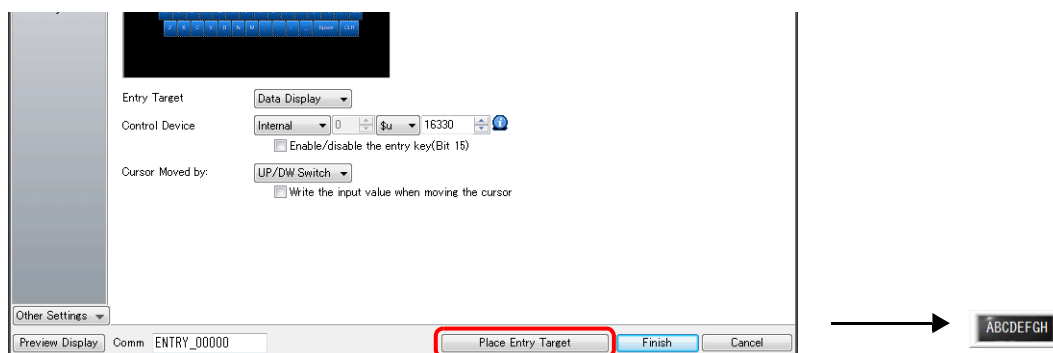

3. Display the settings window for the entry target (character display) and set the [Contents] → [Device] and [No. of Bytes] settings.

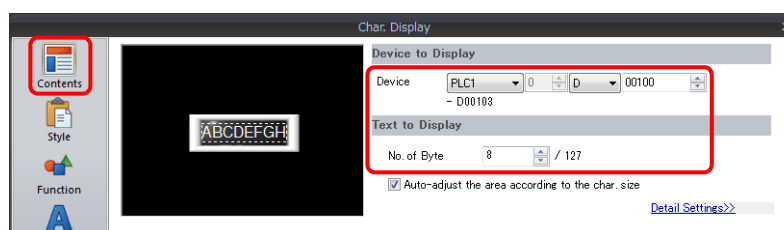

This completes the necessary settings.

\* An entry target can also be placed according to the following procedure.

- 1) Click [Parts] → [Data Display ▼] → [Char. Display] and place a character display on the screen.
- 2) Display the settings window for the character display and set the device memory for writing via [Contents] → [Device].

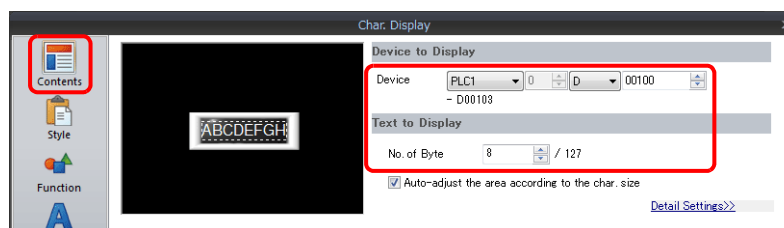

- 3) Set [Function] to "Entry Target".

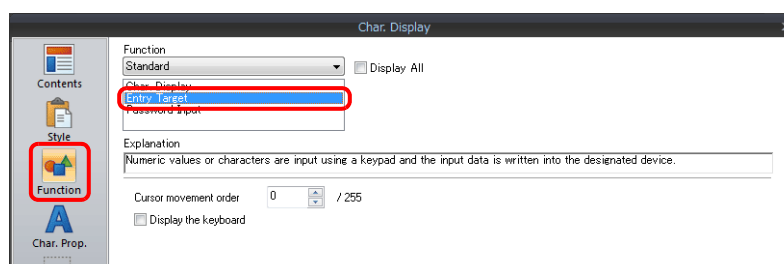

## Showing the Keyboard Only When Necessary

This procedure is described below using an example. (The keyboard disappears after entry.)

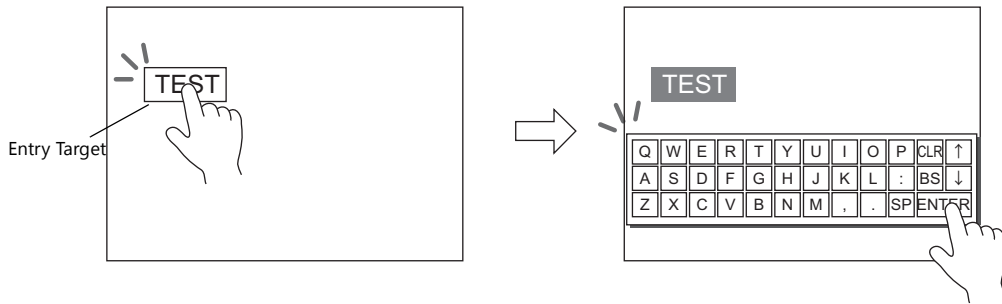

1. Click [Parts] → [Data Display ▼] → [Char. Display] and place a character display on the screen.

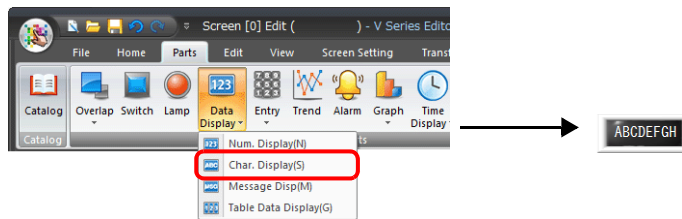

2. Display the settings window for the character display and set the device memory for writing via [Contents] → [Device].

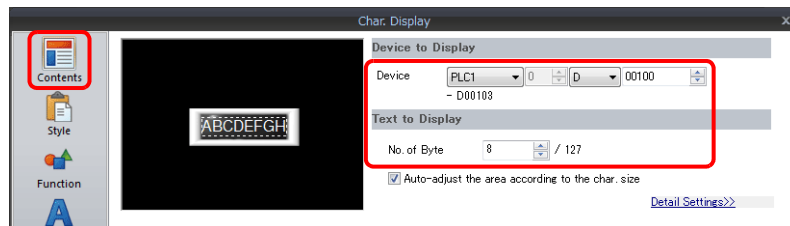

3. Set [Function] to "Entry Target".
4. Select the [Display the keyboard] checkbox and select a keyboard. When registering a new keyboard, click [Register] and select a keyboard.

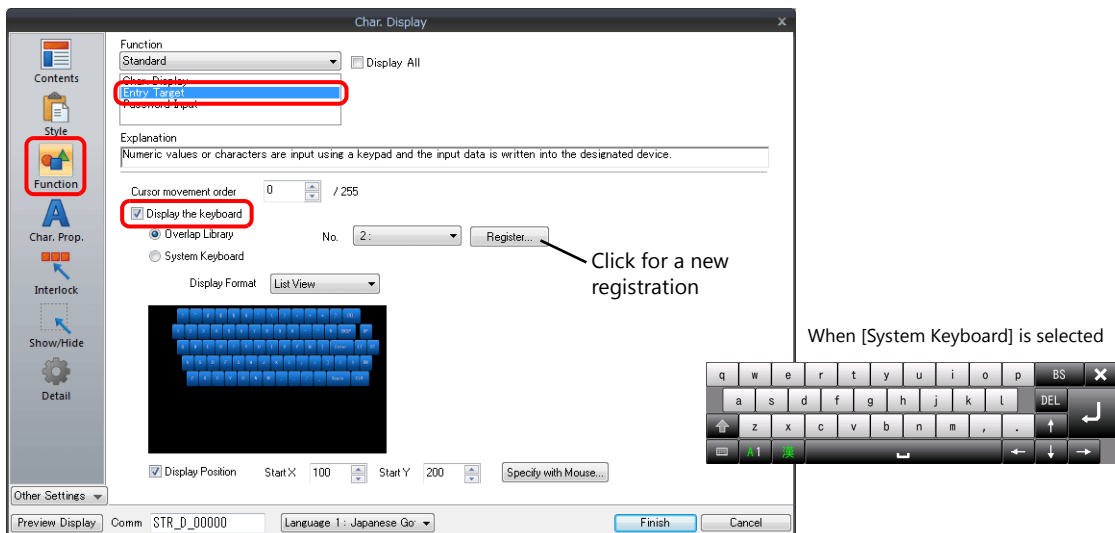

5. Select the [Display Position] checkbox and set the display position of the keyboard. (The display position cannot be set when the system keyboard is selected.)

This completes the necessary settings.



This setting cannot be performed for table data display entry targets.

## USB Keyboard Entry

Text can be entered with respect to the entry target using a USB keyboard connected to the USB-A port.

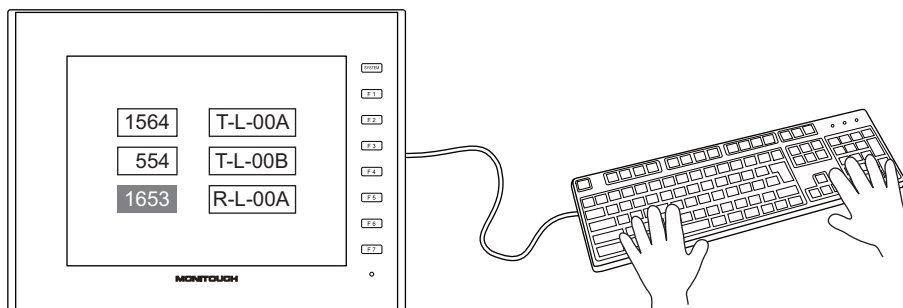

1. Click [Parts] → [Data Display ▼] → [Char. Display] and place a character display on the screen.

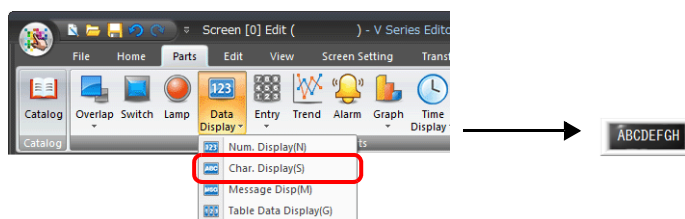

2. Display the settings window for the character display and set the device memory for writing via [Contents] → [Device].

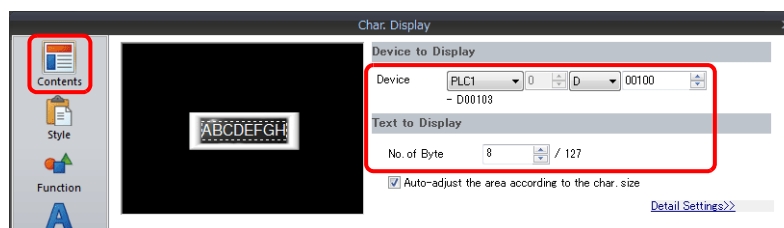

3. Set [Function] to "Entry Target" and click [Finish].
4. Click [Parts] → [Entry] → [Entry Mode] and place an icon on the screen.

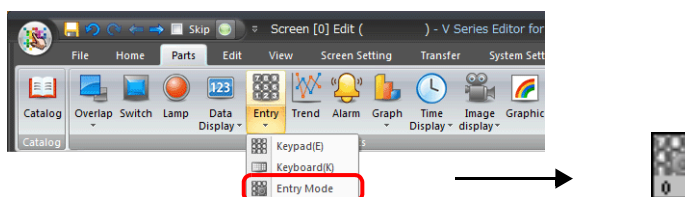

This completes the necessary settings.

\* The V9 function switches are assigned to the USB keyboard as shown below.

USB Keyboard	V9
F1	F1
F2	F2
F3	F3
F4	F4

USB Keyboard	V9
F5	F5
F6	F6
F7	F7
F8	SYSTEM

# Password Input

This procedure is described below using an example.



• Device: D300  
 • Function: Password Input (Fixed)  
 - No. 0: 1999  
 - No. 1: 1231  
 - No. 2: (None)  
 - No. 3: (None)





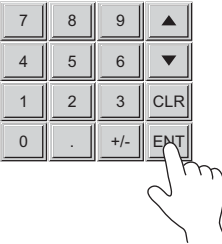

**Judgment result**

Enter "1999". → D300 = 0

Enter "1231". → D300 = 1

Enter "2000". → D300 = -1

If the entered text matches the password, the password registration number is stored. If the entered password does not match, "-1" is stored.

1. Click [Parts] → [Entry ▼] → [Keypad] and place a keypad on the screen.

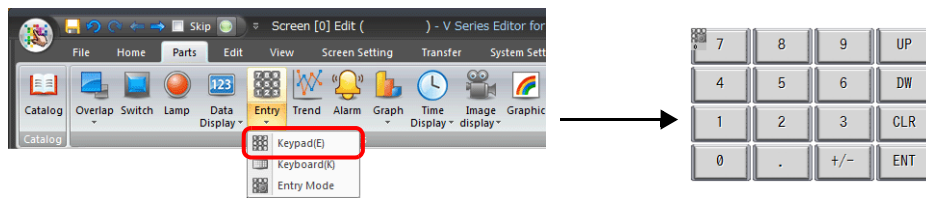

1. Display the settings window for the keypad, select the [Style] → [Additional Parts List] → [For Keyboard] → [Password Input] checkbox, and then click [Others].

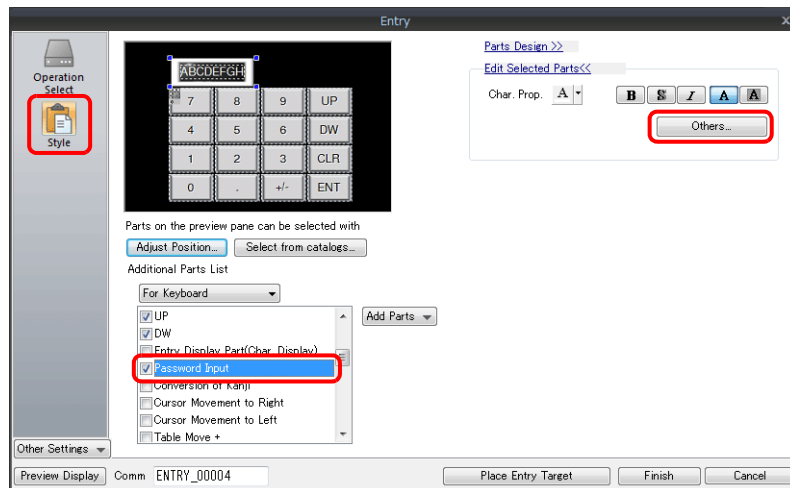

2. Register a password in the settings window of the character display under [Function].

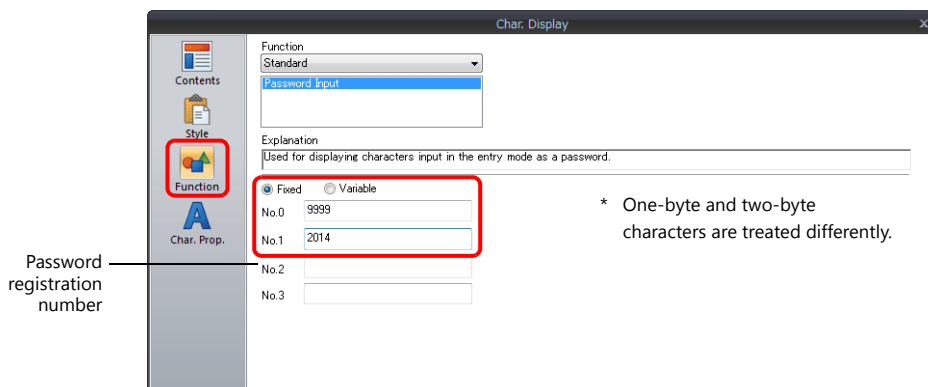

Fixed	Register the number of passwords required using the four provided password fields numbered 0 to 3 (maximum of 32 one-byte alphanumeric characters).
Variable	Select the checkboxes of the four provided passwords numbered 0 to 3 as required and store the password as an ASCII code at the specified device memory address.

3. Set the device memory for outputting the password judgment result with [Contents] → [Device]. E.g. D300.

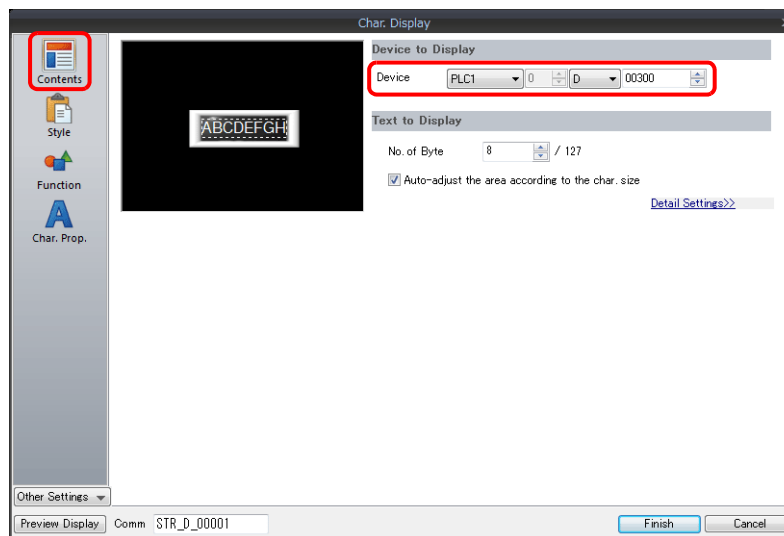

This completes the necessary settings.

The password judgment result is stored in D300.

- Password matches: When the password is accepted, No. 0 to 3 is stored.
- Password does not match: -1 (FFFF H) is stored.

## 6.2.3 Detailed Settings

### Keyboard

#### Operation Select / Detail

These are the same as for the keypad.

 For details, refer to "Operation Select" page 6-8."Detail" page 6-13

### Style

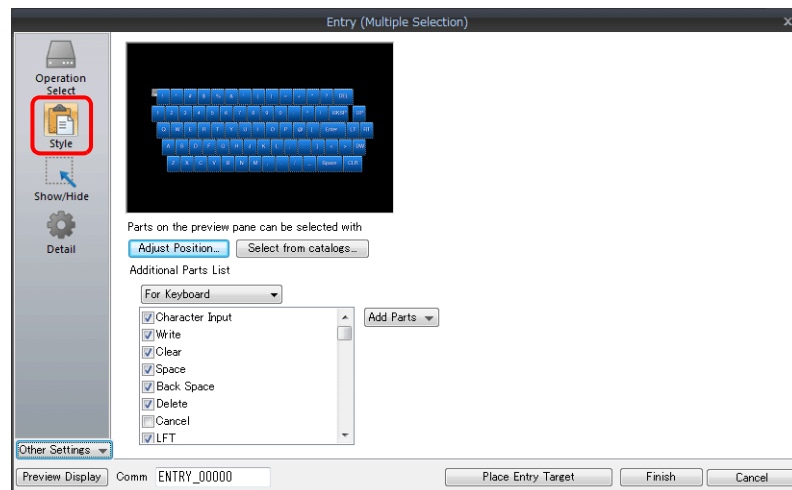

Item	Description
Adjust Position	Change the layout of the keyboard and other added parts.
Select from catalogs	Change the keyboard part.
Additional Parts List *	Select [For Keyboard]. Use this list to add or remove entry-related parts.

\* The following switches can be used on a keyboard.

Function	Description
Character Input	Enter numerical values or character codes corresponding to the text on the switch.
Write	Transfer the entered data to the specified device memory address. The screen can be changed after the execution of data writing.
Clear	Clear the entered data.
Spaces	One-byte space is entered.
Back Space	Delete the character to the left of the cursor.
DELETE	Delete the character at the current cursor position.
Cancel	Restore the initially displayed value (the value prior to entry) during an entry operation.
LFT	Move the cursor left.
RGT	Move the cursor right.
UP	Move the cursor to the previous entry target. (Cursor movement order number -1)
DW	Move the cursor to the next entry target. (Cursor movement order number + 1)
Entry Display Part (Char. Display)	Temporarily display the entered value.
Password Input	Input passwords. Input values are displayed as asterisks (*). For details, refer to page 6-26.
Conversion of Kanji	Enable kanji mode with conversion of one character at a time. * JIS level-1 kanji set only
Cursor Movement to Right	Move the cursor to the right in the table data display. For details, refer to page 6-12.
Cursor Movement to Left	Move the cursor to the left in the table data display. For details, refer to page 6-12.
Table Move +	Move the cursor to the next table data display. (Cursor movement order number + 1)
Table Move -	Move the cursor to the previous table data display. (Cursor movement order number - 1)

Function	Description
Multi-char. Input	Changeover the text for each pattern with the [Char. Switching (+)] and [Char. Switching (-)] switches. Text on switches changeover according to the conversion modes of 1-byte/2-byte and caps lock.
Switching (Entry Mode Change)	-
Switching (1-byte/2-byte Char. Change)	-
Switching (Caps Lock)	-
Direct Input	-
Word Registration	-
Char. Switching (+)	Changeover the pattern and text of the [Multi-char. Input] switch in order from "OFF" to "P15."
Char. Switching (-)	Changeover the pattern and text of the [Multi-char. Input] switch in order from "P15" to "OFF."

## Entry Target

This section only explains the essential entry settings.

## Character Display

### Contents

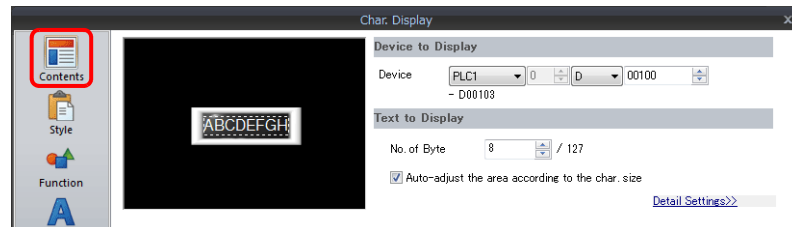

Item	Description
Device	Set the device memory for writing.
No. of Bytes	Specify the number of bytes (number of characters).

### Function

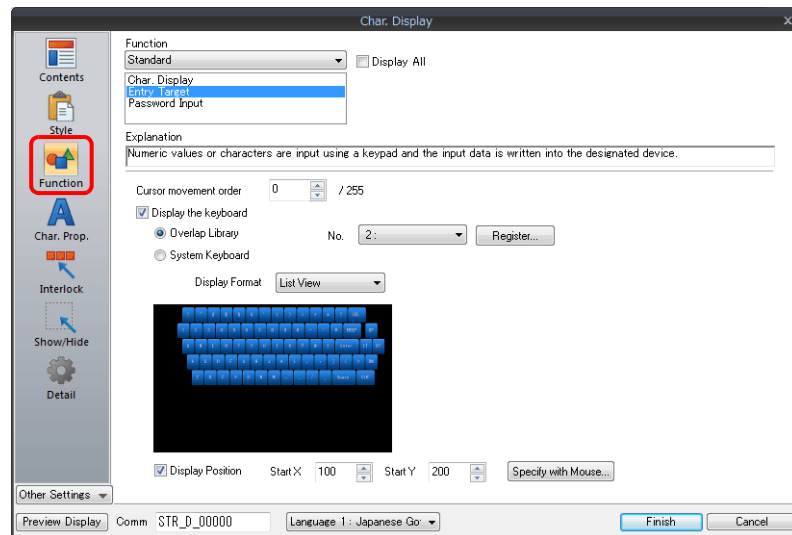

Item	Description
Function	Set the entry target.
Cursor movement order	Set the cursor movement order. The cursor can be moved with the [UP] and [DW] switches or using a control device memory.
Display the keyboard	Select a keyboard. Click [Register] when registering a new keyboard part.
Display Format	Change the list view of the overlap library.
Display Position	Unselected: Display using the position of the keyboard registered in the overlap library. Selected: Specify the keyboard display position. The display coordinates can be set with the mouse by clicking [Specify with Mouse].

### Interlock

These are the same as for the keypad.

 For details, refer to "Interlock" page 6-16.



## Table Data Display

### General settings

Location of settings: Double-click on the table data display

- Detail

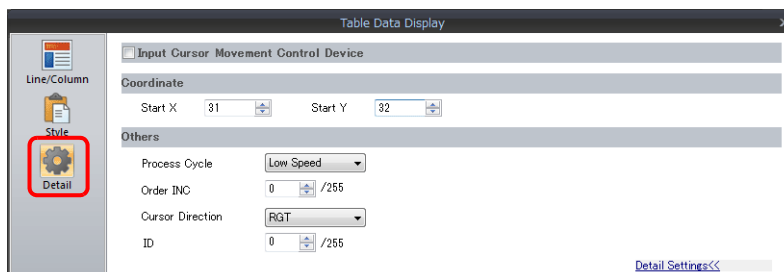

Item	Description
Input Cursor Movement Control Device	Perform cursor movement control. For details, refer to "6.3.1 Item Select Function" page 6-32.
Order INC	When the table data display contains multiple table data display parts for which [Function] is set to "Entry Target", this determines the order of precedence of each table data display part.
Cursor Direction	Select the direction in which the cursor moves when the [ENT] key is pressed. This setting is available when [Operation Select] → [Cursor Moved by] is set to "UP/SW Switch" and bit 14 (cursor movement) of [Control Device] is set to ON.
ID	Set an ID number.

### Table cells

- Select Type



Item	Description
Select Type	Select [Char. Display].

- Contents

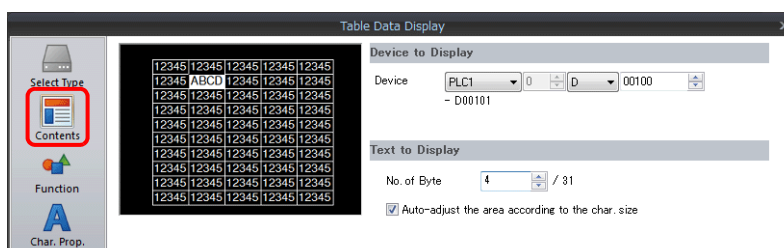

Item	Description
Device	Set the device memory for writing.
No. of Bytes	Specify the number of bytes (number of characters).

- Function

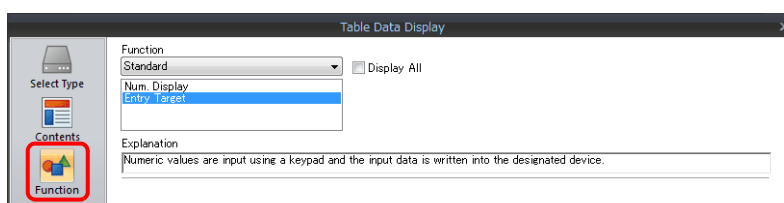

Item	Description
Function	Set the entry target.

## 6.3 Convenient Functions

### 6.3.1 Item Select Function

#### Overview

The cursor can be moved to a specific entry target. This is called the “item select function.”

There are two methods for moving the cursor: using a switch or using an external command from the device memory specified for [Input Cursor Movement Control Device] (page 6-33).

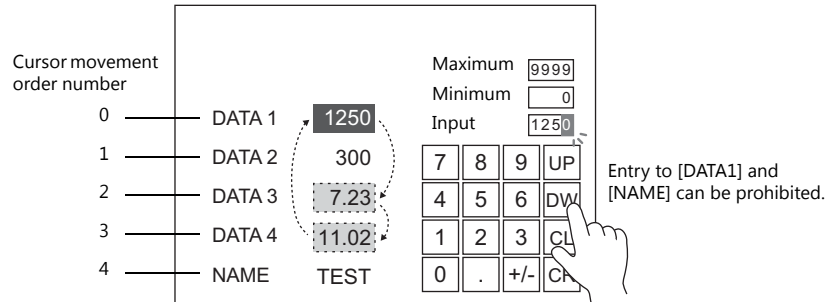

#### Item Select Function with a Switch

A switch with [Function] set to “Item Select” can be overlaid on a specific entry target so that the cursor can be moved to the entry target.

#### Setting Procedure

This procedure is described below using an example.

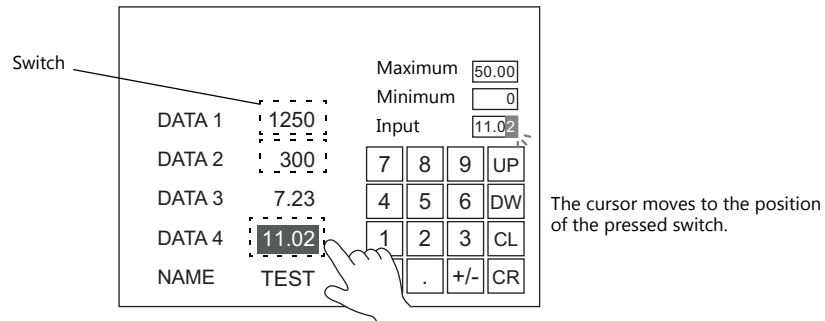

1. Set [Function] to “Item Select” for the switch.

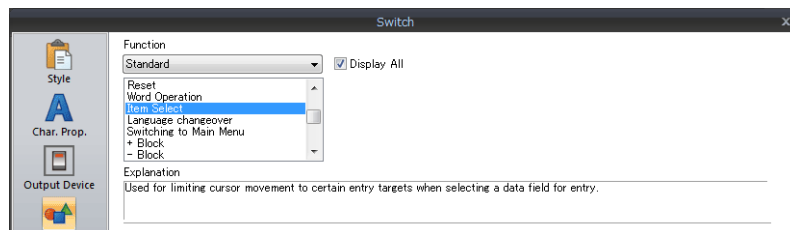

2. Place the switch so that it overlaps an entry target.

This completes the necessary settings.

Pressing the entry target moves the cursor to the pressed position.

#### Notes

- Place the switch set with “Item Select” for [Function] on the same editing layer (screen, overlap ID 0 to 9) as the keypad.
- For the keypad, set [Operation Select] → [Entry Target] to “Data Display” and [Cursor Moved by] to “UP/DW Switch”.

## Item Select with [Input Cursor Movement Control Device]

Set a [Input Cursor Movement Control Device] at the position of the placed entry target. The cursor can be moved to the specific entry target by setting the relevant [Input Cursor Movement Control Device] bit either ON or OFF.

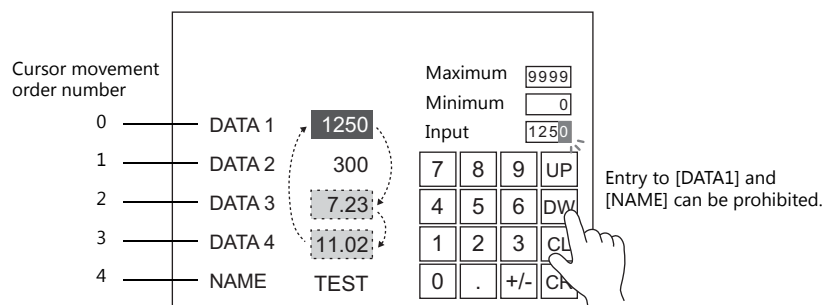

### Location of Setting

The location of this setting differs depending on the placement location of the entry target. Specify the top device memory address for [Input Cursor Movement Control Device] at the location of this setting.

Entry Target		Location of the [Input Cursor Movement Control Device] Setting
Type	Placement Location	
Numerical Data Display Character Display	Screen	[Screen Setting] → [Screen Setting] → [Entry] → [Input Cursor Movement Control Device]
	Normal overlap	Normal overlap settings window → [Detail] → [Input Cursor Movement Control Device]
	Multi-overlap	Multi-overlap settings window → [Detail] → [Input Cursor Movement Control Device]
	Call-overlap	Call-overlap settings window → [Detail] → [Input Cursor Movement Control Device]
	Global overlap	Global overlap settings window → [Detail] → [Input Cursor Movement Control Device]
	Data Block Area	Data block area settings window → [Detail] → [Input Cursor Movement Control Device] under [Device Setting]
Table Data Display	-	Table data display settings window → [Detail] → [Input Cursor Movement Control Device]

### Details of the [Input Cursor Movement Control Device] Setting

The control method differs depending on whether the entry target is a numerical data display, character display, or table data display.

One bit is assigned to each entry target and cursor movement is controlled by the ON/OFF state of this bit.

### When the entry target is a numerical number display or character display

[Input Cursor Movement Control Device] is associated with [Entry Target] and the [Cursor movement order] number in the following way.

0: Cursor movement prohibited

1: Cursor movement allowed

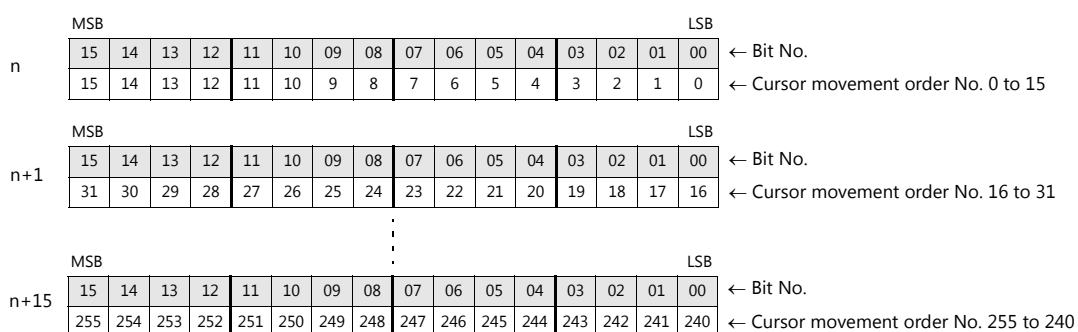

## When the entry target is a table data display

Assignment depends on the number of columns of the table data display part.

- 0: Cursor movement prohibited
- 1: Cursor movement allowed

- Table with 1 to 16 columns

For a table with 1 to 16 columns, one word is used for each line.  
The total number of words used is the same as the number of lines.

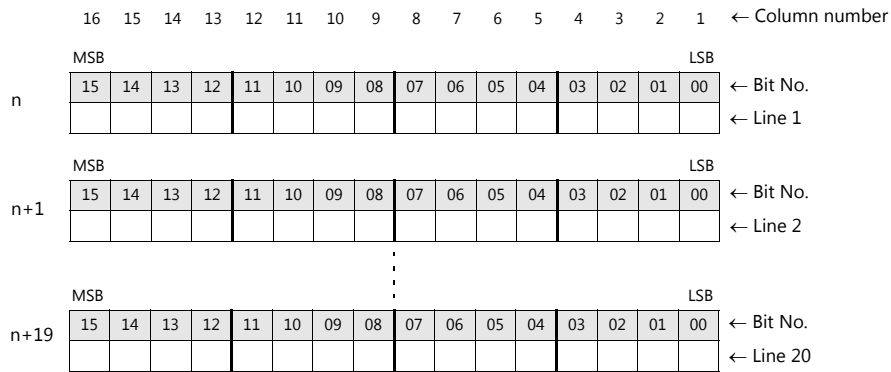

- Table with 17 to 25 columns

For a table with 17 or more columns, 2 words are used for each line.  
The total number of words used is "2 ÷ number of lines".

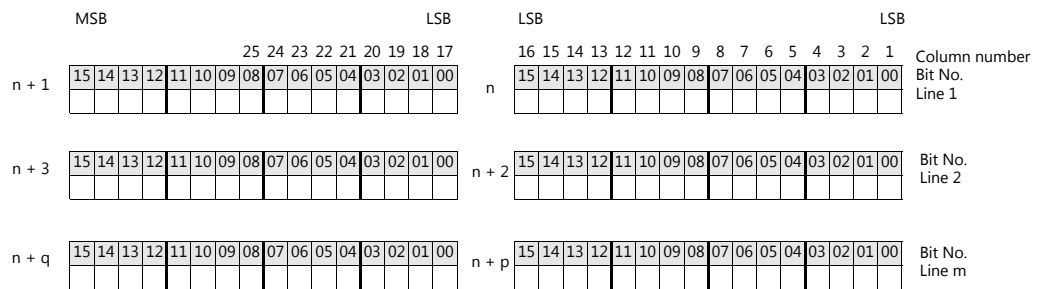

## Usage Example

An example of when a numerical data display or character display entry target and a keypad are placed on the screen is explained below.

1. Set [Screen Setting] → [Screen Setting] → [Entry] → [Input Cursor Movement Control Device]. Example: PLC device memory D200
2. Only the 0th, 2nd, and 3rd bits of the device memory for input cursor movement control are set to ON from the unit.

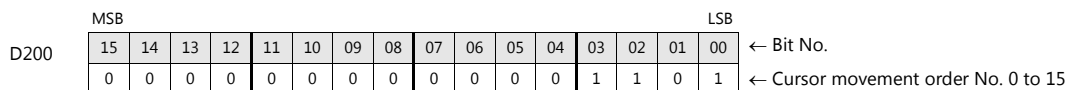

The cursor moves according to the cursor movement order numbers 0, 2, and 3.

## Notes

In this case, the [Cursor movement order] number of each table data display is ignored.  
The line and column numbers are also assigned to those consisting of text only.

# 7 Trends

---

7.1 Overview

7.2 Historical Display

7.3 Real Time Display

# 7.1 Overview

There are two types of trend sampling: historical display (logging server) and real time display.

## Historical Display

- The values of device memory addresses registered to a logging server can be saved as history. Logging can be performed at a fixed cycle or using a trigger bit (0 → 1).

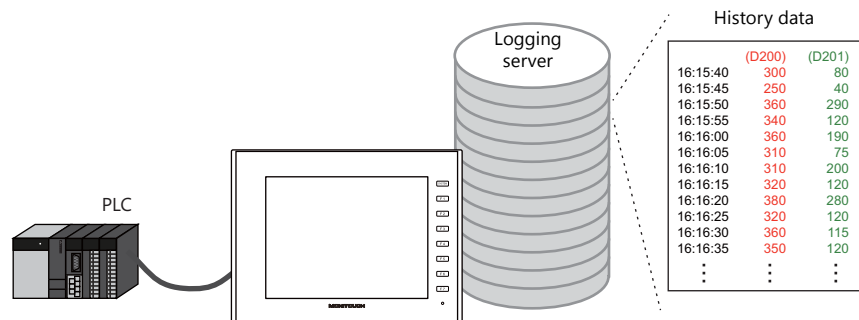

For details, refer to "7.2 Historical Display" page 7-2.

- History data saved to a logging server using trend sampling parts can be displayed on a graph or as data.

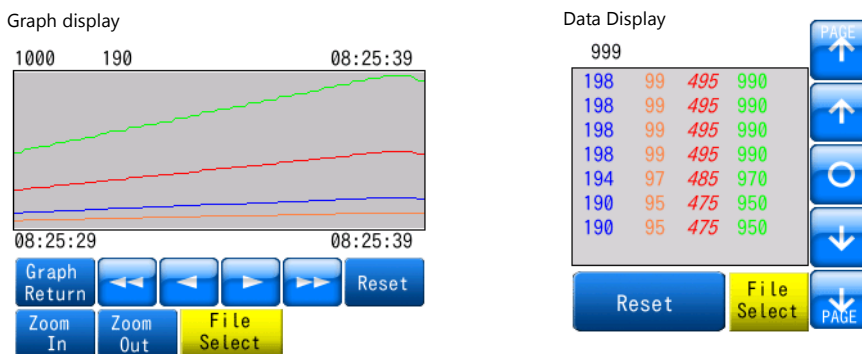

For details, refer to the following references.

- "7.2.2 Graph Display" page 7-15
- "7.2.3 Data Display" page 7-24

## Real Time Display

Values in consecutive device memory addresses can be expressed on a line graph.

Example: Graph display of data in addresses D100 to D110

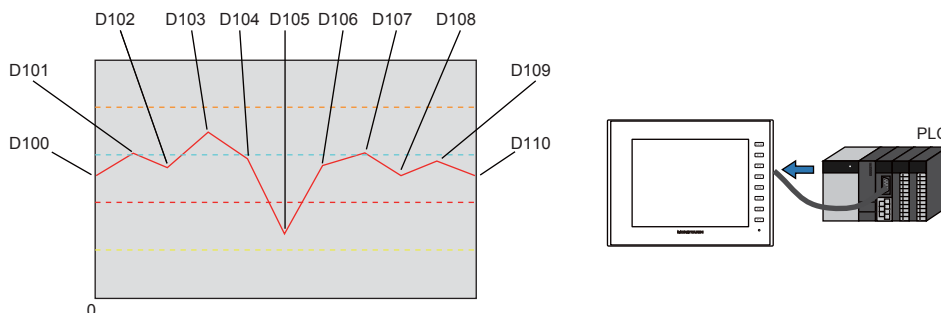

For details, refer to "7.3 Real Time Display" page 7-31.

## 7.2 Historical Display

### 7.2.1 Logging Server

- The area for saving logged data is referred to as the logging server. A maximum of 12 logging servers can be registered. Logging is performed using a fixed cycle or a trigger bit (0 → 1) and device memory can be freely configured.

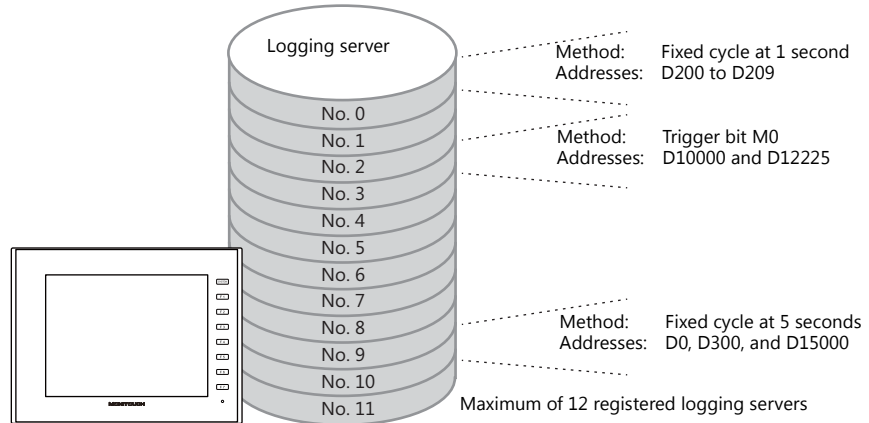

- CSV/backup output
  - History data saved to a logging server can be output to a storage device as a CSV or backup file.

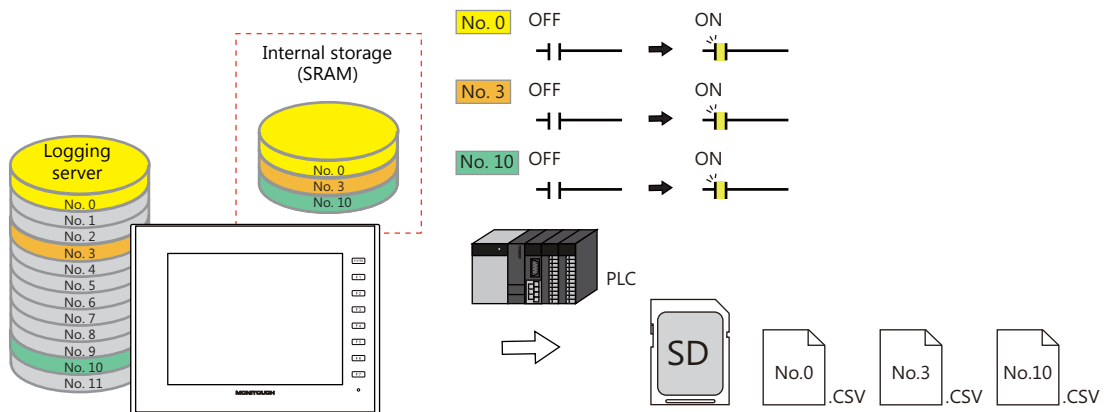

For details, refer to [“Outputting CSV/Backup Files” page 7-5](#).

- The drive for outputting CSV and backup files can be set. CSV and backup files can be output with an SD card inserted in the SD card socket at all times or with a USB memory device, which can be connected only when needed.

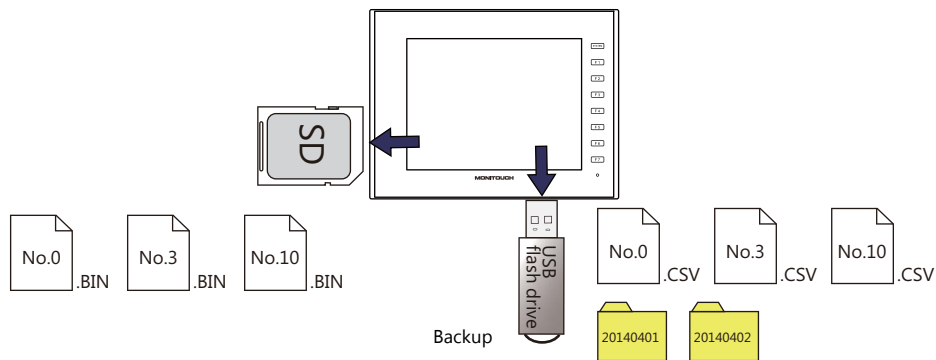

- History data saved to a logging server using trend sampling parts can be displayed on a graph or as data.

For details, refer to the following references.

- “7.2.2 Graph Display” page 7-15
- “7.2.3 Data Display” page 7-24

## Setting Example

### Logging Methods

There are two logging methods: logging performed at a fixed cycle and logging performed upon triggering of a trigger bit (0 → 1).

#### Fixed cycle

This section explains logging with a fixed cycle using an example of logging data from device memory addresses D200 to D209 at 1 second intervals.

1. Display the [System Setting] → [Logging Server] window.
2. Click [Add] and set an unregistered number.
3. Set [Logging] to [Constant Cycle].
4. Configure the [Logging Data] tab window settings as shown below.

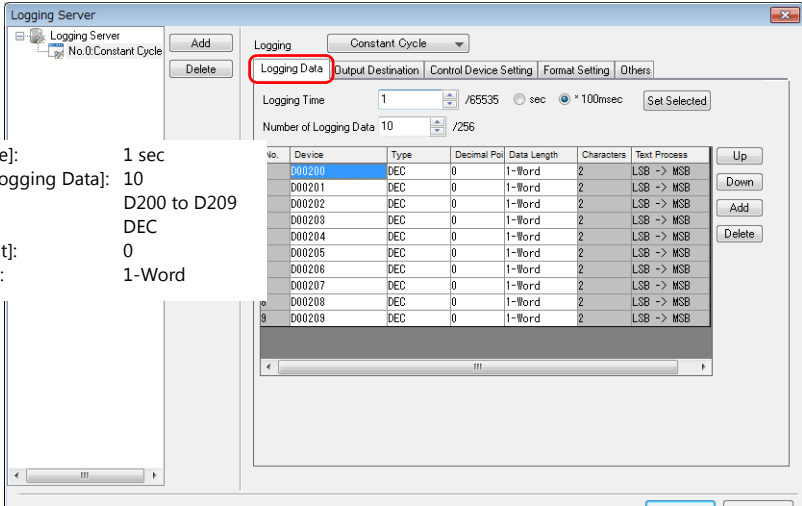

- [Logging Time]: 1 sec
- [Number of Logging Data]: 10
- [Device]: D200 to D209
- [Type]: DEC
- [Decimal Point]: 0
- [Data Length]: 1-Word

No.	Device	Type	Decimal Poi	Data Length	Characters	Text Process
D00200	DEC	0	1-Word	2	LSB → MSB	
D00201	DEC	0	1-Word	2	LSB → MSB	
D00202	DEC	0	1-Word	2	LSB → MSB	
D00203	DEC	0	1-Word	2	LSB → MSB	
D00204	DEC	0	1-Word	2	LSB → MSB	
D00205	DEC	0	1-Word	2	LSB → MSB	
D00206	DEC	0	1-Word	2	LSB → MSB	
D00207	DEC	0	1-Word	2	LSB → MSB	
D00208	DEC	0	1-Word	2	LSB → MSB	
D00209	DEC	0	1-Word	2	LSB → MSB	

5. Set [Number of Data to Save] on the [Output Destination] tab window.

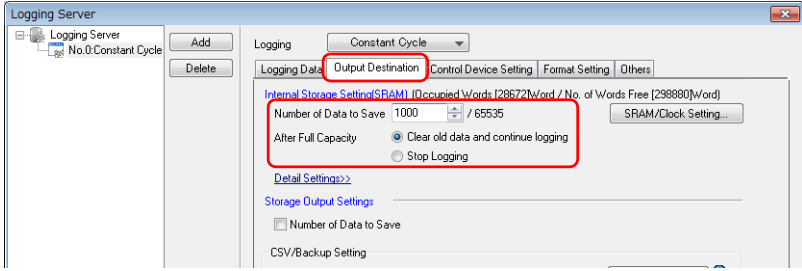

Number of Data to Save: 1000 / 65535

After Full Capacity:  Clear old data and continue logging

Stop Logging

Number of Data to Save	Set the number of data entries to save in logging.
After Full Capacity	Set the operation to perform when the value of [Number of Data to Save] is exceeded.  Erase old data entries and continue or stop logging.

This completes the necessary settings.

- ☞ To output logging data to a storage device, refer to [“Outputting CSV/Backup Files” page 7-5](#).
- ☞ To display logging data on a graph or as data, refer to the following references.
  - [“7.2.2 Graph Display” page 7-15](#)
  - [“7.2.3 Data Display” page 7-24](#)



## Trigger

This section explains logging with a trigger using an example of logging data from device memory addresses D10000 and D12225 when trigger bit M0 changes from 0 to 1.

1. Display the [System Setting] → [Logging Server] window.
2. Click [Add] and set an unregistered number.
3. Set [Logging] to [Trigger].
4. Configure the [Logging Data] tab window settings as shown below.

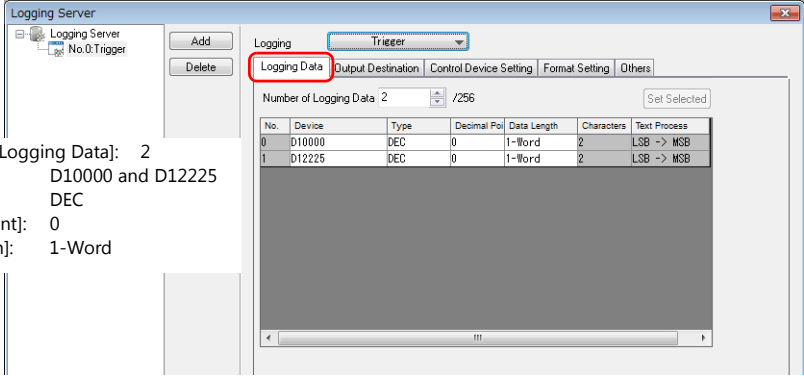

- [Number of Logging Data]: 2
- [Device]: D10000 and D12225
- [Type]: DEC
- [Decimal Point]: 0
- [Data Length]: 1-Word

5. Set [Number of Data to Save] on the [Output Destination] tab window.

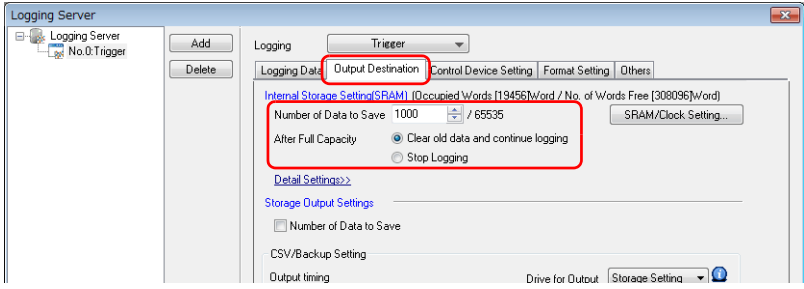

Number of Data to Save	Set the number of data entries to save in logging.
After Full Capacity	Set the operation to perform when the value of [Number of Data to Save] is exceeded.  Erase old data entries and continue or stop logging.

6. Set [Trigger Bit] on the [Control Device Setting] tab window. M0

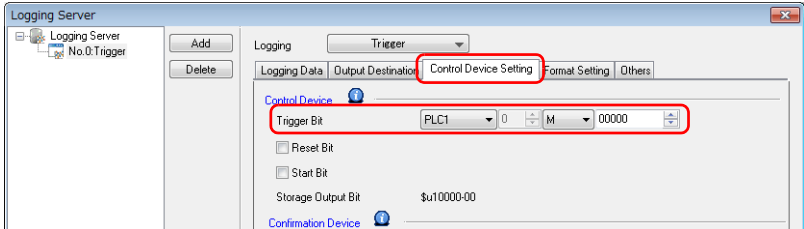

This completes the necessary settings.

- ☞ To output logging data to a storage device, refer to [“Outputting CSV/Backup Files” page 7-5.](#)
- ☞ To display logging data on a graph or as data, refer to the following references.
  - [“7.2.2 Graph Display” page 7-15](#)
  - [“7.2.3 Data Display” page 7-24](#)

## Outputting CSV/Backup Files

Output logging data saved in SRAM (DRAM) to a storage device.

☞ For an example on setting the logging method, refer to the following references.

- “Fixed cycle” page 7-3
- “Trigger” page 7-4

1. Display the [System Setting] → [Logging Server] window and specify a logging server number.
2. Set the settings under [CSV/Backup Setting] → [Output timing] on the [Output Destination] tab window.

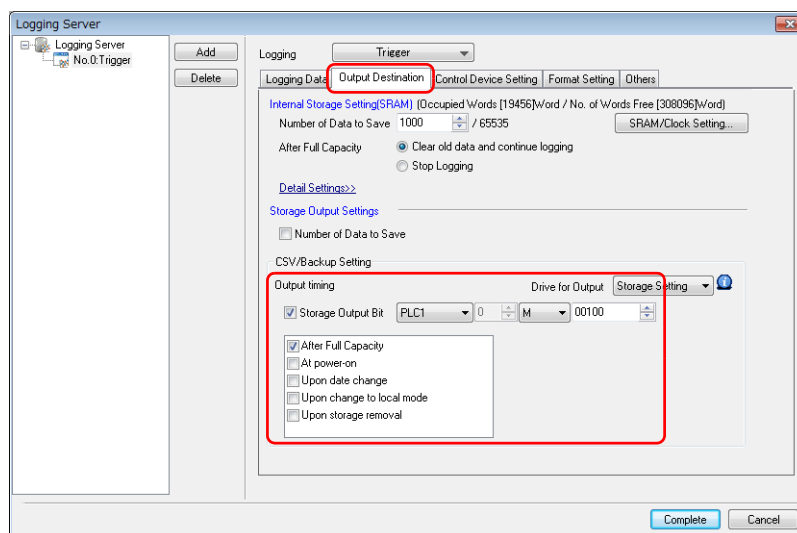

Output timing	Storage Output Bit (0 → 1) After Full Capacity At power-on Upon date change Upon change to local mode (when mode is changed from RUN to Local) Upon storage removal (when storage removal switch is pressed)
---------------	---

3. Set the save target with [Drive for Output].

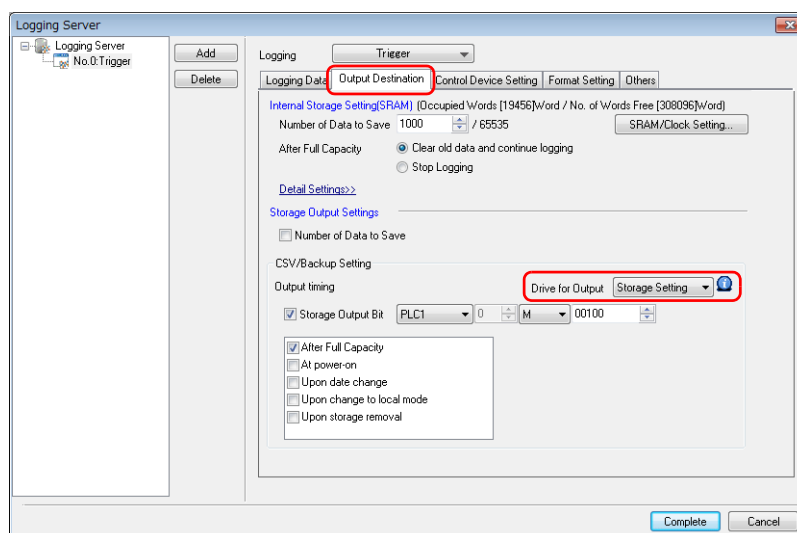

Drive for Output	Storage Setting: [System Setting] → [Other] → [Storage Setting] C: Built-in Socket D: USB-A port
------------------	--

4. Double-click the format number on the [Format Setting] tab window and set the format of the CSV file.

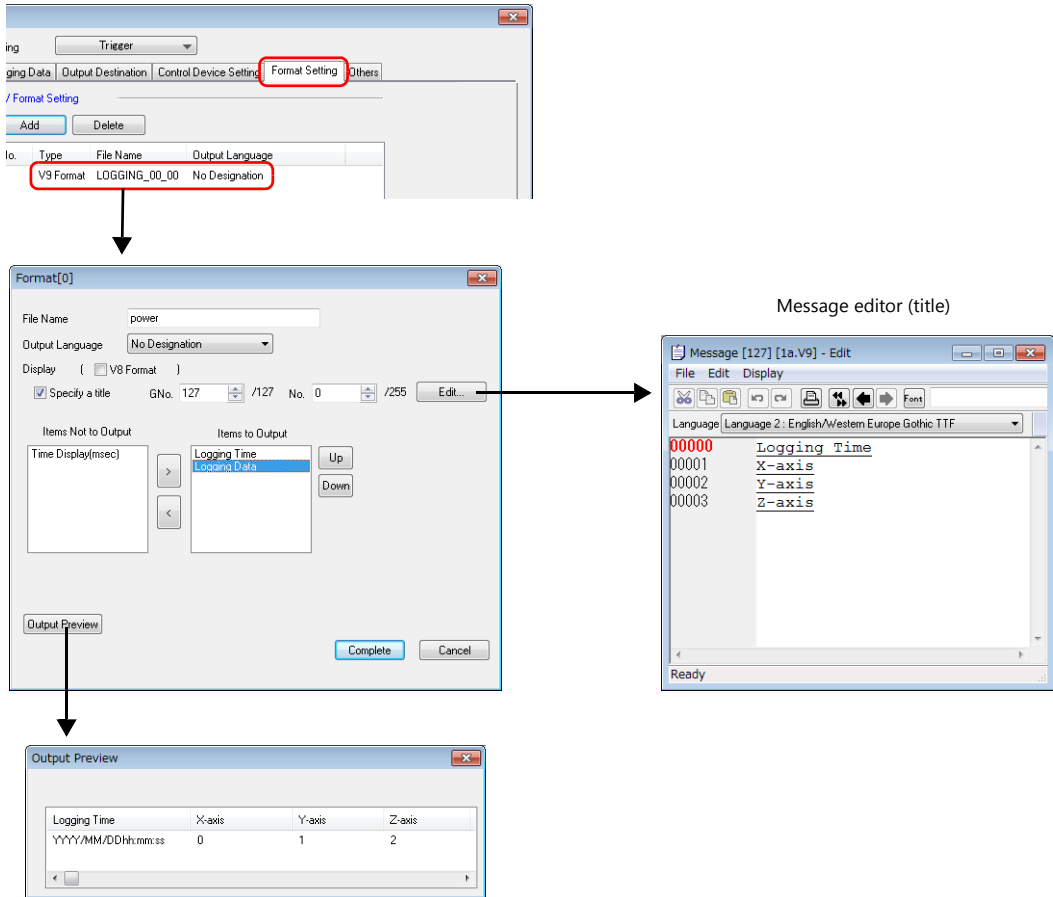

File Name	Set the name of the CSV file.
Output Language	Set the language used in the CSV file. No Designation: Output using the displayed language. Language 1 to 16
Specify a title	Add titles to the first line (line 1) of the CSV file. Selected: Add titles to the first line of the CSV file. Unselected: No titles
Items Not to Output Items to Output ← →	Use the [←] and [→] buttons to set the items to output to the CSV file. Logging Time Time Display (msec) Logging Data  * Logging time and time display are output separately.
Output Preview	Display a preview of CSV file to be output.

This completes the necessary settings.  
A CSV file/backup file is output at the timing set in step 2.

For details on folder configuration, refer to "Storage output settings" page 7-10.



To only output a CSV file, select the [Others] → [Do not output backup files] checkbox.

## Detailed Settings

Location of settings: [System Setting] → [Logging Server]

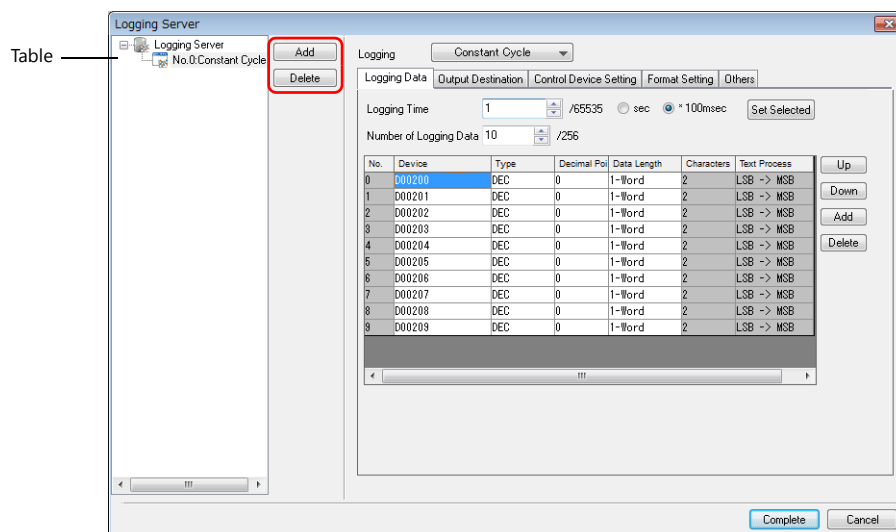

### Table

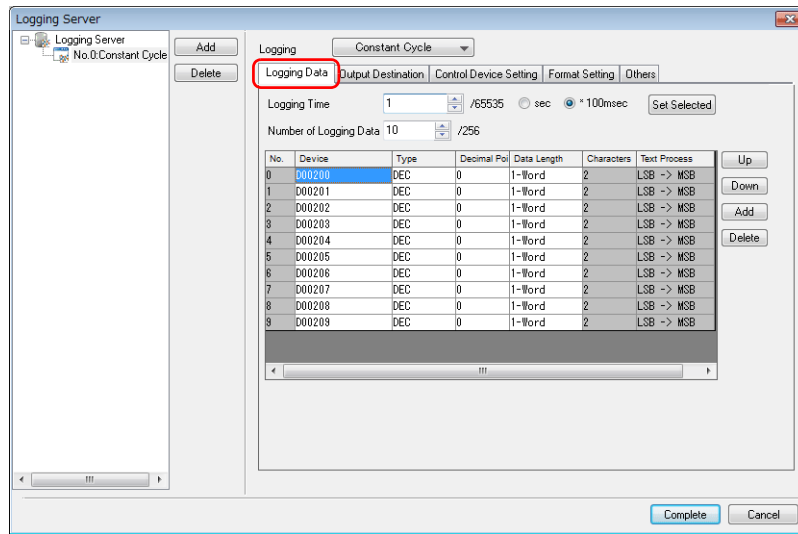

Item	Description
Add	Create a new logging server. A maximum of 12 logging servers can be registered.
Delete	Delete the selected logging server.

## Logging Data



Item	Description
Logging	<p>Set the logging method.</p> <p>Trigger                      Perform logging when the [Trigger Bit] device memory changes from 0 to 1.                      Location of setting: <a href="#">"Control Device Setting" page 7-12</a></p>  <p>Constant Cycle                      Perform logging at the cycle set for [Logging Time].</p> 
Logging Time	Set the logging frequency. 0 to 65535 (0 means every cycle) Units: Seconds or 100 milliseconds
Number of Logging Data	Set the total number of points to log. Max. 256 points.
Device	Set the logging device memory.
Type	Set the data type.
Decimal Point	Set the number of decimal places.
Data Length	Set the data length of the set device memory. 1-Word/2-Word
Characters	Set the number of characters (1 character = 1 byte).
Text Process	Set the order of the first and second bytes within one word. LSB → MSB, MSB → LSB
Set Selected	Batch copy the settings of the selected cell. For device memory addresses, automatic increment is performed.
Up, Down	Move the selected line.
Add	Add a new line below the selected line.
Delete	Delete the selected line.

## Output Destination

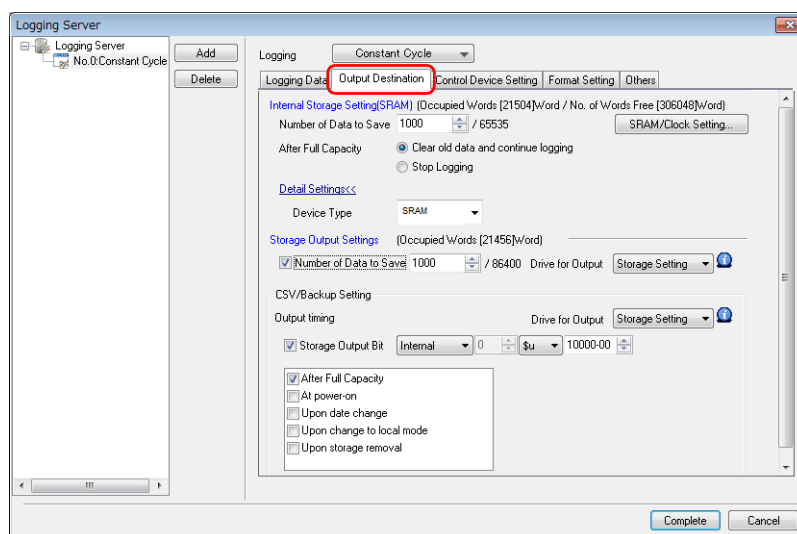

### Internal storage settings

Configure the settings for storing to SRAM (DRAM).

Item	Description
Number of Data to Save	Set the number of data entries to save in logging.
After Full Capacity	Set the operation to perform when the value of [Number of Data to Save] is exceeded. Erase old data entries and continue or stop logging.
Device Type	Set the save destination for logging.  SRAM Back up history data when power to the unit is OFF (on battery power) and when changing between RUN and Local mode. The amount of free space and total used space can be checked via [SRAM/Clock Setting]. DRAM All history data is cleared when power to the unit is turned OFF or when changing between RUN and Local mode.

## Storage output settings

Configure the settings for outputting to a storage device. \*

Item	Description
Number of Data to Save	<p>Set the amount of data saved in the internal storage settings to save to a BIN file. The timing of file output is as follows.</p> <ul style="list-style-type: none"> <li>- When amount of saved internal storage settings data has reached its limit</li> <li>- When switching the V9 series unit from RUN to STOP, or when turning power ON (only when SRAM is selected)</li> <li>- When the [Storage Removal] switch is pressed</li> <li>- When a reset is performed (reset switch/reset bit ON)</li> <li>- When the SAMPLE macro (V8 compatible) is executed</li> </ul> <p>(To only output CSV and backup files, this setting is not required. Configure the CSV/backup settings.)</p>
Drive for Outputs	<p>Select the output target.</p> <p>Storage settings: [System Setting] → [Other] → [Storage Setting] → [Storage Connection Target] C: Built-in Socket D: USB-A port</p> <p>The folder configuration on storage devices is as follows. BIN file destination: (output drive)\access folder\LOGGING folder</p> <pre> graph TD     EXT0000[EXT0000 Access folder (default) *1] --- LOGGING[LOGGING LOGGING folder (fixed name)]     LOGGING --- LOGGING00[LOGGING00.BIN (LOGGING00.BIN-journal *2)]     LOGGING00 --- LOGGING_SERVER[Logging server No. 00 to 11]   </pre> <p>*1 The folder name can be changed at [System Setting] → [Other] → [Storage Setting]. *2 Temporary file created during data update. This file is created temporarily only when the [System Setting] → [Unit Setting] → [General Setting] → [Output logging data in binary format] checkbox is unselected.</p>

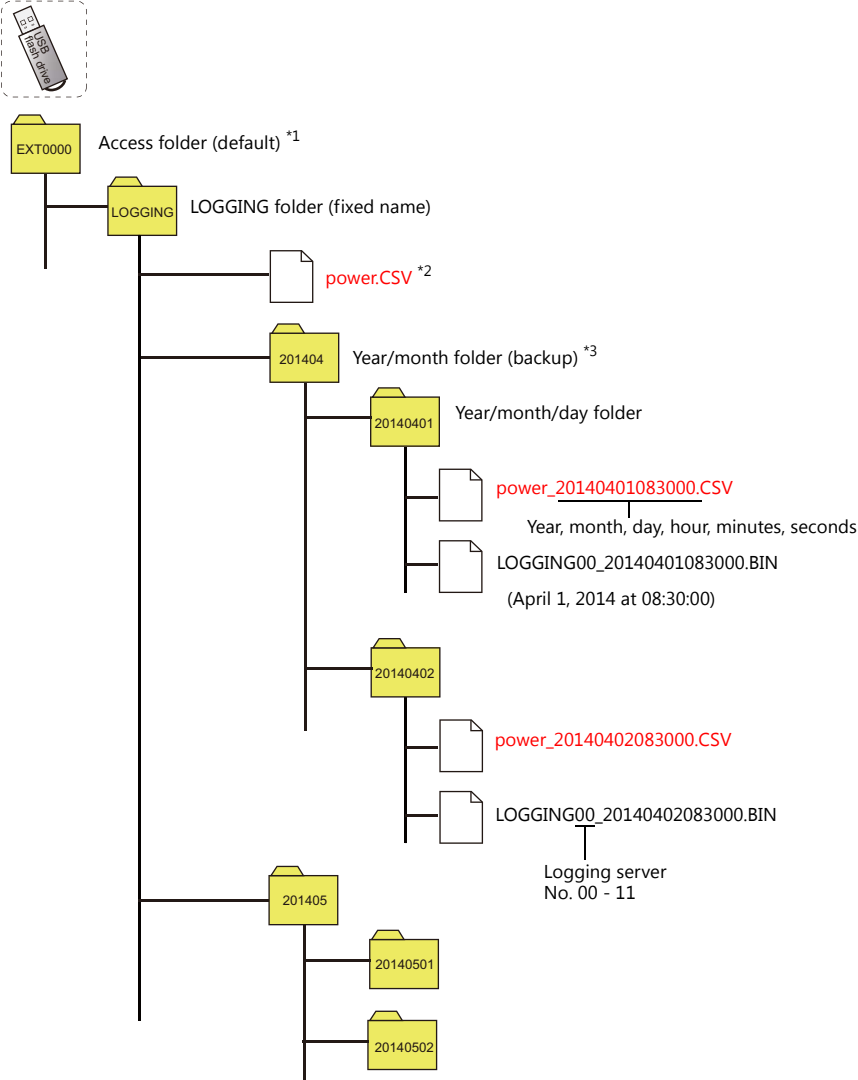
Item	Description
CSV/Backup Setting	Output data saved in the internal storage settings to a CSV/backup file on the storage device.
Output timing	Set the timing for outputting to the storage device.  Storage Output Bit (0 → 1) / After Full Capacity / At power-on / Upon date change / Upon change to local mode / Upon storage removal
Drive for Output	Select the output target.  Storage settings: [System Setting] → [Other] → [Storage Setting] → [Storage Connection Target] C: Built-in Socket D: USB-A port  The folder configuration on storage devices is as follows. <ul style="list-style-type: none"> <li>• CSV output destination (output drive)\access folder\LOGGING folder</li> <li>• Backup output destination (output drive)\access folder\LOGGING\year/month folder\year/month/day folder</li> </ul> E.g.: Logging server number 0, CSV filename: power, output drive: USB-A port   <p>*1 The folder name can be changed at [System Setting] → [Other] → [Storage Setting].</p> <p>*2 For details on changing the filename, refer to <a href="#">"Format Setting" page 7-13</a>.</p> <p>*3 If a backup is not required, select the [Others] → [Do not output backup files] checkbox. For details, refer to <a href="#">"Others" page 7-14</a>.</p>



## Control Device Setting

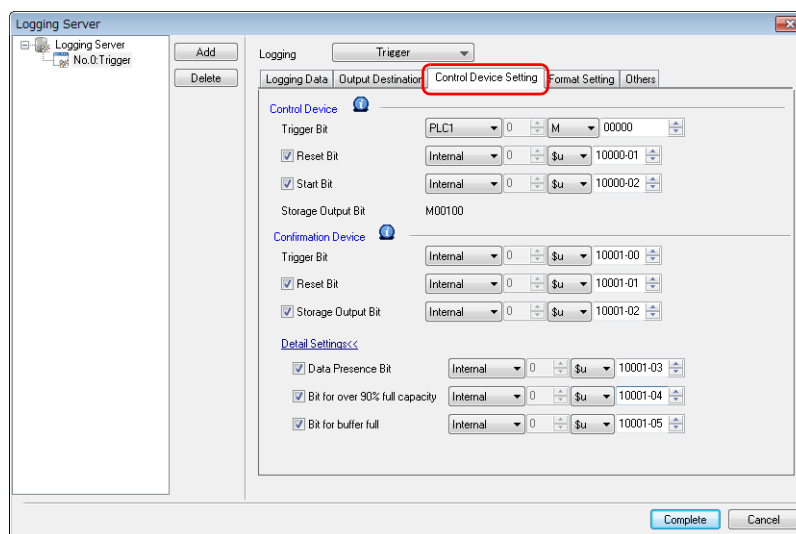

### Control device

Item	Description
Trigger Bit	Set the trigger bit to use when [Logging] is set to [Trigger]. Logging is performed when the trigger bit changes from 0 to 1. 0 → 1: Perform logging once.
Reset Bit	Clear the history data. 1: Reset (logging is stopped while "1")
Start Bit	Control starting and stopping of logging. 0: Stop 1: Start
Storage Output Bit	Display the storage output bit. Change the device via [Output Destination] → [Storage Output Bit]. For details, refer to <a href="#">page 7-9</a> .

### Confirmation device

This device memory stores the execution result of the control device memory.

Item	Description
Trigger Bit	Stores the trigger bit status.
Reset Bit	This bit changes to "1" after a reset is complete.
Storage Output Bit	This bit changes to "1" after the storage output bit turns ON.
Data Presence Bit	This bit changes to "1" when there is history data present at the saving destination.
Bit for capacity over 90% full	This bit changes to "1" when the saving destination is 90% full with history data.
Bit for buffer full	This bit changes to "1" when the saving destination is full.

## Format Setting

### Format list

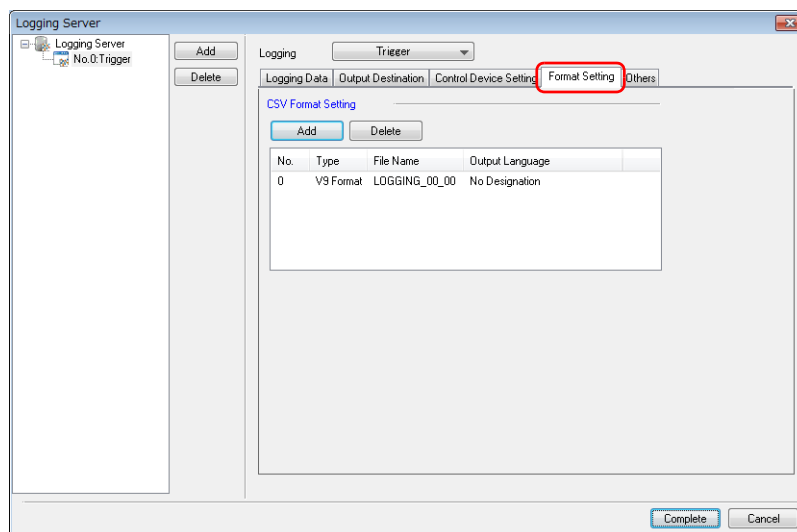

Item	Description
Add	Create a new format.
Delete	Delete the selected format. (No. 0 cannot be deleted.)

### Format window

Double-click a format number in the list to display this window.

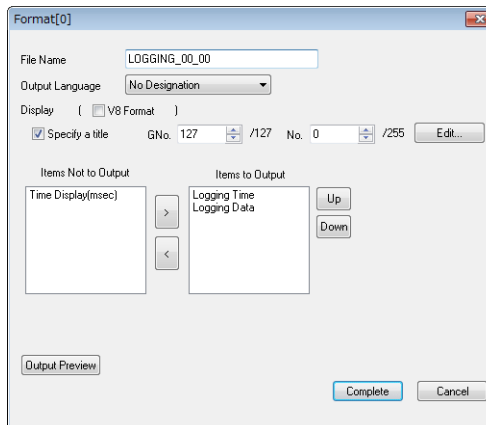

Item	Description
File Name	Set the name of the CSV file. Default: LOGGING_xx_yy.CSV (xx: logging server number, yy: format number) * For details on file output destinations, refer to <a href="#">page 7-9</a> .
Output Language	Set the language used in the CSV file. Language 1 to 16 No Designation: Language displayed on the unit.
Display	Switch to the V8 series (previous model) settings menu.
Specify a title	Add titles to the first line (line 1) of the CSV file. Titles are registered in the message editor (GNo., No.).
Items Not to Output Items to Output ← →	Use the [←] and [→] buttons to set the items to output to the CSV file. Logging Data, Logging Time, Display Time (msec) * Output all logging data. Cells are divided into logging time and time display (msec).
Up, Down	Set the item order in the CSV file. Select an item under [Items to Output] and use the [Up] and [Down] buttons to move it. Items are displayed from the left in the file in the descending order of the list.
Output Preview	Display a preview of CSV file to be output.

## Others

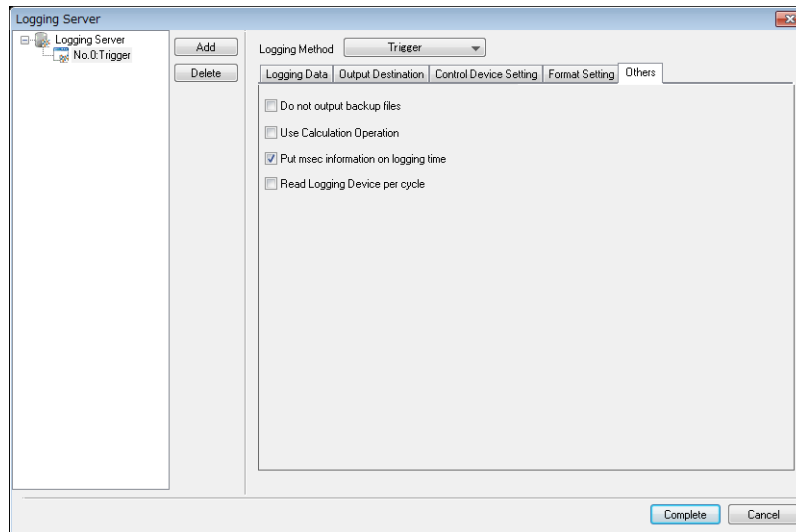

Item	Description
Do not output backup files	No backup folder or file is created when outputting to a storage device. For details on folder configuration, refer to <a href="#">page 7-10</a> .
Use Calculation Operation	Select this checkbox to display [Mean Value Display/Max. Display/Min. Display/Total Display] for a numerical data display for which [Function] is set to "Logging".
Put msec information on logging time	This is a V8 compatible setting. Select this checkbox to output the logging time in milliseconds when using a V8 sample macro.
Read Logging Device per cycle	Unselected (default) Read the logging device memory at the frequency specified for [Logging Time].  Selected Read the logging device memory according to the communication cycle.

## 7.2.2 Graph Display

- History data saved to a logging server can be displayed as a line graph or rectangular waves.
- A maximum of 16 graph lines can be displayed in one graph area.

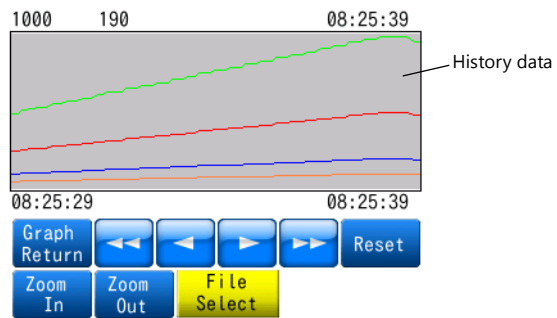

- Backup files output to a storage device can be selected for display.

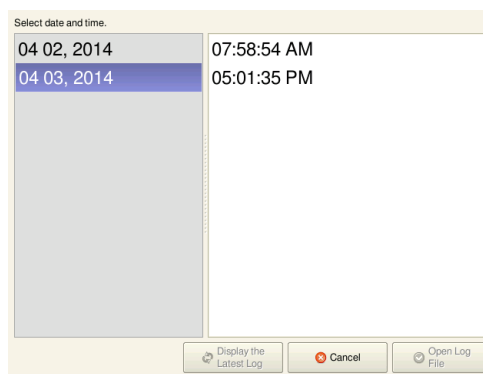

- Each graph line can be shown or hidden. Showing or hiding graphs can be easily changed as necessary, according to operating conditions.

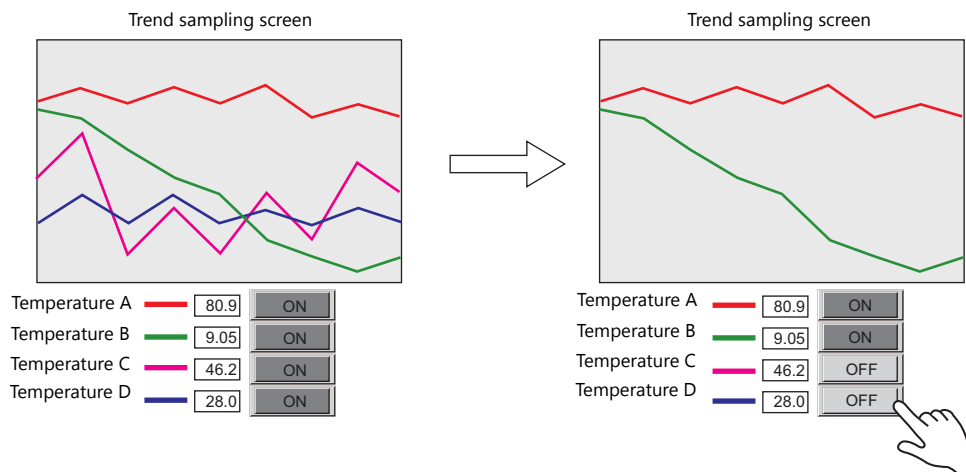

## Location of Setting

Click [Parts] → [Trend] and place a graph on the screen.

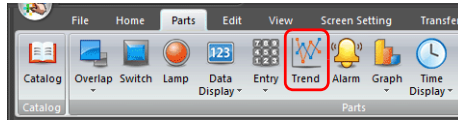

## Detailed Settings

### Operation Select

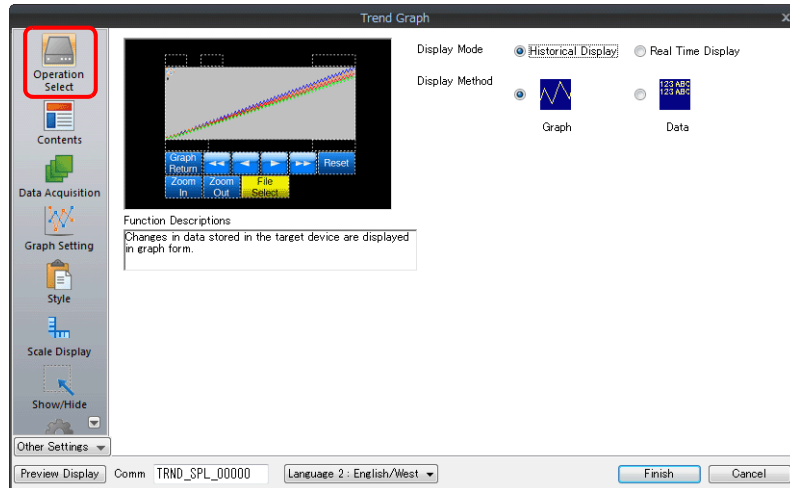

Item	Description
Display Mode	Select [Historical Display].
Display Method	Select [Graph].

### Contents

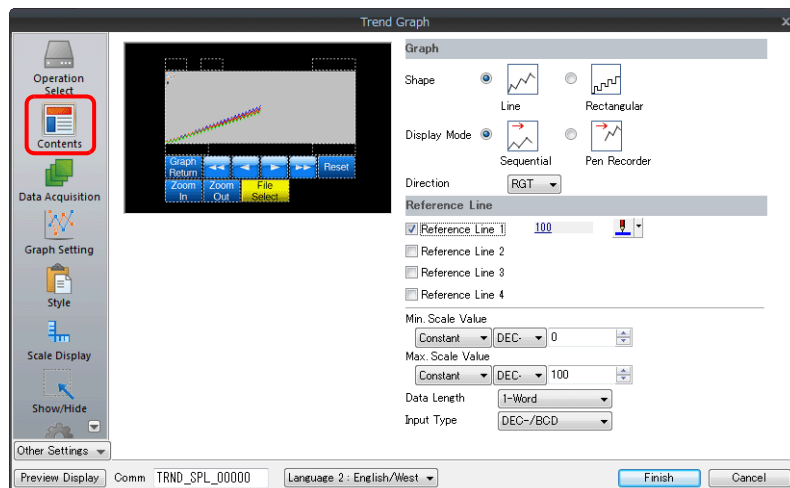

## Graph

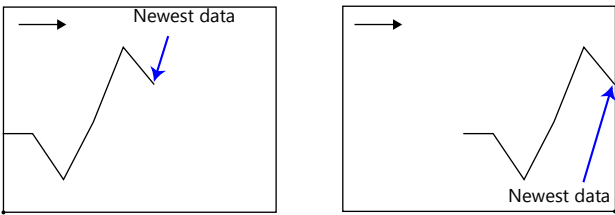
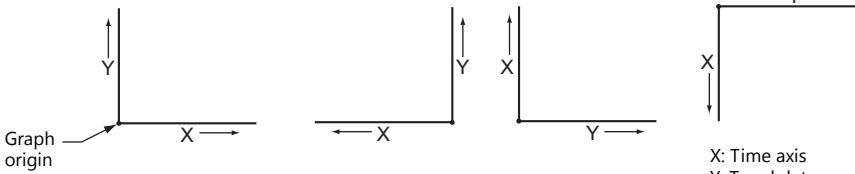
Item	Description
Shape	Set the graph shape. Line/Rectangular
Display Mode	<p>Sequential Draw the graph in the direction of movement.</p> <p>Pen Recorder Display a pen recorder type graph. Newest data is always on the right.</p> <p>[Direction]: RGT, [Display Mode]: Sequential      [Direction]: RGT, [Display Mode]: Pen Recorder</p> 
Direction	<p>Set the direction of graph lines.</p> <ul style="list-style-type: none"> <li>• RGT (right)</li> <li>• LFT (left)</li> <li>• UP (upward)</li> <li>• DW (downward)</li> </ul>  <p>Graph origin</p> <p>X: Time axis Y: Trend data</p>

## Reference line

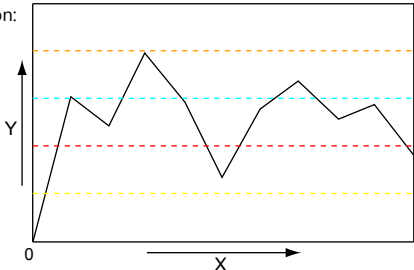
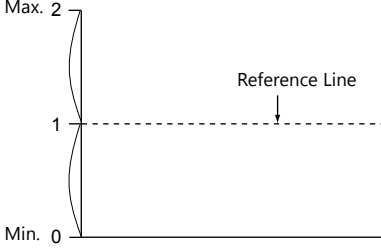
Item	Description
Reference Line 1 Reference Line 2 Reference Line 3 Reference Line 4	<p>A maximum of four reference lines can be displayed at once. The line type is fixed to a dotted line. <sup>*1</sup> The line color and the value where to display each reference line can be specified.</p> 
Min. Scale Value Max. Scale Value <sup>*2</sup>	<p>Set the scale values for calculating the position where the reference line should be drawn in the graph area. Negative values can also be specified.</p> <p>To draw a reference line in the center of a trend graph:</p> <p>Reference Line 1 - Min. Scale Value: 0 - Max. Scale Value: 2</p> <p>Specifying "1" for reference line 1 will display a line at the center.</p> 
Data Length	<p>Set a data length when specifying device memory (other than [Constant]) for reference lines or the minimum and maximum scale values. Set data length for the device memory. 1-Word/2-Word</p>
Input Type	Set the data type of the scale values. DEC-/BCD <sup>*3</sup> /FLOAT <sup>*4</sup>

<sup>\*1</sup> When device memory is specified for a [Reference Line], the reference line is updated at the [High Speed] process cycle setting. However, if the [Show/hide graph data] checkbox is selected in the [Detail] settings, updating is dependent on the specified process cycle.

\*2 When device memory is specified for the minimum and maximum scale values and the values in the device memory is changed in RUN mode, the change will be updated to the graph when the graph is displayed or when the "TREND\_REFRESH" macro command is executed.

For details on the "TREND\_REFRESH" macro command, refer to the V9 Series Macro Reference Manual.

\*3 When [DEC-/BCD] is selected, the setting at [System Setting] → [Hardware Setting] → [PLC Properties] → [Code] takes effect.

\*4 If any specified value (non-numeric inclusive) is outside the range usable on the V9 series unit, the line cannot be displayed.

For details on the allowable range, refer to "5.1.4 Real Numbers (Floating Point Numbers)".

## Data Acquisition

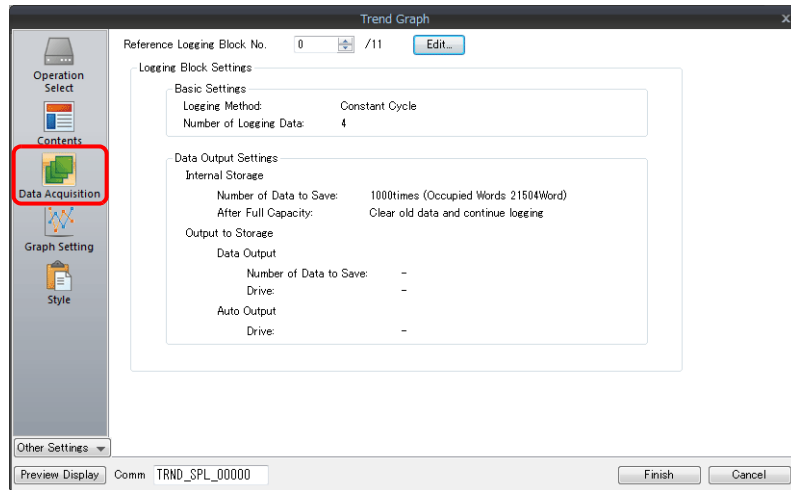

Item	Description
No.	Set the number registered to the logging server. The registration details are shown below.
Edit	Edit the logging server. For details, refer to "Detailed Settings" page 7-7.

## Graph Setting

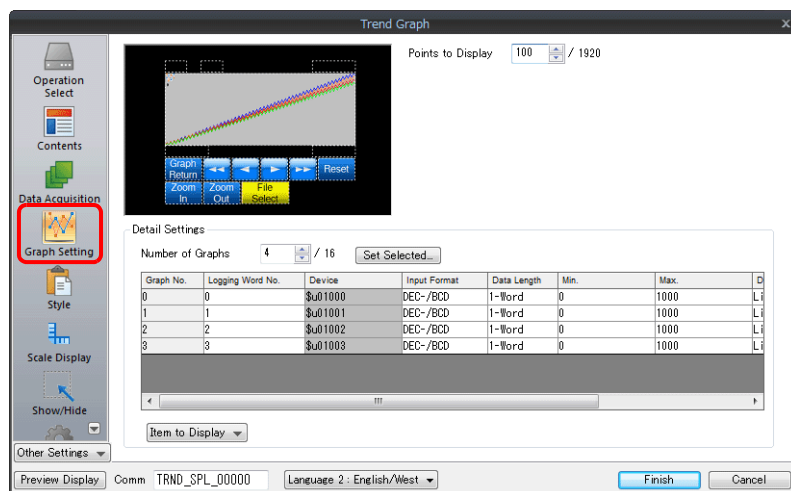

Item	Description
Points to Display *1	Set the number of plot points along the horizontal axis. <ul style="list-style-type: none"> <li>- For 1024 × 600 dots: 3 to 1024</li> <li>- For 800 × 600, 800 × 480 dots: 3 to 800</li> <li>- For 640 × 480 dots: 3 to 640</li> </ul>
Number of Graphs	Set the number of graph lines.
Set Selected	Use this button to configure settings for all displayed graph lines at once when the data length, data type, minimum value, and maximum value are all the same.

Item	Description
Logging Word No. *2	Specify which word the data corresponds to in the number of words specified for the logging server.
Device	Displays the logging device memory. The device memory can be changed in the settings of the logging server set in the [Data Acquisition] settings.
Input Format	Select the format for display on the screen. DEC-/BCD, Actual Number  DEC-/BCD This is determined by the setting at [System Setting] → [Hardware Setting] → [PLC Properties] → [Code].  Actual Number If any specified value (non-numeric inclusive) is outside the range usable on the V9 series unit, it cannot be displayed. For details on the allowable range, refer to "5.1.4 Real Numbers (Floating Point Numbers)".
Data Length	Set data length for the device memory. 1-Word/2-Word
Max., Min. *3	Set the minimum and maximum values of the graph.  * An error will occur if the same value is set. Make sure to set valid values.
Display Format	Set the graph type. Line Graph/Marker
Type	Set the line type.
Color	Set the line color.

\*1 Number of display points

Direction: RGT

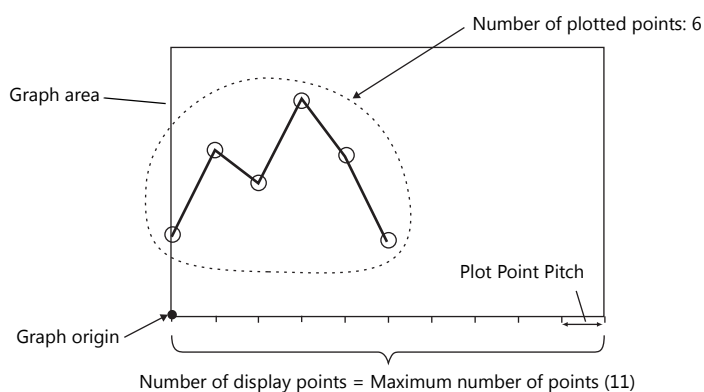

If a value larger than the X size (dots) of the graph area is specified for [Points to Display], the graph will not be drawn correctly.

\*2 Example: 8 words set for the logging server

To display the logging data of the 3rd word in the logging server, specify "2" for [Logging Word No.].  
Even if [Data Length] is different, the corresponding device memory is the same.

[Data Length]: 1-Word		[Data Length]: 2-Word	
	Logging Word No.		Logging Word No.
1st word	0	1st word	0
2nd word	1	2nd word	2
3rd word	2	3rd word	4
4th word	3	4th word	6
5th word	4	5th word	
6th word	5	6th word	
7th word	6	7th word	
8th word	7	8th word	

\*3 When device memory is specified for the minimum and maximum graph values and the values at the device memory are changed in RUN mode, the changes will be updated to the graph when the graph is displayed or when the "TREND\_REFRESH" macro command is executed.



For details on the "TREND\_REFRESH" macro command, refer to the V9 Series Macro Reference Manual.



## Style

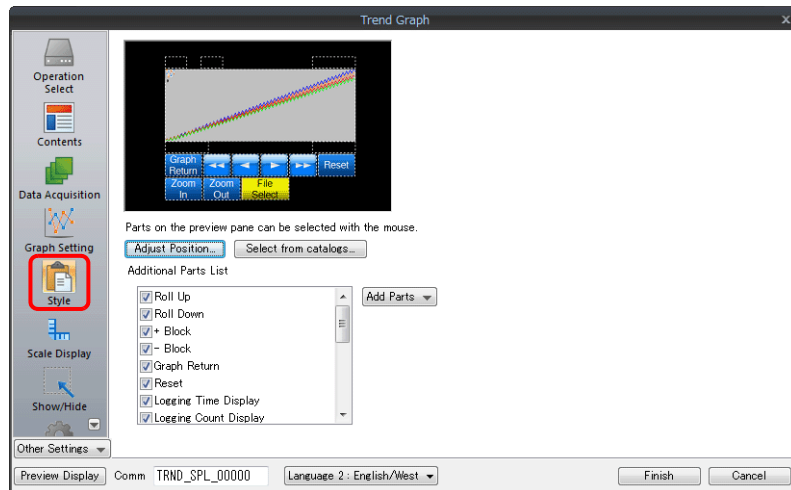

Item	Description
Adjust Position	Change the layout of parts.
Select from catalogs	Change the trend sampling parts.
Add Parts	Add new parts. New parts are added to the [Addition Parts List].

- The additional parts are listed below.

Function	Description
Roll Up	Move the cursor to the next point.
Roll Down	Move the cursor to the previous point.
+ Block	Display the next page.
- Block	Display the previous page.
Graph Return	Blinks while the cursor is displayed when a switch such as [+ Block] or [- Block] is pressed. Press this switch when it is blinking to stop it from blinking and return to the latest display.
Reset	Press this switch once to activate it and press it again within 2 seconds to clear the graph. After the graph is cleared, logging is resumed. If not pressed again within 2 seconds, the switch is turned off and resetting is nullified.
Logging Time Display *1	Display the last logging time or selected logging time.
Logging Count Display	Display the current history number or the count value of the selected history data.
Zooming in	Enlarge the display magnification of the currently displayed graph in order from actual size → 2 times → 4 times → 8 times.
Zooming out	Reduce the display magnification of the currently displayed graph in order from 8 times → 4 times → 2 times → actual size.
Display start time *1	Display the logging time of the oldest history data on the currently displayed graph.
Display end time *1	Display the logging time of the newest history data on the currently displayed graph.
Currently Selected Value Display *1	Display the latest history data or the selected history data.
File Select	Select and display a backup file saved to a storage device.
Mean Value Display	Display the average value of the history data of each graph.
Total Display	Display the total value of the history data of each graph.
Max. Display	Display the maximum value of the history data of each graph.
Min. Display	Display the minimum value of the history data of each graph.

\*1 Up to the year, month, and day can be displayed if enough digits are specified.

Less than 8 digits	No display
8 to 11 digits	Hour, minutes, and seconds
12 to 17 digits	Hour, minutes, seconds, and milliseconds
18 to 22 digits	Month, day, hour, minutes, seconds, and milliseconds
23 digits or more	Year, month, day, hour, minutes, seconds, and milliseconds

\*2 Only for monitoring. To store these values in device memory, use the "SAMPLE" macro command.

For details, refer to the V9 Series Macro Reference Manual.

## Scale Display

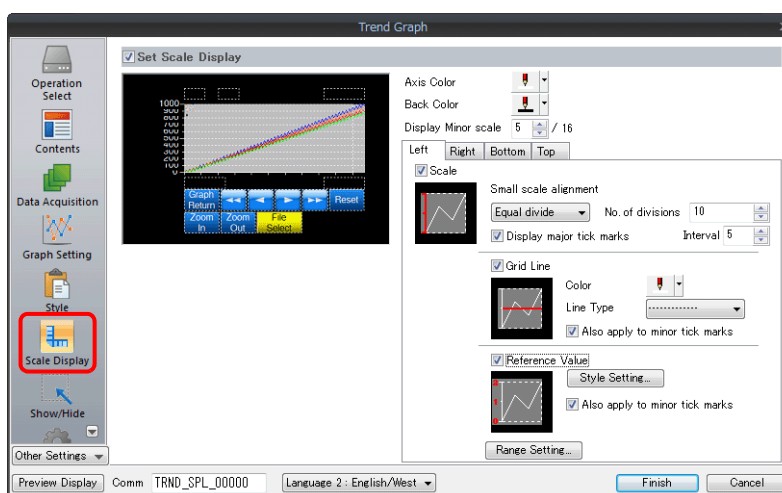

Item	Description													
Axis Color	Select the color of the major and minor tick marks, and axis lines of the scale.													
Back Color	This setting is common to all left, right, bottom, and top sides.													
Display Minor scale	Set the length of the minor tick marks of the scale. Range: 1 to 16 This setting is common to all left, right, bottom, and top sides. The thickness of the markings is fixed.													
[Scale] in [Left], [Right], [Bottom], and [Top] tab windows	Displays the scale, grid line, and reference value settings for each side. Default: Selected on [Left] and [Bottom] tab windows													
Small scale alignment	<p>Equal divide (unit based on [No. of divisions]) Minor tick marks are equally spaced according to the specified number of divisions along the axis line.</p> <p>Equal interval (unit based on [Interval]) Minor tick marks are equally spaced according to the specified interval from the zero point along the axis line within the following range.</p> <table border="1" data-bbox="660 1122 1343 1294"> <thead> <tr> <th>Graph Direction</th> <th>Side</th> <th>Range</th> </tr> </thead> <tbody> <tr> <td>LFT/RGT</td> <td>Top/Bottom</td> <td rowspan="2">Number of horizontal axis points or scale of [Range Setting]</td> </tr> <tr> <td>DW/UP</td> <td>Left/Right</td> </tr> <tr> <td>LFT/RGT</td> <td>Left/Right</td> <td rowspan="2">Scale of [Range Setting]</td> </tr> <tr> <td>DW/UP</td> <td>Top/Bottom</td> </tr> </tbody> </table>	Graph Direction	Side	Range	LFT/RGT	Top/Bottom	Number of horizontal axis points or scale of [Range Setting]	DW/UP	Left/Right	LFT/RGT	Left/Right	Scale of [Range Setting]	DW/UP	Top/Bottom
Graph Direction	Side	Range												
LFT/RGT	Top/Bottom	Number of horizontal axis points or scale of [Range Setting]												
DW/UP	Left/Right													
LFT/RGT	Left/Right	Scale of [Range Setting]												
DW/UP	Top/Bottom													
Display major tick marks	Display major tick marks on the scale. (Unit: [Interval]) Length: Twice the minor tick marks Thickness: Fixed													
Grid Line	Grid lines are drawn at the major and minor tick marks of the scale.													
Color, Line Type	Set the color and line type of grid lines.													
Also apply to minor tick marks	This can be set when the [Display major tick marks] checkbox is selected. Set whether to display grid lines. Selected: Display at both major and minor tick marks Unselected: Only display at major tick marks													
Reference Value	Select this checkbox to display reference values at major and minor tick marks on the scale.													
Property	Set the number of digits or the color of reference values shown at tick marks.													
Also apply to minor tick marks	This can be set when the [Display major tick marks] checkbox is selected. Set whether to display reference values. Selected: Display at both major and minor tick marks Unselected: Only display at major tick marks													
Range Setting	<p>Use when [Small scale alignment] is set to [Equal divide] or when the [Reference Value] checkbox is selected.</p> <p>Match with the specified graph The range changes according to the following combinations.</p> <table border="1" data-bbox="660 1767 1343 1939"> <thead> <tr> <th>Graph Direction</th> <th>Side</th> <th>Range</th> </tr> </thead> <tbody> <tr> <td>LFT/RGT</td> <td>Top/Bottom</td> <td rowspan="2">Number of horizontal axis points</td> </tr> <tr> <td>DW/UP</td> <td>Left/Right</td> </tr> <tr> <td>LFT/RGT</td> <td>Left/Right</td> <td rowspan="2">Maximum and minimum values specified for the selected graph number *</td> </tr> <tr> <td>DW/UP</td> <td>Top/Bottom</td> </tr> </tbody> </table> <p>Set Value Specify the minimum and maximum values using constants or device memory addresses. *</p>	Graph Direction	Side	Range	LFT/RGT	Top/Bottom	Number of horizontal axis points	DW/UP	Left/Right	LFT/RGT	Left/Right	Maximum and minimum values specified for the selected graph number *	DW/UP	Top/Bottom
Graph Direction	Side	Range												
LFT/RGT	Top/Bottom	Number of horizontal axis points												
DW/UP	Left/Right													
LFT/RGT	Left/Right	Maximum and minimum values specified for the selected graph number *												
DW/UP	Top/Bottom													

\* If the minimum and maximum values are specified with device memory addresses (other than [Constant]) in the [Range Setting] window and these values are changed in RUN mode, the changes are updated at the following timings:

- When the screen is redrawn
- Upon execution of the "TREND\_REFRESH" macro command

## Detail

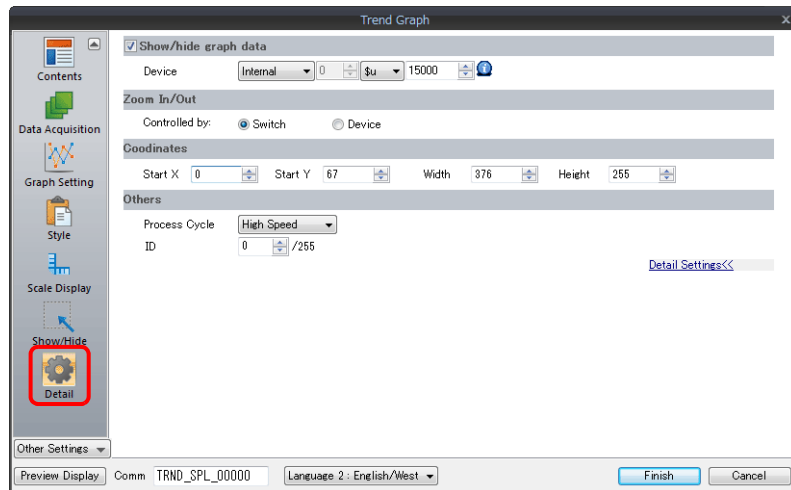

Item	Description
Show/hide graph data	Set the device memory used to show/hide graph line numbers 0 to 15. *
Device (word designation)	<p>These bits control whether each graph is shown or hidden.</p> <p>MSB 15 .. .. . 04 03 02 01 00 LSB</p> <p>Graph number 15      Graph number 3      Graph number 2      Graph number 1      Graph number 0</p> <p>1: Show 0: Hide</p>
Process Cycle	Set the cycle used to read the device memory. High Speed, Low Speed, Refresh
Zoom In/Out	<p>Set the method for enlarging and reducing graphs.</p> <p>Switch Zoom in: actual size → 2 times → 4 times → 8 times Zoom out: 8 times → 4 times → 2 times → actual size</p> <p>Device The graph will be zoomed in to a magnification of the following. 0: Actual size 1: 2 times 2: 4 times 3: 8 times</p>
Coordinates	Select a display position and size.
ID	Set an ID number.

\* Notes on the [Show/hide graph data] setting

- This is counted as one of the number of device memory locations that is permitted for one screen.



For details on the number of permissible device memory locations, refer to the V9 Series Operation Manual.

- Even if all the graph lines are hidden, the switches for [Roll Up], [Roll Down], [+ Block], [- Block] and [Graph Return] still work. The moved cursor point is also retained. (But the cursor is hidden.)
- When graph lines are shown or hidden, flickering associated with graph redrawing will occur momentarily.

## Notes

### Relationship Between Area and Plot Points

The V9 series automatically calculates the plot point pitches for drawing graph lines as follows:

$$\text{Formula: Point pitch (dots)} = \text{X size (dots)} \div ([\text{Points to Display}] - 1)$$

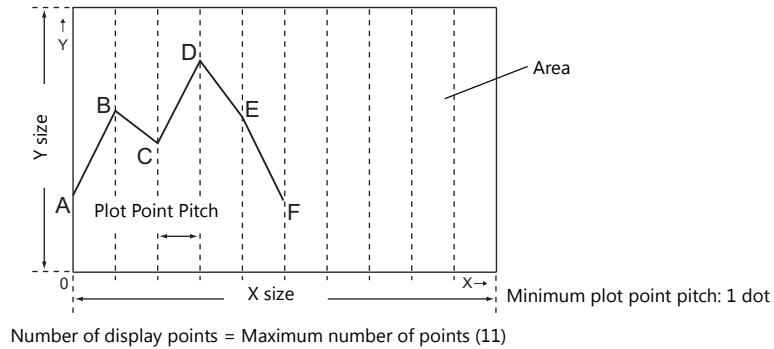

Example: X size: 270 (dots), [Points to Display]: 10

$$270 \div (10 - 1) = 30$$

The plot point pitch is "30".



When adjusting the size of an area after setting [Points to Display], it is automatically enlarged or reduced so that there will be no remainder left.

However, if the value for [Points to Display] is changed after the part is placed and adjusted in size, a remainder may result. The remainder dots will be shown as a blank area.

Example: X size: 278 (dots), [Points to Display]: 50

$$278 \div (50 - 1) = 5, \text{ remainder } 33$$

The plot point pitch is 5 dots and the remainder (33 dots) becomes a blank area.

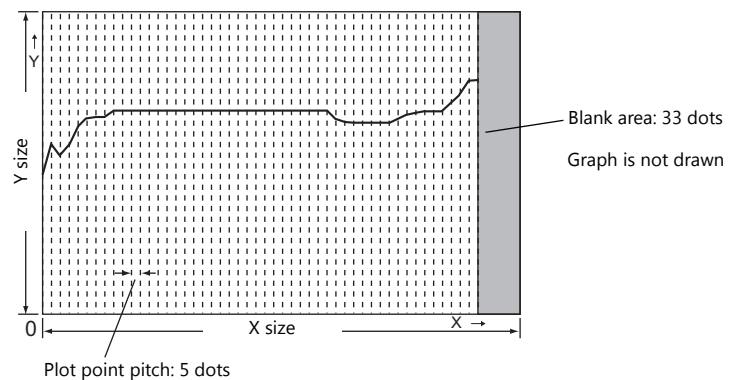

After setting the number of points for display, correct the X size of the display area to eliminate the blank area.

## 7.2.3 Data Display

- History data saved to a logging server can be displayed as numerical data or character data.
- A maximum of 16 entries of data can be displayed in a single display area.



- Backup files output to a storage device can be selected for display.

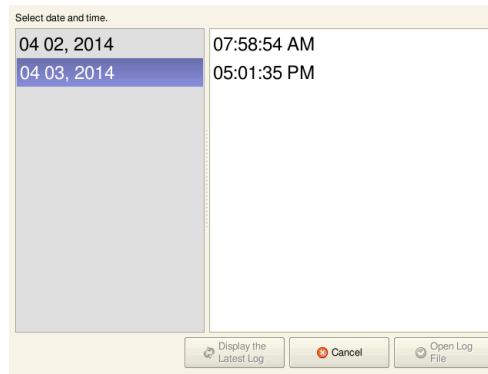

- History data saved to a logging server can be printed (log printing).

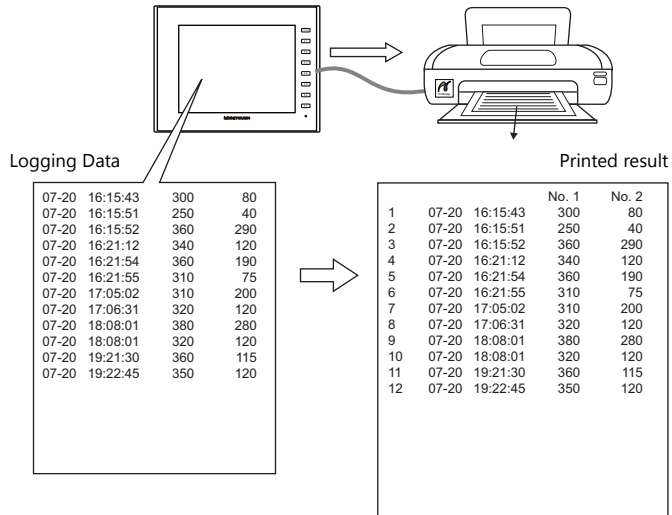

## Location of Setting

Click [Parts] → [Trend] and place a graph on the screen.



## Detailed Settings

### Operation Select

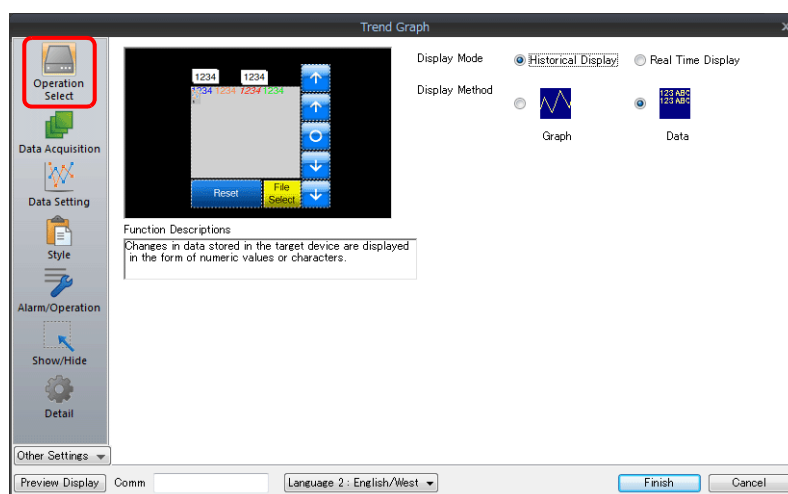

Item	Description
Display Mode	Select [Historical Display].
Display Method	Select [Data].

### Data Acquisition

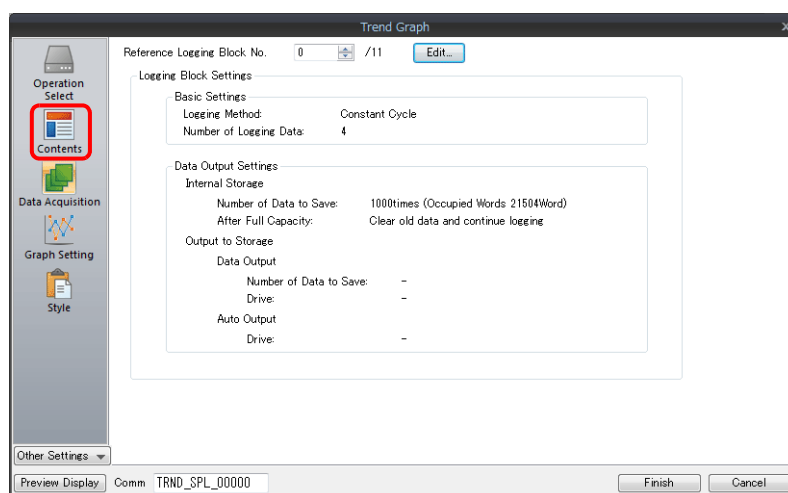

Item	Description
No.	Set the number registered to the logging server. The registration details are shown below.
Edit	Edit the logging server. For details, refer to "Detailed Settings" page 7-7.

## Data Setting

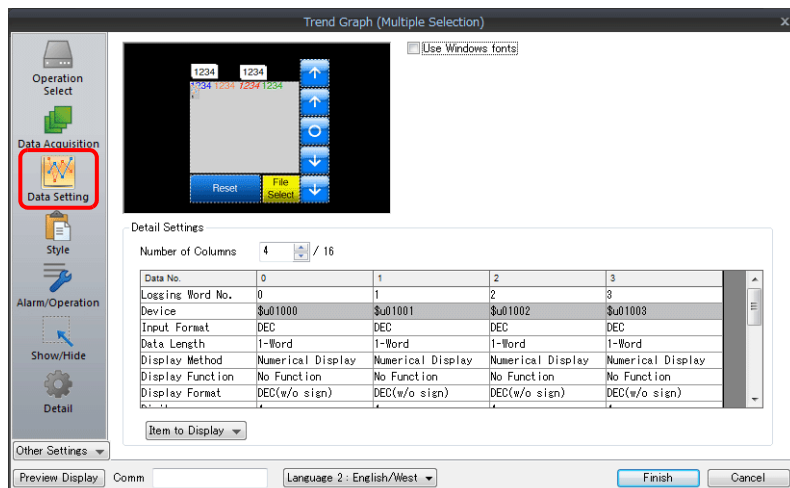

Item	Description																					
Use Windows fonts	Display history data using a Windows font. Register all text to display via [Windows Font Registration].																					
Number of Columns	Set the number of data entries to display.																					
Logging Word No. *1	Specify which word the data corresponds to in the number of words specified for the logging server.																					
Device	Displays the logging device memory. The device memory can be changed in the settings of the logging server set in the [Data Acquisition] settings.																					
Input Format	Select the code type to use when reading data from the PLC device. The selection here also applies to [Alarm], [Operation], and [Scaling]. DEC/BCD/Actual Number *2																					
Data Length	Set the data length. <table border="1" style="margin-left: 20px;"> <thead> <tr> <th>Code Format</th> <th>1-word Display Range</th> <th>2-word Display Range</th> </tr> </thead> <tbody> <tr> <td>DEC (w/o sign)</td> <td>0 - 65535</td> <td>0 - 4294967295</td> </tr> <tr> <td>DEC (with sign -)</td> <td>-32768 - 32767</td> <td>-2147483648 - 2147483647</td> </tr> <tr> <td>DEC (with sign +-)</td> <td>-32768 - +32767</td> <td>-2147483648 - +2147483647</td> </tr> <tr> <td>HEX</td> <td>0 - FFFF</td> <td>0 - FFFFFFFF</td> </tr> <tr> <td>OCT</td> <td>0 - 177777</td> <td>0 - 3777777777</td> </tr> <tr> <td>BIN</td> <td>0 - 1111111111111111</td> <td>0 - 11111111111111111111111111111111</td> </tr> </tbody> </table>	Code Format	1-word Display Range	2-word Display Range	DEC (w/o sign)	0 - 65535	0 - 4294967295	DEC (with sign -)	-32768 - 32767	-2147483648 - 2147483647	DEC (with sign +-)	-32768 - +32767	-2147483648 - +2147483647	HEX	0 - FFFF	0 - FFFFFFFF	OCT	0 - 177777	0 - 3777777777	BIN	0 - 1111111111111111	0 - 11111111111111111111111111111111
Code Format	1-word Display Range	2-word Display Range																				
DEC (w/o sign)	0 - 65535	0 - 4294967295																				
DEC (with sign -)	-32768 - 32767	-2147483648 - 2147483647																				
DEC (with sign +-)	-32768 - +32767	-2147483648 - +2147483647																				
HEX	0 - FFFF	0 - FFFFFFFF																				
OCT	0 - 177777	0 - 3777777777																				
BIN	0 - 1111111111111111	0 - 11111111111111111111111111111111																				
Display Method	Select the data display method. Numerical Display/Char. Display																					
Display Function	No function Display the logged data.  Logging No. Display This display type is compatible with earlier MONITOUCH models. For details, refer to the File Conversion manual.																					
Display Format	Select the format for display on the screen.  DEC (w/o sign), DEC (with sign -), DEC (with sign +-), HEX, OCT, BIN (Binary)																					
Digits *3	Set the number of digits for numerical data display. <table border="1" style="margin-left: 20px;"> <thead> <tr> <th>Display Format</th> <th>Digits</th> <th>Decimal Point</th> </tr> </thead> <tbody> <tr> <td>DEC</td> <td>1 - 10</td> <td>0 - 9</td> </tr> <tr> <td>HEX</td> <td>1 - 8</td> <td>-</td> </tr> <tr> <td>OCT</td> <td>1 - 11</td> <td>-</td> </tr> <tr> <td>BIN</td> <td>1 - 32</td> <td>-</td> </tr> </tbody> </table>	Display Format	Digits	Decimal Point	DEC	1 - 10	0 - 9	HEX	1 - 8	-	OCT	1 - 11	-	BIN	1 - 32	-						
Display Format	Digits	Decimal Point																				
DEC	1 - 10	0 - 9																				
HEX	1 - 8	-																				
OCT	1 - 11	-																				
BIN	1 - 32	-																				
Decimal Point	Set the number of decimal places. When no decimal point is required, set "0".																					
Char. Color	Set the text properties.																					
Back Color																						
Bold																						
Shadow																						
1/4																						
Italic																						
Transparent																						
Character Size																						

Item	Description
Zero Suppress	Set the display method for numerical values that do not satisfy the specified digits condition. Selected: Do not display zeros in front of the value Unselected: Display zeros in front of the value
Char. Place	Select either flush-left or flush-right for character display.
Text Process	Set the order of the first and second bytes in words.

\*1 Example: 8 words set for the logging server

To display the logging data of the 3rd word in the logging server, specify "2" for [Logging Word No.]. Even if [Data Length] is different, the corresponding device memory is the same.

[Data Length]: 1-Word		[Data Length]: 2-Word	
	Logging Word No.		Logging Word No.
1st word	0	1st word	0
2nd word	1	2nd word	
3rd word	2	3rd word	2
4th word	3	4th word	
5th word	4	5th word	4
6th word	5	6th word	
7th word	6	7th word	6
8th word	7	8th word	

\*2 If any value (non-numeric inclusive) specified is outside the range usable on MONITOUCH, the value cannot be displayed.

 For details on the allowable range, refer to "5.1.4 Real Numbers (Floating Point Numbers)".

\*3 Values entered that exceed the set number of digits are displayed as shown in the following table.

Display Format	DEC	HEX/OCT/BIN
Display	Overflow display	Numbers from the right
[Data Length]: 1-Word [Digits]: 3 Entered value: 1010	---	010

## Style

Same as graph history display.

 For details, refer to "Style" page 7-20.



## Alarm/Operation

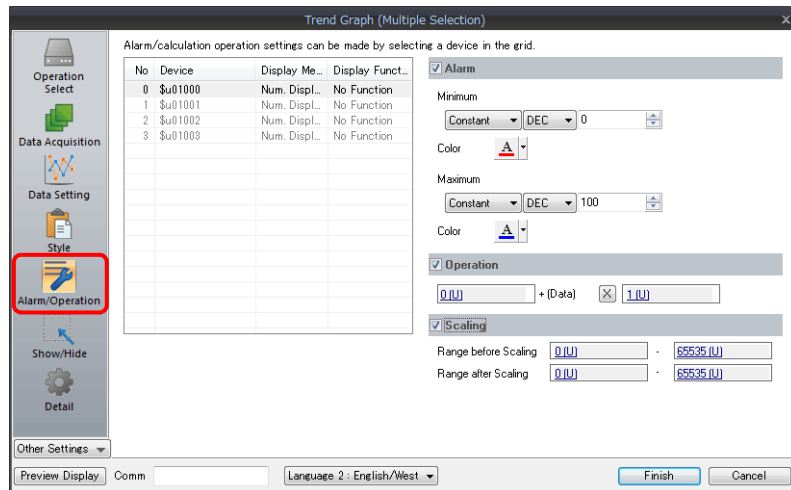

Item	Description
Alarm	If a value is outside the range of the maximum and minimum values, the color for display can be changed.
Operation	Perform an operation on the value of the device memory.
Scaling	Data (Range before Scaling) that the PLC has read is converted into the set range (Range after Scaling) that is set.

## Detail

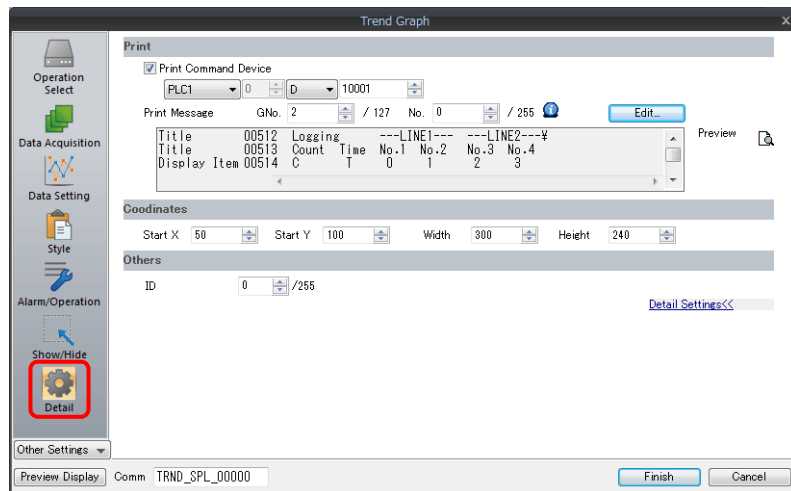

Item	Description																																
Print Command Device	Print the logged data. Set one word. <table border="1" style="margin-left: 40px;"> <tr> <td>15</td><td>14</td><td>13</td><td>12</td><td>11</td><td>10</td><td>09</td><td>08</td><td>07</td><td>06</td><td>05</td><td>04</td><td>03</td><td>02</td><td>01</td><td>00</td> </tr> <tr> <td></td><td>0</td><td>0</td><td>0</td><td>0</td><td>0</td><td>0</td><td>0</td><td>0</td><td>0</td><td>0</td><td>0</td><td>0</td><td>0</td><td>0</td><td>0</td> </tr> </table> <p style="margin-left: 40px;">Not used (always set to "0")</p> <p style="margin-left: 40px;">0 → 1: Execute</p>	15	14	13	12	11	10	09	08	07	06	05	04	03	02	01	00		0	0	0	0	0	0	0	0	0	0	0	0	0	0	0
15	14	13	12	11	10	09	08	07	06	05	04	03	02	01	00																		
	0	0	0	0	0	0	0	0	0	0	0	0	0	0	0																		
Print Message	Specify the top number of the message registered with the layout and titles (text) for printing. Click [Edit] to display the [Message Edit] window. For details, refer to "Log Printing" page 7-29.																																
Preview	Check a preview of the data for printing.																																
Coordinates	Set the coordinates.																																
ID	Set an ID number.																																

## Log Printing

### Overview

History data saved to a logging server can be printed.

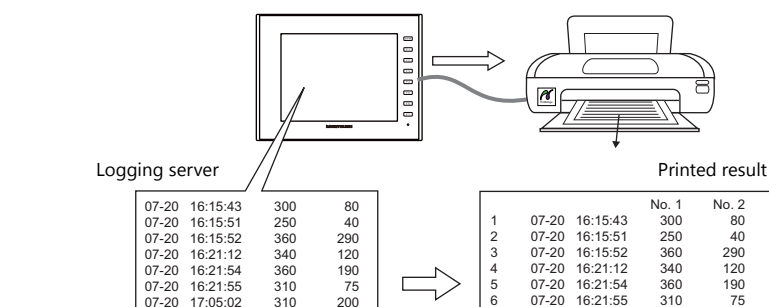

For details on printing, such as printer compatibility and print setting procedures, refer to "16 Print".

## Registering Print Messages

### Location of registration

[Trend Graph] settings window → [Detail] → [Print Message]

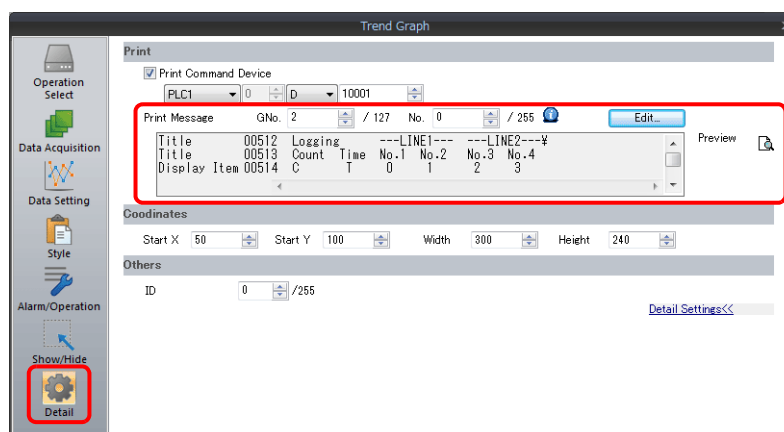

### Registration details

- The top line in the specified print message contains the title for printing.  
To use two or more lines for titles, insert a one-byte "\" character at the end of the line. The next line will be recognized as a part of the title. Note that the "\" on the end of the line is not printed.
- On the line following the titles, specify the positions to indicate count, time, and logging data.  
Use one-byte characters "C", "T", and "0" to "15".

C: Sampling count print position  
T: Sampling time print position  
0 - 15: Print positions of data numbers 0 to 15

Alignment of C, T and 0 to 15 depends on the formats set for [Logging Count Display], [Logging Time Display] and [Trend] parts place on the screen.

- If [Zero Suppress] and [Flush Right] are selected for these parts, the values are printed with the lowest digit in alignment. If [Zero Suppress] and [Flush Left] are selected for these parts, the values are printed with the highest digit in alignment. If [Zero Suppress] is not checked, the values are printed without zero suppression.

[Zero Suppress] checked [Flush Left]	C	T	0	1
	↓	↓	↓	↓
	0	0	12345	12345

- The registered message is printed as the header at the top of each page.



Even when "C" (count) and "T" (time) are registered in the print message, the count and time are not printed if [Logging Count Display] and [Logging Time Display] parts are not placed on a screen.

## Registration example

[Print Message] Message GNo. 2 : No. 0  
 [Zero Suppress] unselected  
 [Flush Left]

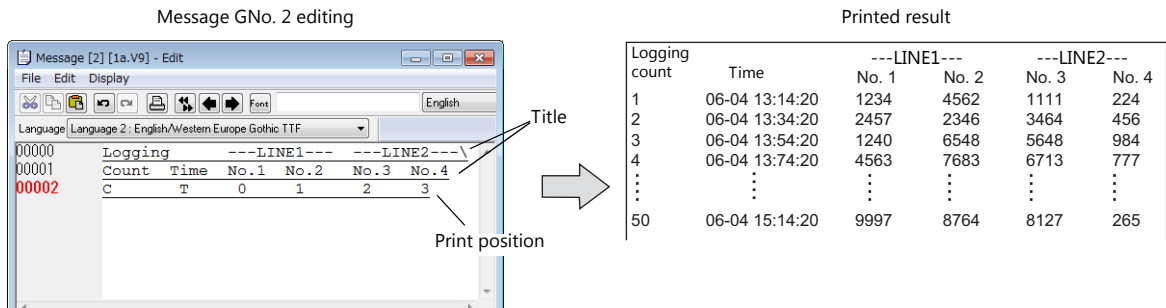

## Execution Method

There are two methods for printing logging data.

- Switch function: [Logging] → [Print]

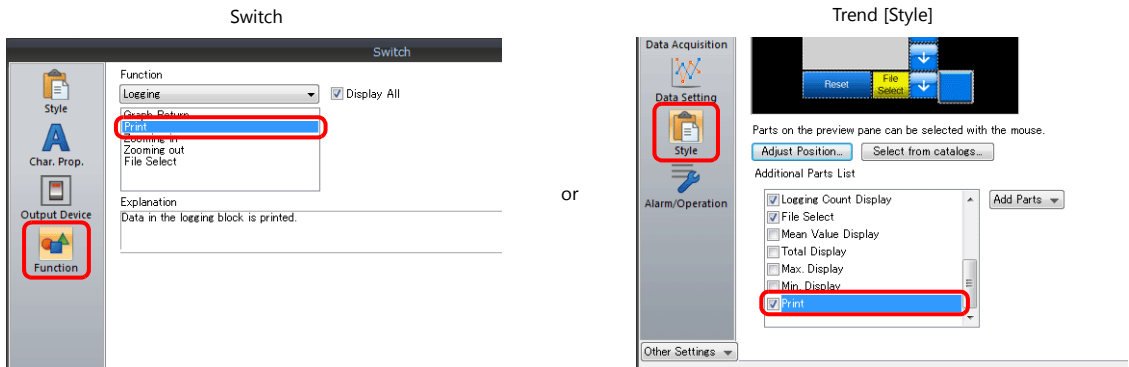

- Print Command Device

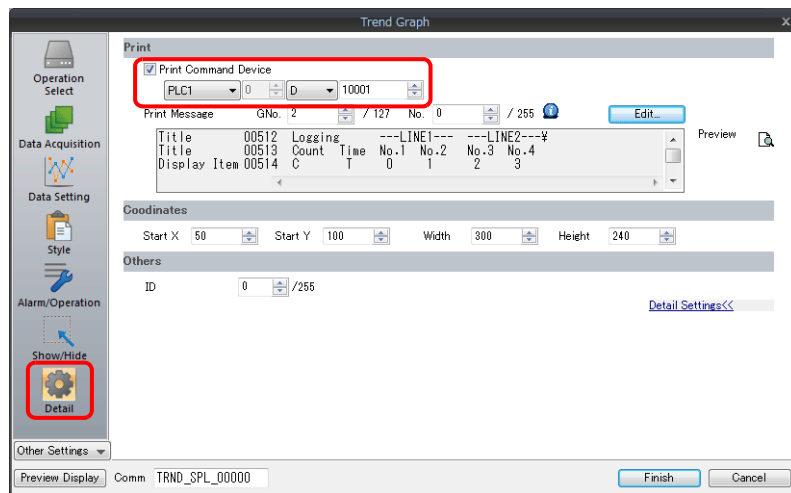

Item	Description
Print Command Device	Print the logged data. Set one word.

15	14	13	12	11	10	09	08	07	06	05	04	03	02	01	00
0	0	0	0	0	0	0	0	0	0	0	0	0	0	0	0

Not used (always set to "0")

0 → 1: Execute

## 7.3 Real Time Display

- Values in consecutive device memory addresses can be expressed on a line graph. Subsidiary lines can be drawn for easier recognition of data changes.

Example: Graph display of data in addresses D100 to D110

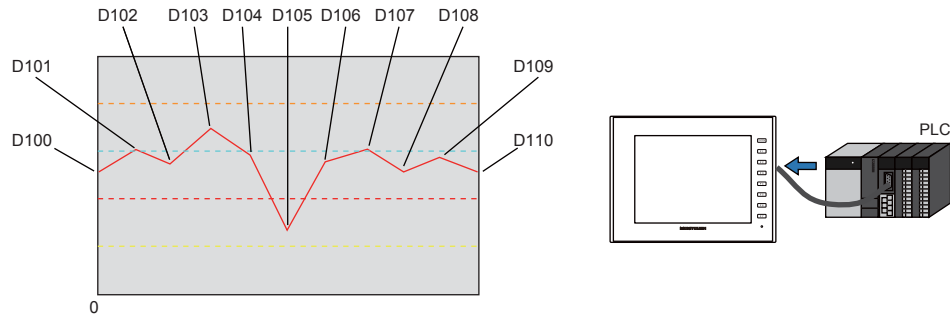

☞ Refer to ["7.3.1 Location of Settings"](#) page 7-32.

☞ Refer to ["7.3.4 Display Method"](#) page 7-42.

- A maximum of 16 trends (lines) can be displayed.
- Negative values can also be displayed on graphs.
- The interval between each point (point pitch) can be changed between equal pitch or an arbitrary pitch.

Example: When specifying the number of dots or the scale

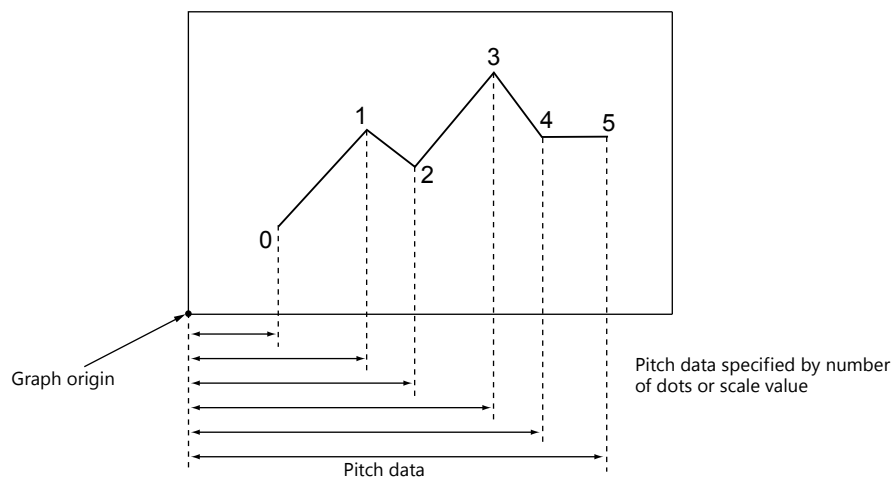

☞ For details, refer to ["Plot Point Pitch"](#) page 7-38.

- Parent/child trends (overlay)  
Asynchronous graphs can be displayed in the same graph area.

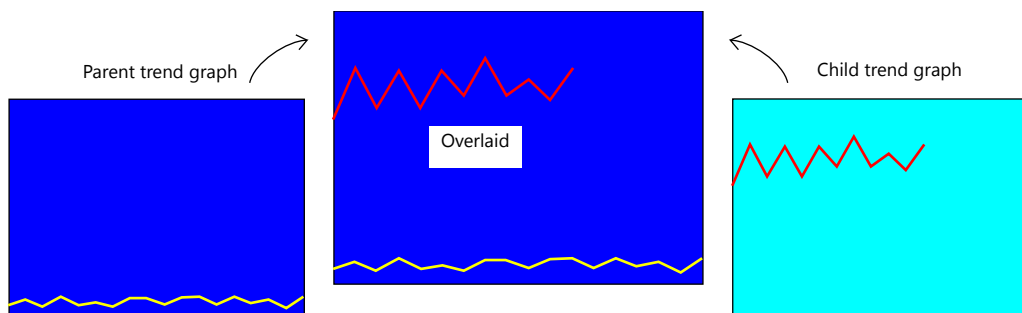

☞ For details, refer to ["Asynchronous Display of Multiple Trend Graphs"](#) page 7-43.

### 7.3.1 Location of Settings

Click [Parts] → [Trend] and place a graph on the screen.



For details on the display method, refer to "7.3.4 Display Method" page 7-42.

### 7.3.2 Detailed Settings

#### Operation Select

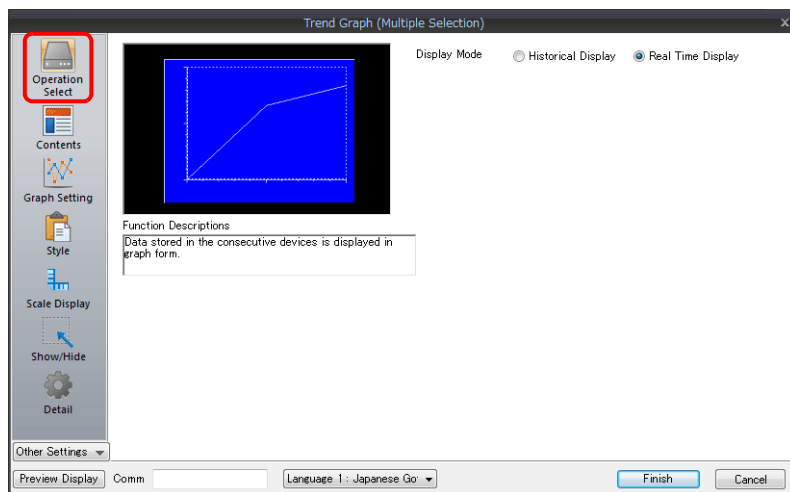

Item	Description
Display Mode	Select [Real Time Display].

#### Contents

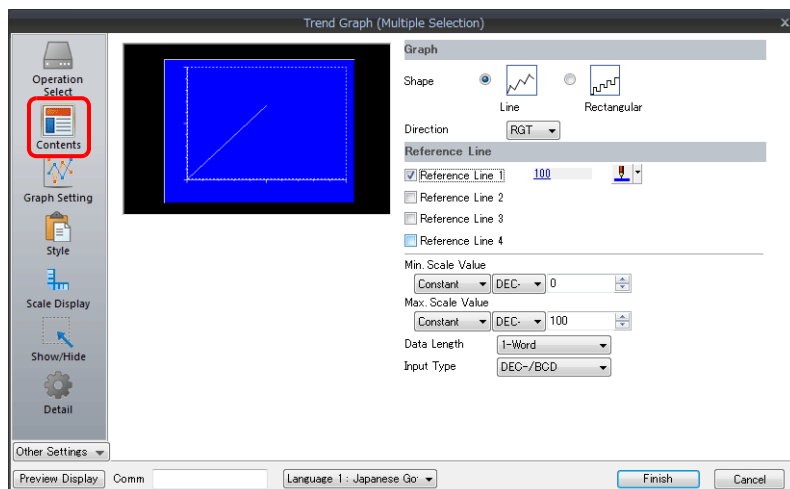

## Graph

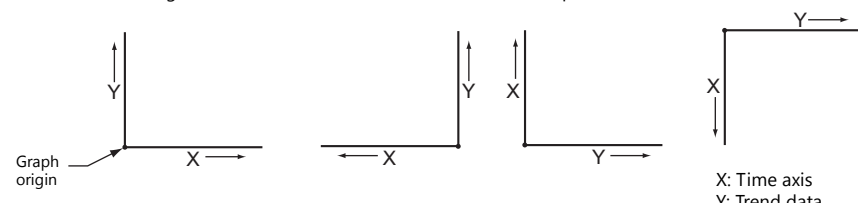
Item	Description
Shape	Set the graph shape. Line/Rectangular
Direction	Set the direction of graph lines. <ul style="list-style-type: none"> <li>• RGT (right)</li> <li>• LFT (left)</li> <li>• UP (upward)</li> <li>• DW (downward)</li> </ul> 

## Reference line

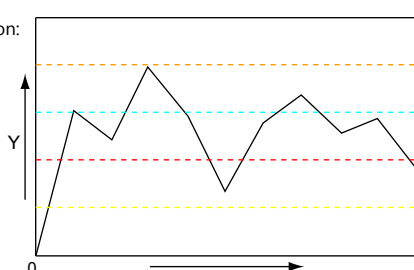
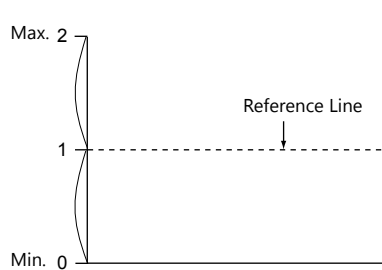
Item	Description
Reference Line	Display a maximum of four horizontal reference lines on a graph. Set the display position and color of each reference line. The line type is fixed to a dotted line.  <p>X: Time axis Y: Trend data</p> <p>When a device memory address (other than [Constant]) is set, reference lines are updated when the graph is displayed or when a "redraw" or a "redraw after clear" is commanded by the control device memory.</p>
Min. Scale Value Max. Scale Value *2	Set the scale values for calculating the position where the reference line should be drawn in the graph area. Negative values can also be specified. <p>To draw a reference line in the center of a trend graph:</p> <p>Reference Line 1</p> <ul style="list-style-type: none"> <li>- Min. Scale Value: 0</li> <li>- Max. Scale Value: 2</li> </ul> <p>Specifying "1" for reference line 1 will display a line at the center.</p> 
Data Length	Set a data length when specifying device memory (other than [Constant]) for reference lines or the minimum and maximum scale values. Set data length for the device memory. 1-Word/2-Word
Input Type	Set the data type of the scale values. DEC-/BCD *1/FLOAT *2

\*1 When [DEC-/BCD] is selected, the setting at [System Setting] → [Hardware Setting] → [PLC Properties] → [Code] takes effect.

\*2 If any specified value (non-numeric inclusive) is outside the range usable on the V9 series unit, the line cannot be displayed.

 For details on the allowable range, refer to "5.1.4 Real Numbers (Floating Point Numbers)".

## Graph Setting

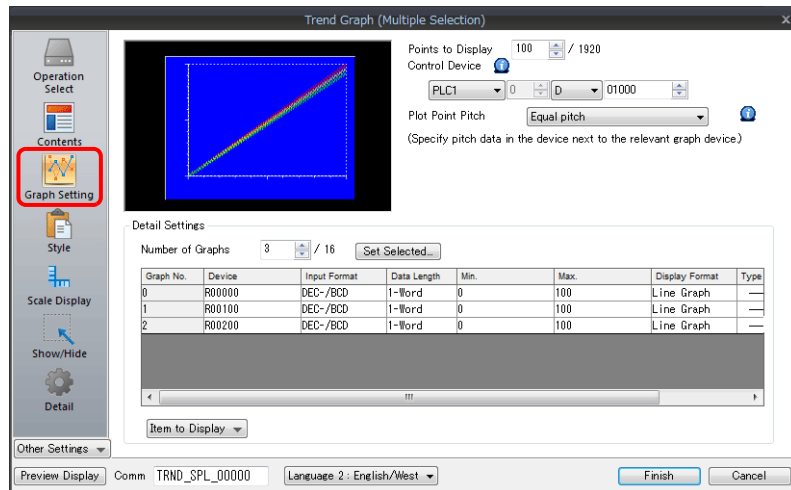

Item	Description																																
Points to Display <sup>*1</sup>	Set the number of plot points along the horizontal axis. - 640 × 480 dots: 3 to 640 - 800 × 600 dots: 3 to 800																																
Control Device	<table border="1" data-bbox="635 896 1289 963"> <tr> <td>15</td><td>14</td><td>13</td><td>12</td><td>11</td><td>10</td><td>09</td><td>08</td><td>07</td><td>06</td><td>05</td><td>04</td><td>03</td><td>02</td><td>01</td><td>00</td> </tr> <tr> <td></td><td></td><td>0</td><td>0</td><td>0</td><td></td><td></td><td></td><td></td><td></td><td></td><td></td><td></td><td></td><td></td><td></td> </tr> </table> <p>                     0 → 1: Redraw                      0 → 1: Redraw after clear                      Points to Display                 </p> <p>Number of plotted points <sup>*1</sup>: 0 to 1024</p> <p>Set the number of points to display. The content of the device memory addresses set for numbers 0 to 15 is read for the specified number of points.</p> <p>Redraw <sup>*2</sup></p> <p>The number of points to display are redrawn. 0 → 1 Drawing is performed over the previous graph without clearing the graph area. The previously displayed image remains.</p> <p>Redraw after clear <sup>*2</sup></p> <p>The number of points to display are redrawn. 0 → 1 Drawing is performed after clearing the graph area. Only the latest graph is displayed.</p>	15	14	13	12	11	10	09	08	07	06	05	04	03	02	01	00			0	0	0											
15	14	13	12	11	10	09	08	07	06	05	04	03	02	01	00																		
		0	0	0																													
Plot Point Pitch	Equal pitch Space all points equally.  Specify the scale range Specify the interval between points using the scale range.  Specify the number of dots Specify the interval between points with the number of dots.  For details, refer to "7.3.3 Plot Point Pitch" page 7-38.																																
Detailed Settings	Number of Graphs	Set the number of graph lines. Max. 16																															
	Device	The contents of this device memory address is read and displayed on the graph. The required number of addresses varies depending on the setting for [Points to Display] and [Data Length]. For details, refer to "7.3.3 Plot Point Pitch" page 7-38.																															
	Use Range	Point pitch: when specified with the number of dots																															
	Input Format	Set data format of device memory values. DEC- / BCD <sup>*3</sup> / Actual Number <sup>*4</sup> The selection here also applies to minimum, maximum, and X axis scale values.																															
	Data Length	Select the data length for one plot point. 1-Word/2-Word																															
	Min. <sup>*5</sup>	Set the graph display area. (PLC device memory <sup>*6</sup> / internal device memory <sup>*6</sup> / constant)																															
	Max. <sup>*5</sup>																																
	Min. Scale <sup>*5</sup>	Set when [Graph Setting] → [Plot Point Pitch] is set to [Specify the scale range]. For details, refer to "7.3.3 Plot Point Pitch" page 7-38.																															
	Max. Scale <sup>*5</sup>																																
	Display Format	Set the graph type (line or marker) and color.																															
Type																																	
Color																																	

Item	Description
Item to Display	Change the items displayed in the [Detail Settings] area.

## \*1 Number of display points

Direction: RGT

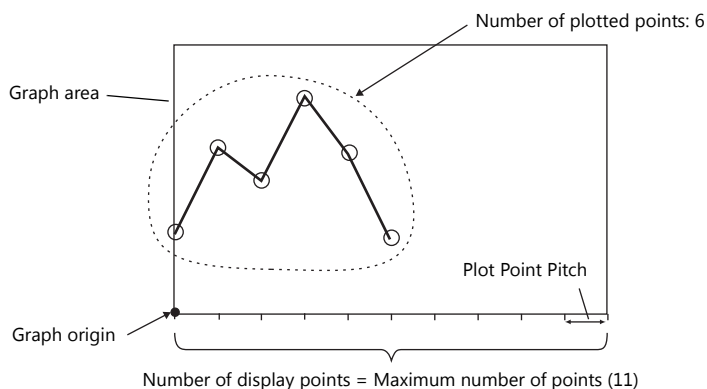

If a value larger than the X size (dots) of the graph area is specified for [Points to Display], the graph will not be drawn correctly.

## \*2 "Redraw" and "redraw after clear"

When redrawing, select the "Redraw" or "Redraw after clear" bit.  
If the interval between redrawing is too short, the graph may not be redrawn even at the leading edge.  
Once displayed, data on the graph cannot be changed unless the redrawing command is given.

## \*3 When [DEC-/BCD] is selected, the setting for [System Setting] → [Hardware Setting] → [PLC Properties] → [Code] → [DEC/BCD] takes effect.

## \*4 If any value (non-numeric inclusive) specified is outside the range usable on MONITOUCH, the value cannot be displayed.

 For details on the allowable range, refer to "5.1.4 Real Numbers (Floating Point Numbers)".

## \*5 Max., Min., Max. Scale, Min. Scale

Do not specify the same value for both maximum and minimum values. Doing so will result in an error when transferring data to the unit.  
Make sure to set valid values.

## \*6 When minimum and maximum values are set with a device memory address (other than [Constant]), these values are updated when the graph is displayed or when a "redraw" or a "redraw after clear" is commanded by the control device memory.

## Style

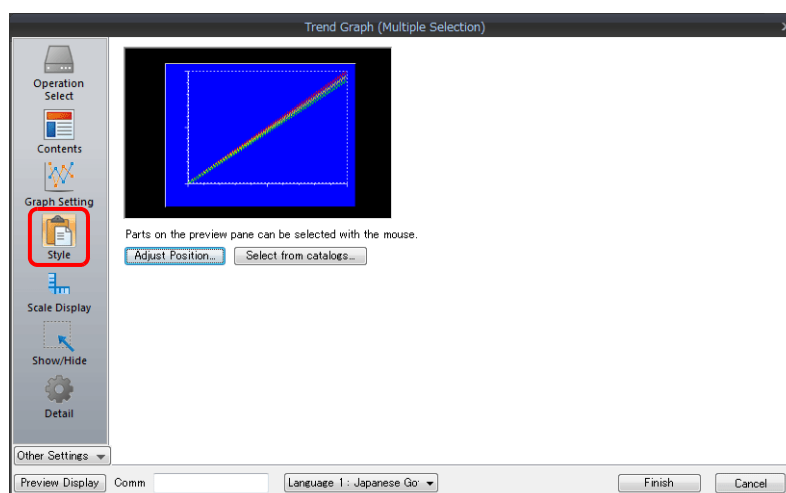

Item	Description
Adjust Position	Adjust the placement position.
Select from catalogs	Change parts.



## Scale Display

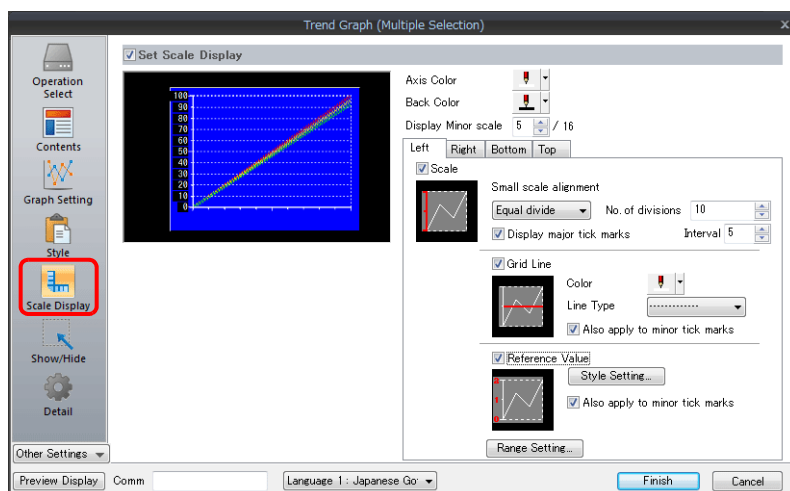

Item	Description													
Axis Color	Select the color of the major and minor tick marks, and axis lines of the scale.													
Back Color	This setting is common to all left, right, bottom, and top sides.													
Display Minor scale	Set the length of the minor tick marks of the scale. Range: 1 to 16 This setting is common to all left, right, bottom, and top sides. The thickness of the markings is fixed.													
[Scale] in [Left], [Right], [Bottom], and [Top] tab windows	Displays the scale, grid line, and reference value settings for each side. Default: Selected on [Left] and [Bottom] tab windows													
Small scale alignment	<p>Equal divide (unit based on [No. of divisions]) Minor tick marks are equally spaced according to the specified number of divisions along the axis line.</p> <p>Equal interval (unit based on [Interval]) Minor tick marks are equally spaced according to the specified interval from the zero point along the axis line within the following range.</p> <table border="1" style="margin-left: 40px;"> <thead> <tr> <th>Graph Direction</th> <th>Side</th> <th>Range</th> </tr> </thead> <tbody> <tr> <td>LFT/RTG</td> <td>Top/Bottom</td> <td rowspan="2">Number of horizontal axis points or scale of [Range Setting]</td> </tr> <tr> <td>UP/DW</td> <td>Left/Right</td> </tr> <tr> <td>LFT/RTG</td> <td>Left/Right</td> <td rowspan="2">Scale of [Range Setting]</td> </tr> <tr> <td>UP/DW</td> <td>Top/Bottom</td> </tr> </tbody> </table>	Graph Direction	Side	Range	LFT/RTG	Top/Bottom	Number of horizontal axis points or scale of [Range Setting]	UP/DW	Left/Right	LFT/RTG	Left/Right	Scale of [Range Setting]	UP/DW	Top/Bottom
Graph Direction	Side	Range												
LFT/RTG	Top/Bottom	Number of horizontal axis points or scale of [Range Setting]												
UP/DW	Left/Right													
LFT/RTG	Left/Right	Scale of [Range Setting]												
UP/DW	Top/Bottom													
Display major tick marks	Display major tick marks on the scale. (Unit: [Interval]) Length: Twice the minor tick marks Thickness: Fixed													
Grid Line	Grid lines are drawn at the major and minor tick marks of the scale.													
	<table border="1" style="width: 100%;"> <tr> <td style="width: 20%;">Color, Line Type</td> <td>Set the color and line type of grid lines.</td> </tr> <tr> <td>Also apply to minor tick marks</td> <td>This can be set when the [Display major tick marks] checkbox is selected. Set whether to display grid lines. Selected: Display at both major and minor tick marks Unselected: Only display at major tick marks</td> </tr> </table>	Color, Line Type	Set the color and line type of grid lines.	Also apply to minor tick marks	This can be set when the [Display major tick marks] checkbox is selected. Set whether to display grid lines. Selected: Display at both major and minor tick marks Unselected: Only display at major tick marks									
Color, Line Type	Set the color and line type of grid lines.													
Also apply to minor tick marks	This can be set when the [Display major tick marks] checkbox is selected. Set whether to display grid lines. Selected: Display at both major and minor tick marks Unselected: Only display at major tick marks													
Reference Value	Select this checkbox to display reference values at major and minor tick marks on the scale.													
	<table border="1" style="width: 100%;"> <tr> <td style="width: 20%;">Style Setting</td> <td>Set the number of digits or the color of reference values shown at tick marks.</td> </tr> <tr> <td>Also apply to minor tick marks</td> <td>This can be set when the [Display major tick marks] checkbox is selected. Set whether to display reference values. Selected: Display at both major and minor tick marks Unselected: Only display at major tick marks</td> </tr> </table>	Style Setting	Set the number of digits or the color of reference values shown at tick marks.	Also apply to minor tick marks	This can be set when the [Display major tick marks] checkbox is selected. Set whether to display reference values. Selected: Display at both major and minor tick marks Unselected: Only display at major tick marks									
Style Setting	Set the number of digits or the color of reference values shown at tick marks.													
Also apply to minor tick marks	This can be set when the [Display major tick marks] checkbox is selected. Set whether to display reference values. Selected: Display at both major and minor tick marks Unselected: Only display at major tick marks													
Range Setting	<p>Use when [Small scale alignment] is set to [Equal divide] or when the [Reference Value] checkbox is selected.</p> <p>Match with the specified graph The range changes according to the following combinations.</p> <table border="1" style="margin-left: 40px;"> <thead> <tr> <th>Graph Direction</th> <th>Side</th> <th>Range</th> </tr> </thead> <tbody> <tr> <td>LFT/RTG</td> <td>Top/Bottom</td> <td rowspan="2">Number of X-axis data points *1</td> </tr> <tr> <td>UP/DW</td> <td>Left/Right</td> </tr> <tr> <td>LFT/RTG</td> <td>Left/Right</td> <td rowspan="2">Minimum and maximum values specified for the selected graph number *2</td> </tr> <tr> <td>UP/DW</td> <td>Top/Bottom</td> </tr> </tbody> </table> <p>Set Value Specify the minimum and maximum values using constants or devices. *2</p>	Graph Direction	Side	Range	LFT/RTG	Top/Bottom	Number of X-axis data points *1	UP/DW	Left/Right	LFT/RTG	Left/Right	Minimum and maximum values specified for the selected graph number *2	UP/DW	Top/Bottom
Graph Direction	Side	Range												
LFT/RTG	Top/Bottom	Number of X-axis data points *1												
UP/DW	Left/Right													
LFT/RTG	Left/Right	Minimum and maximum values specified for the selected graph number *2												
UP/DW	Top/Bottom													

\*1 If [Plot Point Pitch] is set to [Specify the scale range], use the minimum and maximum scale values.

\*2 If the minimum and maximum values are specified with device memory addresses (other than [Constant]) in the [Range Setting] window and these values are changed in RUN mode, the changes are updated at the following timings:

- When the screen is redrawn
- The bit for "redraw" or "redraw after clear" in the control device memory is set to ON.

## Detail

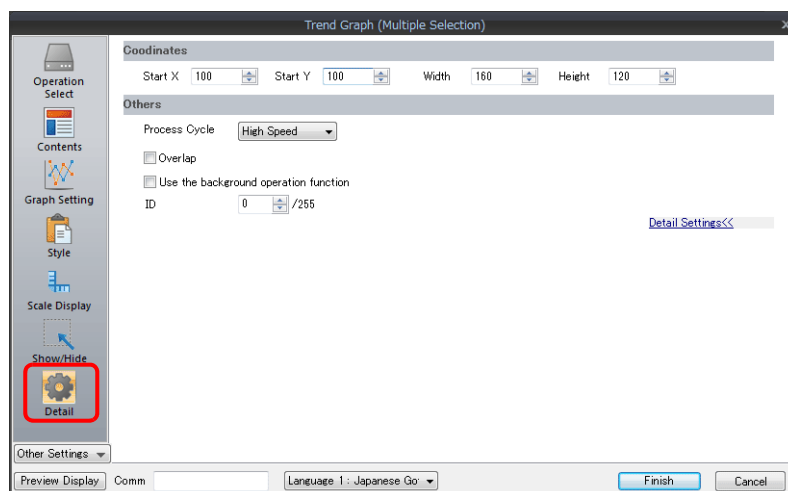

Item	Description
Coordinates	Set a display position and size.
Process Cycle	Set the cycle used to read the device memory. High Speed, Low Speed, Refresh
Overlap	Select this checkbox to display multiple graphs asynchronously or 17 or more lines in one graph area. For details, refer to "7.3.5 Asynchronous Display of Multiple Trend Graphs" page 7-43.
Use the background operation function	Update graphs in the background when other screens are displayed.
ID	Set an ID number.

### 7.3.3 Plot Point Pitch

Select whether to place plot points along the X-axis of graphs at equal pitches (intervals) or at variable pitches.

Location of setting: [Graph Setting] → [Plot Point Pitch]

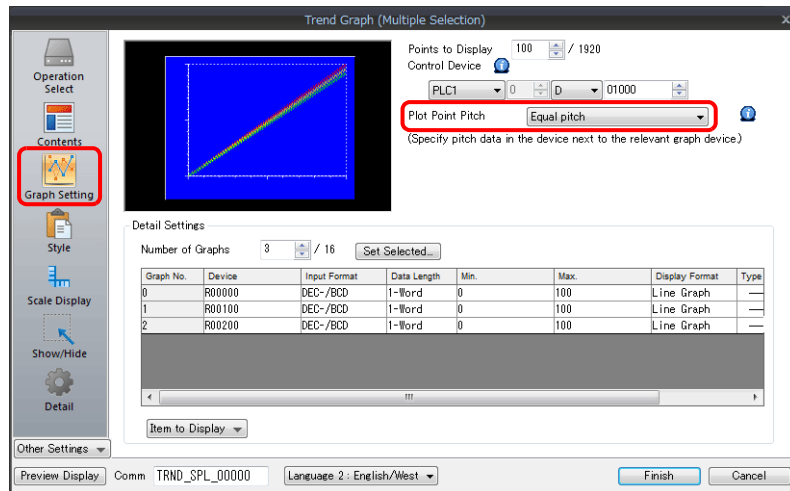

## Type

### Equal pitch

Plot points are automatically set at an equal pitch. MONITOUCH calculates a pitch between plot points as shown below. (MONITOUCH adjusts the data so that no remainder will result.)

Formula: Point pitch (dots) = X size of graph (dots) ÷ ([Points to Display] - 1)

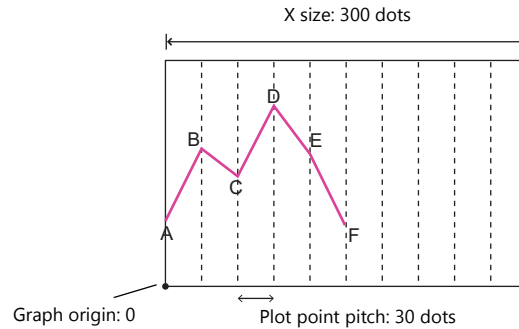

For details on device memory allocation, refer to ["Equal pitch" page 7-40](#).

### Specify the number of dots

Pitch data (distance from the graph origin to each plot point) can be specified in units of dots.

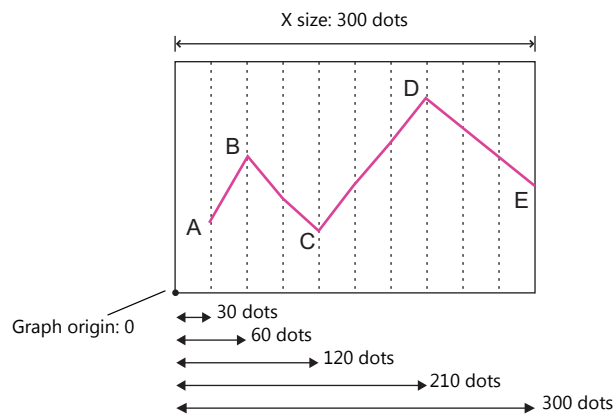

For details on device memory allocation, refer to ["Specify the scale range, specify the number of dots" page 7-41](#).

### Specify the scale range

Pitch data (distance from the graph origin to each plot point) can be specified using a scale value. The scale value is specified as the range in the [Graph Setting] settings. ([Max. Scale], [Min. Scale])

[Specify the scale range]

- [Min. Scale]: 0
- [Max. Scale]: 10

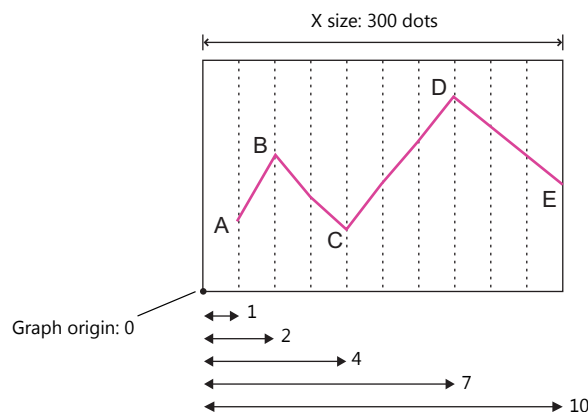

For details on device memory allocation, refer to ["Specify the scale range, specify the number of dots" page 7-41](#).

## Device Memory Allocation

The allocation of device memory addresses differs depending on the [Points to Display] setting and the data length of each graph.

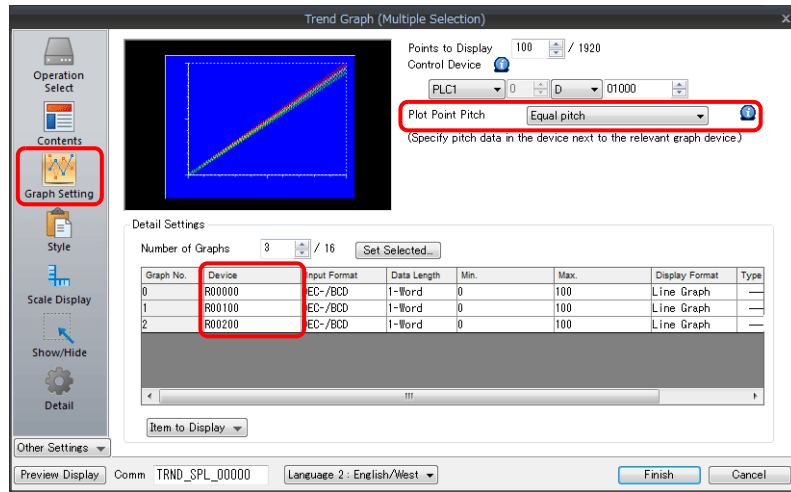

### Equal pitch

Point data is stored consecutively from the set device memory address.

Device memory address setting: n

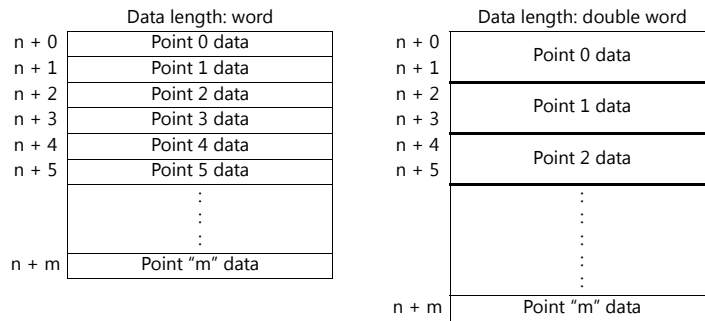

For example, allocation is performed as follows when 11 points are plotted on the X-axis and [Device] is D100.

- If the data length is 1 word, devices D100 to D110 are used.
- If the data length is 2 words, devices D100 to D121 are used.

Device memory address setting: D100

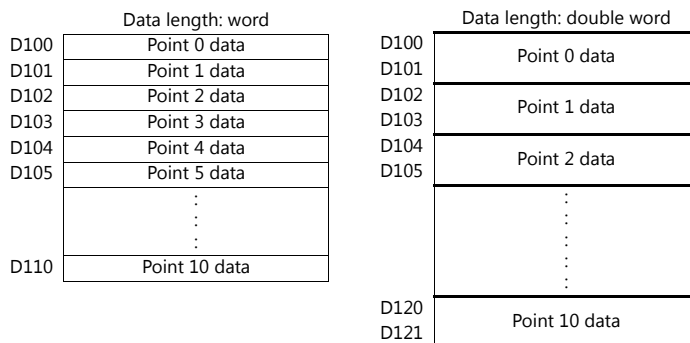

## Specify the scale range, specify the number of dots

Point data and pitch data (dot or scale value) from the set device memory address are stored one after the other. A device for pitch data is allocated following the device memory for each point.

Device memory address setting: n

Data length: word		Data length: double word	
n + 0	Point 0 data	n + 0	Point 0 data
n + 1	Point 0 pitch data	n + 1	
n + 2	Point 1 data	n + 2	Point 0 pitch data
n + 3	Point 1 pitch data	n + 3	
n + 4	Point 2 data	n + 4	Point 1 data
n + 5	Point 2 pitch data	n + 5	
	⋮	n + 6	Point 1 pitch data
	⋮	n + 7	
n + m	Point "m" data		⋮
	Point "m" pitch data	n + m	Point "m" data
			Point "m" pitch data

For example, allocation is performed as follows when 11 points are plotted on the X-axis and [Device] is D100.

- If the data length is 1 word, device memory addresses D100 to D121 are used.
- If the data length is 2 words, device memory addresses D100 to D141 are used.

Device memory address setting: D100

Data length: word		Data length: double word	
D100	Point 0 data	D100	Point 0 data
D101	Point 0 pitch data	D101	
D102	Point 1 data	D102	Point 0 pitch data
D103	Point 1 pitch data	D103	
D104	Point 2 data	D104	Point 1 data
D105	Point 2 pitch data	D105	
	⋮	D106	Point 1 pitch data
	⋮	D107	
D120	Point "m" data		⋮
D121	Point "m" pitch data	D140	Point 10 data
		D141	Point 10 pitch data

### 7.3.4 Display Method

This section explains the display method using an example of graph control device memory D1000.

1. Check the graph control device (e.g. D1000).  
Location of setting: [Trend] settings → [Graph Setting] → [Control Device]

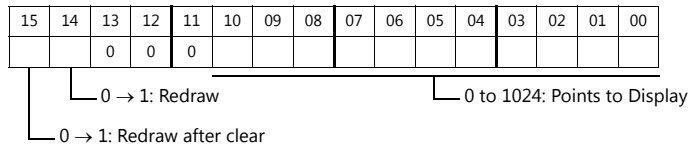
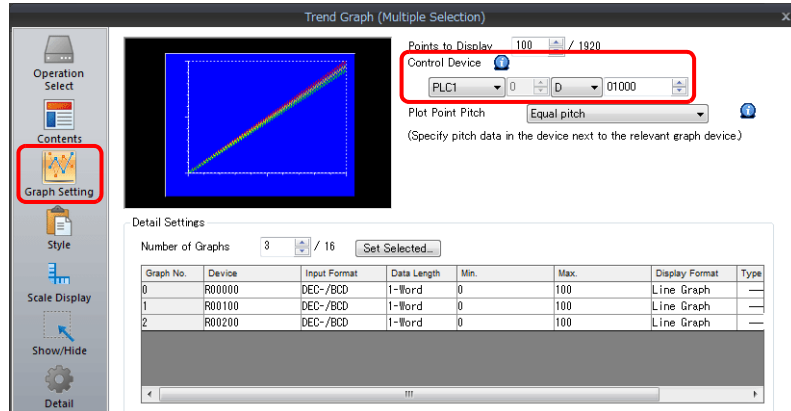

2. Set the control device to "11" (number of plotted points).
3. Change "redraw after clear" (bit 15) or "redraw" (bit 14) of the control device memory from 0 to 1.
  - Redraw after clear (bit 15)  
The previous graphs are cleared before displaying the latest graph.

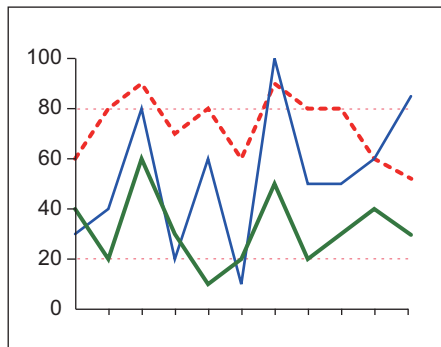

The graphs are displayed with the 11 most recent points.

- Redraw (bit 14)  
The previous graphs are not cleared and the latest graph is displayed.

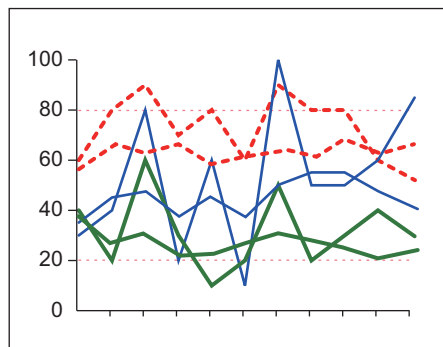

The latest graph with the 11 most recent points is displayed over the previous graph.

This completes the necessary settings.

## 7.3.5 Asynchronous Display of Multiple Trend Graphs

All the trend lines in the graph area are drawn at the same points and at the same timing because trend graphs have one word of control device memory. To draw multiple trend lines at different timings, two or more graphs must be overlaid and linked, thereby assigning priorities to respective control device memory.

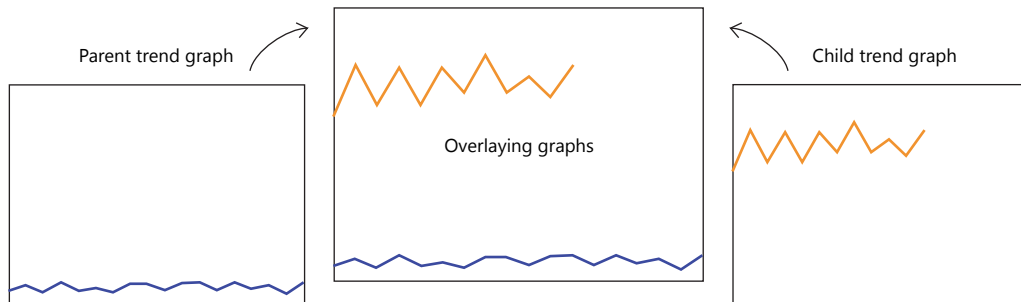

### Setting Procedure

This section explains drawing multiple graphs with an example of displaying two trend graphs asynchronously.

1. Place two trend graphs.

Refer to "7.3.1 Location of Settings" page 7-32.

2. Set D120 to [Graph Setting] → [Control Device] in the [Trend] settings window.

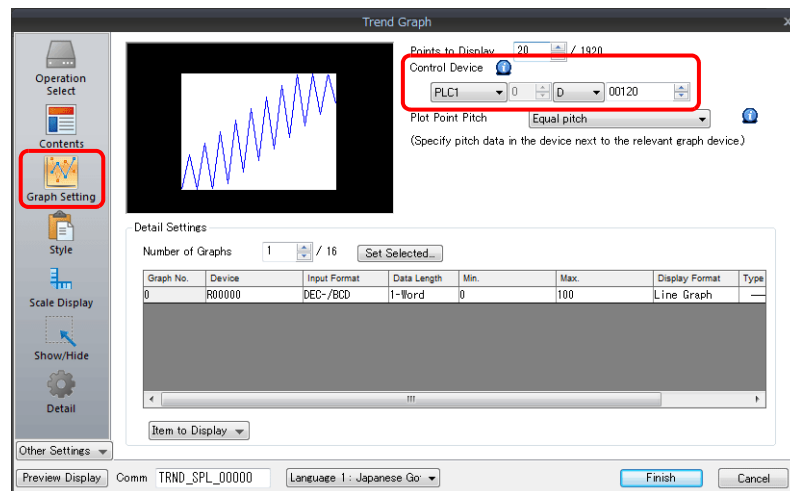

3. Set "High Speed" for [Detail] → [Process Cycle] and "0" for [ID] (parent trend graph).

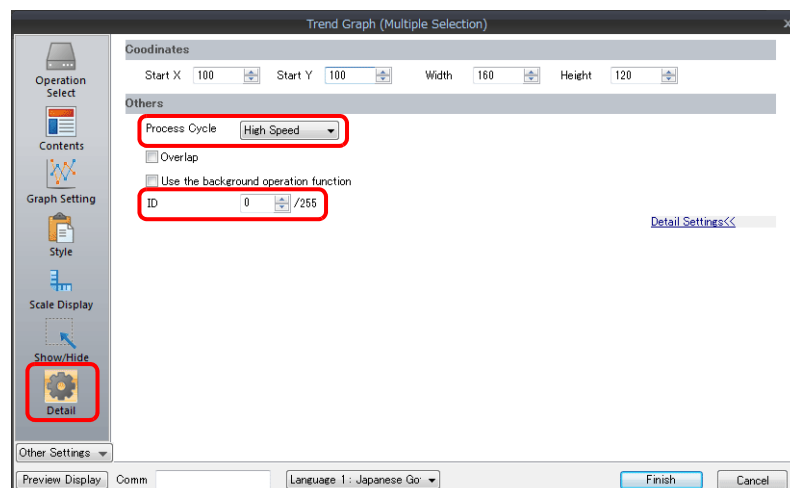



4. In the [Trend] settings window of the other graph, set D140 to [Graph Setting] → [Control Device].

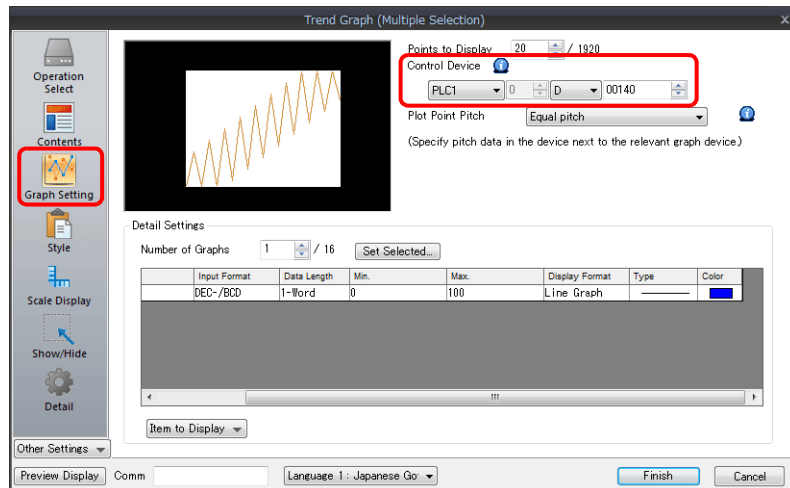

5. Set "High Speed" for [Detail] → [Process Cycle] and "0" for [Overlap] (child trend graph).

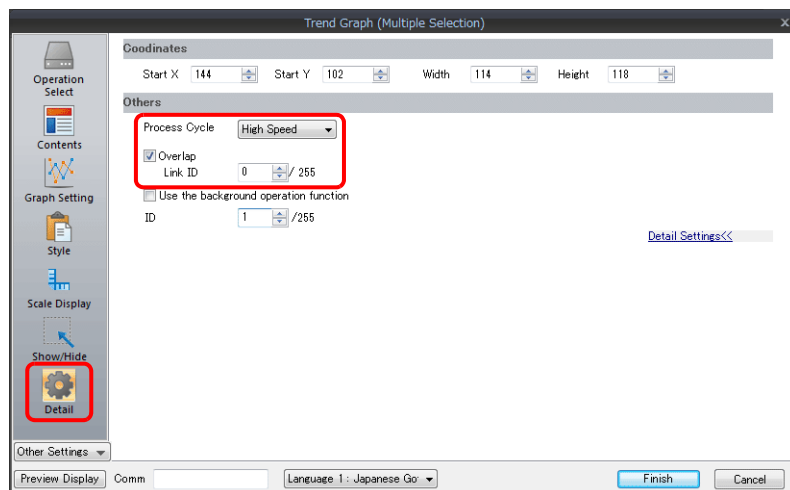

6. Place the parent trend graph under the child trend graph to overlap the two graphs.

This completes the necessary settings.

The graphs are drawn using the D120 control device memory (parent trend graph).

 For details on display, refer to "7.3.4 Display Method" page 7-42.

## Display Method

This section explains how to draw two trend graphs based on the example in "Setting Procedure" page 7-43.

1. Set D120 to 9H (number of plotted points).

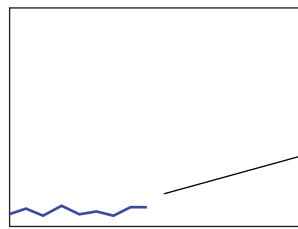

The parent trend graph is drawn with up to 9 plot points.

2. Set D140 to 9H (number of plotted points).

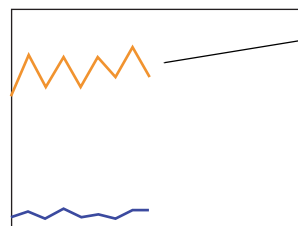

The child trend graph is drawn with up to 9 plot points.

3. Set the D140 to 5H (number of plotted points) and set D120 to 8007H ("redraw after clear" and number of plotted points).

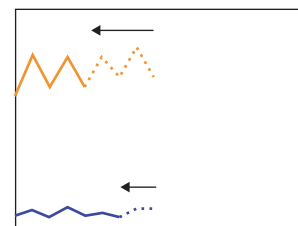

Change the number of plotted points to 5 points in the child trend graph and send the "change" and "redraw after clear" commands from the parent trend graph at the same time. The 5 points of the child trend graph are drawn for the first time.

## Notes on Setting

- When linking two or more trend graphs, regard one trend graph as a "parent" and the other trend graph as a "child." Select the [Detail] → [Overlap] checkbox for the child trend graph and set the ID of the parent trend graph. Both the "redraw" and "redraw after clear" commands issued at the child trend graph are ignored and only the commands from the control device memory of the parent trend graph are accepted.
- Set [Process Cycle] to "High Speed" for all the trend graphs that are linked.
- Only the area property settings of the parent trend graph are available. The area property settings of the child trend graph are not displayed. In addition, the reference lines set for the child trend graph area ignored.
- Place the child trend graph over the parent trend graph using the [Bring to Top] or [Send to Bottom] icon. If the parent trend graph is placed over the child trend graph, these two graphs will not be linked correctly.

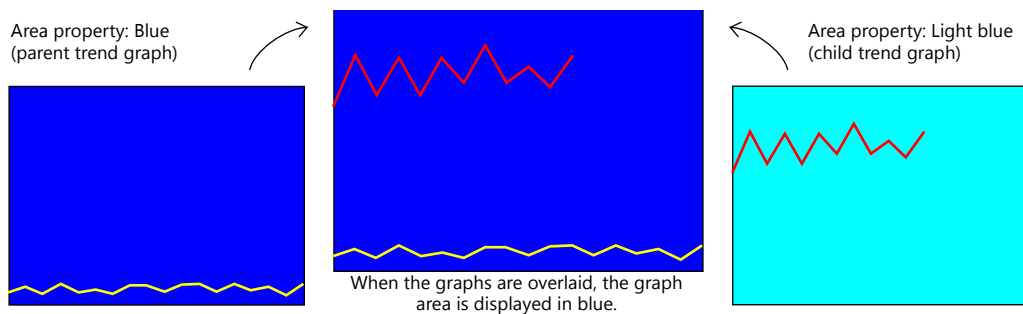

## 7.3.6 Background Update

Graphs can be updated even when displaying screens that do not contain trend graph parts.

Display example: [Number of Graphs]: 1  
 [Points to Display]: 9  
 [Control Device]: D100 (redraw command bit: 14th bit)

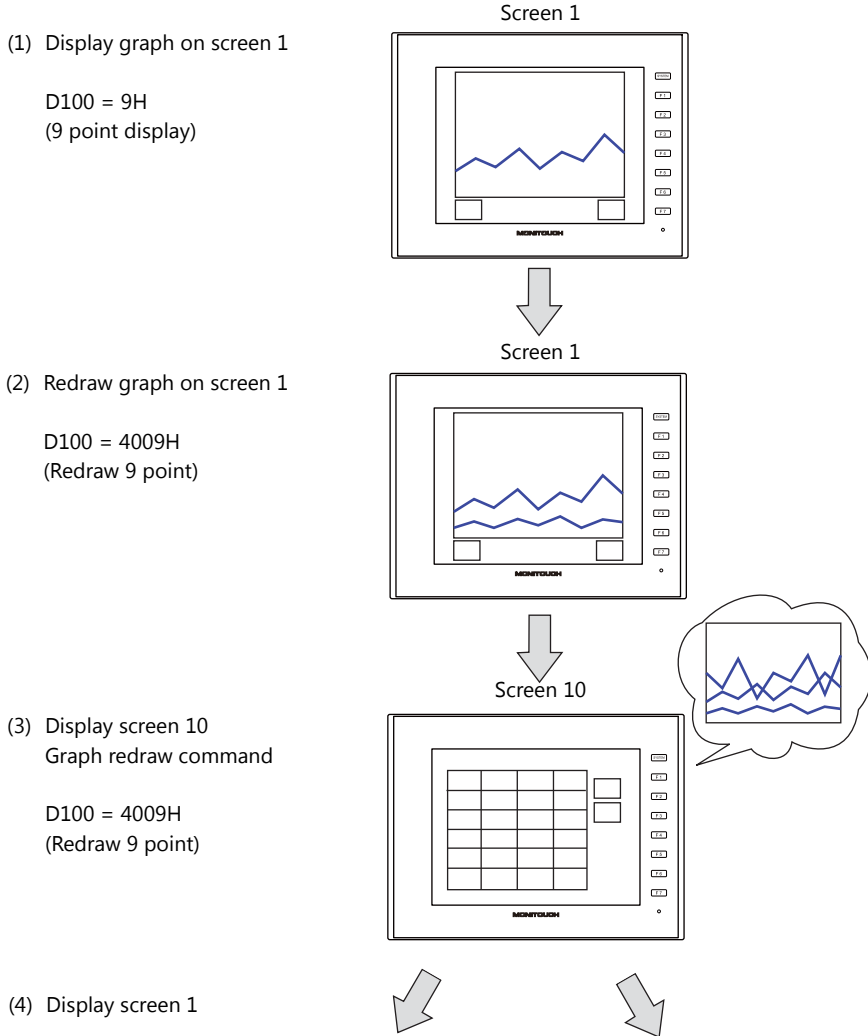

- [Use the background operation function] checkbox unselected

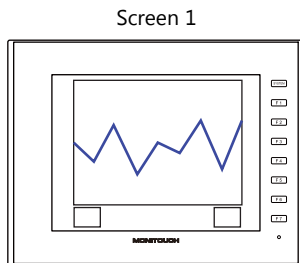

Only update the latest state (latest single graph line only)

- [Use the background operation function] checkbox selected

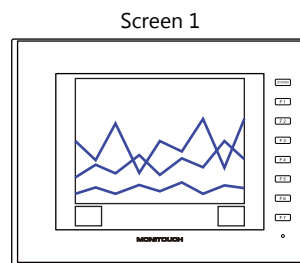

Display the graph updated by the command in step 2 (three graph lines)

\* Previous graph lines remain until the redraw clear bit is turned ON.

## Location of Settings

[Detail] → [Use the background operation function]

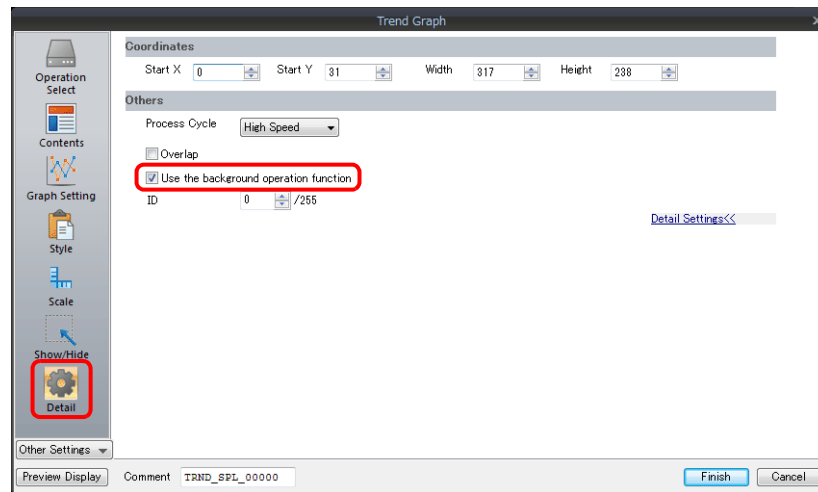

## Notes on Setting

- The maximum number of trend parts using the background operation function that can be placed in one screen is 256.
- This function cannot be used with component parts.

# MEMO

MONITOUCH



## **8 Alarm**

---

8.1 Overview

8.2 Alarm Server

8.3 Date and Time Display Setting

8.4 Alarm Parts

# 8.1 Overview

- Alarm server  
The states of devices registered to an alarm server can be saved as alarm history. History data can be output to a CSV file on a storage device by turning the relevant bit ON for checking on a PC.

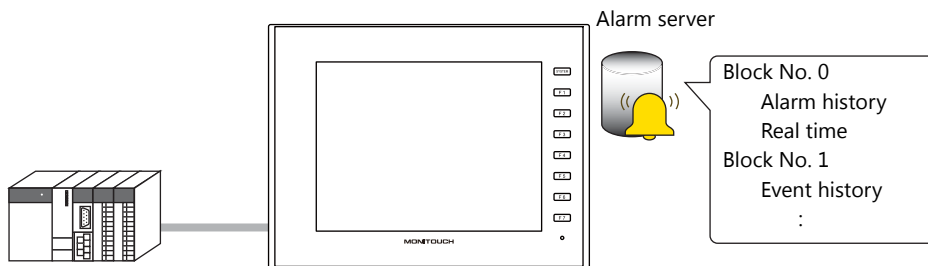

☞ "Alarm Server" page 8-7

- Alarm parts  
Placing alarm parts on the screen allows history data saved on an alarm server to be displayed in conjunction with certain times and messages. There are three alarm types to alarm parts.

- Alarm history  
Alarm occurrence, reset, and acknowledged times are displayed on one line. The state of each alarm can be checked at a glance.

Title display →

Message	Occurrence time	Acknowledged time	Reset time	PAGE
Temperature rise of Tank-A	05/10 08:12:40	05/10 08:15:30	05/10 09:30:40	↑
Lack of materials	05/10 15:15:43	05/10 15:30:25	*****	↑
Worker change	05/10 17:00:00	*****	05/10 17:05:00	○
Abnormality of conveyor A-Line	05/10 19:59:15	*****	*****	↓
				↓ PAGE

Change DISPOrder   Display Change-over   Reset   DEL   ACK   ACK ALL   Filter   File

- Event history  
Alarm occurrence, reset, and acknowledged times are each displayed on one line.

Title display →

Message	Event Name	Time	Group Name	PAGE
Temperature rise of Tank-A	Occurrence	05/10 08:12:40	Serious fault	↑
Temperature rise of Tank-A	Acknowledge	05/10 08:15:30	Serious fault	↑
Temperature rise of Tank-A	Cancel	05/10 08:15:40	Serious fault	○
Temperature rise of Tank-A	Occurrence	05/10 15:15:43	Serious fault	↓
Temperature rise of Tank-A	Cancel	05/10 15:30:25	Cancel	↓ PAGE
Lack of materials	Occurrence	05/10 17:00:00	Minor fault	
Lack of materials	Cancel	05/10 17:05:00	Minor fault	
Worker change	Occurrence	05/10 19:59:15	Serious fault	
Worker change				
Abnormality of conveyor A-Line				

Change DISPOrder   Display Change-over   Reset   DEL   ACK   ACK ALL   Filter   File

- Real time display

This screen will only display alarms that are currently occurring. Alarms that require resetting can be checked at a glance.

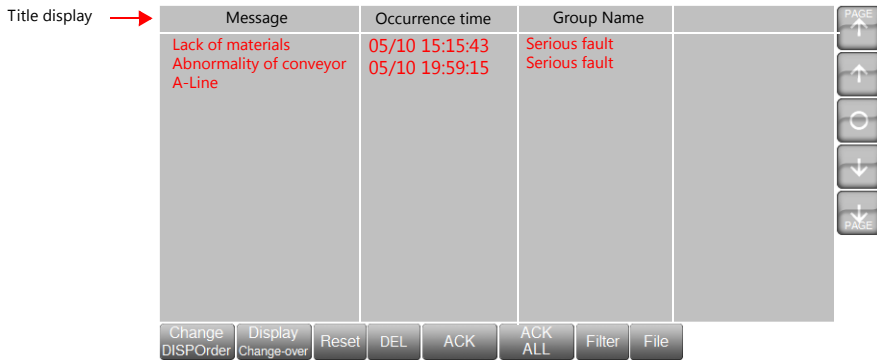

• Action when alarms occur

Six actions can be set to occur according to the alarm that occurred.

1) Scrolling messages

When an alarm occurs, an alarm message is automatically displayed at the bottom (or top) of the screen. Displaying the scroll tool allows the display position to be changed or automatic scrolling to be paused. Scrolling messages are displayed continually until the error is reset even if the screen is changed.

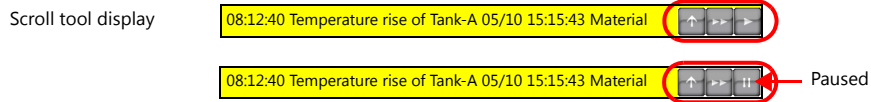
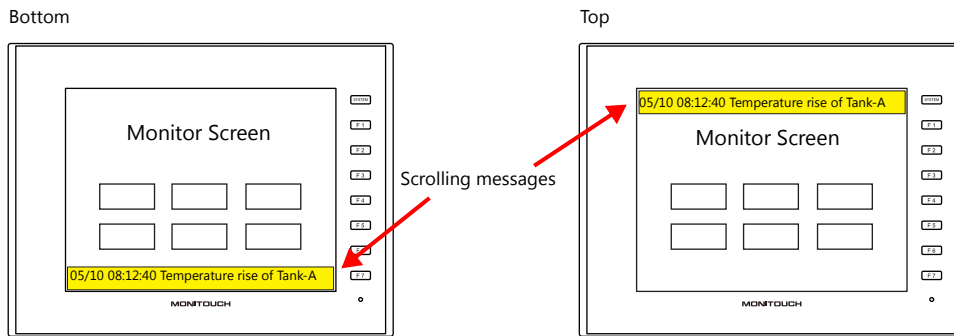

👉 "Scrolling Messages" page 8-18

2) Playing sounds

An audio file can be played when an alarm occurs. (Standard model only)

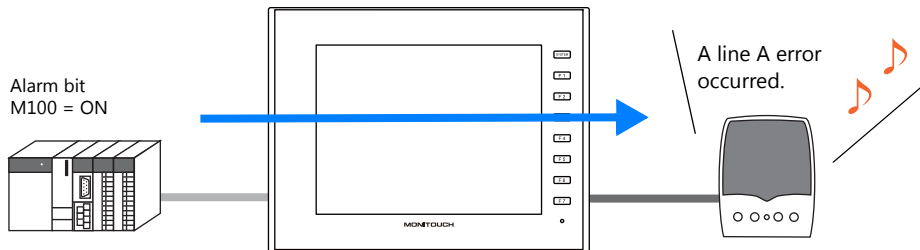

👉 "Playing Sounds" page 8-20



3) E-Mail

Send an e-mail when an alarm occurs or is reset. When using a multi-language screen, e-mails are sent in all languages.

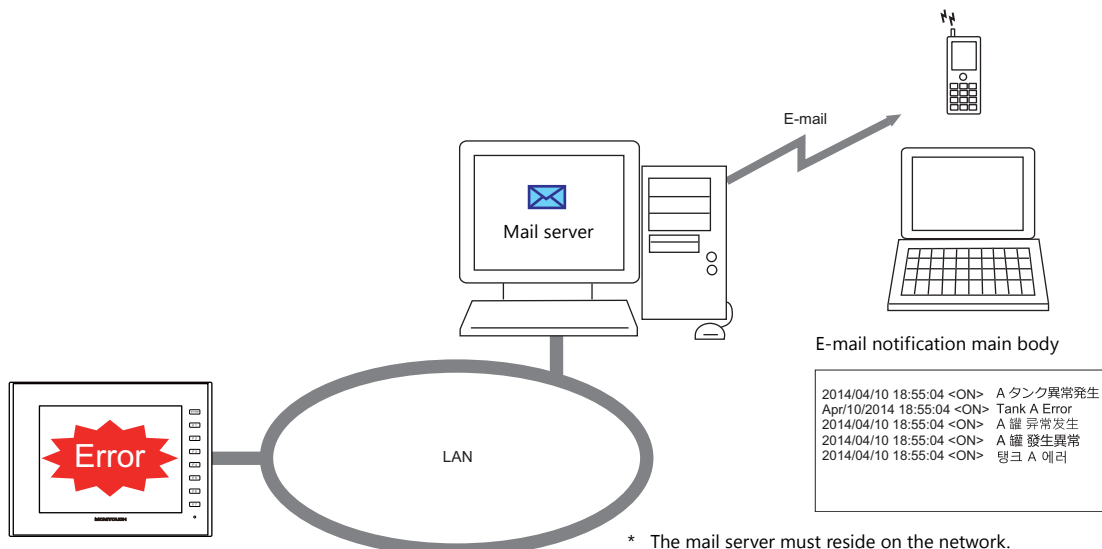

☞ "E-mail Notification" page 8-21

4) Operation Setting

Operations including output to a specified device memory address, display changeover, and macro execution can be performed when an alarm occurs.

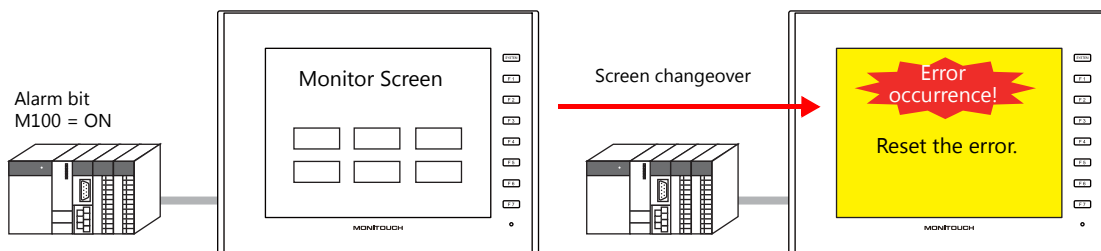

☞ "Operation Setting" page 8-22

5) Parameter display

When an alarm occurs, the data (parameters) associated with the alarm can be saved/displayed together with an alarm message. Logging the history of such alarm-relevant parameters will make it easier to locate and investigate the causes of alarms.

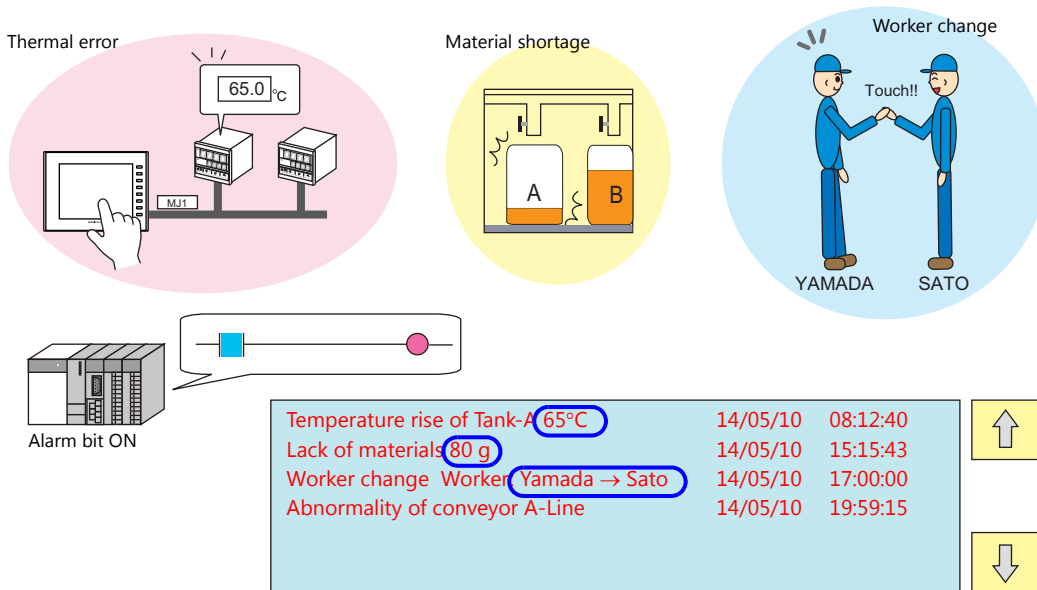

☞ "Parameters" page 8-24

6) Touch action

The screen can be changed by tapping the message on the alarm part.  
More detailed alarm information can be displayed.

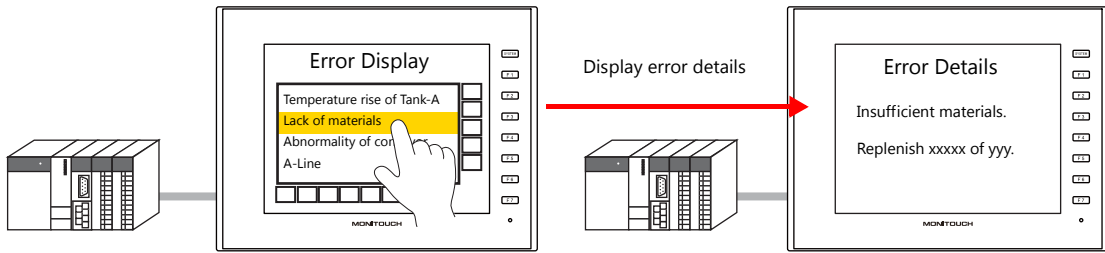

"Touch Action" page 8-26

• Alarm part display/operation

- Title display/operation

A title can be added to each item in alarm parts.

Title display →

Message	Occurrence time	Acknowledged time	Reset time	
Temperature rise of Tank-A	05/10 08:12:40	05/10 08:15:30	05/10 09:30:40	PAGE ↑ ○ ↓ PAGE
Lack of materials	05/10 15:15:43	05/10 15:30:25	*****	
Worker change	05/10 17:00:00	*****	05/10 17:05:00	
Abnormality of conveyor A-Line	05/10 19:59:15	*****	*****	

Change DISPOrder   Display Change-over   Reset   DEL   ACK   ACK ALL   Filter   File

- Scrolling function

If the area width is insufficient to display all items, the screen can be scrolled by touch operation.

Scroll ←

Occurrence time	Acknowledged time	Reset time	Group Name	
05/10 08:12:40	05/10 08:15:30	05/10 09:30:40	Serious fault	PAGE ↑ ○ ↓ PAGE
05/10 15:15:43	05/10 15:30:25	*****	Serious fault	
05/10 17:00:00	*****	05/10 17:05:00	Serious fault	
05/10 19:59:15	*****	*****	Serious fault	

Change DISPOrder   Display Change-over   Reset   DEL   ACK   ACK ALL   Filter   File

- Backup file display  
Use the [File] switch to redisplay backup files (BIN) output to a storage device.

The screenshot shows a backup file display interface. At the top, there is a table with columns: Message, Occurrence time, Acknowledged, and Reset time. The messages include 'Temperature rise of Tank-A', 'Lack of materials', 'Worker change', and 'Abnormality of conveyor A-Line'. Below the table is a control bar with buttons: Change DISPOrder, Display Change-over, Reset, DEL, ACK, ACK ALL, Filter, and File. A red circle highlights the 'File' button. To the right, a dialog box titled 'Select date and time.' is open, showing a list of dates: 2014/03/01, 2014/03/27, and 2014/05/10. The '2014/05/10' date is selected. The dialog also shows times: 12:30:14 and 19:05:14. At the bottom of the dialog are buttons: Display the Latest Log, Cancel, and Open Log File. A red circle highlights the 'Open Log File' button. Below the dialog, the main table is updated with messages from 03/01 to 03/03. A red arrow points from the 'Open Log File' button in the dialog to the 'File' button in the control bar.

Message	Occurrence time	Acknowledged	Reset time
Temperature rise of Tank-A	05/10 08:12:40	05/10 08:15:30	05/10 09:30:40
Lack of materials	05/10 15:15:43	05/10 15:30:25	*****
Worker change	05/10 17:00:00	*****	05/10 17:05:00
Abnormality of conveyor A-Line	05/10 19:59:15	*****	*****

Message	Occurrence time	Acknowledged	Reset time
Temperature rise of Tank-A	03/01 07:50:40	03/01 08:15:30	03/01 08:15:30
Temperature rise of Tank-B	03/01 07:50:43	03/01 08:15:30	03/01 08:15:30
Temperature rise of Tank-C	03/01 07:50:50	03/01 08:15:30	03/01 08:15:30
Lack of materials	03/01 12:05:10	03/01 12:10:35	03/01 12:10:35
Worker change	03/01 15:15:25	03/01 15:30:25	03/01 15:30:25
Abnormality of conveyor A-Line	03/02 17:00:00	*****	03/02 17:00:02
Abnormality of conveyor B-Line	03/02 19:59:15	*****	03/02 21:20:02
Worker change	03/02 21:18:00	*****	03/02 21:20:02
Lack of materials	03/02 22:00:00	*****	03/02 22:10:02
Lack of materials	03/02 22:03:15	*****	03/02 22:10:02
Worker change	03/03 05:00:00	*****	03/03 05:00:10

- Filter display

Use the [Filter] switch to select display in groups or display according to state (Occurrence, Reset, Check, Normal).

Example: Changing from display of all items to only occurring and acknowledged items.

Display all items

Message	Occurrence time	Acknowledged time	Reset time	
Temperature rise of Tank-A	05/10 08:12:40	05/10 08:15:30	05/10 09:30:40	PAGE ↑ ↑ ○ ↓ ↓ PAGE
Lack of materials	05/10 15:15:43	05/10 15:30:25	*****	
Worker change	05/10 17:00:00	*****	05/10 17:05:00	
Abnormality of conveyor A-Line	05/10 19:59:15	*****	*****	

Change DISPOrder   Display Change-over   Reset   DEL   ACK   ACK ALL   **Filter**   File

Select items to display.

Group Name	Occurrence	Reset	Check	Normal	Batch Disp. Change
major	<input checked="" type="checkbox"/>	<input type="checkbox"/>	<input checked="" type="checkbox"/>	<input type="checkbox"/>	<input type="button" value="ON"/>
minor	<input checked="" type="checkbox"/>	<input type="checkbox"/>	<input checked="" type="checkbox"/>	<input type="checkbox"/>	<input type="button" value="ON"/>

Displaying occurring and acknowledged items

Message	Occurrence time	Acknowledged time	Reset time	
Lack of materials	05/10 15:15:43	05/10 15:30:25	*****	PAGE ↑ ↑ ○ ↓ ↓ PAGE
Abnormality of conveyor A-Line	05/10 19:59:15	*****	*****	

Change DISPOrder   Display Change-over   Reset   DEL   ACK   ACK ALL   Filter   File

## 8.2 Alarm Server

### 8.2.1 Alarm Server

The area that stores the alarm history is referred to as an alarm server.

Set an alarm server via [System Setting] → [Alarm Server] or [View] → [Project] → [Project View] window.

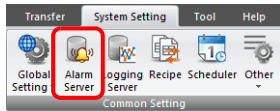

OR

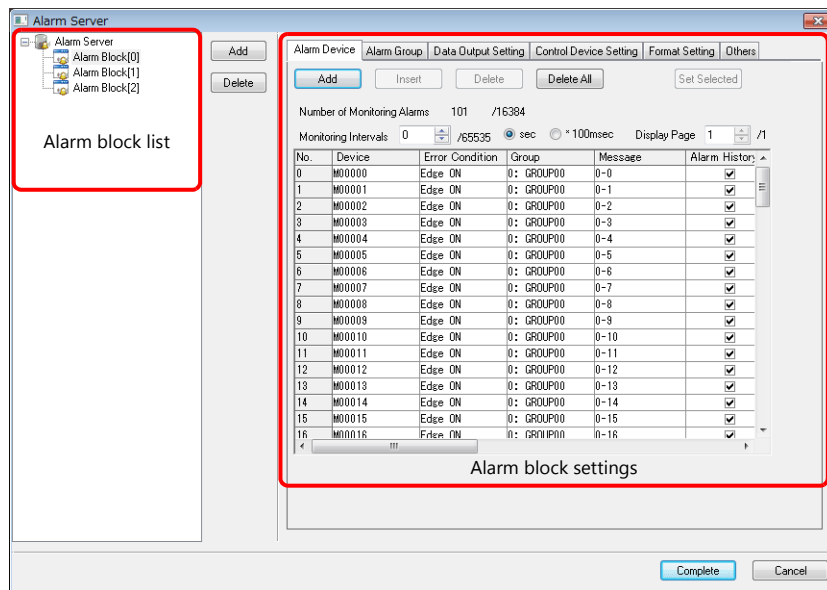
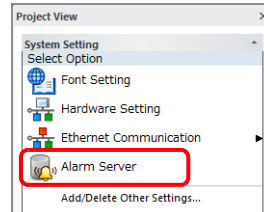

Item	Description
Alarm block list	A list of registered alarm blocks is displayed. Alarm block numbers 0 to 11 (total of 12) can be registered.
Add	Screen program converted from V8 to V9 is displayed as V8 compatible. Add an alarm block.
Delete	Delete an alarm block.
Alarm block settings <sup>*1</sup>	Perform detailed configuration of the alarm block selected in the alarm block list. Refer to "8.2.2 Alarm Block Settings" page 8-8

\*1 Alarm blocks can also be configured from the [Monitoring Alarm] settings in the alarm part settings window.

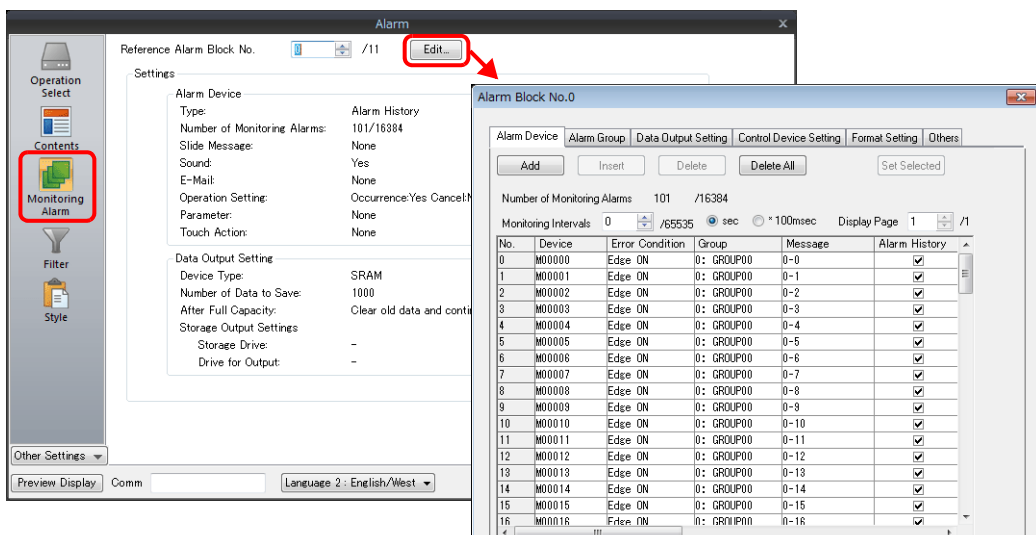

## 8.2.2 Alarm Block Settings

### Alarm Device

Register alarm device memory and configure error conditions.

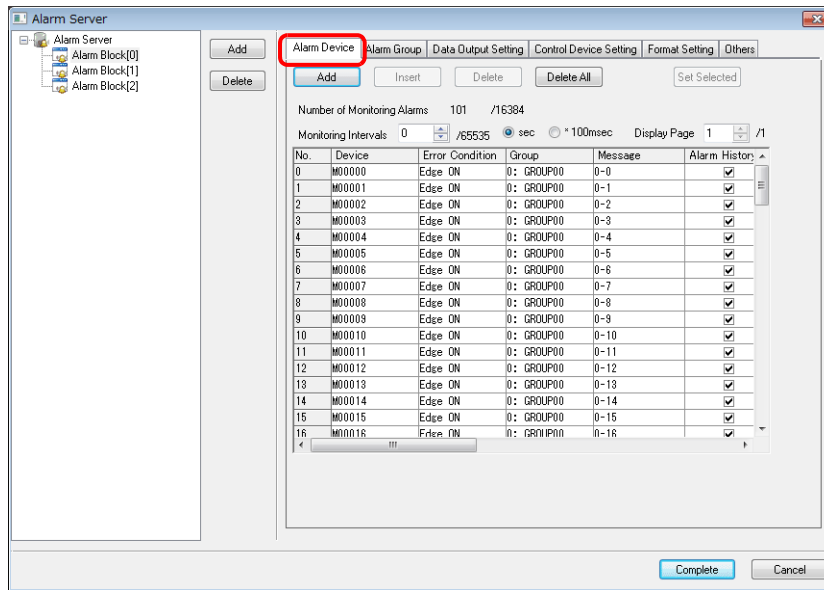

Item	Description																				
Number of Monitoring Alarms	Register a monitoring alarm using the [Add], [Insert], [Delete], [Delete All], and [Set Selected] buttons. The number of registered alarms is displayed. 1 - 16384																				
Add	Add an alarm device memory to the bottom of the list. A device memory address is automatically allocated by adding "1" to the device memory address in the last row on the list.																				
Insert	Insert an alarm device memory under the selected row. A device memory address is automatically allocated by adding "1" to the device memory address in the selected row.																				
Delete	Delete the selected alarm device memory.																				
Delete All	Delete all registered alarm device memory.																				
Set Selected <sup>*1</sup>	Batch copy the settings of the selected cell to other cells. <table border="1" style="margin-left: 20px;"> <thead> <tr> <th colspan="2">Item</th> <th>Settings</th> </tr> </thead> <tbody> <tr> <td colspan="2">Device</td> <td>Automatic device memory address increment</td> </tr> <tr> <td colspan="2">Error Condition</td> <td>Batch copy</td> </tr> <tr> <td colspan="2">Group</td> <td></td> </tr> <tr> <td colspan="2">Message</td> <td>Automatic message number increment</td> </tr> <tr> <td>Alarm types</td> <td>Alarm history Event history Real time</td> <td rowspan="2">Batch copy</td> </tr> <tr> <td>Actions</td> <td>Scrolling messages Sound E-Mail Operation Setting Parameters Touch action</td> </tr> </tbody> </table>	Item		Settings	Device		Automatic device memory address increment	Error Condition		Batch copy	Group			Message		Automatic message number increment	Alarm types	Alarm history Event history Real time	Batch copy	Actions	Scrolling messages Sound E-Mail Operation Setting Parameters Touch action
Item		Settings																			
Device		Automatic device memory address increment																			
Error Condition		Batch copy																			
Group																					
Message		Automatic message number increment																			
Alarm types	Alarm history Event history Real time	Batch copy																			
Actions	Scrolling messages Sound E-Mail Operation Setting Parameters Touch action																				
Monitoring Intervals	Set the monitoring frequency of the alarm device memory. 0: Every cycle 100 msec - 65535 sec																				
Device	Set the alarm device memory																				

Item	Description
Error Condition	Set the error conditions of the device memory
Edge ON	Bit OFF → ON: Error occurrence Bit ON → OFF: Error reset
Edge OFF	Bit ON → OFF: Error occurrence Bit OFF → ON: Error reset
Range Designation	Set the comparison condition expression for the value of the device memory address.  Data length: Set the data length of the condition value. 1-Word/2-Word  Constant Set the format of the comparison condition expression. DEC+~/DEC/BCD
Group	No.0 - 15 Set which alarm group the alarm device memory belongs to. For details on alarm groups, refer to <a href="#">page 8-10</a> .
Message	Register an alarm message.
GNo.0 - 127 No.0 - 255	Set the group number and line number to which an alarm message is to be registered. Display the [Message Edit] window by clicking the [Edit] button.
Message Lines	Set the number of lines of the alarm message.
Alarm types	Set the history type. Multiple types can be selected. Match the [Display Mode] of alarm items when alarm messages are to be checked on MONITOUCH.  * When none are selected, the alarm is disabled even if [Error Condition] is satisfied. In this case, no history is recorded. This is useful when registering a device memory for future use.
Alarm History	Alarm occurrence, reset, and acknowledged times are all displayed on one line. The state of each alarm can be checked at a glance.
Event History	Alarm occurrence, reset, and acknowledged times are each displayed on one line.
Real Time	This screen will only display alarms that are currently occurring. Alarms that require resetting can be checked at a glance.
Actions	Set the action to perform when an alarm occurs.
Flowing Message	An alarm message is automatically displayed at the bottom (or top) of the screen. It is displayed continually until the error is reset even if the screen is changed. Refer to <a href="#">page 8-18</a>
Sound	Play back an audio file. Refer to <a href="#">page 8-20</a> .
E-Mail	Send an e-mail. Refer to <a href="#">page 8-21</a> .
Operation Setting	Perform operations including writing to the specified device memory address (output setting), screen changeover / overlap control (function), and macro execution (macro). Refer to <a href="#">page 8-22</a> .
Parameter	When an alarm occurs, the data (parameters) associated with the alarm can be saved/displayed together with an alarm message. Refer to <a href="#">page 8-24</a> .
Touch Action	Change the screen by touching the alarm message. The [Enable the touch-action function] checkbox must be selected at [Detail] → [Auxiliary Function] in the alarm part settings window. Refer to <a href="#">page 8-26</a> .
Display Language	Change the display language when using multi-language screens.
Display Page	Each page displays 512 monitoring alarms.

## \*1 Batch setting of devices

- 1) Select a cell to set a device memory address.
- 2) With the cell in the selected state (highlighted in blue), click [Set Selected]. The [Set Selected] window is displayed.

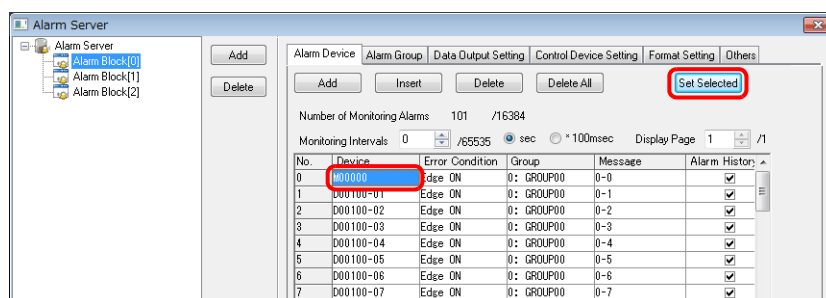

- 3) Select the alarm range for batch setting and click [Run]. A confirmation message is displayed.

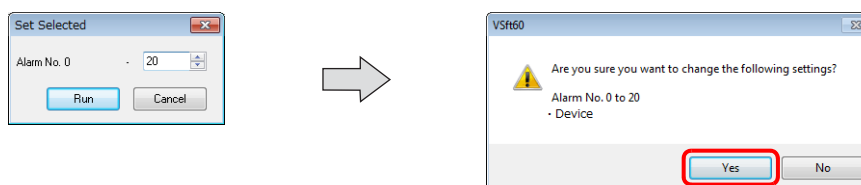

- 4) Check that the setting range is correct and click [Yes]. The device memory addresses of the specified range are changed.

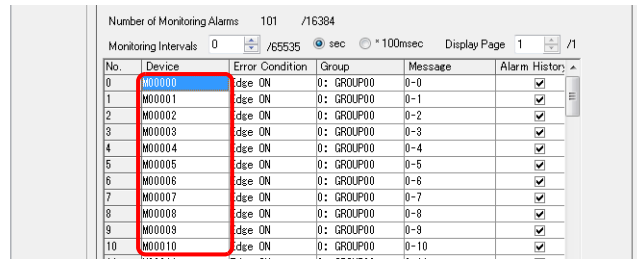

## Alarm Group

Set the color of alarm messages. Because up to 16 groups can be created, the color can be changed according to the severity of alarms.

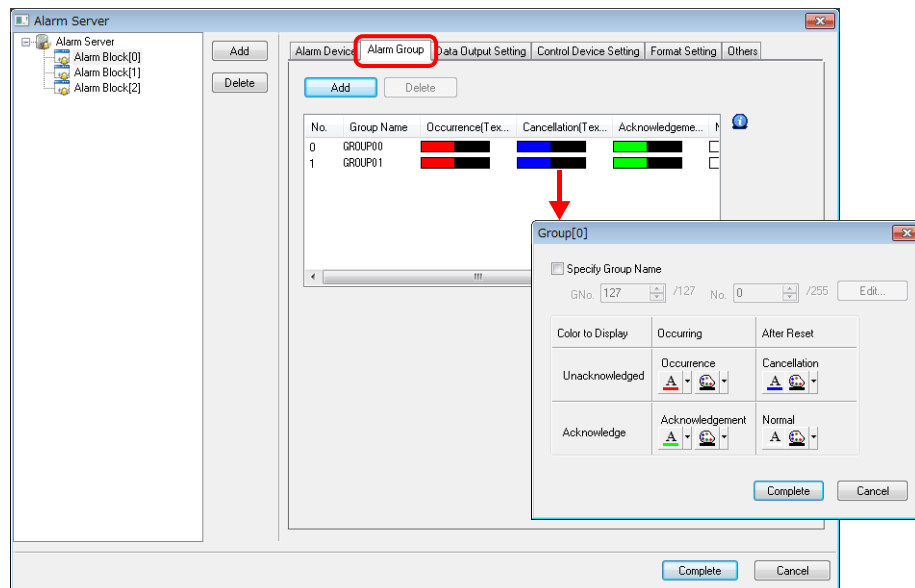

Item	Description
Alarm Group	Create groups with the [Add] button. 0 - 15
Add	Add a group.
Delete	Delete a group. There must be at least one group at all times. If all groups are deleted by the [Delete] or [Delete All] button, a new group is automatically created as No. 0.
Group settings	Set the name and color of each group.
Specify Group Name	Unselected GROUPxx (xx: 00 to 15) is set automatically.  Selected GNo. / No. Register the group name in the message editor. Display the [Message Edit] window by clicking the [Edit] button.
Color to Display	Set the text color and background color of each alarm state.  Occurrence: Alarm occurring, unacknowledged Cancellation: Alarm reset, unacknowledged Acknowledgment: Alarm occurring, acknowledged Normal: Alarm reset, acknowledged
Display Language	When specifying a group name on a multi-language screen, group titles can be displayed according to the display language.



## Data Output Setting

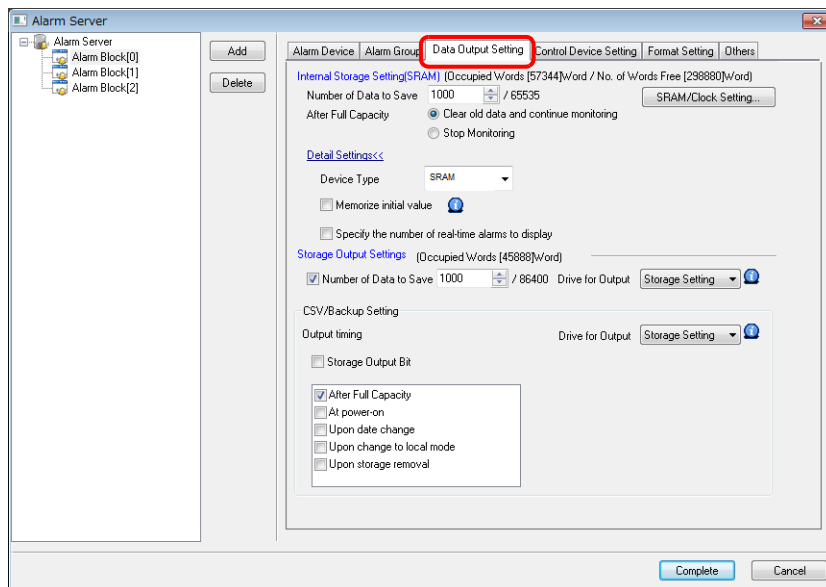

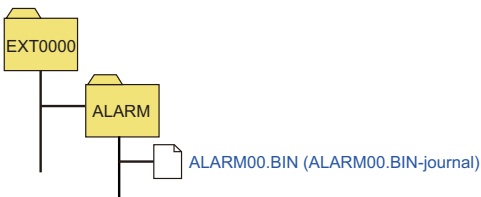
Item	Description
Internal Storage Setting	Configure the settings for history stored in SRAM.
Number of Data to Save	Set the number of alarms to save. Occurrence, cancellation, and acknowledgment each count as one alarm entry. 1 - 65535
After Full Capacity	Set the operation to perform when the value of [Number of Data to Save] is exceeded. Clear old data and continue monitoring Stop Monitoring
SRAM/Clock Setting	Display the [SRAM/Clock Setting] window. The amount of free space and total used space in SRAM can be checked.
Detail Settings	Device Type Set the save destination. SRAM: History is retained even when power is turned OFF or when switched to Local mode. DRAM: All history is cleared when power is turned OFF or the screen is changed to local mode.
	Memorize initial value In the state where an alarm is occurring, set the operation to perform when power to the unit is turned ON or when switched from Local mode to RUN mode.  Selected The error occurrence is not logged again because the latest state of the bit is recorded.  Unselected The history of the error occurrence is logged again.
	Specify the number of real-time alarms to display Real time display Set the number of errors to display when multiple errors occur at the same time.  Example: When the maximum display number is set to 50 If error number 51 occurs, only 50 error messages are displayed.
Storage Output Settings	Output data saved in the internal storage settings to the storage device.   Output destination (output drive)\access folder\ALARM folder  Filename (xx: block No.) Alarm history: ALARMxx.BIN (ALARMxx.BIN-journal <sup>*1</sup> ) Event history: EVENTxx.BIN (EVENTxx.BIN-journal <sup>*1</sup> )  Output timing <ul style="list-style-type: none"> <li>When the internal storage settings become full</li> <li>When the mode is switched from RUN to STOP</li> <li>When the [Storage Removal] switch is pressed</li> <li>At power-on (only when SRAM is selected)</li> <li>When a reset is performed (reset switch/reset bit ON)</li> <li>When the SAMPLE macro (V8 compatible) is executed</li> </ul>

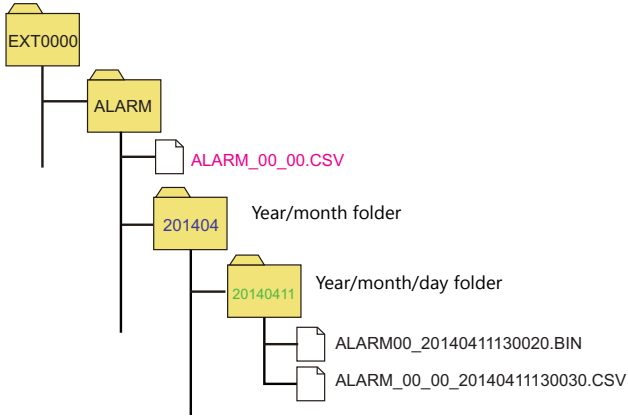
Item	Description
Number of Data to Save	Set the amount of data to save to the storage device. Occurrence, reset, and acknowledgement are each counted as a single data entry. If this setting is not configured, a BIN file is not created in the ALARM folder. SRAM history data is output to the backup folder.
Drive for Output	Set the output destination for the ALARMxx.BIN/EVENTxx.BIN files. Storage Setting <sup>*2</sup> C: Built-in Socket D: USB-A Port
CSV/Backup Setting	<p>Output a CSV file and backup file (BIN/CSV) to the storage device. <sup>*3</sup></p>  <p>CSV output Output destination (output drive)\access folder\ALARM</p> <p>CSV Filename Set at [Format Setting] → [CSV Format Setting] → [File Name]. ALARM_00_00.CSV (default)</p> <p>Backup file output Output destination (output drive)\access folder\ALARM\year/month folder\year/month/day folder</p> <p>BIN filename (xx: block No.) Alarm history: ALARMxx_yyyymmddhhmmss.BIN Event history: EVENTxx_yyyymmddhhmmss.BIN</p> <p>CSV Filename Set at [Format Setting] → [CSV Format Setting] → [File Name]. ALARM_00_00_yyyymmddhhmmss.CSV (default)</p>
Drive for Output	Set the output destination. Storage Setting <sup>*2</sup> C: Built-in Socket D: USB-A Port
Output timing	Set the output timing. Storage Output Bit: Output when the relevant bit turns ON. After Full Capacity At power-on Upon date change Upon change to local mode Upon storage removal <sup>*4</sup>

\*1 Temporary file created during data update. This file is created temporarily only when the [System Setting] → [Unit Setting] → [General Setting] → [Output alarm data in binary format] checkbox is unselected.

\*2 Match with the setting of [System Setting] → [Storage Setting] → [Storage Connection Target].

\*3 If you do not want to create a backup folder, [Do not output backup files] can be selected on the [Others] tab.

\*4 Refers to the operation of a switch for which [Function] is set to [Storage Removal] or [Storage Removal] on the system menu.

### Example of storage output

1. Alarm block number 0, alarm history, output drive (built-in socket), CSV/backup output drive (built-in socket)

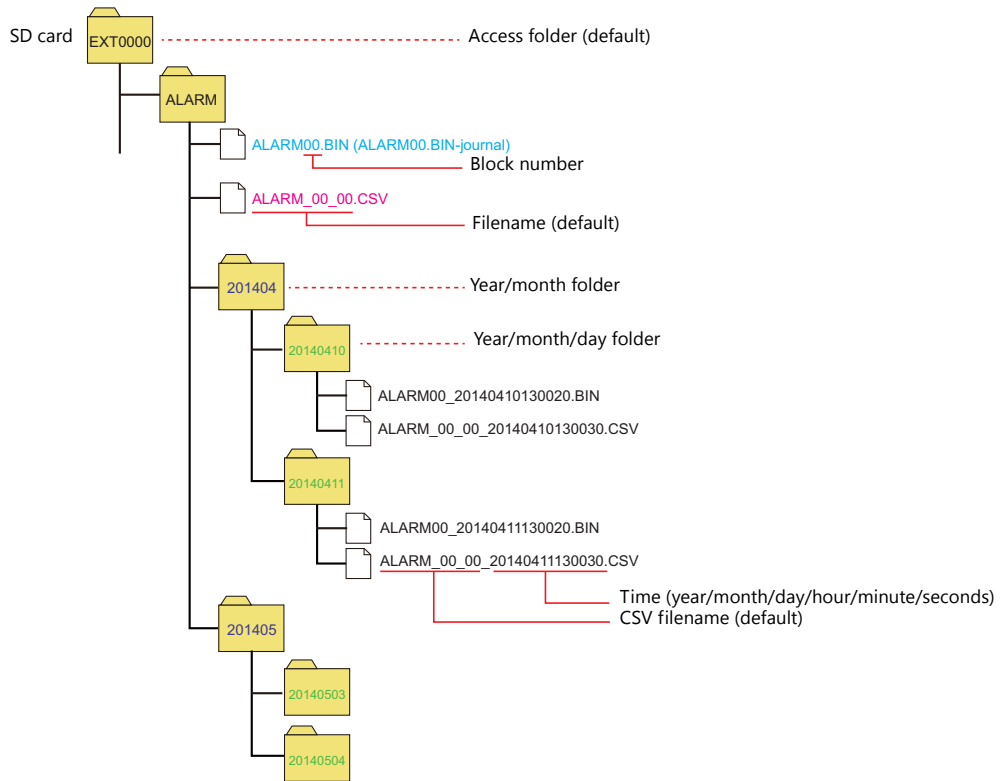

2. Alarm block number 0, alarm history, output drive (built-in socket), CSV/backup output drive (USB-A)

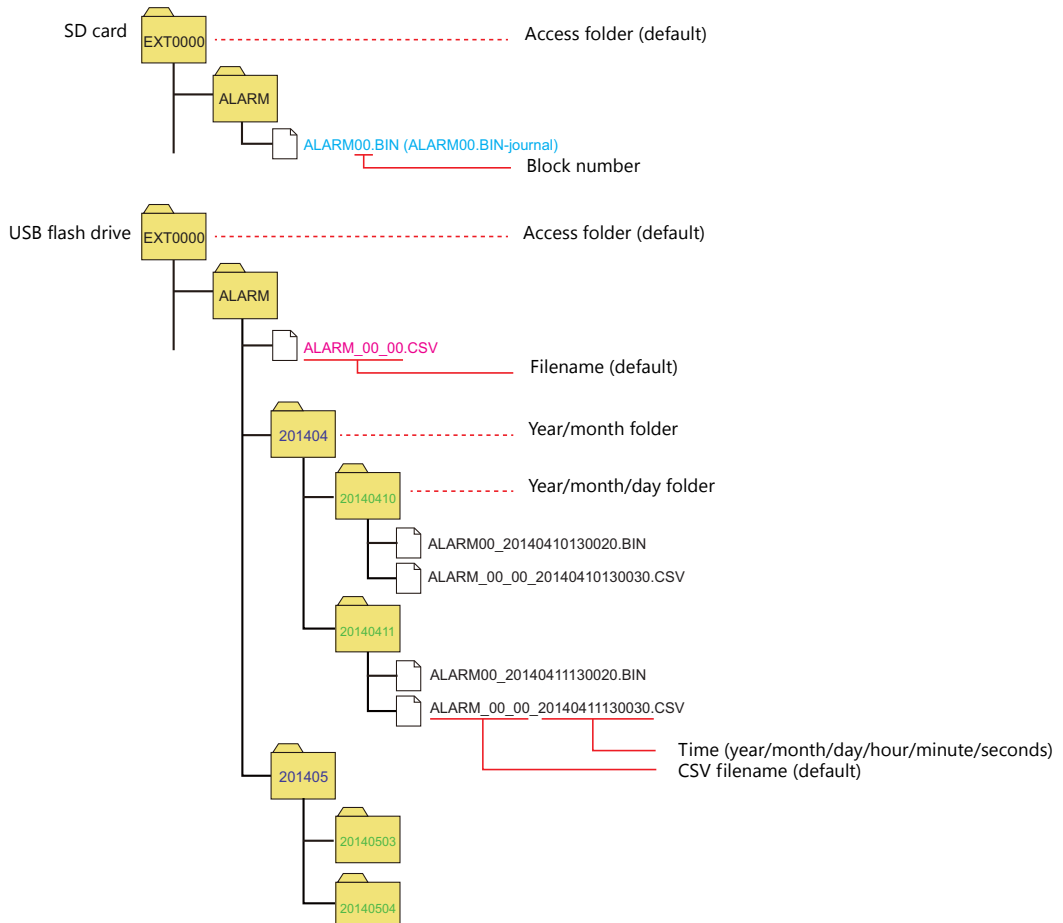

## Control Device Setting

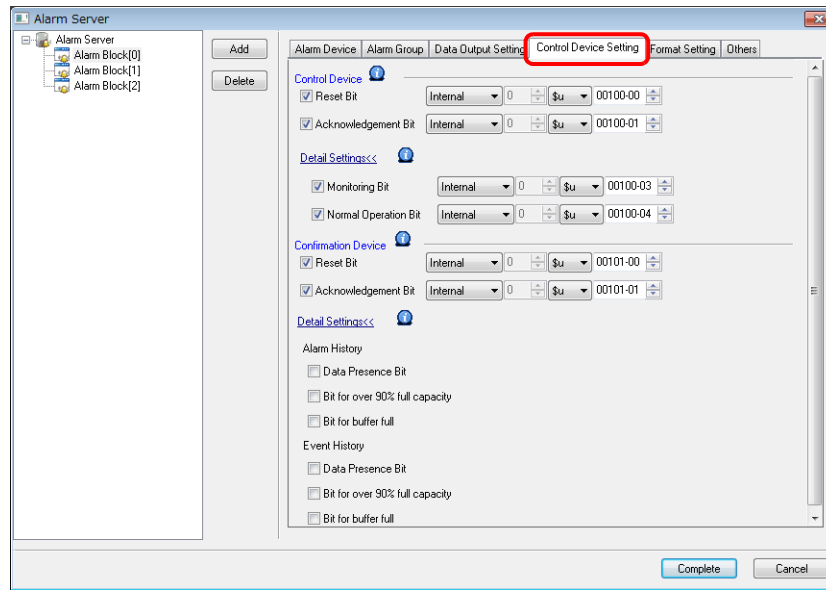

Item	Description
Control Device	Execute resets and storage output using a control device memory.
Reset Bit	Bit OFF → ON: Clears the history data. While bit is ON, saving of history is halted.
Acknowledgment Bit	Bit OFF → ON: Sets an unacknowledged alarm as acknowledged. When multiple V9 series units are connected to a single PLC, using this acknowledgment bit allows the acknowledged state to be updated to all V9 series units.
Storage Output Bit	Bit OFF → ON: Outputs history data to CSV file. The bit device memory setting is configured on the [Data Output Setting] tab window.
Monitoring Bit	Control the start and end of history saving. Bit OFF → ON: Starts monitoring. History is saved when the alarm bit turns ON. Bit ON → OFF: Stops monitoring. History is not saved even if the alarm bit turns ON.  If this bit is not used, history is saved when the alarm bit turns ON/OFF.
Normal Operation Bit	This bit controls the alarm history. While the alarm bit is OFF, this bit is ON. As soon as the alarm bit turns ON, this bit turns OFF. The first error bit that is turned ON while this bit is OFF is recognized as the "primary cause" error, and can be distinguished from the other errors.
Confirmation Device	Output the execution result of the control device memory and other information.
Reset Bit	When the reset bit of the control device memory is ON and reset is completed, this bit turns ON.
Acknowledgment Bit	When the acknowledgment bit of the control device memory changes to 1, this bit turns ON.
Storage Output Bit	When the storage output bit of the control device memory changes to 1, this bit turns ON.
Alarm History	This bit turns ON according to the amount of alarm history save data.  Data Presence Bit: Turns ON when history data exists. Bit for over 90% full capacity: Turns ON when history data takes up 90% of the storage capacity. Bit for buffer full: Turns ON when the storage device is full.
Event History	This bit turns ON according to the amount of event history save data.  Data Presence Bit: Turns ON when history data exists. Bit for over 90% full capacity: Turns ON when history data takes up 90% of the storage capacity. Bit for buffer full: Turns ON when the storage device is full.

## Format Setting

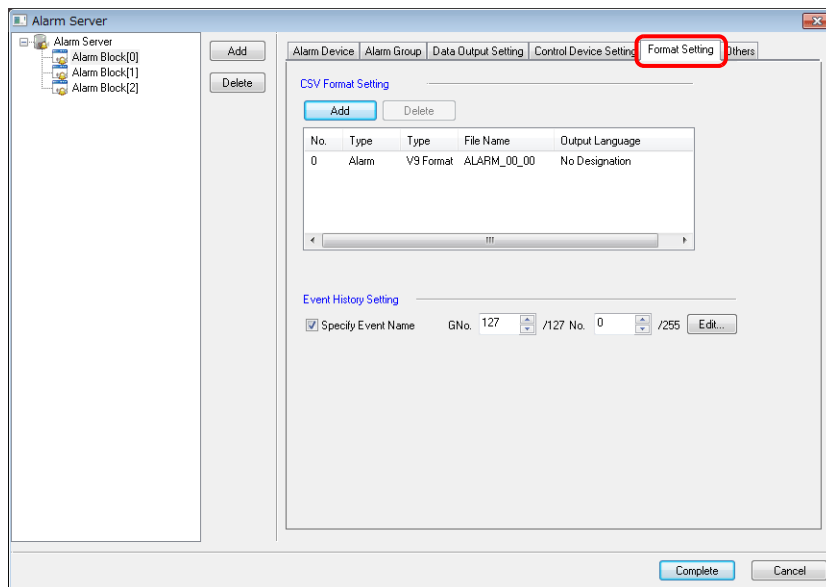

Item		Description
CSV Format Setting		These settings are for saving alarm and event history to CSV files. Multiple CSV formats can be registered using the [Add] button.
Event History Setting	Specify Event Name	Set the message to use for the status display area of the event history part. Display the [Message Edit] window by clicking the [Edit] button. GNo. No.

### CSV format setting

- V9 format

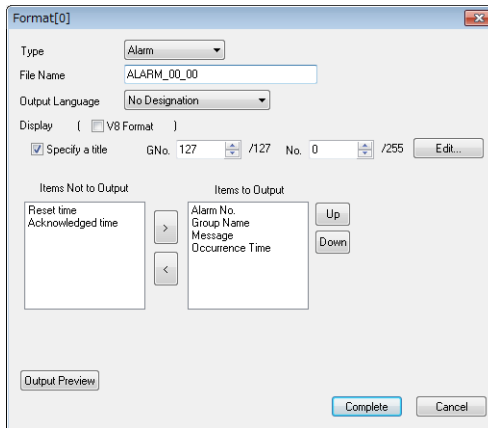

Item		Description
Type		Select the alarm type. Alarm/Event
File Name		Set the name of the CSV file. 1 to 64 one-byte alphanumeric characters  Default ALARM_xx_aa.CSV (xx: block number, aa: format number)
Output Language		Set the language used in the CSV file. No Designation: Output the CSV file using the language displayed on the unit. Language 1 to 16
Display		Set the items and format for CSV file output.  V8 Format: Select this checkbox to output the CSV file in the same format as the V8 series.
	Specify a title	Add a title to each item. Display the [Message Edit] window by clicking the [Edit] button. GNo. No.
	Items Not to Output	Use the [>] and [<] switches to select the items for CSV file output.  Items Not to Output: Not output to CSV file Items to Output: Output to CSV file
	Items to Output	
	> <	

Item	Description
Items to Output Up, Down	Set the display order in the CSV file using the [Up] and [Down] buttons. Items are displayed in left to right order in the CSV file.
Calendar Condition	Set the output condition of the selected items. Date Only/Time Only/Date and Time  Date/Time Display Format Setting Set the date and time display format. Refer to <a href="#">page 8-27</a> .
Output Preview	Check a preview of the CSV file output.

- V8 format  
Select when saving CSV files in the same format as the V8 series.

Alarm

Event

Item	Description
Type	Select the alarm type. Alarm: V8 alarm display format Event: V8 bit sampling format
File Name	Set the name of the CSV file. 1 to 64 one-byte alphanumeric characters  Default ALARM_xx_aa.CSV (xx: block number, aa: format number)
Output Language	Set the language used in the CSV file. No Designation: Output the CSV file using the language displayed on the unit. Language 1 to 16
Display (V8 Format)	Set the items and format for CSV file output.  V8 Format: Select this checkbox to output the CSV file in the same format as the V8 series.
History Display	Select the history data for CSV file output. [Time of Occurrence]/[Occurrence/Cancellation Time]/[Occurrence/Confirmation Time]/ [Occurrence/Cancellation/Confirmation Time]/[Time Lag Display]/ [Total Frequency of Occurrence Display]/[Total Time of Occurrence Display]/ [Time of Occurrence Display]
Calendar Condition	Set the output condition of items shown in [History Display]. Date Only/Time Only/Date and Time  Date/Time Display Format Setting Set the date and time display format. Refer to <a href="#">page 8-27</a> .
Display the primary cause only	Only output history data of primary causes to the CSV file.
Add a (*) mark to the primary cause	Add an asterisk (*) to the left of the primary cause error.
Output Information	Select the status for output to the CSV file. ON-OFF: Output occurrence/cancellation history. ON: Output occurrence history. OFF: Output cancellation history. ON-OFF-CHK: Output occurrence/cancellation/acknowledgment history.
Activate Status Display	Select the status of output information. Display ON/OFF/CHK: Output the bit status as ON/OFF/CHK. Specify Message No.: Output the bit status using a message.

## Others

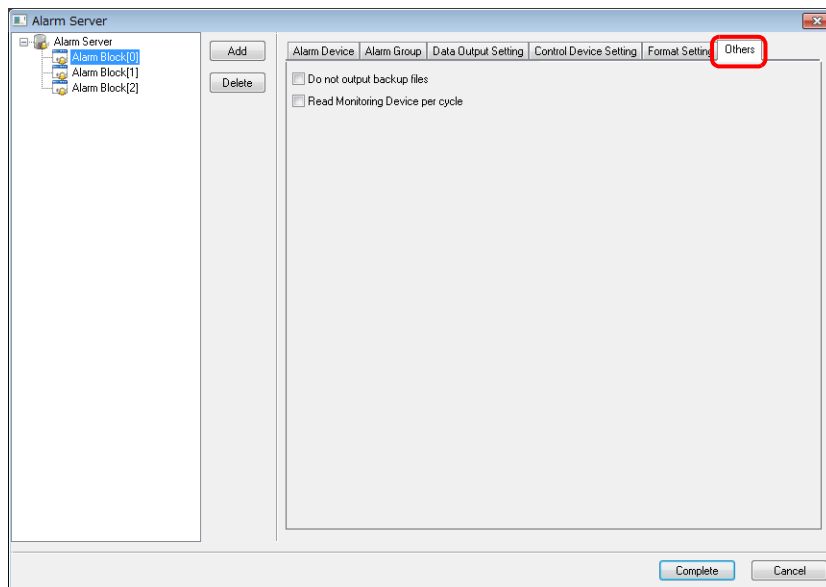

Item	Description
Do not output backup files	No backup folder or file is created. Unselected Create a backup folder. Selected Do not create a backup folder. The files ALARMxx.BIN/EVENTxx.BIN *1 and ALARM_xx_aa.CSV *2 are created in the ALARM folder.
Read Monitoring Device per cycle	Selected Read the alarm device memory according to the communication cycle. Unselected Read the alarm device memory according to [Monitoring Intervals].

\*1 If the setting at [Alarm Server] → [Data Output Setting] → [Storage Output Settings] → [Number of Data to Save] is not configured, ALARMxx.BIN/EVENTxx.BIN files are not created. A CSV file is created from the data saved in the internal storage settings.

\*2 The filename can be changed via [Format Setting] → [File Name].

## 8.2.3 Action When Alarms Occur

In addition to saving history to an alarm server when an alarm occurs, other actions such as displaying a scrolling message or sending e-mails can be added. This section describes the required settings for each action.

### Scrolling Messages

An alarm message is automatically displayed at the bottom (or top) of the screen. It is displayed continually until the error is reset even if the screen is changed over. Once all messages have been scrolled through, the first message is displayed.

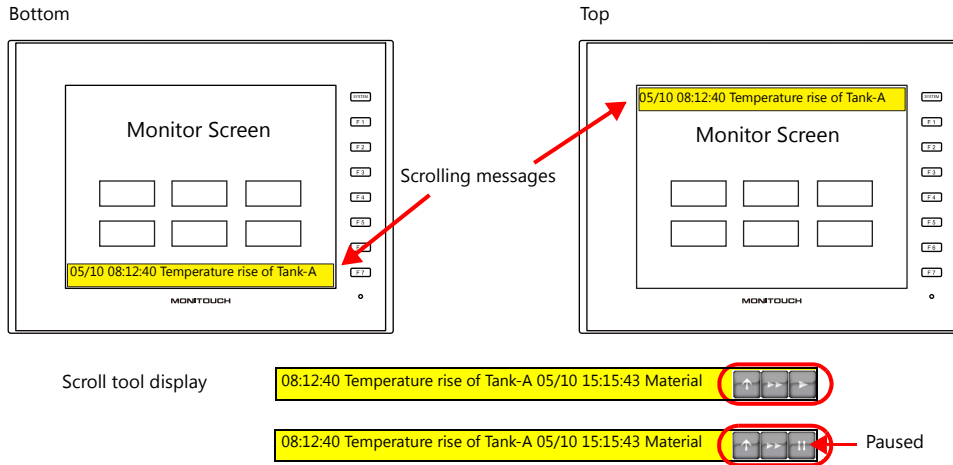

\* Only the first line of scrolling messages is displayed even if two or more lines are set for [Alarm Device] → [Message Lines].

### Settings



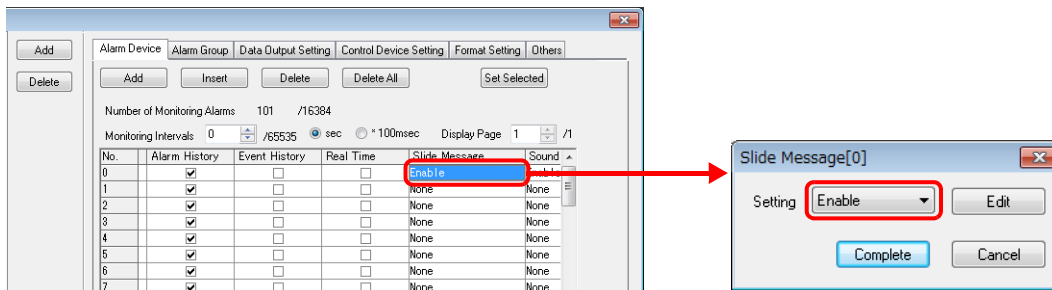



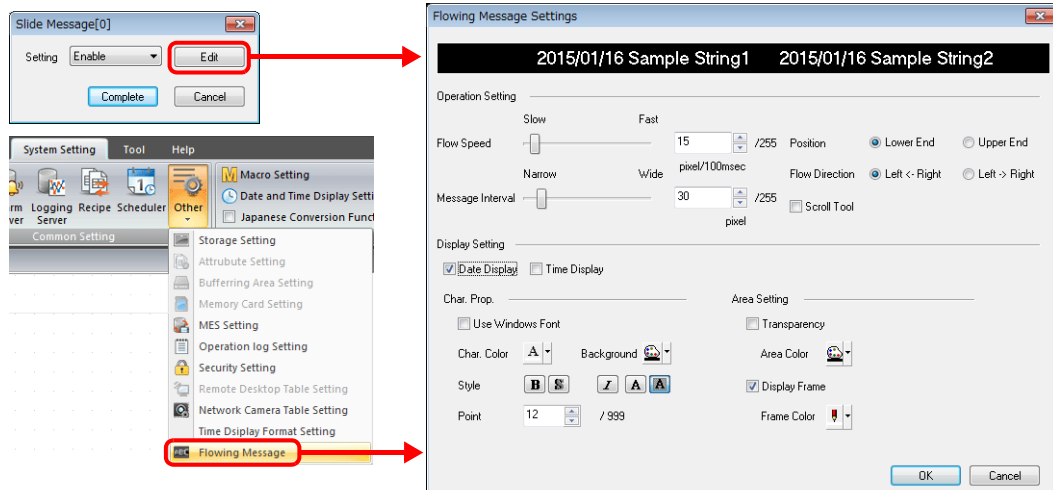

- Alarm block settings  
Select [Enable] for [Alarm Block] → [Alarm Device] → [Slide Message] → [Setting].



- Flowing (scrolling) message settings  
Click the [Edit] button or [System Setting] → [Other] → [Flowing Message].  
Configure the following settings.





Item	Description						
Operation Setting	Flow Speed	Set the message speed. 1 - 255 pixel/100ms					
	Message Interval	Set the interval between multiple scrolling messages.					
	Position	Set the display position of messages. Lower End / Upper End * Scrolling messages can be moved between the top/bottom of the screen in RUN mode by using the "scroll tool".					
	Flow Direction	Set the direction of message scrolling. /Left ← Right / Left → Right					
	Scroll Tool	Display the scroll tool when the message area is tapped. The scroll tool can be used to change the display position and speed. <table border="1" style="width: 100%; margin-top: 10px;"> <tr> <td style="text-align: center;"></td> <td>Moves the display position.</td> </tr> <tr> <td style="text-align: center;"></td> <td>Scrolling occurs at double speed while the switch is pressed.</td> </tr> <tr> <td style="text-align: center;"></td> <td>Stop scrolling. Tap a stopped message to manually scroll left or right.</td> </tr> </table>		Moves the display position.		Scrolling occurs at double speed while the switch is pressed.	
	Moves the display position.						
	Scrolling occurs at double speed while the switch is pressed.						
	Stop scrolling. Tap a stopped message to manually scroll left or right.						
Display Setting	Date Display	Display the date of alarm occurrence. *1					
	Time Display	Display the time of alarm occurrence. *1					
Char. Prop.	Use Windows Font	Displays with the [Windows Font] setting set in the [Char. Prop.] window accessible in the [Message Edit] window.					
	Char. Color Background Style Point	Set the text color, background color, style, and point size of scrolling messages.					
Area Setting	Transparency Area Color	Set the area color. The area can be made transparent.					
	Display Frame Frame Color	Add a frame to the area. The frame color can also be set.					

- \*1 The time of scrolling messages is referenced from the internal clock of the V9 series unit and not the history time on the alarm server. If power to the V9 series unit is turned off and on again or the screen is switched to Local mode while a scrolling message is displayed, the time is updated to when switched to RUN mode.
- \*2 Only [Windows Font] properties in the [Char. Prop.] window accessible from the [Message Edit] window are available. The other [Color]/[Point] settings are unavailable.

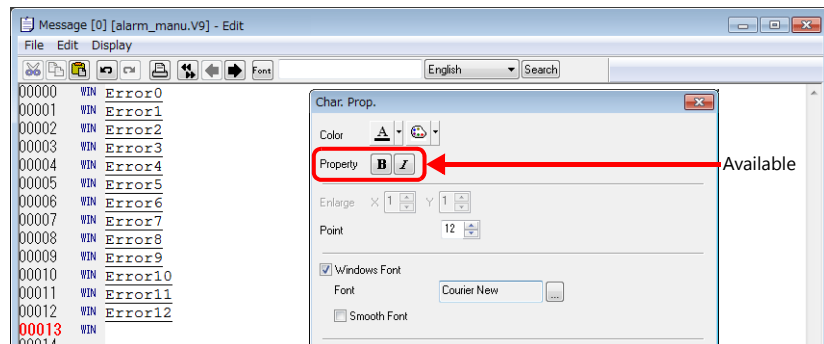

## Playing Sounds

Play back an audio file. Audio can be played back continuously while an alarm is occurring.

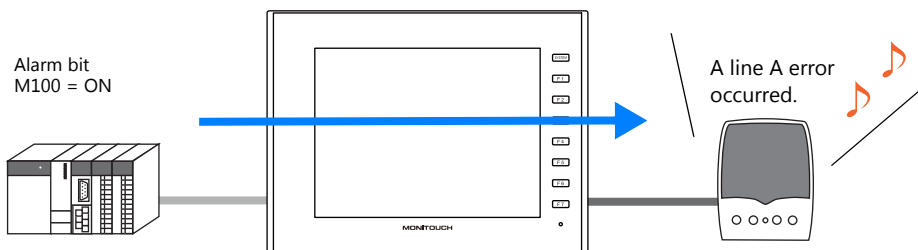

## Supported models

V9 Standard (AUDIO output connector)

Connection to an amplifier and external speaker is required.

## Settings

- Double-click [Alarm Block] → [Alarm Device] → [Sound].  
Configure the following settings.

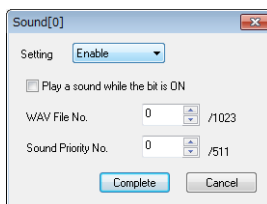

Item	Description
Setting	Enabled
Play a sound while the bit is ON	Continuously play back the audio file.
WAV File No.	Set the WAV file number from number 0000 to 1023. The names of audio files that can be played are formatted as "WAxxxx.wav" (xxxx: 0000 to 1023).
Sound Priority No. <sup>*1</sup>	Set the priority of the WAV file.

<sup>\*1</sup> Audio priority  
When multiple errors occur, the WAV file with the highest priority is played.  
If multiple errors with the same priority occur, the audio file of the last error to occur is played.

## E-mail Notification

Send an e-mail when an error occurs. When using a multi-language screen, e-mails are sent in all languages.

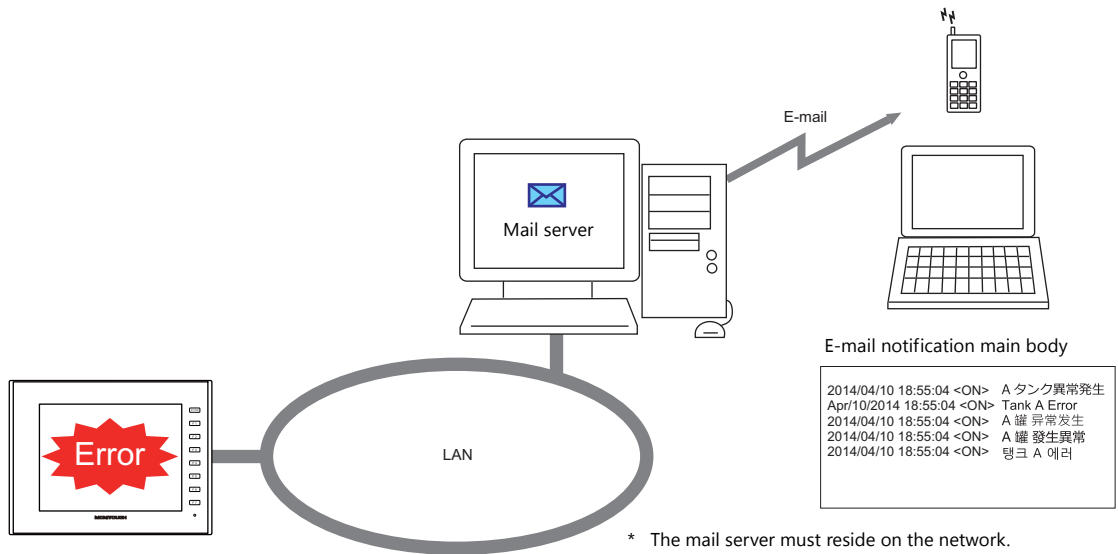

## Settings

- Double-click [Alarm Block] → [Alarm Device] → [E-Mail].  
Configure the following settings.

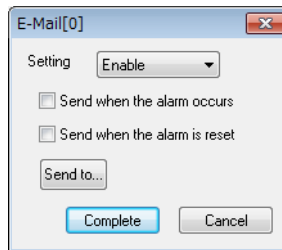

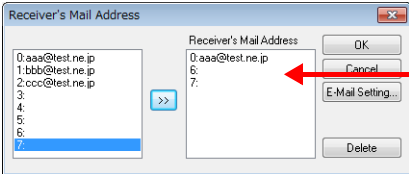
Item	Description
Setting	Enable
Send when the alarm occurs	Send an e-mail notification when an error occurs.
Send when the alarm is reset	Send an e-mail notification when the system recovers from an error.
Send to	Select the recipient mail addresses. 
* When creating screens and the recipients of e-mail notification is yet to be determined, dummy recipients from numbers 0 to 8 can be used instead. The actual recipient addresses can be registered later on the V9 series unit in the [E-Mail Setting] in Local mode.	

- E-mail settings  
Configure the mail server settings. There are two ways to configure mail server settings: using the V-SFT editor or on the V9 series unit.

 Refer to "6.8 E-mail Notification" in the V9 Series Reference Manual 2.

## Operation Setting

Double-click [Alarm Block] → [Alarm Device] → [Operation Setting].

Perform operations including writing to the specified device memory address (output setting), screen changeover / overlap control (function), and macro execution (macro).

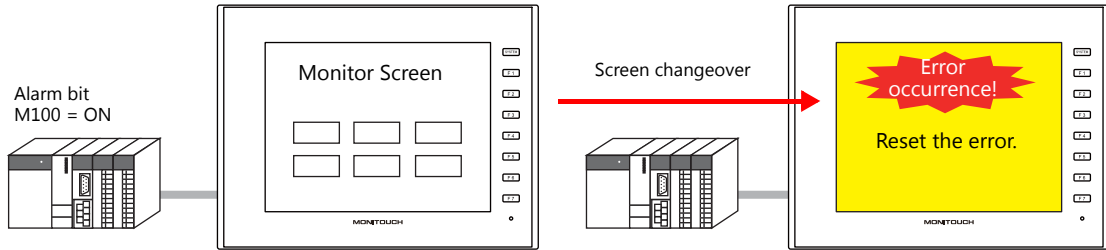

## Output setting

Turn the output device ON or OFF or write data when an alarm occurs or is canceled.

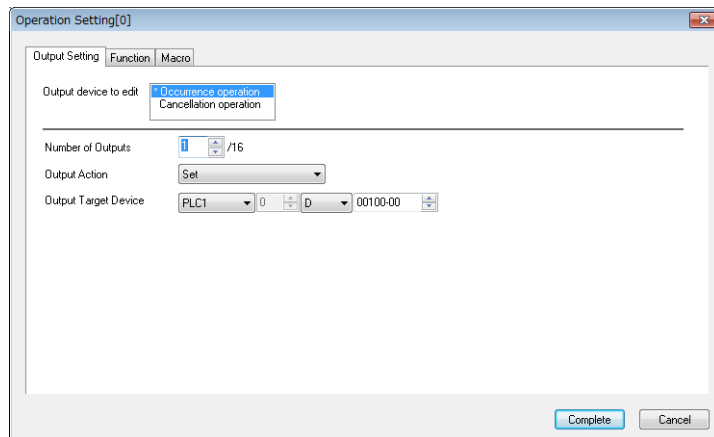

Item		Description															
Output device to edit	Occurrence operation	Set the output operation to perform when an alarm occurs.															
	Cancellation operation	Set the output operation to perform when an alarm is canceled.															
Number of Outputs	0	No output operation															
	1 - 16	Output operation performed Set the required items according to the output operation.															
		<table border="1"> <thead> <tr> <th>Output Action</th> <th>Output Target Device</th> <th>Inversion Time</th> <th>Data Length Write Value</th> </tr> </thead> <tbody> <tr> <td>Set Reset Alternate</td> <td rowspan="2">Output bit</td> <td>-</td> <td>-</td> </tr> <tr> <td>Momentary (ON) Momentary (OFF)</td> <td>100ms - 3s Bit returns to original value after inversion time elapses.</td> <td>-</td> </tr> <tr> <td>Writing in Words</td> <td>Output device</td> <td>-</td> <td>1-Word/2-Word Value to write</td> </tr> </tbody> </table>	Output Action	Output Target Device	Inversion Time	Data Length Write Value	Set Reset Alternate	Output bit	-	-	Momentary (ON) Momentary (OFF)	100ms - 3s Bit returns to original value after inversion time elapses.	-	Writing in Words	Output device	-	1-Word/2-Word Value to write
Output Action	Output Target Device	Inversion Time	Data Length Write Value														
Set Reset Alternate	Output bit	-	-														
Momentary (ON) Momentary (OFF)		100ms - 3s Bit returns to original value after inversion time elapses.	-														
Writing in Words	Output device	-	1-Word/2-Word Value to write														

## Function

Perform screen changeover / overlap control when an alarm occurs or is canceled.

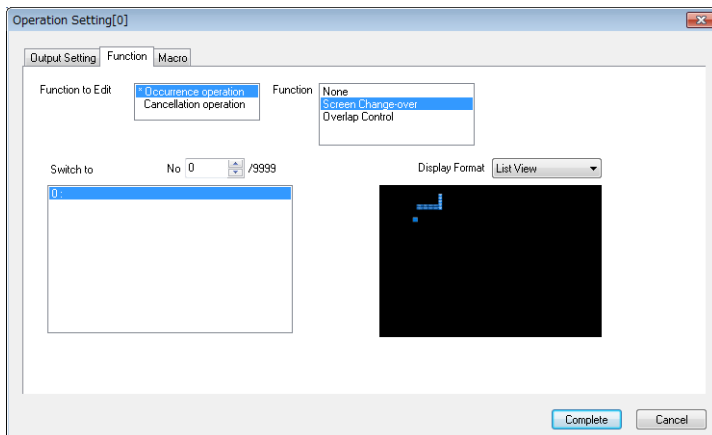

Item		Description
Function to Edit	Occurrence operation	Set the function used when an alarm occurs.
	Cancellation operation	Set the function used when an alarm is canceled.
Function	None	No function
	Screen Changeover	Perform screen changeover automatically. Set [Switch to] and [List View] or [Thumbnail].
	Overlap Control	Display a global overlap. Set [Global Overlap ID] and [Overlap Library No.].

## Macro

Execute a macro when an error occurs or is canceled.

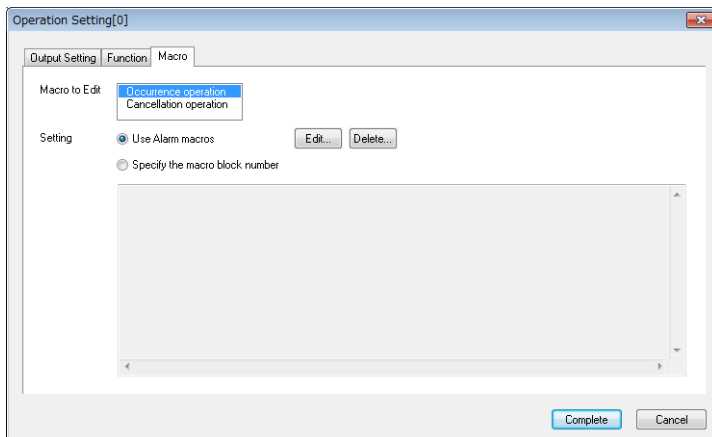

Item		Description
Macro to Edit	Occurrence operation	Set the macro to execute when an alarm occurs.
	Cancellation operation	Set the macro to execute when an alarm is canceled.
Setting	Use Alarm macros	Register a macro via the [Edit] button.
	Specify the macro block number	Specify the macro block number.

## Parameters

When an alarm occurs, the data (parameters) associated with the alarm can be saved/displayed together with an alarm message. Logging the history of such alarm-relevant parameters will make it easier to locate and investigate the causes of alarms.

Thermal error

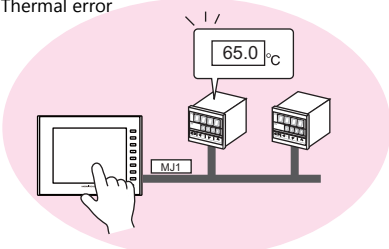

Material shortage

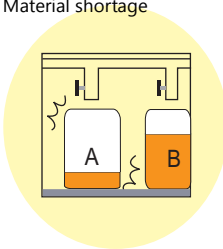

Worker change

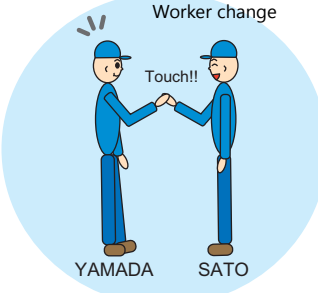

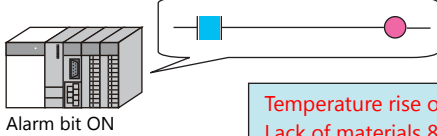

Temperature rise of Tank-A 65°C	14/05/10	08:12:40	↑
Lack of materials 80 g	14/05/10	15:15:43	
Worker change Worker: Yamada → Sato	14/05/10	17:00:00	
Abnormality of conveyor A-Line	14/05/10	19:59:15	↓

## Settings

- Double-click [Alarm Block] → [Alarm Device] → [Parameter].  
Configure the following settings.

Parameter table

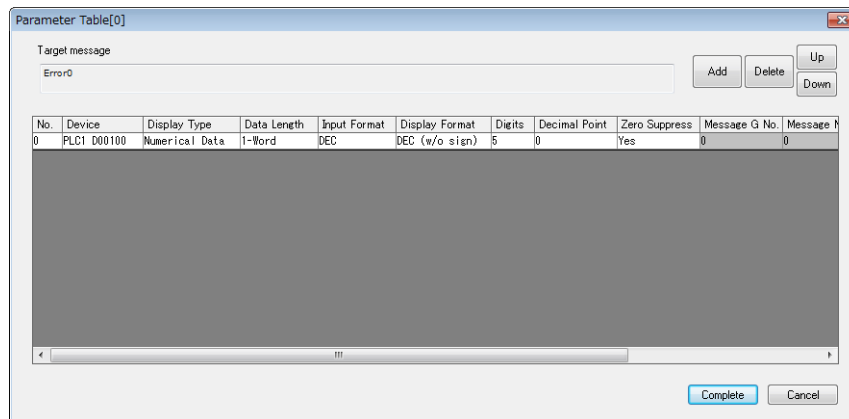

Item	Description
Parameter table number 0 to 7	Create parameters with the [Add] button. Up to 8 parameters can be registered per alarm device memory address.
Add	Add a new parameter.
Delete	Delete the selected parameter.
Up/Down	Change the order of parameters.
Device	Set the parameter device memory address.

Item	Description																
Display Type	Set the display type of the parameter and other related items.																
Numerical Data	Save/display the data value of the device memory. The following settings are required. <table border="1" style="width: 100%; border-collapse: collapse;"> <thead> <tr> <th>Item</th> <th>Setting Value</th> </tr> </thead> <tbody> <tr> <td>Data Length</td> <td>1-Word/2-Word</td> </tr> <tr> <td>Input Format</td> <td>DEC/BCD/FLOAT</td> </tr> <tr> <td>Display Format</td> <td>DEC (w/o sign)/DEC (with sign -) DEC (with sign +)/HEX/OCT/ BIN (binary)</td> </tr> <tr> <td>Digits</td> <td>1 - 32</td> </tr> <tr> <td>Decimal Point</td> <td>0 - 31</td> </tr> <tr> <td>Zero Suppress</td> <td>Yes/None</td> </tr> <tr> <td>Char. Place</td> <td>Flush Right/Flush Left</td> </tr> </tbody> </table>	Item	Setting Value	Data Length	1-Word/2-Word	Input Format	DEC/BCD/FLOAT	Display Format	DEC (w/o sign)/DEC (with sign -) DEC (with sign +)/HEX/OCT/ BIN (binary)	Digits	1 - 32	Decimal Point	0 - 31	Zero Suppress	Yes/None	Char. Place	Flush Right/Flush Left
Item	Setting Value																
Data Length	1-Word/2-Word																
Input Format	DEC/BCD/FLOAT																
Display Format	DEC (w/o sign)/DEC (with sign -) DEC (with sign +)/HEX/OCT/ BIN (binary)																
Digits	1 - 32																
Decimal Point	0 - 31																
Zero Suppress	Yes/None																
Char. Place	Flush Right/Flush Left																
Text	Save/display text set at the device memory address. The following settings are required. <table border="1" style="width: 100%; border-collapse: collapse;"> <thead> <tr> <th>Item</th> <th>Setting Value</th> </tr> </thead> <tbody> <tr> <td>Data Length</td> <td>1-Word/2-Word</td> </tr> <tr> <td>Characters</td> <td>1 - 127</td> </tr> <tr> <td>Text Process</td> <td>LSB → MSB / MSB → LSB</td> </tr> </tbody> </table>	Item	Setting Value	Data Length	1-Word/2-Word	Characters	1 - 127	Text Process	LSB → MSB / MSB → LSB								
Item	Setting Value																
Data Length	1-Word/2-Word																
Characters	1 - 127																
Text Process	LSB → MSB / MSB → LSB																
Message No.	Specify a message number (absolute address) for the device memory address and save/display the corresponding message. The following settings are required. <table border="1" style="width: 100%; border-collapse: collapse;"> <thead> <tr> <th>Item</th> <th>Setting Value</th> </tr> </thead> <tbody> <tr> <td>Data Length</td> <td>1-Word/2-Word</td> </tr> <tr> <td>Input Format</td> <td>DEC / BCD</td> </tr> </tbody> </table>	Item	Setting Value	Data Length	1-Word/2-Word	Input Format	DEC / BCD										
Item	Setting Value																
Data Length	1-Word/2-Word																
Input Format	DEC / BCD																
Bit	In the bit state when an error occurs, save/display the corresponding message. Bit ON: Save the message of [Message G No.] and [Message No.]. Bit OFF: Save the message of [Message G No.] and [Message No. + 1]. The following settings are required. <table border="1" style="width: 100%; border-collapse: collapse;"> <thead> <tr> <th>Item</th> <th>Setting Value</th> </tr> </thead> <tbody> <tr> <td>Message G No.</td> <td>0 - 127</td> </tr> <tr> <td>Message No.</td> <td>0 - 255</td> </tr> </tbody> </table>	Item	Setting Value	Message G No.	0 - 127	Message No.	0 - 255										
Item	Setting Value																
Message G No.	0 - 127																
Message No.	0 - 255																

- Editing messages  
Register parameter numbers into alarm messages.

**%PXS**  
└─ 0 - 7

Specify parameter numbers registered in the [Parameter Table] window.

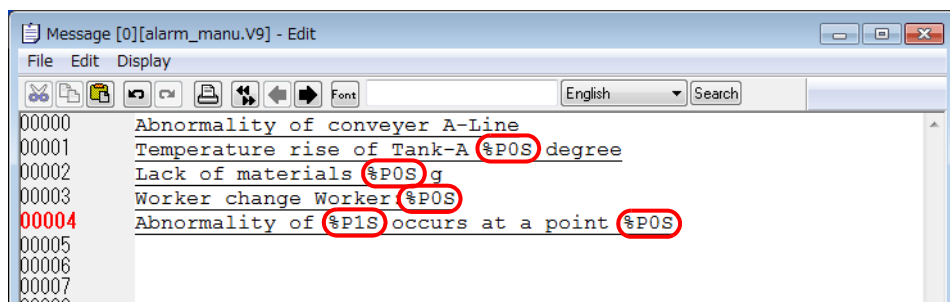

## Touch Action

Tap the message on the alarm part to changeover the screen. This displays more detailed alarm information.

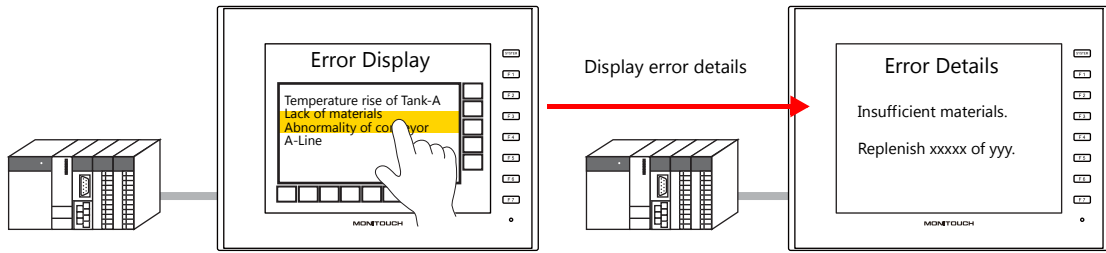

## Settings

- Double-click [Alarm Block] → [Alarm Device] → [Touch Action].  
Configure the following settings.

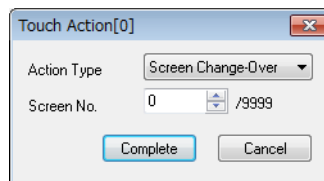

Item	Description
Action Type	Screen changeover
Screen No.	Set a screen number from 0 to 9999.

- Alarm part settings window → [Detail]

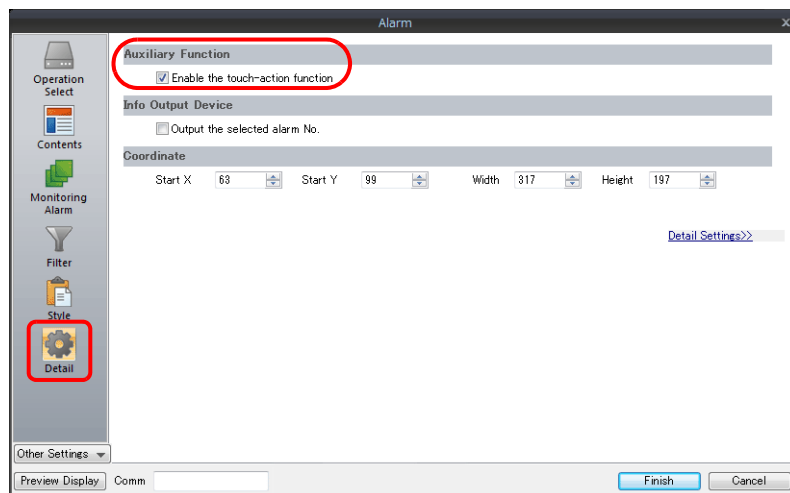

Item	Description
Auxiliary Function	Enable the touch-action function Unselected: Tapping a message does not changeover the screen. Selected: Tapping a message changes over the screen.



## 8.3 Date and Time Display Setting

Set the date and time format used by alarm parts, alarm CSV output, scrolling messages, and e-mail. When using multi-language screens, a format for each language can be set.

Configure settings at [System Setting] → [Setting] → [Date and Time Display Setting].

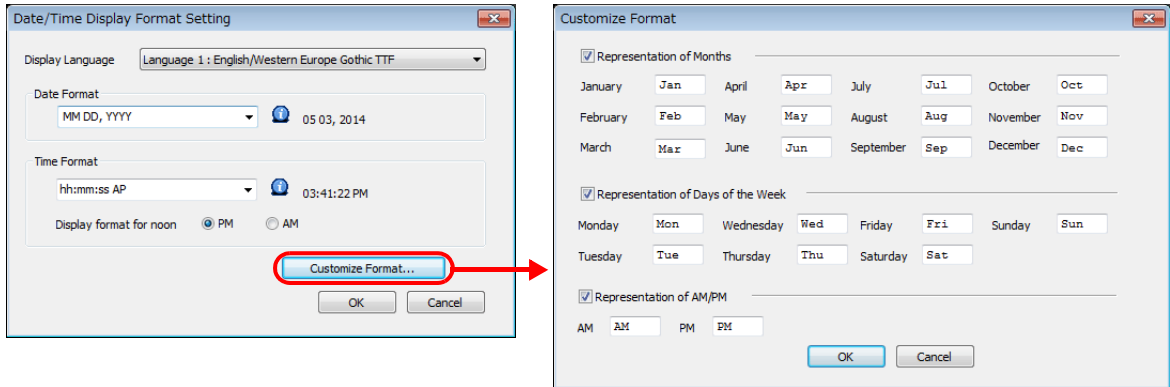

Item	Description																						
Display Language	Select a language. Language 1 to 16																						
Date Format	Set the date format. To use a format other than those provided, enter the format directly. <table border="1" style="margin-top: 10px;"> <tr> <td rowspan="2">Year</td> <td>YYYY</td> <td>4 digits</td> </tr> <tr> <td>YY</td> <td>2 digits (00 to 99)</td> </tr> <tr> <td rowspan="3">Month</td> <td>MM</td> <td>01 - 12</td> </tr> <tr> <td>M</td> <td>1 - 12</td> </tr> <tr> <td>MMM</td> <td>Customized format <sup>*1</sup></td> </tr> <tr> <td rowspan="2">Day</td> <td>DD</td> <td>01 - 31</td> </tr> <tr> <td>D</td> <td>1 - 31</td> </tr> <tr> <td>Day of the week</td> <td>DDD</td> <td>Customized format <sup>*2</sup></td> </tr> </table>	Year	YYYY	4 digits	YY	2 digits (00 to 99)	Month	MM	01 - 12	M	1 - 12	MMM	Customized format <sup>*1</sup>	Day	DD	01 - 31	D	1 - 31	Day of the week	DDD	Customized format <sup>*2</sup>		
Year	YYYY		4 digits																				
	YY	2 digits (00 to 99)																					
Month	MM	01 - 12																					
	M	1 - 12																					
	MMM	Customized format <sup>*1</sup>																					
Day	DD	01 - 31																					
	D	1 - 31																					
Day of the week	DDD	Customized format <sup>*2</sup>																					
Time Format	Set the time format. To use a format other than those provided, enter the format directly. <table border="1" style="margin-top: 10px;"> <tr> <td rowspan="4">Hour</td> <td>hh</td> <td>00 - 12</td> <td rowspan="2">Minute</td> <td>mm</td> <td>00 - 59</td> </tr> <tr> <td>h</td> <td>0 - 12</td> <td>m</td> <td>0 - 59</td> </tr> <tr> <td>HH</td> <td>00 - 23</td> <td rowspan="2">Second</td> <td>ss</td> <td>00 - 59</td> </tr> <tr> <td>H</td> <td>0 - 23</td> <td>s</td> <td>0 - 59</td> </tr> <tr> <td>AM/PM</td> <td>AP</td> <td>AM/PM <sup>*3</sup></td> </tr> </table>	Hour	hh	00 - 12	Minute	mm	00 - 59	h	0 - 12	m	0 - 59	HH	00 - 23	Second	ss	00 - 59	H	0 - 23	s	0 - 59	AM/PM	AP	AM/PM <sup>*3</sup>
Hour	hh		00 - 12	Minute		mm	00 - 59																
	h		0 - 12		m	0 - 59																	
	HH		00 - 23	Second	ss	00 - 59																	
	H	0 - 23	s		0 - 59																		
AM/PM	AP	AM/PM <sup>*3</sup>																					
Display format for noon	Set the noon display format. PM: PM12:00 AM: AM12:00																						
Customize Format	Customize the format of month (MMM), weekday (DDD), and AM/PM. <table border="1" style="margin-top: 10px;"> <tr> <td>Representation of Months</td> <td>Set when using characters instead of numbers for the month display. <sup>*1</sup></td> </tr> <tr> <td>Representation of Days of the Week</td> <td>Set when displaying days of the week. <sup>*2</sup></td> </tr> <tr> <td>Representation of AM/PM</td> <td>Set when changing the AM/PM display. <sup>*3</sup></td> </tr> </table>	Representation of Months	Set when using characters instead of numbers for the month display. <sup>*1</sup>	Representation of Days of the Week	Set when displaying days of the week. <sup>*2</sup>	Representation of AM/PM	Set when changing the AM/PM display. <sup>*3</sup>																
Representation of Months	Set when using characters instead of numbers for the month display. <sup>*1</sup>																						
Representation of Days of the Week	Set when displaying days of the week. <sup>*2</sup>																						
Representation of AM/PM	Set when changing the AM/PM display. <sup>*3</sup>																						

<sup>\*1</sup> Default values for month format display (MMM)

Month	English Baltic	Japanese	Simplified Chinese Traditional Chinese	Korean	Central Europe	Cyrillic	Greek	Turkish
Jan			Jan			январь	Γαν	Oca
Feb			Feb			февр	Φεβρ	Şub
Mar			Mar			март	Μάρτ	Mar
Apr			Apr			апр	Άπρ	Nis
May			May			май	Μάιος	May
Jun			Jun			июнь	Ιούν	Haz



Month	English Baltic	Japanese	Simplified Chinese Traditional Chinese	Korean	Central Europe	Cyrillic	Greek	Turkish
Jul			Jul			июль	Ιούλ	Tem
Aug			Aug			авг	Αύγ	Ağu
Sep			Sep			сент	Σεπτ	Eyl
Oct			Oct			окт	Όκτ	Eki
Nov			Nov			ноябрь	Νοέμ	Kas
Dec			Dec			дек	Δεκ	Ara

\*2 Default values for days of the week display (DDD)

Day of the week	English Baltic	Japanese	Simplified Chinese Traditional Chinese	Korean	Central Europe	Cyrillic	Greek	Turkish
Mon	Mon	月	星期二	월요일	Mon	пн	Δευ	Ptesi
Tue	Tue	火	星期三	화요일	Tue	вт	Τρι	Salı
Wed	Wed	水	星期四	수요일	Wed	ср	Τετ	ar
Thu	Thu	木	星期五	목요일	Thu	чт	Πεμ	Per
Fri	Fri	金	星期六	금요일	Fri	пт	Παρ	Cuma
Saturday	Sat	土	星期日	토요일	Sat	сб	Σαβ	C.tesi
Sunday	Sun	日	星期一	일요일	Sun	вс	Κυρ	Paz

\*3 Default values for AM/PM display

AM/PM	English Baltic	Japanese	Simplified Chinese Traditional Chinese	Korean	Central Europe	Cyrillic	Greek	Turkish
AM	AM	午前	上午	오전	AM	AM	am	AM
PM	PM	午後	下午	오후	PM	PM	pm	PM

### Setting example

- Date Format

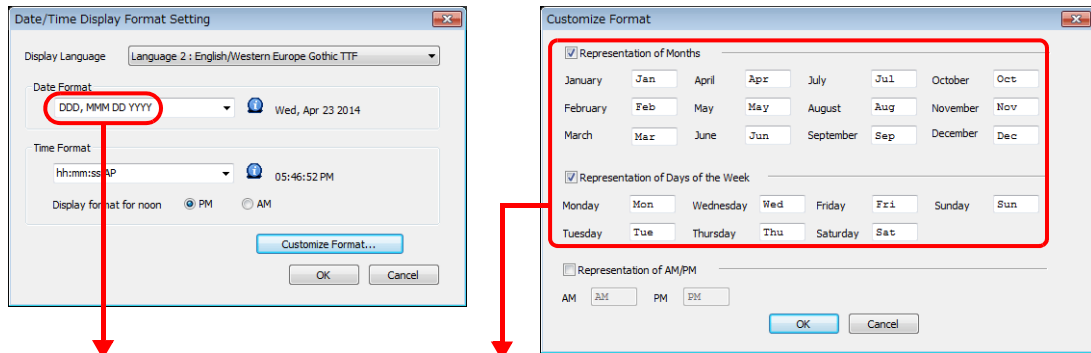

Date Format	Customize Format	Display on MONITOUCH
MMM DD YYYY	[Representation of Months] selected (default)	May 15 2014
DDD, MMM DD YYYY	[Representation of Months] selected (default) [Representation of Days of the Week] selected (default)	Thu, May 15 2014

## 8.4 Alarm Parts

Place an alarm part for checking history saved to an alarm server on MONITOUCH.  
An alarm part can be placed by clicking [Parts] → [Alarm].

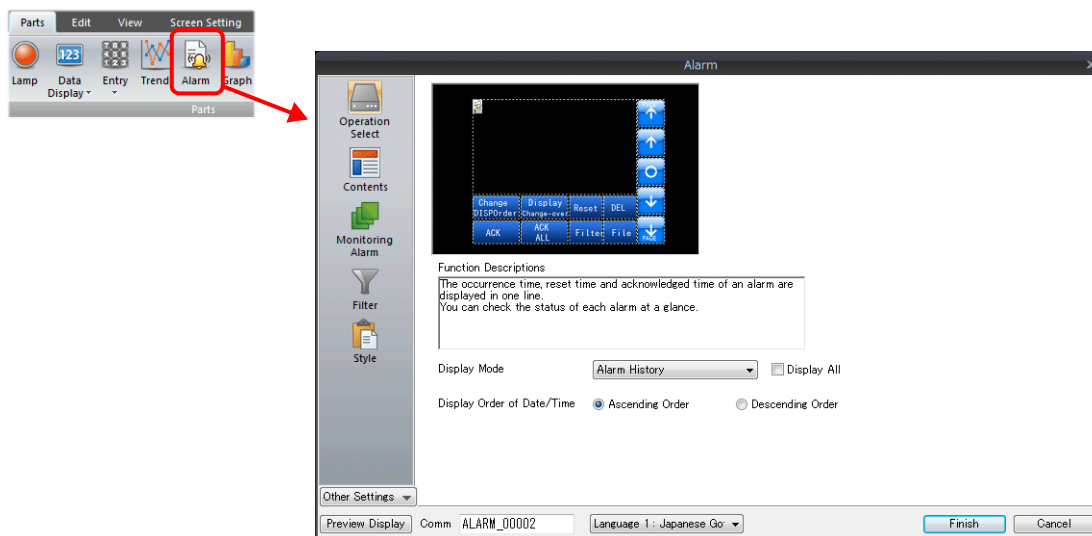

### 8.4.1 Detailed Settings

#### Operation Select

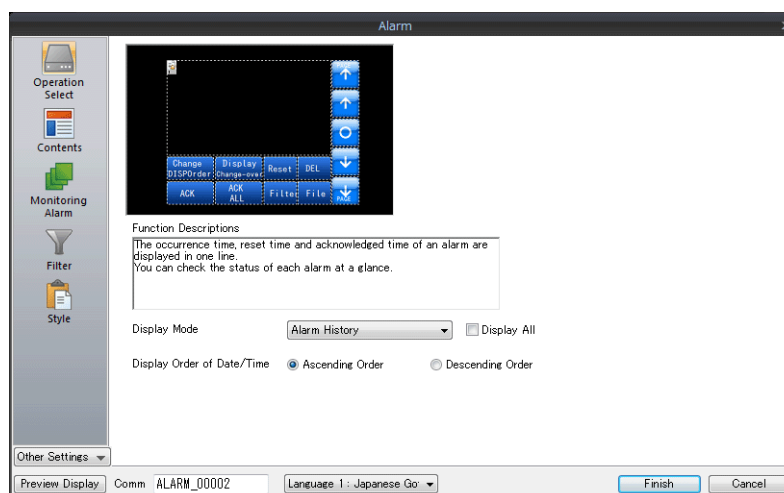

Item	Description
Display Mode	Display history data stored on an alarm server on MONITOUCH. The display on MONITOUCH differs depending on the display mode.
Alarm History	Display alarm occurrence, cancellation, and acknowledgment times on one line. The state of each alarm can be checked at a glance.
Event History	Alarm occurrence, reset, and acknowledged times are each displayed on one line.
Real Time	Only display alarms that are currently occurring. Alarms that require canceling can be checked at a glance.
Alarm Tracking (V8)	This is selected when using a screen program converted from the V8 series. The menu changes to a V8-compatible parts menu.
Alarm Logging (V8)	
Time Order Alarming (V8)	These options are displayed when the [Display All] checkbox is selected.
Bit Order Alarming (V8)	
Display Order of Date/Time	Set the display order of error messages.
Ascending Order	Display in the order of old errors → new errors.
Descending Order	Display in the order of new errors → old errors.

## Contents

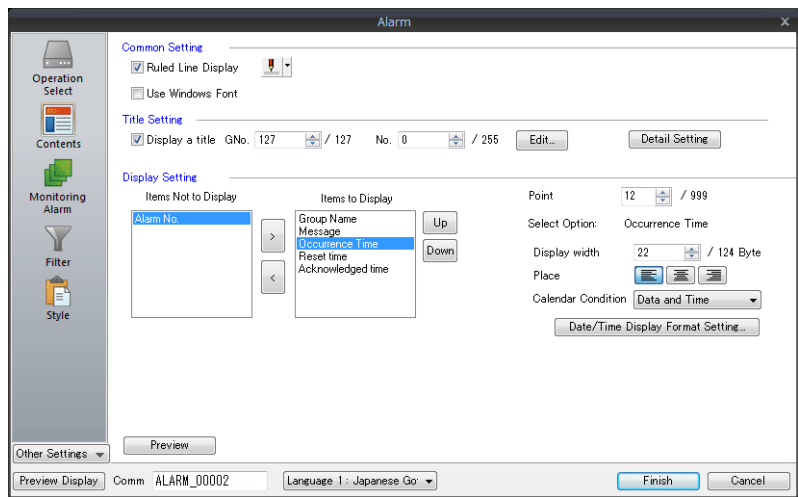

Item		Description	
Common Setting	Ruled Line Display	Display ruled lines in the display area. The color of ruled lines can also be set.	
	Use Windows Font	Display alarm messages using a Windows font. Windows font type, size, and color settings are configured at [Home] → [Registration Item] → [Message].	
Title Setting	Display a title	Display a title for each item in the display area.	
	Edit	Titles can be edited by opening the [Message Edit] window. Use the same number of consecutive lines as the number of items to display.	
	Detail Setting	Set the number of points, display position, and color of titles.	
Display Setting	Items Not to Display	Use the [>] and [<] switches to select the items for display on MONITOUCH.	
	Items to Display	Items Not to Display: Not displayed on MONITOUCH. Items to Display: Displayed on MONITOUCH.	
	Up, Down	Set the display order of items on MONITOUCH using the [Up] and [Down] switches. Items are displayed from left to right on MONITOUCH.	
	Point	Set the text size.	
	Select Option	Display Width	Set the display width of the items selected for display. When a message is longer than the display area width, automatic scrolling is performed while the message is selected by the cursor so that the entire message can be displayed. *1
		Place	Set the display position of the items selected for display.
		Calendar Condition	Set the display state of the items selected for display. Date Only/Time Only/Date and Time
	Date/Time Display Format Setting Set the date and time display format. Refer to <a href="#">page 8-27</a> .		
Preview	Check a preview of the display on MONITOUCH.		

\*1 The [System Setting] → [Unit Setting] → [General Setting] → [Activate auto-scroll display of the alarm] checkbox must be selected. (Default: selected)

## Monitoring Alarm

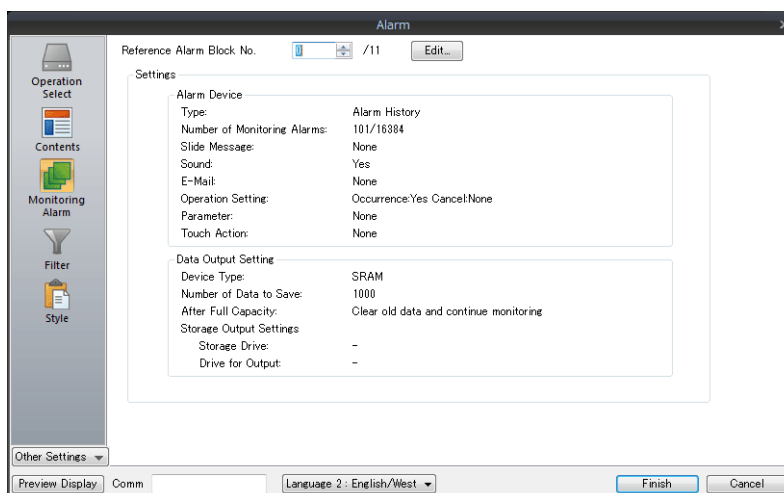

Item	Description
Reference Alarm Block No.	Set the alarm block number for displaying history data. The editing window for alarm blocks can be displayed using the [Edit] button.
Settings	The settings of the selected alarm block can be checked in this area.

## Filter

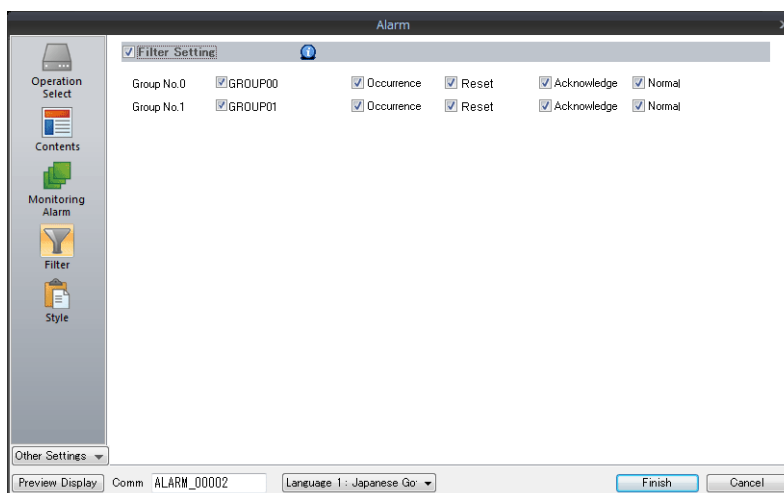

Item	Description
Filter Setting	Set the display state immediately following a screen changeover. Filter settings are not required when displaying all history information. * Filter settings can be changed on MONITOUCH in RUN mode.
Group No. 0 to 15 Occurrence Reset Acknowledge Normal	Selected: Display on MONITOUCH. Unselected: Do not display on MONITOUCH.

## Style

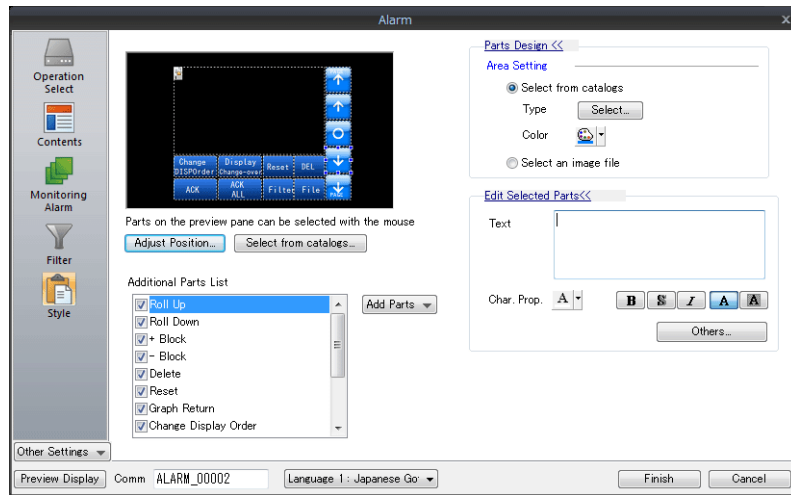

Item	Description										
Additional Parts List	Displays a list of alarm-related parts. Selected: Displayed on MONITOUCH. Unselected: Not displayed on MONITOUCH. Parts can be added to the list by clicking [Add Parts].										
Roll Up	Scrolls the display up by one page.										
Roll Down	Scrolls the display down by one page.										
+ Block	Move the cursor to the next item.										
- Block	Move the cursor to the previous item.										
Delete	Delete the selected message. * The message is only erased from display on MONITOUCH and it remains in the history data.										
Reset	Clear the history data on the alarm server. Press this switch once to activate it and press it again within 2 seconds to clear the data. If the switch is not pressed again within two seconds, the switch's lamp turns off and resetting is nullified.										
Graph Return	This switch blinks when a message is selected using [+ Block] or [- Block] buttons. Press the switch when it is blinking to deselect the message and return to the latest alarm display.										
Change Display Order	Change the message display order between [Ascending Order] and [Descending Order].										
Display Change-over	Change the date and time display format between [Date Only] and [Time Only].										
Acknowledge	Acknowledge the selected unacknowledged messages.										
Acknowledge All	Acknowledge all unacknowledged messages.										
Filter Display	Change the information to display. Select the information to display from group, occurrence, cancellation, acknowledgment, and normal.										
File Select	Display a backup file (CSV) saved to a storage device.										
Count Display	Display the number of event history entries or the count value of the selected message.										
Time Display	Display the latest time of the event history or the time of the selected message. <table border="1" style="width: 100%; border-collapse: collapse;"> <tr> <td style="width: 50%;">Less than 8 digits</td> <td>Hide</td> </tr> <tr> <td>8 to 11 digits</td> <td>Hour, minutes, and seconds</td> </tr> <tr> <td>12 to 17 digits</td> <td>Hour, minutes, seconds, and milliseconds</td> </tr> <tr> <td>18 to 22 digits</td> <td>Month, day, hour, minutes, seconds, and milliseconds</td> </tr> <tr> <td>23 digits or more</td> <td>Year, month, day, hour, minutes, seconds, and milliseconds</td> </tr> </table>	Less than 8 digits	Hide	8 to 11 digits	Hour, minutes, and seconds	12 to 17 digits	Hour, minutes, seconds, and milliseconds	18 to 22 digits	Month, day, hour, minutes, seconds, and milliseconds	23 digits or more	Year, month, day, hour, minutes, seconds, and milliseconds
Less than 8 digits	Hide										
8 to 11 digits	Hour, minutes, and seconds										
12 to 17 digits	Hour, minutes, seconds, and milliseconds										
18 to 22 digits	Month, day, hour, minutes, seconds, and milliseconds										
23 digits or more	Year, month, day, hour, minutes, seconds, and milliseconds										
Status Display	Display the event history status. Occurrence/cancellation/acknowledgment/normal										
Mode (Switch)	Display real time display messages on a switch.										
Mode (Lamp)	Display real time display messages on a lamp.										
Adjust Position	Display the window for adjusting the placement position of each part. Part size can also be changed.										
Select from catalogs	Set the part design from the catalog.										
Parts Design	Set the design and color of the part selected in the [Additional Parts List] or preview pane.										
Edit Selected Parts	Set the part selected in the [Additional Parts List] or preview pane.										

## Show/Hide

Set the show and hide settings of alarm parts.

 For details, refer to “14 Item Show/Hide Function”

## Detail

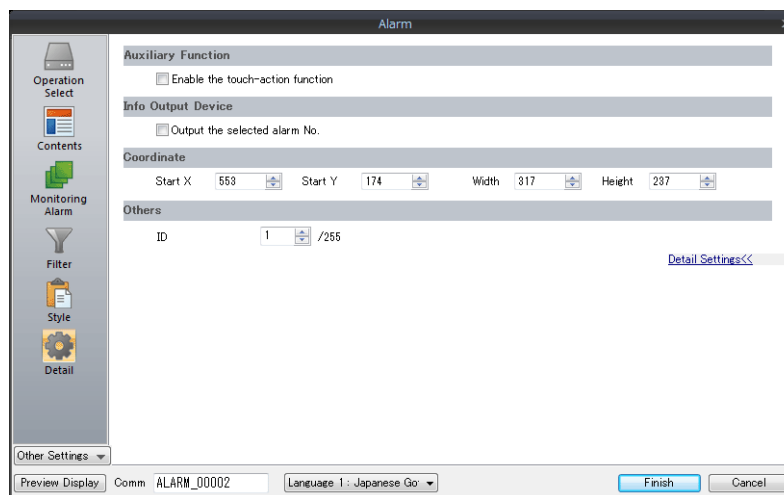

Item		Description
Auxiliary Function	Enable the touch-action function	Changeover the screen by tapping the displayed alarm message. * Enable [Touch Action] on the alarm server.
Info. Output Device	Output the selected alarm No.	Store the alarm number selected (cursor display) on MONITOUCH into the specified device memory address. Use this setting to display detailed alarm information.
Coordinate	Start X / Start Y	Set the placement position and size of the display area.
	Width/Height	
Others	ID	Set the ID of the alarm part.

# MEMO

MONITOUCH





## **9 Graph Display**

---

- 9.1 Bar Graph
- 9.2 Pie Graph
- 9.3 Closed Area Graphs
- 9.4 Panel Meter
- 9.5 Statistic Bar Graph
- 9.6 Statistic Pie Graph

## 9.1 Bar Graph

### 9.1.1 Overview

- Data in a device memory address can be expressed on a bar graph.

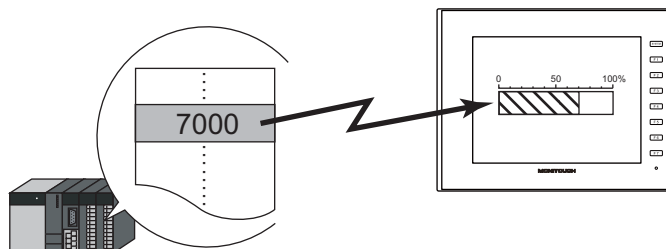

 For setting examples, refer to [“Displaying Current Values \(Standard Display\)”](#) page 9-2.

- When data in a device memory address exceeds or falls short of the range specified, the graph color can be changed. This helps the operator to recognize the situation easily and correctly.

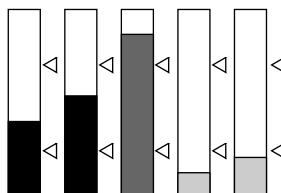

 For setting examples, refer to [“Displaying Current Values \(Standard Display\)”](#) page 9-2.

- As shown below, it is possible to display a bar graph in several colors.

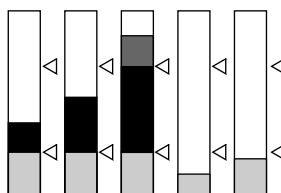

 For setting examples, refer to [“Displaying Current Values \(Standard Display\)”](#) page 9-2.

- A reference point can be set and then data from the reference point to the specified data in a device memory address can be expressed on a graph (deviation display).

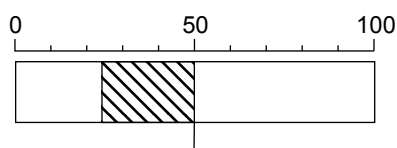

 For setting examples, refer to [“Displaying Deviation from a Reference Value to the Current Value \(Deviation Display\)”](#) page 9-4.

## 9.1.2 Setting Examples

### Displaying Current Values (Standard Display)

The current value of a device memory address within the range of the minimum and maximum values can be displayed (standard display).

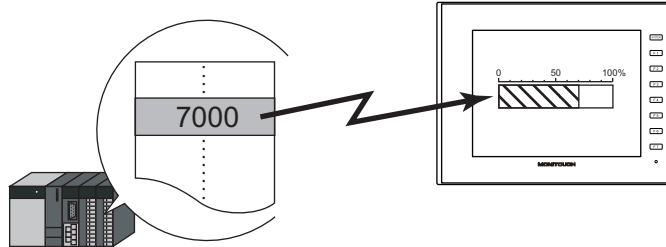

1. Click [Parts] → [Graph] → [Bar Graph] and place a bar graph on the screen.

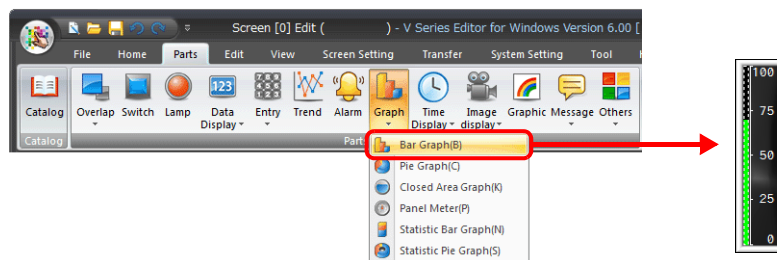

2. Double-click on the bar-graph to display the settings window.  
 Configure the [Contents] settings as shown below.
  - Set the device memory address to display on the graph with [Current Value] → [Device].
  - Select [Standard] for [Type].
  - Specify the graph display area using [Range].

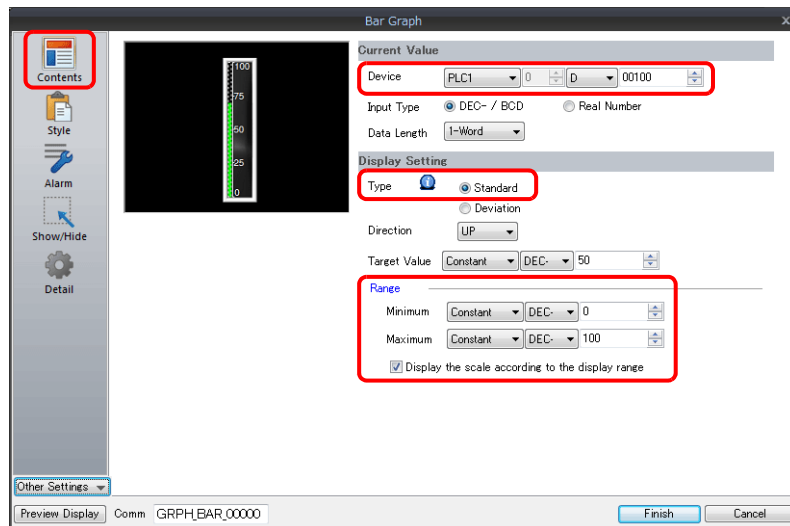

- Configure the following settings for [Style] and then click [Finish].  
To change the graph color depending on the value, proceed to step 4.

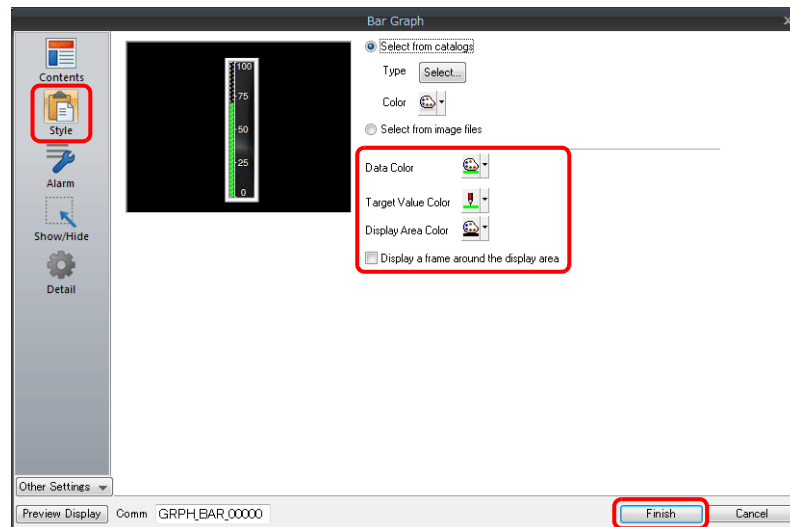

- Configure the [Alarm] settings to change the graph color depending on the value.  
In this case, color settings set for [Style] are disabled.

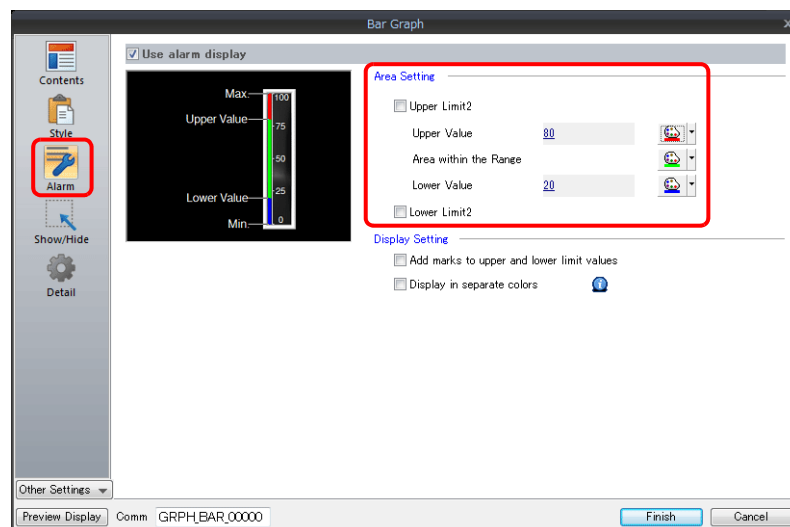

- Set the following to display the graph using the different colors for different value ranges.

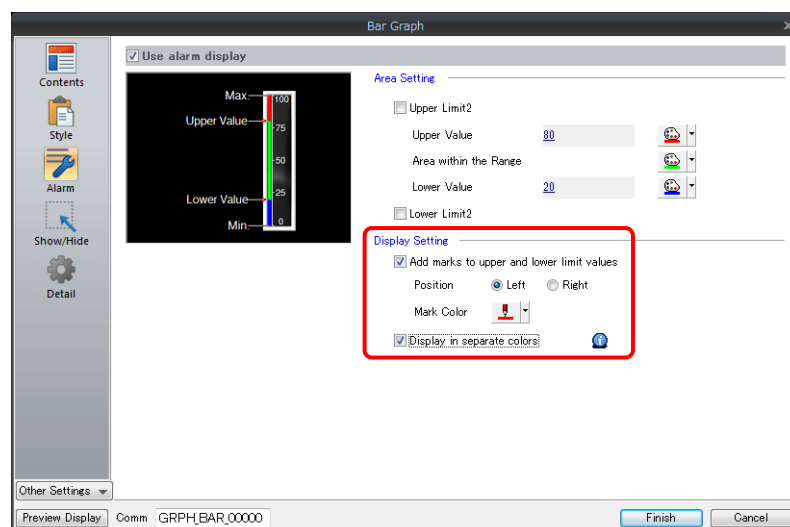

This completes the necessary settings.

## Displaying Deviation from a Reference Value to the Current Value (Deviation Display)

A reference point can be set and then data from the reference point to the specified device memory address can be expressed on a graph.

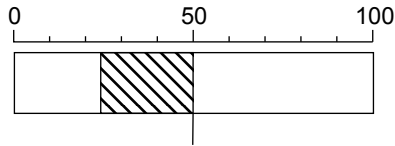

1. Click [Parts] → [Graph] → [Bar Graph] and place a bar graph on the screen.

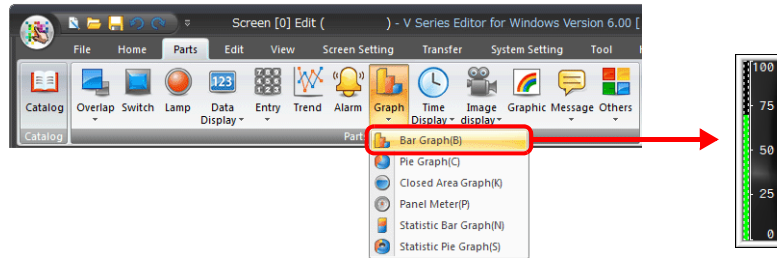

2. Double-click on the bar-graph to display the settings window. Configure the [Contents] settings as shown below.
  - Set the device memory address to display on the graph with [Current Value] → [Device].
  - Select [Deviation] for [Type].
  - Specify the value or device memory address to be used as the reference for [Standard].
  - Specify the graph display area.

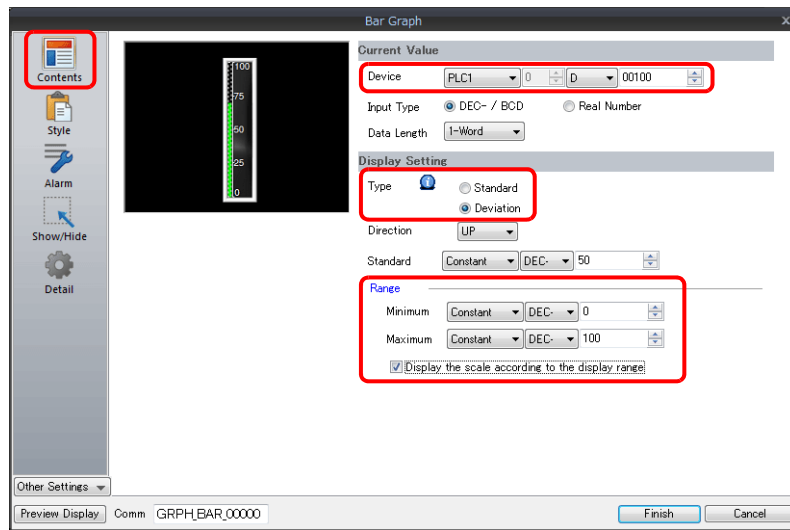

- Configure the following settings for [Style] and then click [Finish].  
To change the graph color depending on the value, proceed to step 4.

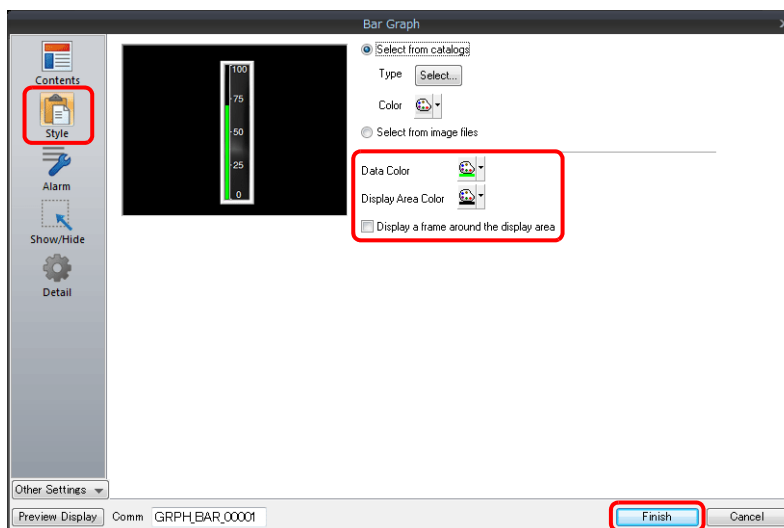

- Configure the [Alarm] settings to change the graph color depending on the value.  
In this case, color settings set for [Style] are disabled.

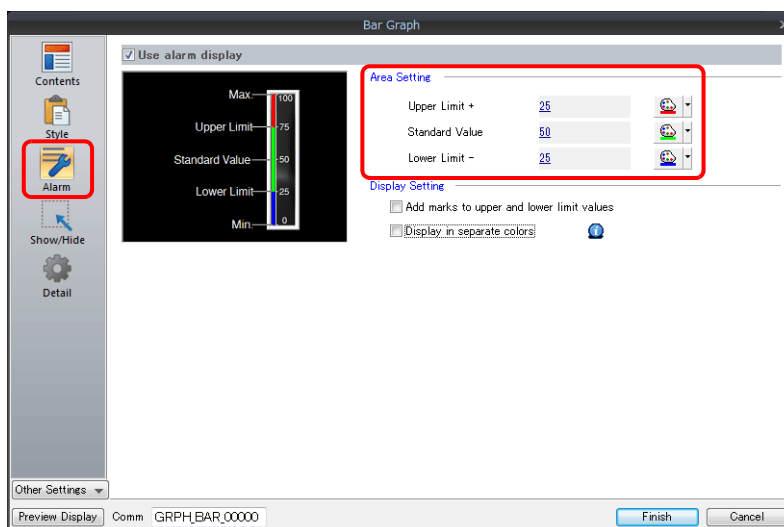

- Set the following to display the graph using the different colors for different value ranges.

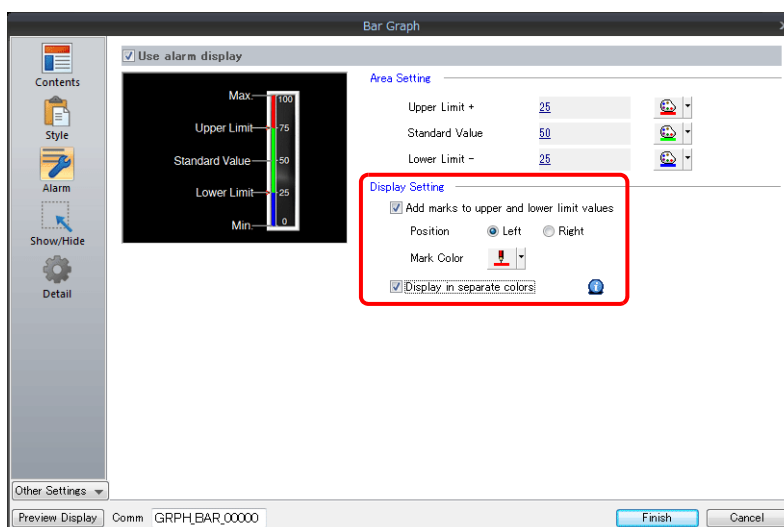

This completes the necessary settings.

### 9.1.3 Detailed Settings

#### Displayed Information

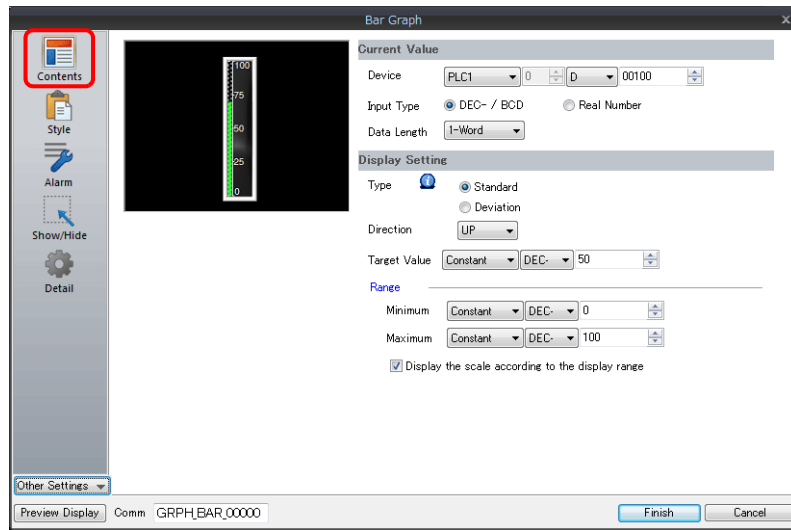

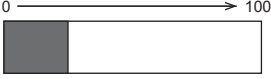
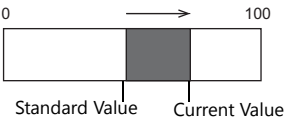
Item		Description
Current Value	Device	Specify the device memory address to monitor as a graph.
	Input Type (DEC- / BCD, Real Number)	Select the data format of device memory values. The selection here also applies to the values of [Target Value], [Standard Value], [Range], and [Alarm].  * When [DEC-/BCD] is selected, the setting at [Code: DEC/BCD] under [Communication Setting] in the [PLC Properties] window accessible via [System Setting] → [Hardware Setting] takes effect.
	Data Length (1-Word, 2-Word)	Select data length of the device memory.
Display Setting	Type (Standard, Deviation)	Standard Display the device memory value between the minimum and maximum values on a graph.    Deviation Set a reference value and display deviation from the reference value to the current value.  
	Direction (UP, DW, LFT, RGT)	Set the direction to draw graph lines. Vertical bar graph: UP / DW Horizontal bar graph: LFT / RGT
	Target Value, Standard	Target Value Set this when [Standard] is selected for [Type]. Display a line at the position of the target value on the graph. * If a value less than the minimum value of the range is set, a line is not displayed.  Standard Set this when [Deviation] is selected for [Type]. Specify the reference value of the graph.  * If [Alarm] is configured, the [Standard] or [Target Value] setting is disabled.
	Range (Minimum/Maximum)	Specify the minimum and maximum values for the display range of the graph. If the display range is variable, select a device memory. If the display range is fixed, specify a constant.
	Display the scale according to the display range	This is only available for parts that correspond to a numerical display. An optimal scale is displayed according to the minimum and maximum of the value in the range.  * This setting is only available when the minimum and maximum values are specified with constants.

## Style

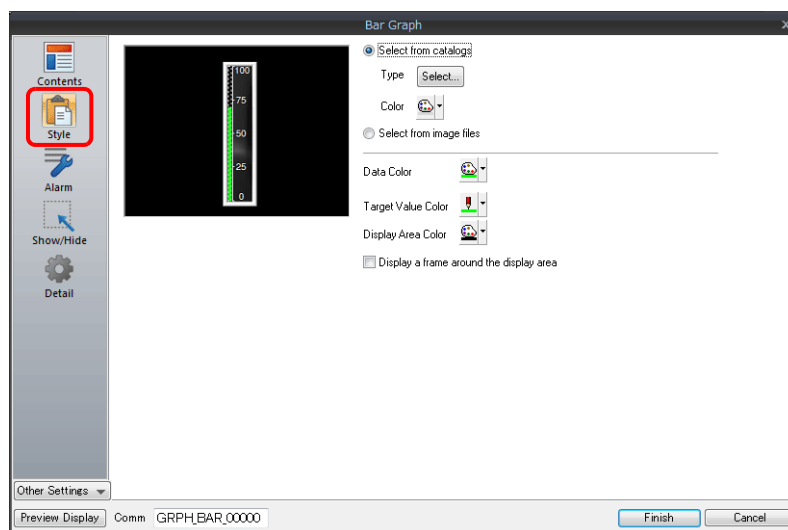

Item	Description
Select from catalogs	Type Set the part design. Color Set the part color.
Select from image files	Load an image file.
Data Color	When [Standard] is selected for [Type]: Set the graph color from the minimum value to the device memory value. When [Deviation] is selected for [Type]: Set the graph color from the reference value to the device memory value. * If [Alarm] is configured, this is disabled.
Target Value Color	When [Standard] is selected for [Type]: Set the color of the target value line displayed on the graph. * If [Alarm] is configured, this is disabled.
Display Area Color	Set the color inside the graph area.
Display a frame around the display area	Display a frame around the graph area. When this checkbox is selected, the frame color can be set.



# Alarm

- Type: Standard

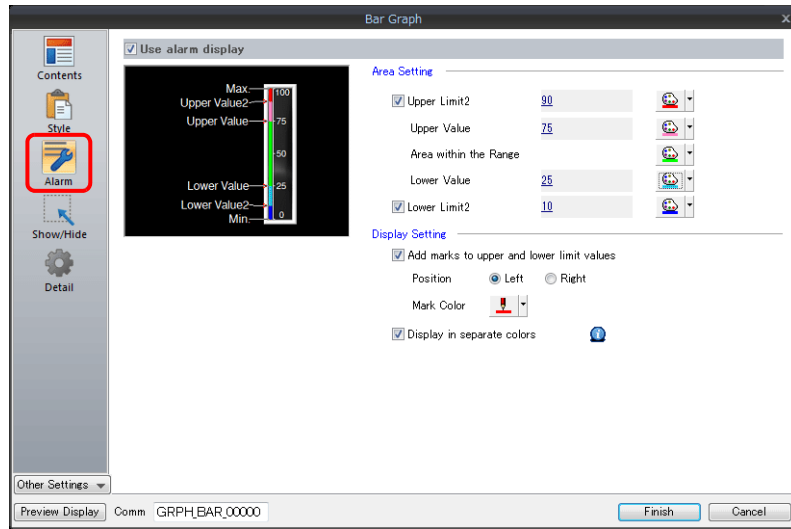

- Type: Deviation

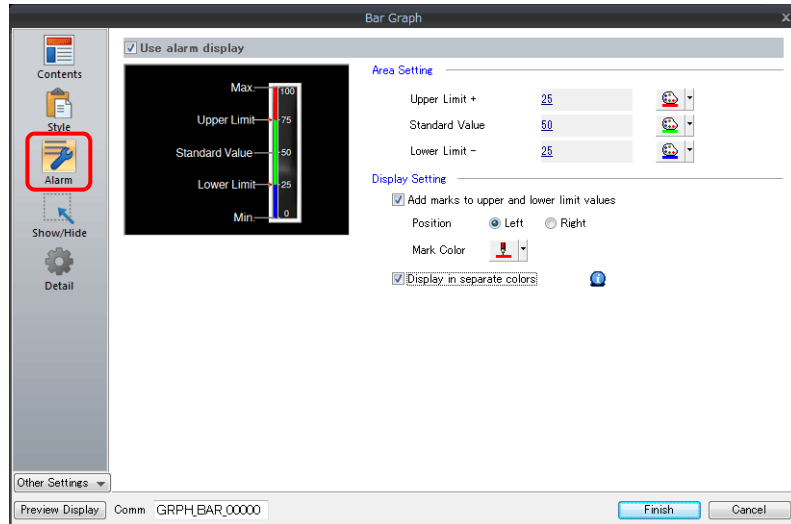

Item		Description
Use alarm display		Change the colors of the graph according to the device memory value.
Area Setting	When [Standard] is selected for [Type]: Upper Limit2/Upper Value/Area within the Range/Lower Value/Lower Limit2	Set the ranges for alarm display and each corresponding color.
	When [Deviation] is selected for [Type]: Upper Limit+/Standard Value/Lower Limit-	Set the ranges for alarm display and each corresponding color.
Display Setting	Add marks to upper and lower limit values	Display $\Delta$ marks at the alarm range positions of the graph.
	Position	Specify the position of the $\Delta$ marks. Vertical bar graph: Left/Right Horizontal bar graph: Top/Bottom
	Mark Color	Specify the color of the $\Delta$ marks.
	Display in separate colors	Display each alarm color separately on a single graph.

## Examples of graphs with alarm settings

### When [Standard] is selected for [Type]

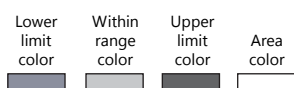

[Direction] set to RGT

• Single color use

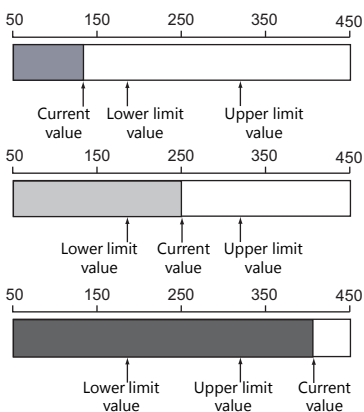

• Separate color use

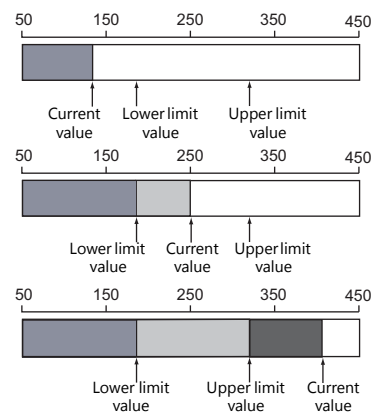

• With marks

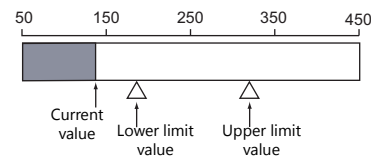

### When [Deviation] is selected for [Type]

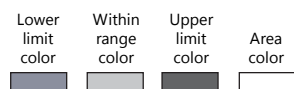

[Direction] set to RGT    A: Range value

• Single color use

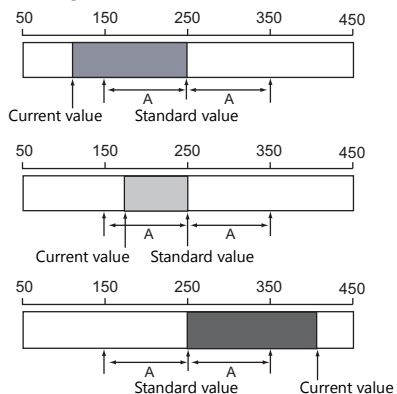

• Separate color use

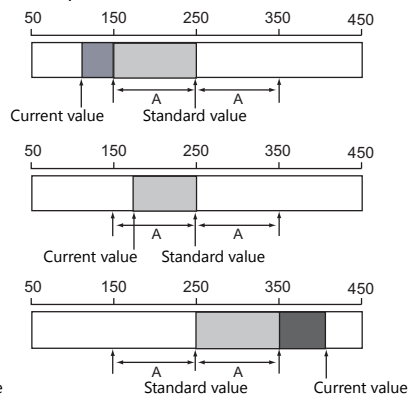

• With marks

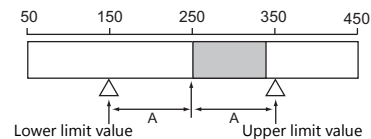

## Detail

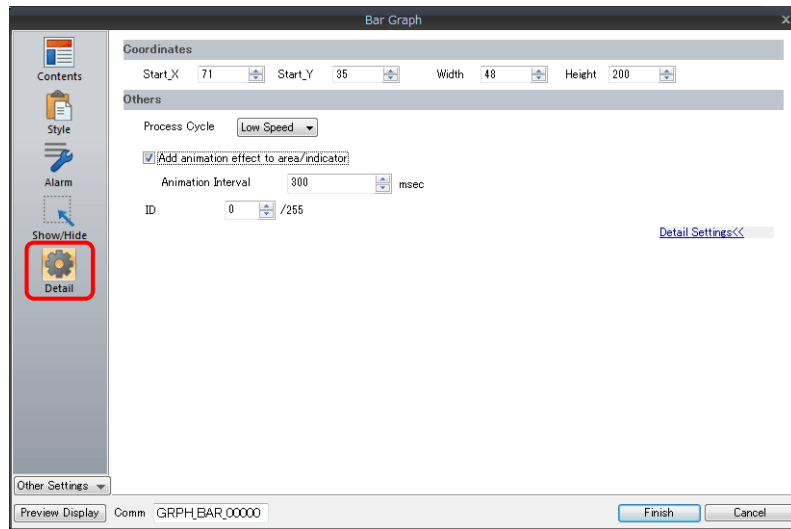

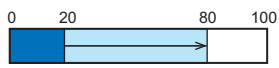
Item		Description	
Coordinates	Start X/Start Y	Specify the placement coordinates. (Coordinates at top left of part)	
	Width/Height	Specify the width and height of the part.	
Others	Process Cycle	Specify the process cycle of the part.	
	Add animation effect to area/indicator	Draw changes in the graph display over the time specified for [Animation Interval].	Example: Animation interval: 200 msec Current value changes from 20 to 80 
	Animation Interval	Set the drawing speed of changes in the graph display.	
	ID	Set the ID.	

## 9.2 Pie Graph

### 9.2.1 Overview

- Data in the specified device memory address can be expressed clockwise on a pie graph.

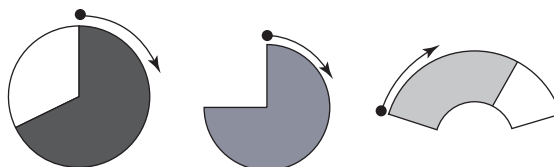

 For setting examples, refer to ["Displaying Current Values \(Standard Display\)"](#) page 9-12.

- When data in a device memory exceeds or falls short of the range specified, the graph color can be changed. This helps the operator to recognize the situation easily and correctly.



 For setting examples, refer to ["Displaying Current Values \(Standard Display\)"](#) page 9-12.

- As shown below, it is possible to display a bar graph in several colors.

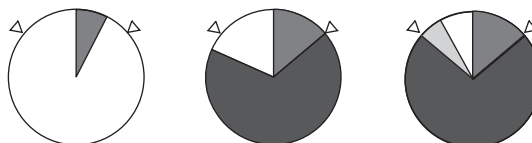

 For setting examples, refer to ["Displaying Current Values \(Standard Display\)"](#) page 9-12.

- A reference point can be set and then data from the reference point to the specified data in a device memory can be expressed on a graph (deviation display).

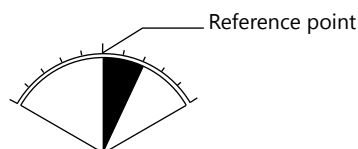

 For setting examples, refer to ["Displaying Deviation from a Reference Value to the Current Value \(Deviation Display\)"](#) page 9-14.

## 9.2.2 Setting Examples

### Displaying Current Values (Standard Display)

The current value of a device memory within the range of the minimum and maximum values can be displayed (standard display).

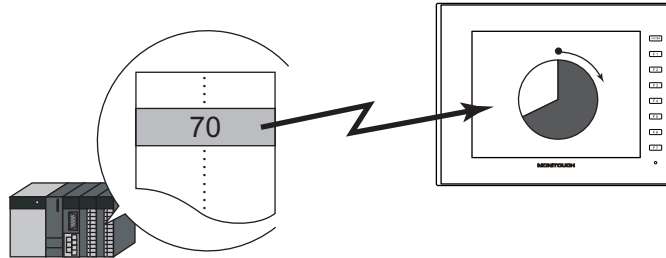

1. Click [Parts] → [Graph] → [Pie Graph] and place a pie graph on the screen.

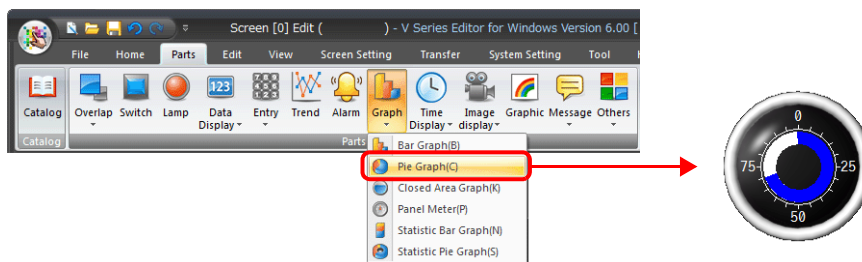

2. Double-click on the pie graph to display the settings window. Configure the [Contents] settings as shown below.
  - Set the device memory address to display on the graph with [Current Value] → [Device].
  - Select [Standard] for [Type].
  - Specify the graph display area using [Range].

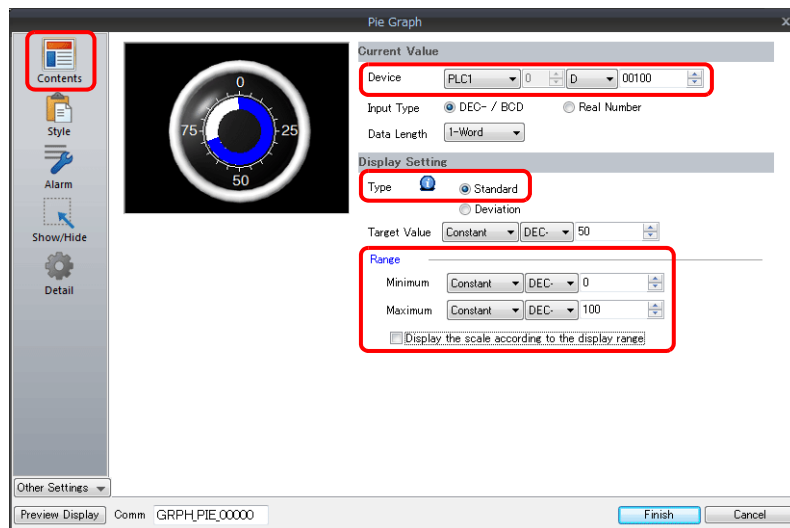

- Configure the following settings for [Style] and then click [Finish].  
To change the graph color depending on the value, proceed to step 4.

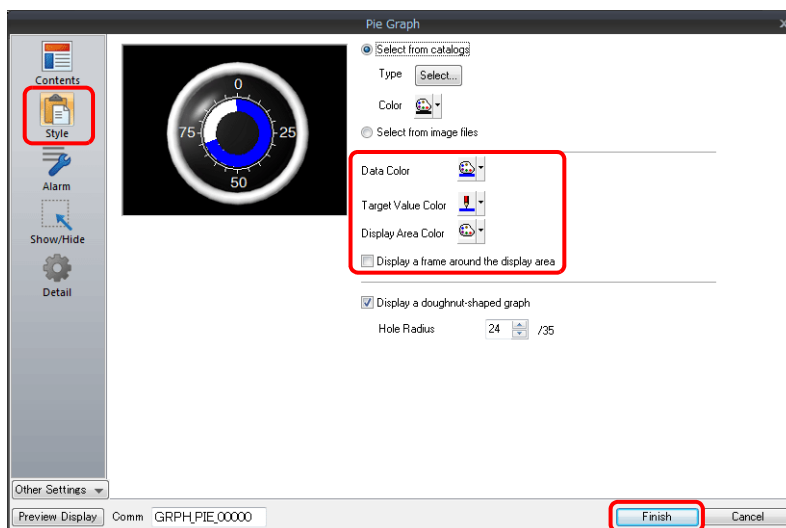

- Configure the [Alarm] settings to change the graph color depending on the value.  
In this case, color settings set for [Style] are disabled.

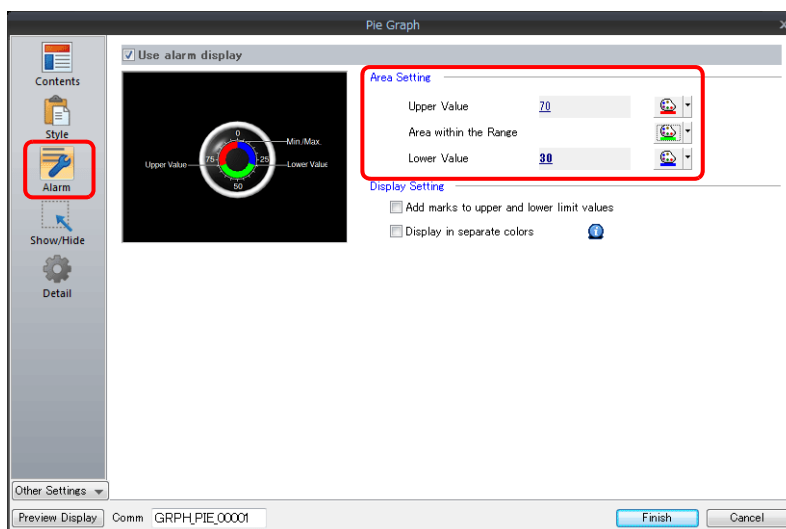

- Set the following to display the graph using the different colors for different value ranges.

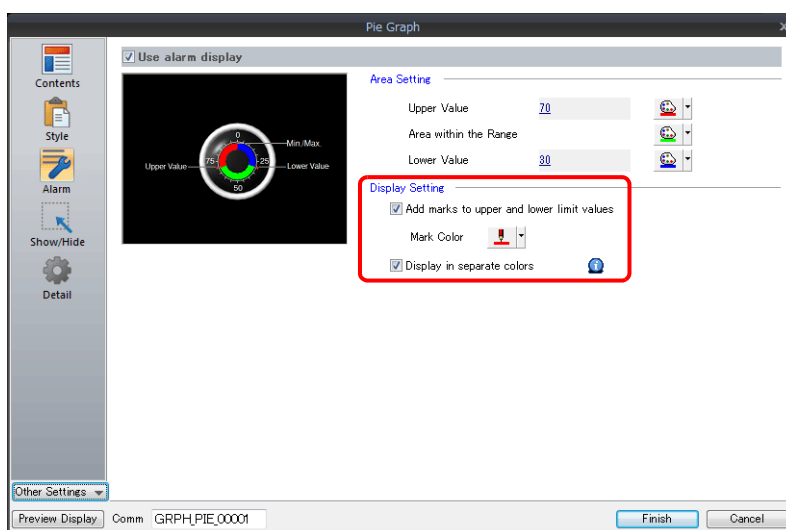

This completes the necessary settings.

## Displaying Deviation from a Reference Value to the Current Value (Deviation Display)

A reference point can be set and then data from the reference point to the specified device memory address can be expressed on a graph.

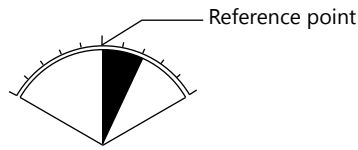

1. Click [Parts] → [Graph] → [Pie Graph] and place a pie graph on the screen.

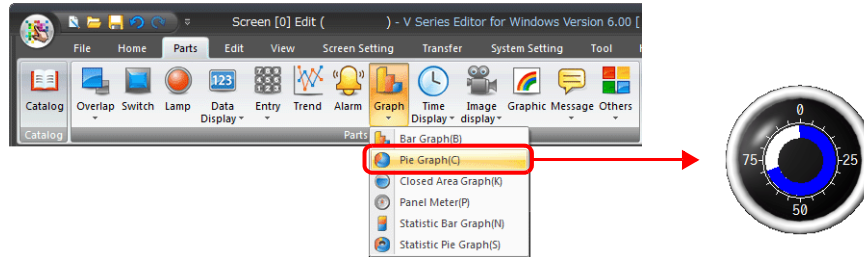

2. Double-click on the pie graph to display the settings window.  
Configure the [Contents] settings as shown below.
  - Set the device memory address to display on the graph with [Current Value] → [Device].
  - Select [Deviation] for [Type].
  - Specify the value or device memory address to be used as the reference for [Standard].
  - Specify the graph display area.

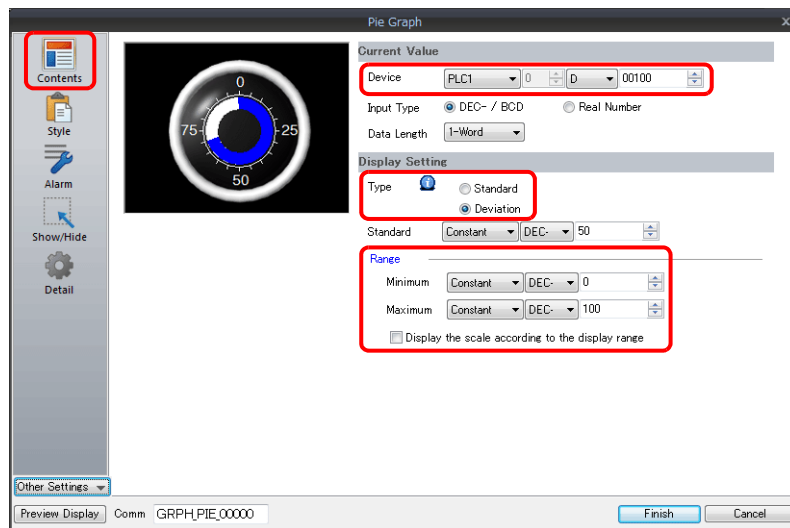

- Configure the following settings for [Style] and then click [Finish].  
To change the graph color depending on the value, proceed to step 4.

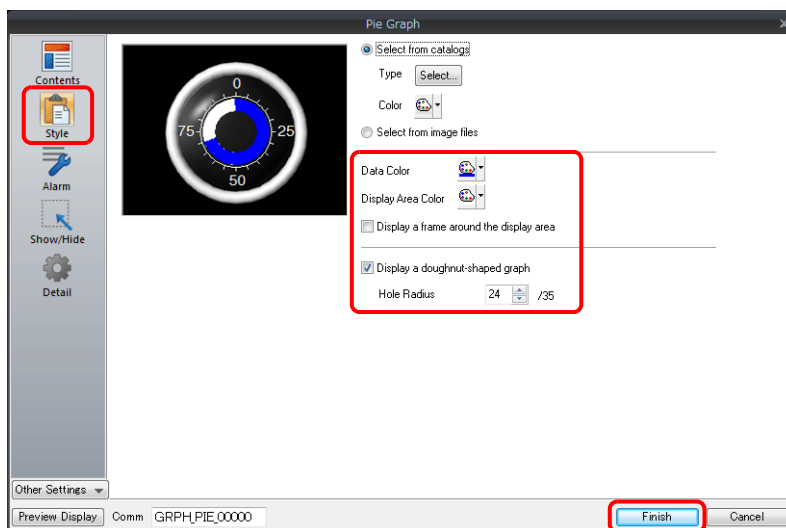

- Configure the [Alarm] settings to change the graph color depending on the value.  
In this case, color settings set for [Style] are disabled.

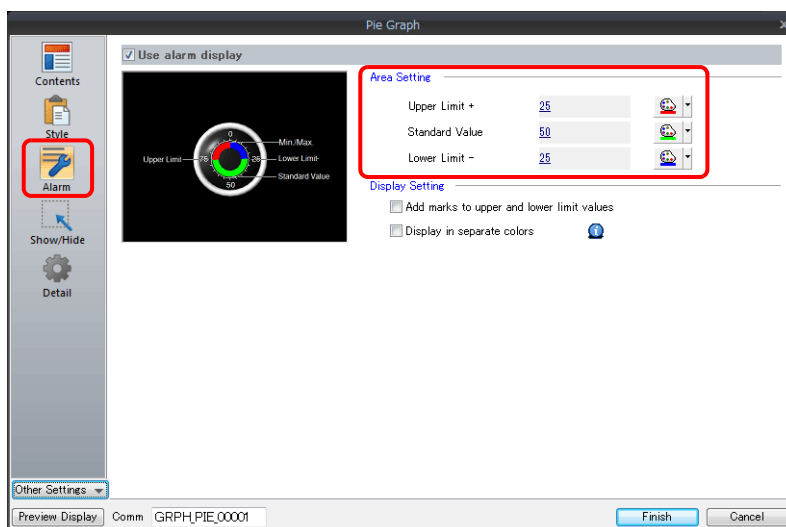

- Set the following to display the graph using different colors for different value ranges.

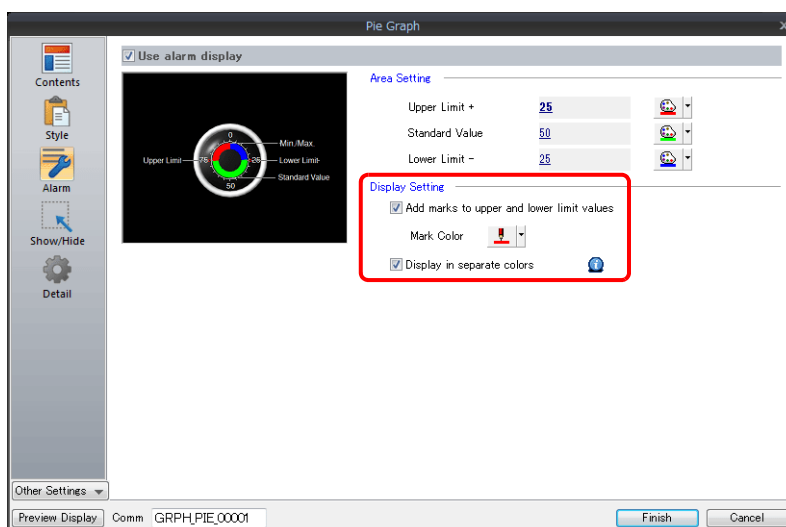

This completes the necessary settings.



## 9.2.3 Detailed Settings

### Displayed Information

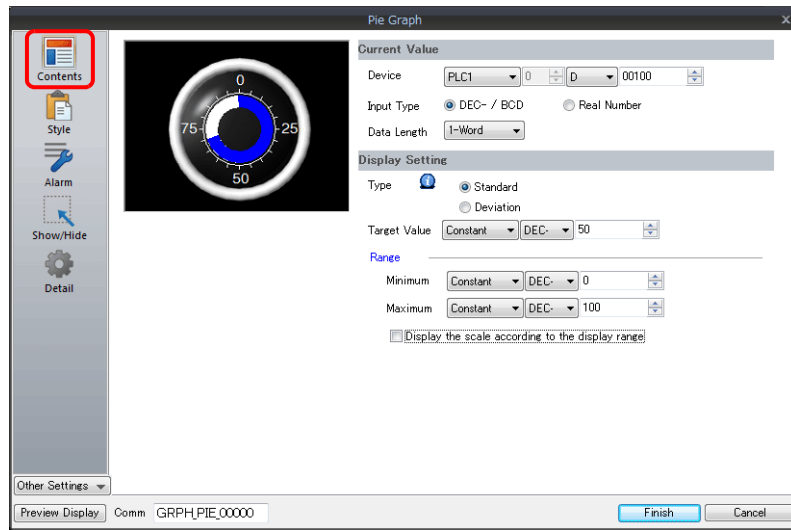

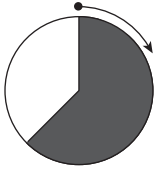
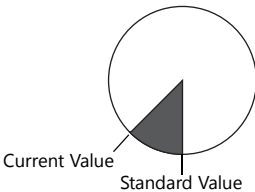
Item		Description
Current Value	Device	Specify the device memory address to monitor as a graph.
	Input Type (DEC- / BCD, Real Number)	Select the data format of device memory values. The selection here also applies to the values of [Target Value], [Standard Value], [Range], and [Alarm].  * When [DEC-/BCD] is selected, the setting at [Code: DEC/BCD] under [Communication Setting] in the [PLC Properties] window accessible via [System Setting] → [Hardware Setting] takes effect.
	Data Length (1-Word, 2-Word)	Select data length of the device memory.
Display Setting	Type (Standard, Deviation)	Standard Display the device memory value between the minimum and maximum values on a graph.    Deviation Set a reference value and display deviation from the reference value to the current value.  
	Target Value, Standard	Target Value Set this when [Standard] is selected for [Type]. Display a line at the position of the target value on the graph. * If a value less than the minimum value of the range is set, a line is not displayed.  Standard Set this when [Deviation] is selected for [Type]. Specify the reference value of the graph.  * If [Alarm] is configured, the [Standard] or [Target Value] setting is disabled.
	Range (Minimum/Maximum)	Specify the minimum and maximum values for the display range of the graph. If the display range is variable, select a device memory. If the display range is fixed, specify a constant.
	Display the scale according to the display range	This is only available for parts that correspond to a numerical display. An optimal scale is displayed according to the minimum and maximum of the value in the range.  * This setting is only available when the minimum and maximum values are specified with constants.

## Style

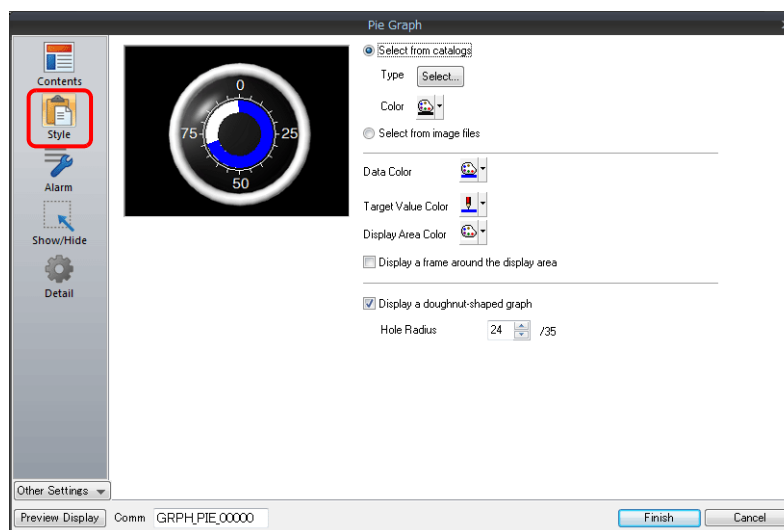

Item	Description
Select from catalogs	Type Set the part design. Color Set the part color.
Select from image files	Load an image file.
Data Color	When [Standard] is selected for [Type]: Set the graph color from the minimum value to the device memory value. When [Deviation] is selected for [Type]: Set the graph color from the reference value to the device memory value. * If [Alarm] is configured, this is disabled.
Target Value Color	When [Standard] is selected for [Type]: Set the color of the target value line displayed on the graph. * If [Alarm] is configured, this is disabled.
Display Area Color	Set the color inside the graph area.
Display a frame around the display area	Display a frame around the graph area. When this checkbox is selected, the frame color can be set.
Display a doughnut-shaped graph	Display a doughnut-shaped pie graph. Select this checkbox to set the hole radius.

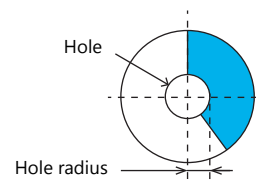

## Alarm

- Type: Standard

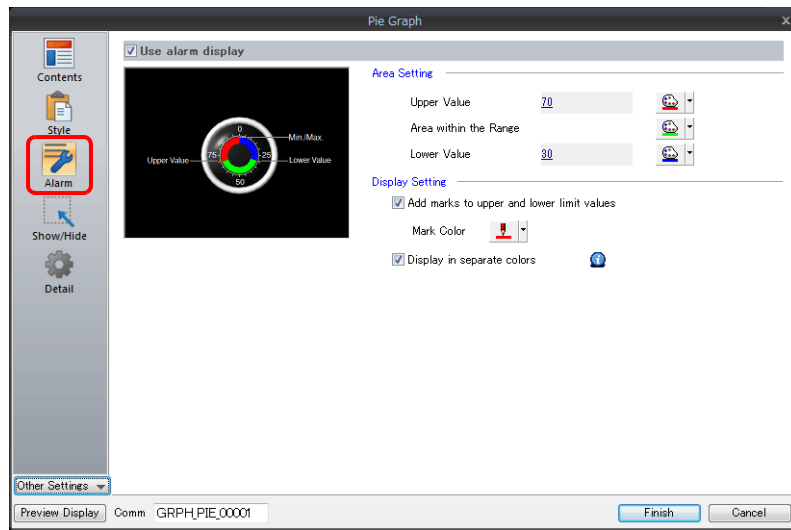

- Type: Deviation

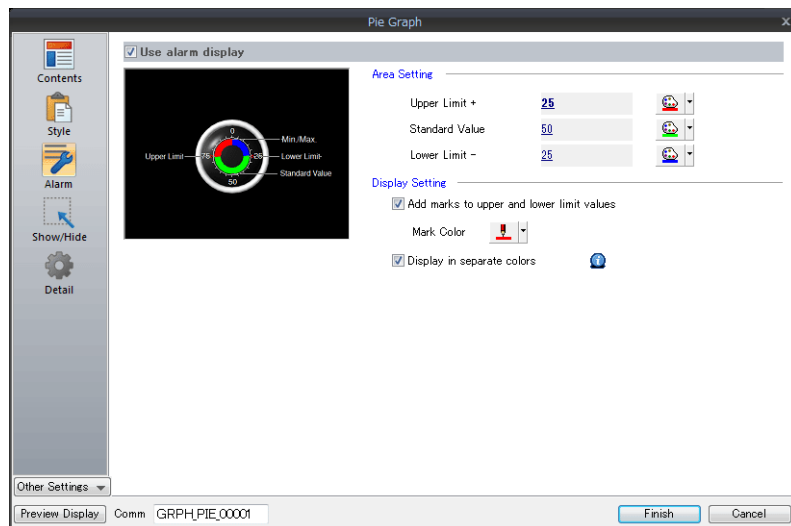

Item		Description
Use alarm display		Change the colors of the graph according to the device memory value. The color settings are implemented in the area settings.
Area Setting	When [Standard] is selected for [Type]: Upper Value/Area within the Range/Lower Value	Set the range for alarm display and each corresponding color.
	When [Deviation] is selected for [Type]: Upper Limit+ /Standard Value/Lower Limit-	Set the reference value as well as the range for alarm display and each corresponding color.
Display Setting	Add marks to upper and lower limit values	Display $\Delta$ marks at the alarm range positions of the graph.
	Mark Color	Specify the color of the $\Delta$ marks.
	Display in separate colors	Display each alarm color separately on a single graph.

## Examples of graphs with alarm settings

### When [Standard] is selected for [Type]

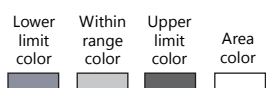

- Single color use

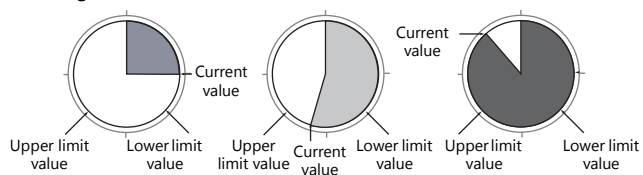

- Separate color use

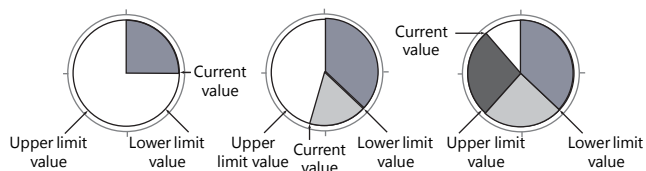

- With marks

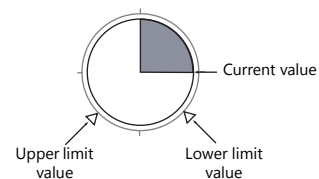

### When [Deviation] is selected for [Type]

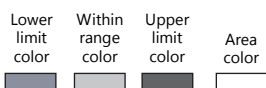

A: Range value

- Single color use

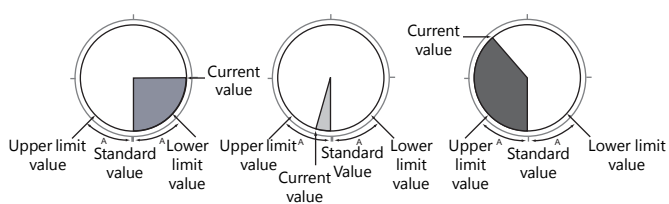

- Separate color use

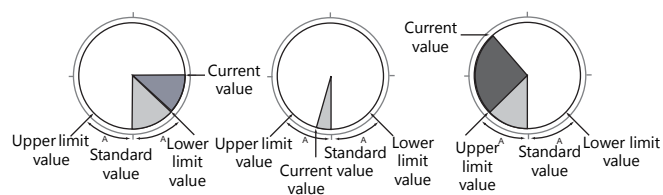

- With marks

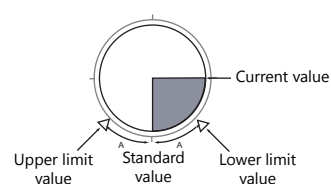

## Detail

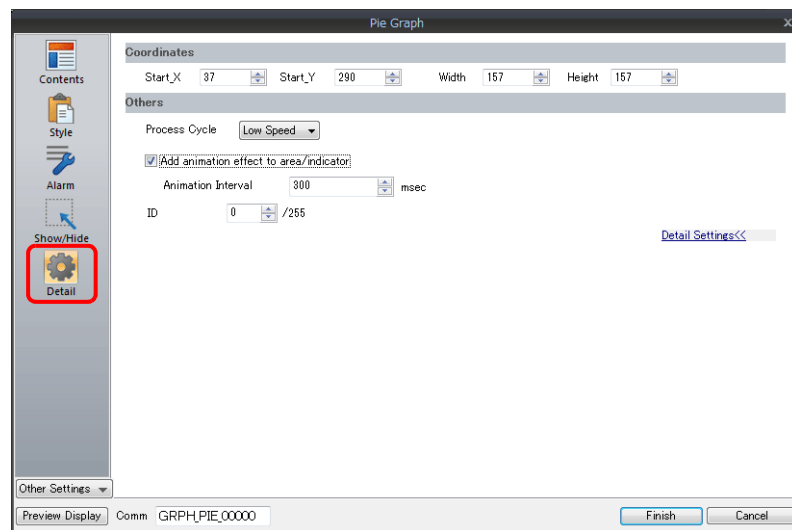

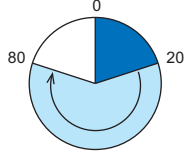

	Item	Description	
Coordinates	Start X/Start Y	Specify the placement coordinates. (Coordinates at top left of part)	
	Width/Height	Specify the width and height of the part.	
Others	Process Cycle	Specify the process cycle of the part.	
	Add animation effect to area/indicator	Draw changes in the graph display over the time specified for [Animation Interval].	Example: Animation interval: 200 msec Current value changes from 20 to 80  Increase on graph occurs over 200 msec
	Animation Interval	Set the drawing speed of changes in the graph display.	
	ID	Set the ID.	

## 9.3 Closed Area Graphs

### 9.3.1 Overview

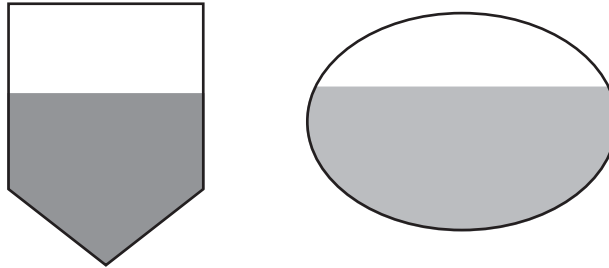
- Changes to data in a closed area, such as a tank, can be expressed on a closed area graph.



 For setting examples, refer to ["Displaying Current Values" page 9-22](#).

- When data in a device memory exceeds or falls short of the range specified, the graph color can be changed.

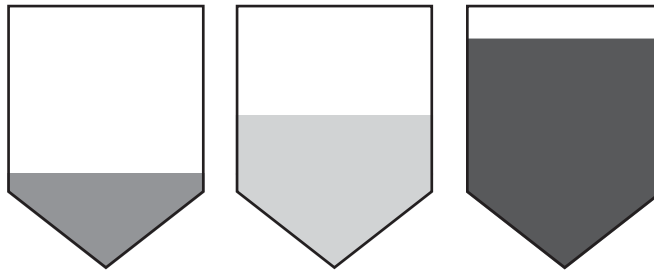

 For setting examples, refer to ["Displaying Current Values" page 9-22](#).

- As shown below, it is possible to display a bar graph in several colors.

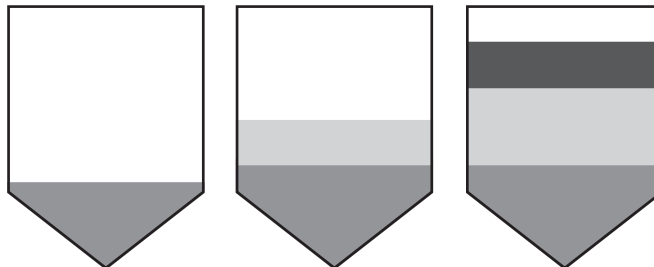

 For setting examples, refer to ["Displaying Current Values" page 9-22](#).

## 9.3.2 Setting Examples

### Displaying Current Values

The current value of a device memory within the range of the minimum and maximum values can be displayed.

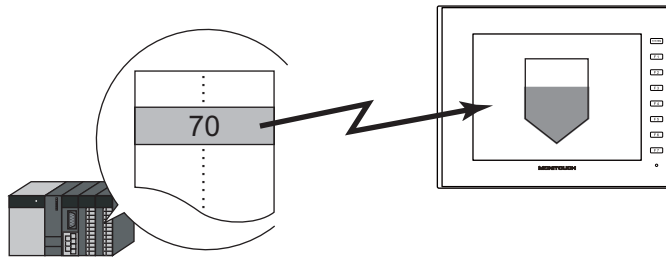

1. Click [Parts] → [Graph] → [Closed Area Graph] and place a closed area graph on the screen.

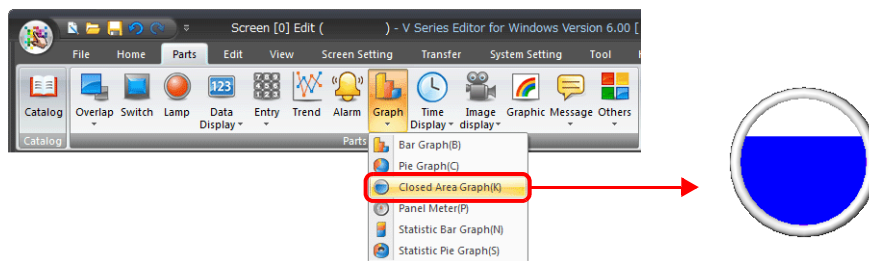

2. Double-click on the closed area graph to display the settings window. Configure the [Contents] settings as shown below.
  - Set the device memory address to display on the graph with [Current Value] → [Device].
  - Specify the graph display area using [Display Range].

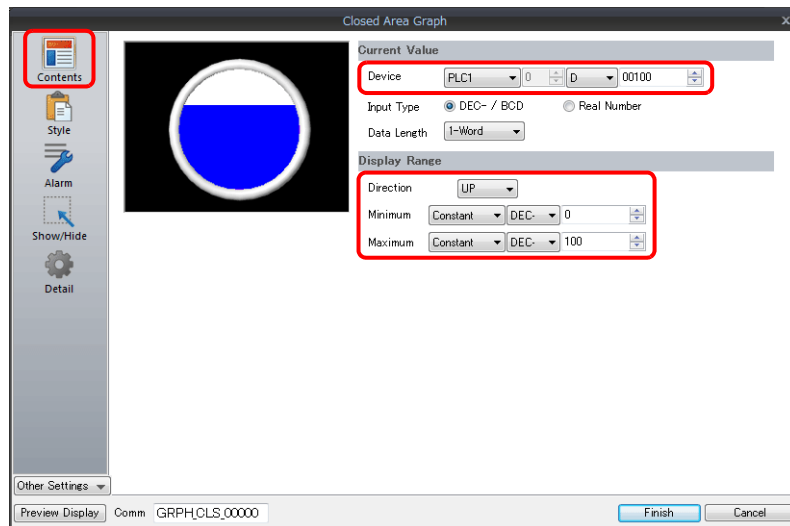

- Configure the following settings for [Style] and then click [Finish].  
To change the graph color depending on the value, proceed to step 4.

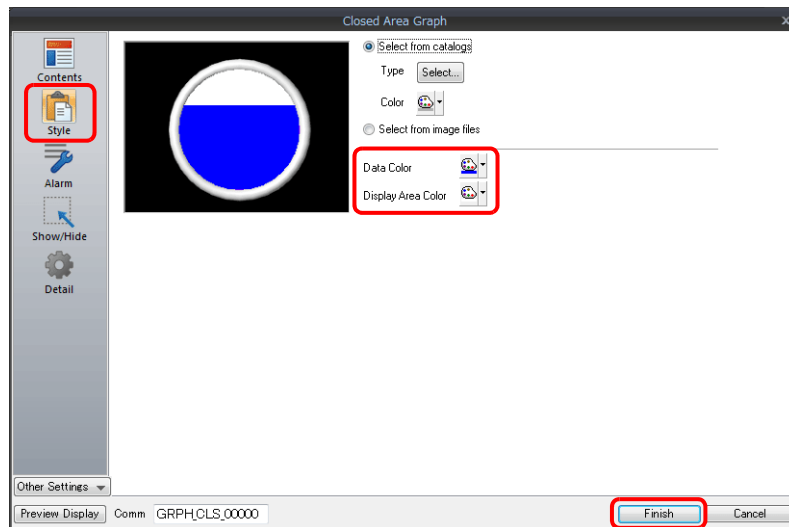

- Configure the [Alarm] settings to change the graph color depending on the value.  
In this case, color settings set for [Style] are disabled.

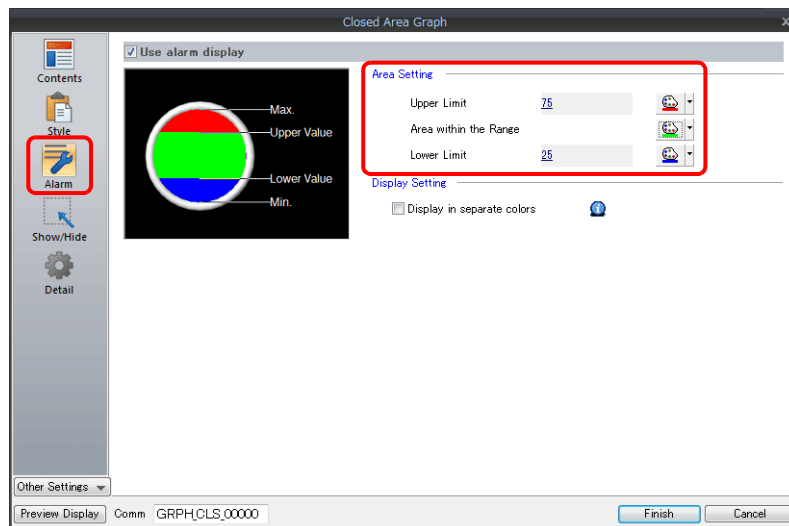

- Set the following to display the graph using the different colors for different value ranges.

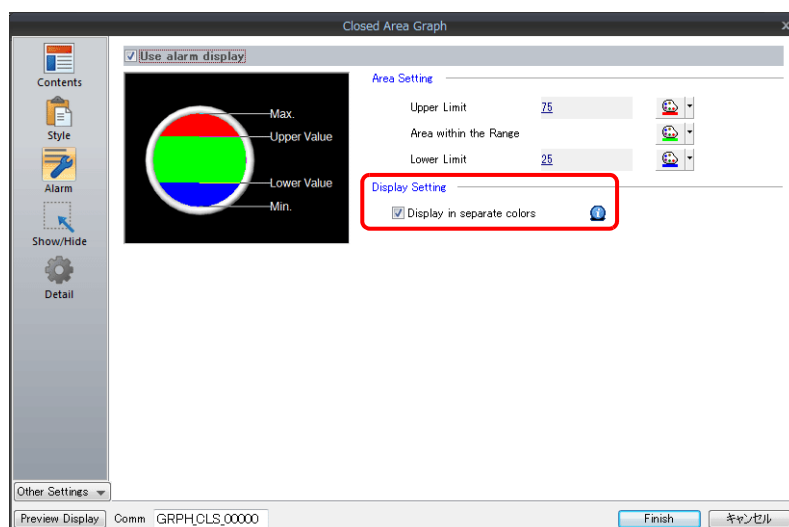

This completes the necessary settings.



### 9.3.3 Detailed Settings

#### Displayed Information

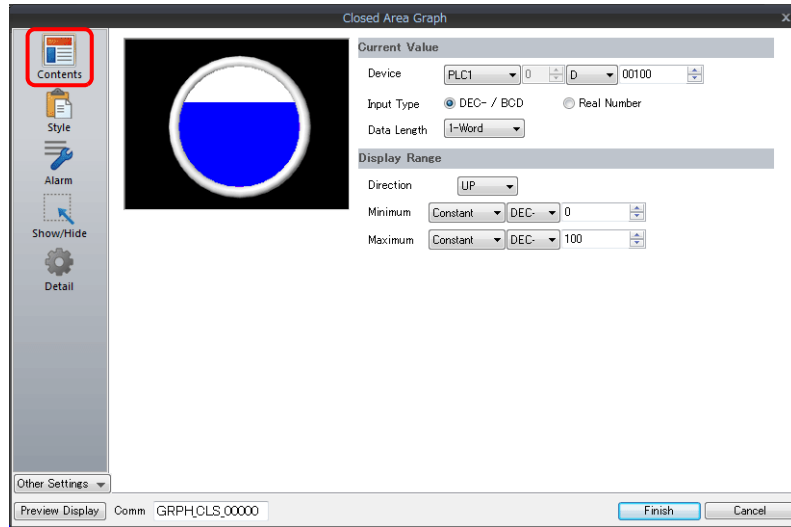

Item		Description
Current Value	Device	Specify the device memory address to monitor as a graph.
	Input Type (DEC- / BCD, Real Number)	Select the data format of device memory values. The selection here also applies to the values of [Display Range] and [Alarm]. * When [DEC-/BCD] is selected, the setting at [Code: DEC/BCD] under [Communication Setting] in the [PLC Properties] window accessible via [System Setting] → [Hardware Setting] takes effect.
	Data Length (1-Word, 2-Word)	Select data length of the device memory.
Display Range	Direction (UP, DW, LFT, RGT)	Set the direction to draw graph lines.
	Minimum/Maximum	Specify the minimum and maximum values for the range of the graph. If the display range is variable, select a device memory. If the display range is fixed, specify a constant.

#### Style

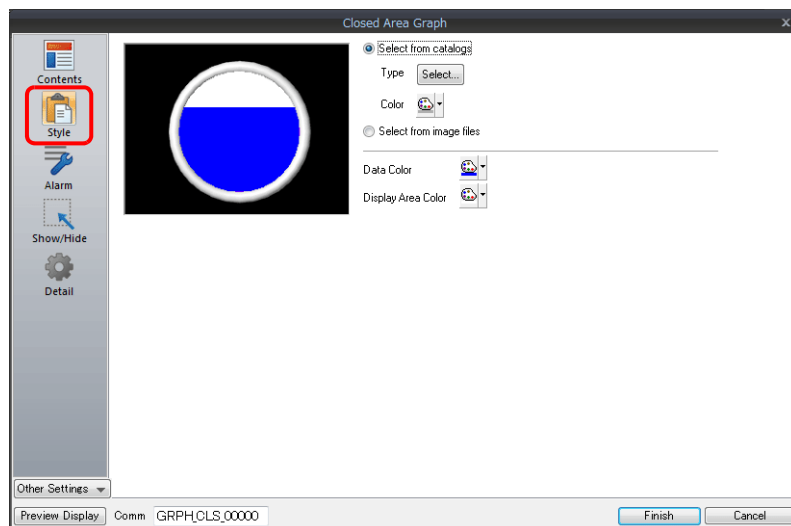

Item	Description
Select from catalogs	Type Set the part design. Color Set the part color.
Select from image files	Load a PNG file.
Data Color	Set the graph color from the minimum value to the device memory value. * If [Alarm] is configured, this is disabled.
Display Area Color	Set the color inside the graph area.

# Alarm

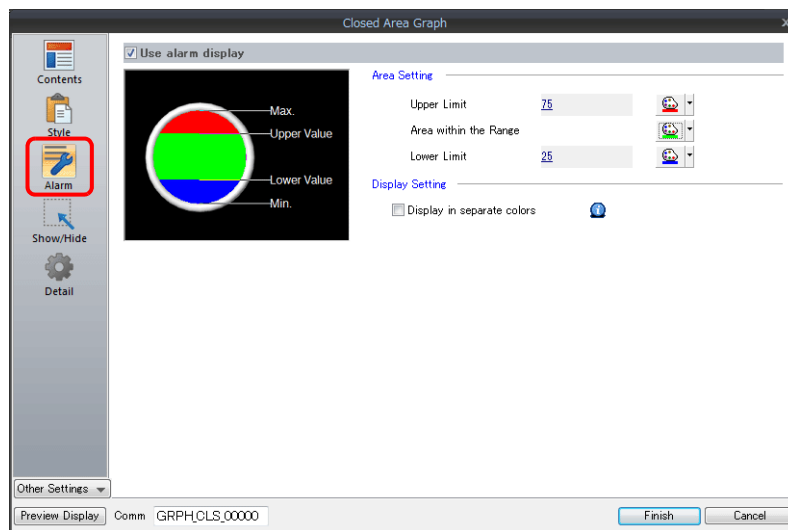

Item		Description
Use alarm display		Change the colors of the graph according to the device memory value. The color settings are implemented in the area settings.
Area Setting	Upper Limit/Area within the Range/Lower Limit	Set the range for alarm display and each corresponding color.
Display Setting	Display in separate colors	Display each alarm color separately on a single graph.

## Examples of graphs with alarm settings

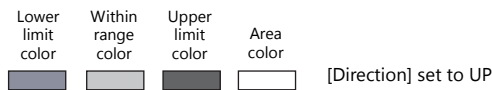

- Single color use

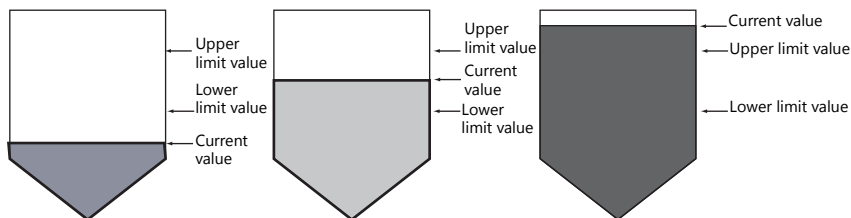

- Separate color use

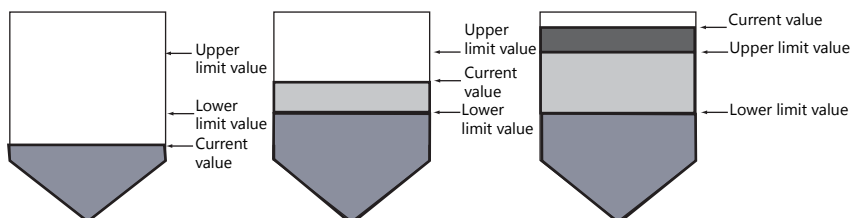

## Detail

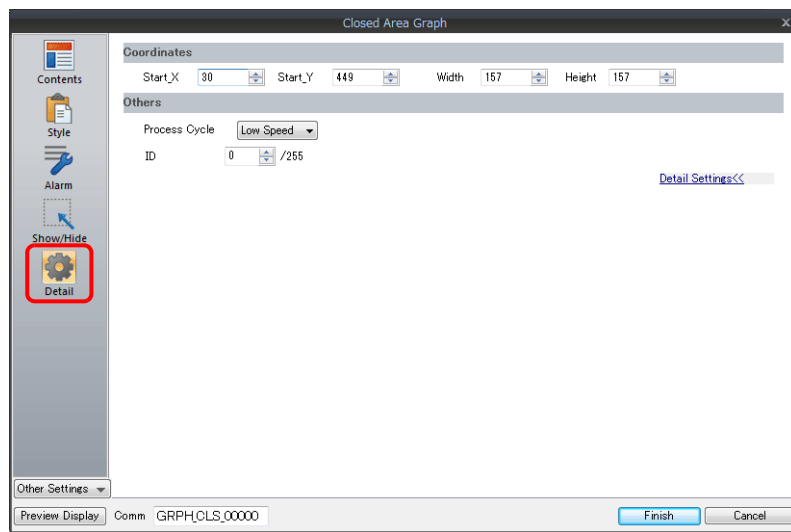

Item		Description
Coordinates	Start X/Start Y	Specify the placement coordinates. (Coordinates at top left of part)
	Width/Height	Specify the width and height of the part.
Others	Process Cycle	Specify the process cycle of the part.
	ID	Set the ID.

## 9.4 Panel Meter

### 9.4.1 Overview

- Data in a device memory can be expressed in the form of an analog meter. The indicator can be selected to move in either the clockwise or counterclockwise direction.

 For setting examples, refer to ["Displaying Current Values" page 9-28.](#)



- Alarm display
  - Location used for alarms: indicator

When data in the device memory exceeds or falls short of the range specified, the indicator color changes to show the status.

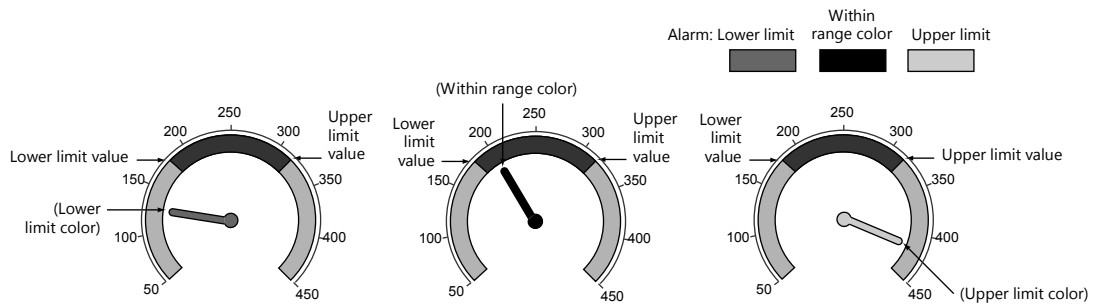



 For setting examples, refer to ["Displaying Current Values" page 9-28.](#)

- Location used for alarms: Area
- When divisions are made in the alarm range, these divisions can be colored separately. Division into a maximum of 16 sections is allowed.

Note that the color of the indicator does not change according to the alarm condition.

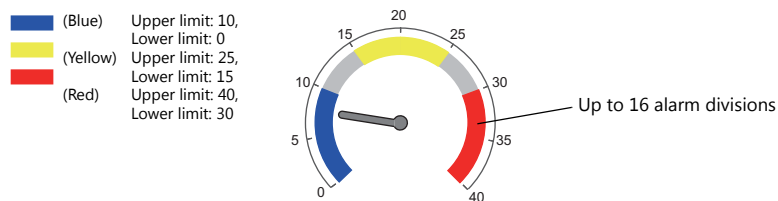
Example: No. of divisions: 3



 For setting examples, refer to ["Displaying Current Values" page 9-28.](#)

- Extended indicator/scale settings
- The design of the scale or indicator can be changed using a PNG file prepared by the user.

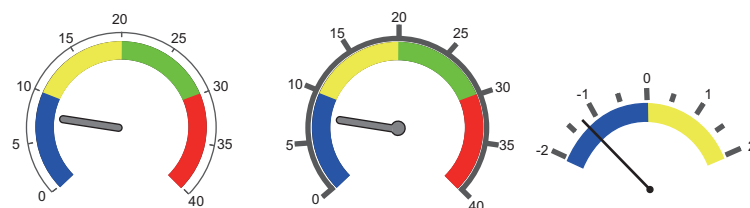

 For setting examples, refer to ["Using Image Files for the Indicator and Scale" page 9-43.](#)

- Numerical data display
- The current data can be displayed on the panel meter in numerical format.
- Example: When "8" is set in the device memory address D100

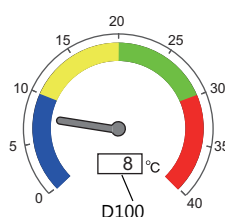

## 9.4.2 Setting Examples

### Displaying Current Values

The current value of a device memory within the range of the minimum and maximum values can be displayed.

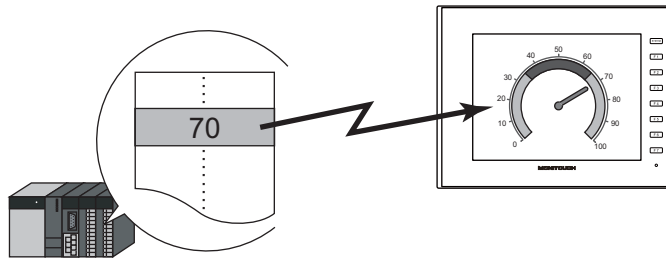

1. Click [Parts] → [Graph] → [Panel Meter] and place a panel meter on the screen.

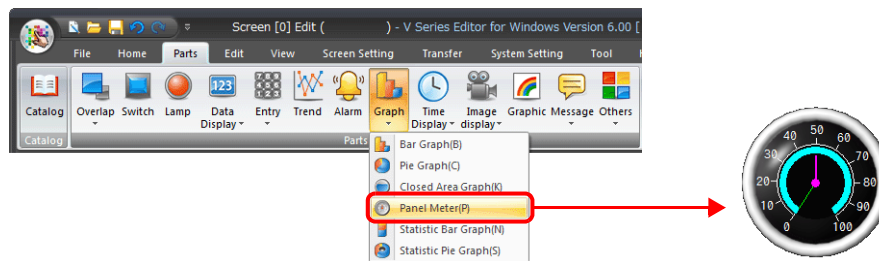

2. Double-click on the panel meter to display the settings window. Configure the [Contents] settings as shown below.
  - Set the device memory address to display on the panel meter with [Current Value] → [Device].
  - Select the direction of indicator movement with [Operation Setting] → [Progress Direction].
  - Specify the graph display area using [Display Setting] → [Range].

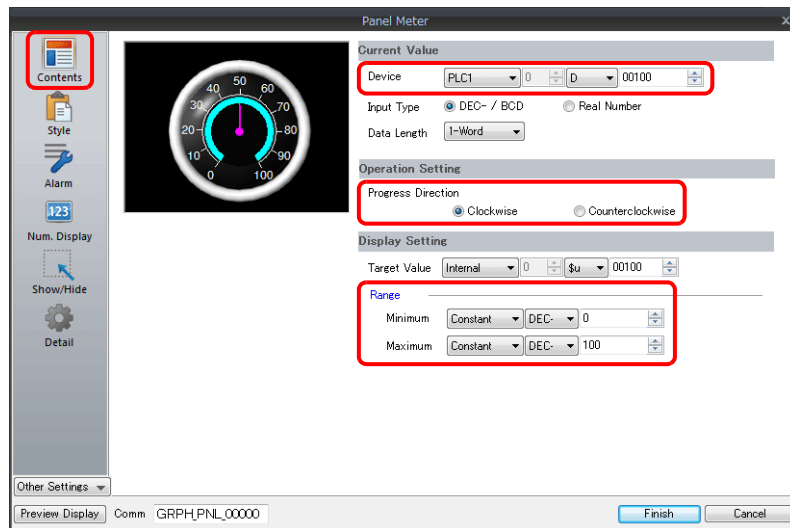

3. Configure the following settings for [Style] and then click [Finish].
  - Set the meter shape and color on the [Design] → [Meter] tab.
  - Set the indicator shape and color on the [Design] → [Indicator] tab.
  - Set the scale shape and color on the [Design] → [Scale] tab.
 To change the panel meter color depending on the value, proceed to step 4.

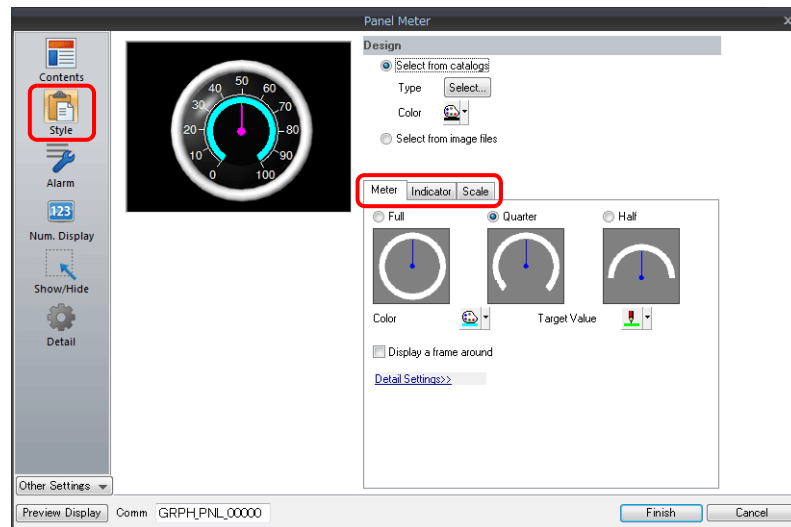

4. Configure the [Alarm] settings to change the indicator and meter color depending on the value.
  - When [Indicator] is selected for [Alarm Setting] → [Alarm Color Target]
    - Set the three colors of the indicator, two colors of the meter area, and range. In this case, color settings set on the [Meter] and [Indicator] tabs in the [Style] settings are disabled.

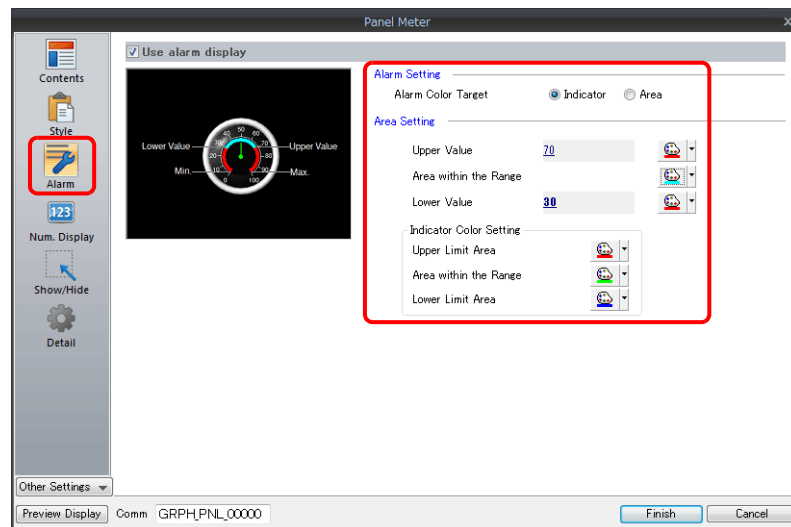

- When [Area] is selected for [Alarm Setting] → [Alarm Color Target]  
Set the color of the meter area and the range. (Up to 16 divisions)  
In this case, color settings set on the [Meter] tab in the [Style] settings are disabled.

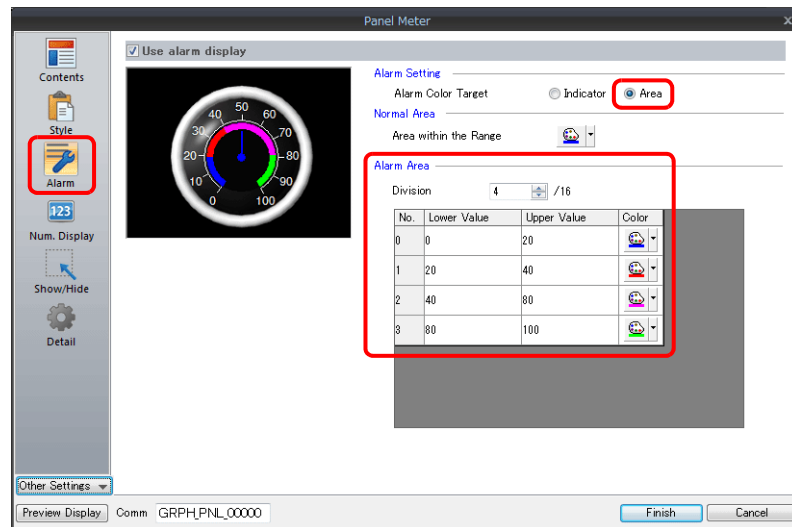

This completes the necessary settings.

## 9.4.3 Detailed Settings

### Contents

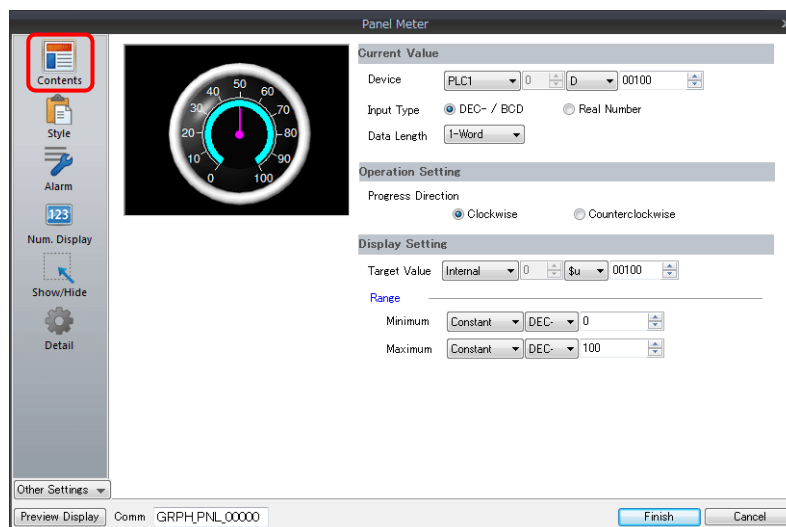

	Item	Description
Current Value	Device	Specify the device memory address to monitor.
	Input Type (DEC- / BCD, Real Number)	Select the data format of device memory values. The selection here also applies to the values of [Range] and [Alarm]. * When [DEC-/BCD] is selected, the setting at [Code: DEC/BCD] under [Communication Setting] in the [PLC Properties] window accessible via [System Setting] → [Hardware Setting] takes effect.
	Data Length (1-Word, 2-Word)	Select data length of the device memory.
Operation Setting	Progress Direction (Clockwise, Counterclockwise)	Select the direction of indicator movement.
Display Setting	Target Value	Display a line at the position of the target value on the panel meter. * If a value less than the minimum value of the range is set, a line is not displayed. * If [Alarm] is configured, the [Standard] or [Target Value] setting is disabled.
	Range (Maximum, Minimum)	Specify the minimum and maximum values for the display range of the panel meter. If the display range is variable, select a device memory. If the display range is fixed, specify a constant.



## Style

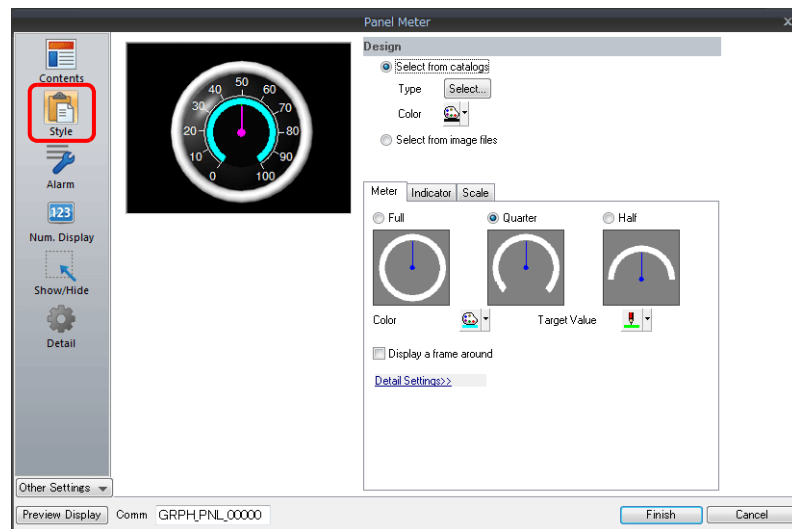

Item		Description
Design	Select from catalogs	Type Set the part design. Color Set the part color.
	Select from image files	Load an image file.
	Meter	Set the color and size of the meter. For details, refer to <a href="#">"Meter" page 9-33</a> .
	Indicator	Set the color and size of the indicator. For details, refer to <a href="#">"Indicator" page 9-34</a> .
	Scaling	Set the color, size, and number of divisions for the scale. For details, refer to <a href="#">"Scaling" page 9-35</a> .

# Meter

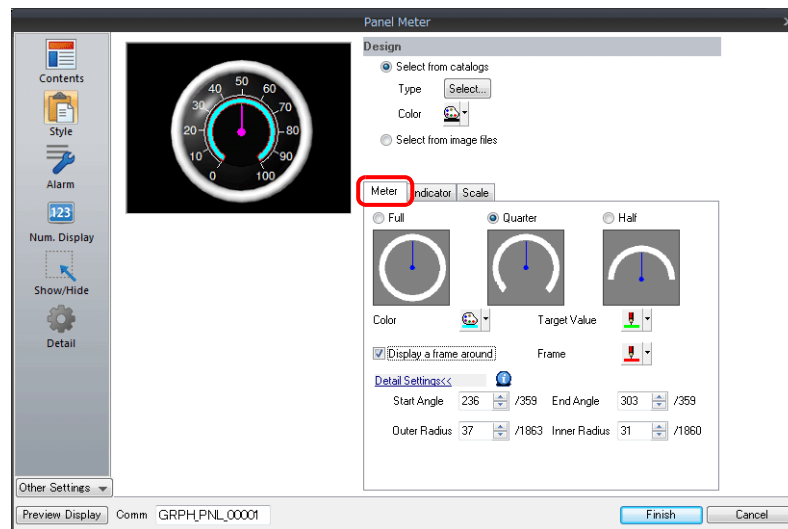

Item	Description	
Full, Quarter, Half	Select the shape of the meter.	
Color	Set the color of the meter.	
Target Value	Set the color of the line displayed for the target value. * If [Alarm] is configured, this is disabled.	
Display a frame around	Select this checkbox to display a frame around the meter. When this checkbox is selected, the frame color can be set.	
Frame	Set the frame color for the meter.	
Customize the size	Set the meter to an arbitrary size.	
Start Angle	Set the start position of the meter.	Example: [Start Angle]: 180, [End Angle]: 0 <p>* The panel meter area is the area circularly enclosed from the start angle to the end angle in the clockwise direction.</p>
End Angle	Set the end position of the meter.	
Outer Radius	The meter comprises the area between the outside and inside circles. The meter width can be adjusted with the outside circle and inside circle radii.	<p>* The inner circle must be set. The minimum radius of the inner circle is 10 pixels. The minimum difference between the radii of the outer and inner circles is 3 pixels.</p>
Inner Radius		

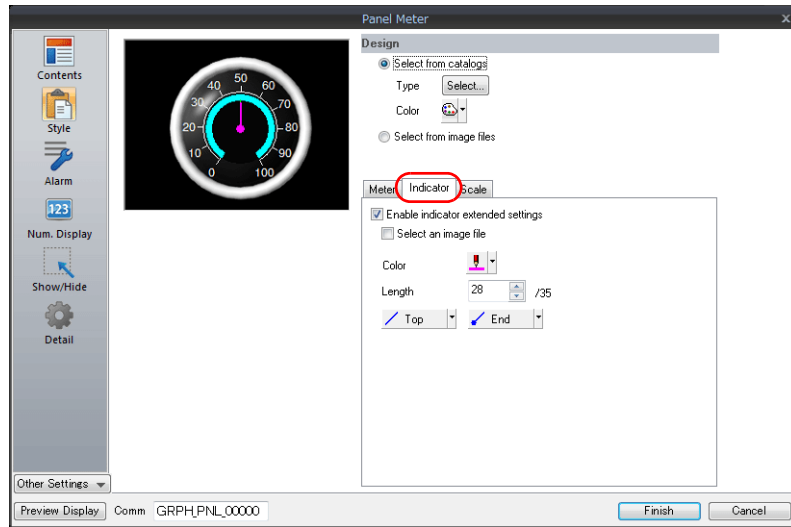

# Indicator

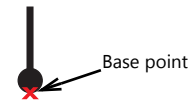
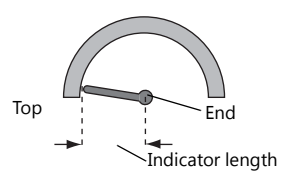
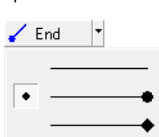

Item	Description	
Enable indicator extended settings	Select this checkbox to specify the indicator's design.	
Select an image file	Select this checkbox to use an image file as the indicator.	
	Select	Select an image file to display as the indicator.
Size Setting	Width	Change the width of the image file.
	Height	Change the height of the image file.
	Fix aspect ratio	Enlarge/reduce the image file with the width and height bound to a fixed aspect ratio.
Position Setting	Base Point X	Adjust the horizontal position of the indicator image.
	Base Point Y	Adjust the vertical position of the indicator image.
	Panel Meter Center Point	Displays the coordinates of the panel meter center point.
	Default	Restore the base position of the indicator image (center bottom edge of the image file) to the center coordinates of the panel meter.
	 <p>* The indicator rotates around the point specified for [Panel Meter Center Point].</p>	
Color	Set the indicator color. * If [Alarm Color Target] is set to [Indicator] in the [Alarm] settings, this is disabled.	
Length	Set the length of the indicator in pixels. (Maximum: Radius of the panel meter; Minimum : 1)	
Top	Select the shape of the indicator tip.	
End	Select the shape of the indicator base.	

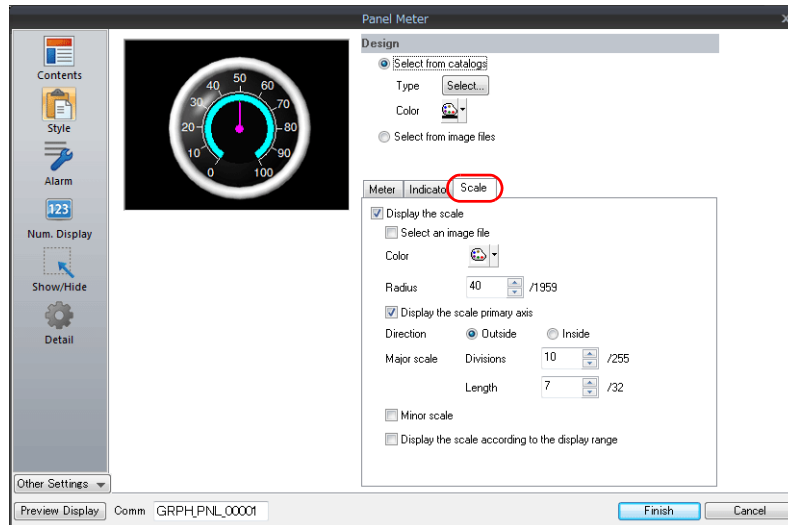
## Scaling

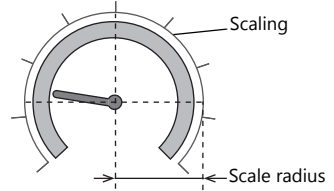
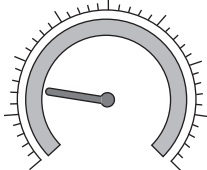

Item	Description	
Display the scale	Select this checkbox to display a scale on the panel meter.	
Select from image files	Select this checkbox to use an image file as the scale.	
Select	Select an image file to display as the scale.	
Size Setting	Width	Change the width of the image file.
	Height	Change the height of the image file.
	Fix aspect ratio	Enlarge/reduce the image file with the width and height bound to a fixed aspect ratio.
Position Setting	Base Point X	Adjust the horizontal position of the scale image.
	Base Point Y	Adjust the vertical position of the scale image.
	Panel Meter Center Point	Displays the coordinates of the panel meter center point.
	Default	Restore the base position of the scale image (center of the image file) to the center coordinates of the panel meter.
Color	Set the scale color.	
Radius	Set the scale size.	
Display the scale primary axis	Select this checkbox to display the primary axis on the scale.	
	With primary axis	No primary axis
		

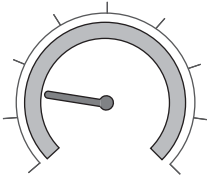
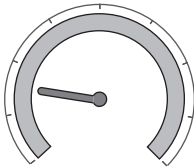
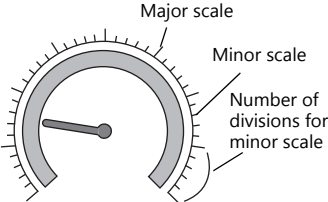
Item		Description	
Direction	Outside	Display tick marks on the outside of the primary axis.	
	Inside	Display tick marks on the inside of the primary axis.	
Major scale	Divisions (1 - 255)	Set the number of divisions on the major scale across the entire scale.	<p>Example: Major scale divisions: 8 Minor scale divisions: 5</p> 
	Length (1 - 16)	Set the length of the major scale. * If using the minor scale, the length increases and decreases by 2.	
Minor scale	Select this checkbox to divide the major scale by the minor scale. * The length of the minor scale is half of the major scale.		
	Divisions (1 - 16)	Set the number of divisions across the major scale.	
Display the scale according to the display range		<p>This is only available for parts that correspond to a numerical display. An optimal scale is displayed according to the minimum and maximum of the value in the range.</p> <p>This setting is only available when the minimum and maximum values are specified with constants. Display numerical values on the scale according to the display range of the panel meter.</p>	

# Alarm

## Alarm color target: indicator

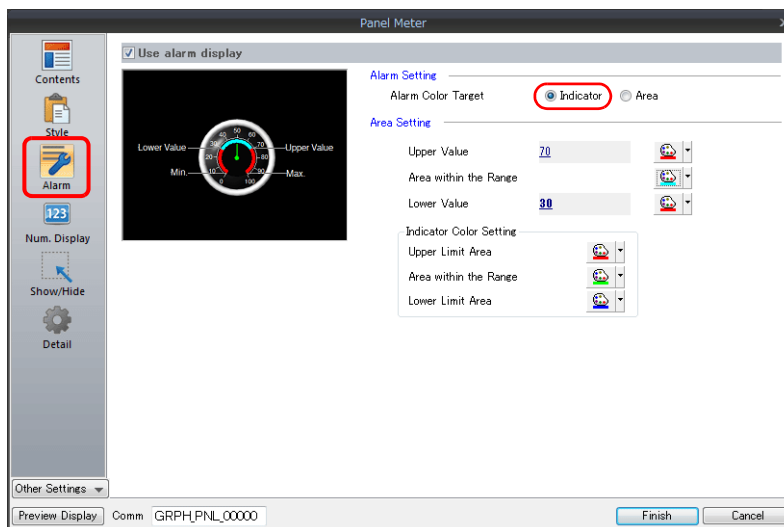

Item		Description	
Use alarm display		Select this checkbox to use the alarm function.	
Alarm Setting	Alarm Color Target	Indicator The indicator color is displayed using three alarm colors according to the upper and lower limit values. The meter is displayed using the two colors for within the range of the upper and lower limits, and outside of the range.	
		Area The meter color can be divided into a maximum of 16 colors according to the [Alarm Area] settings. The indicator color is fixed. For details on settings, refer to <a href="#">"Alarm color target: area" page 9-38</a> .	
Area Setting	Upper Value	Set the color of the meter for the upper limit value and outside the range of the upper and lower limits of the alarm display.	
	Area within the Range	Set the within range color.	
	Lower Value	Set the color of the meter for the lower limit value and outside the range of the upper and lower limits of the alarm display.	
	Indicator Color Setting	Upper Limit Area	Set the indicator color when the current value exceeds the upper limit value.
		Area within the Range	Set the indicator color when the current value is within the range of the upper and lower limits.
Lower Limit Area		Set the indicator color when the current value is less than the lower limit value.	

## Alarm color target: area

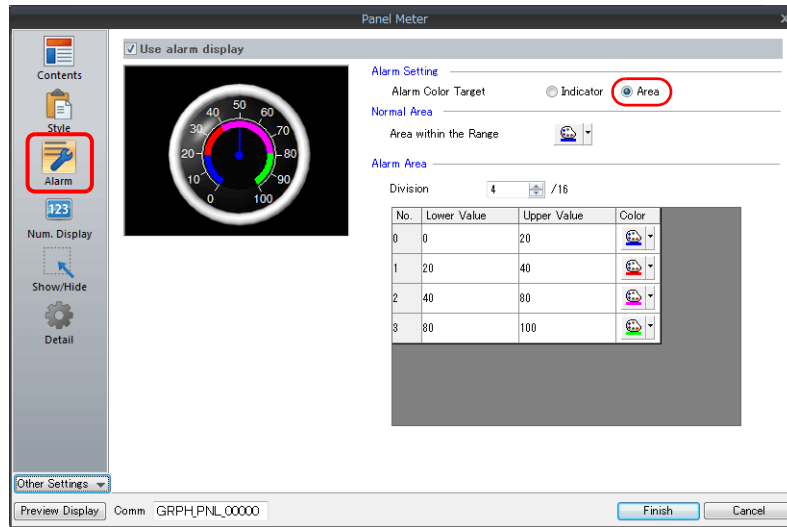

Item		Description	
Use alarm display		Select this checkbox to use the alarm function.	
Alarm Setting	Alarm Color Target	Indicator	The indicator color is displayed using three alarm colors according to the upper and lower limit values. The meter is displayed using the two colors for within the range of the upper and lower limits, and outside of the range. For details on settings, refer to <a href="#">"Alarm color target: indicator"</a> page 9-37.
		Area	The meter color can be divided into a maximum of 16 colors according to the [Alarm Area] settings. The indicator color is fixed.
Normal Area	Area within the Range	Specify the color of the area not included in the alarm range in the display range of the panel meter.	
Alarm Area	Division	Set the number of alarm areas.	
	No. 0 - 15	Lower Value	Set the lower limit value of the alarm area.
		Upper Value	Set the upper limit value of the alarm area.
		Color	Set the display color of the alarm area.
		Example: Divisions: 4, clockwise	<p>* Drawing is performed in order from "Data 0 property" to "Data 15 property". When a range overlaps with another when drawn, the color of the data property with the higher number is displayed in the foreground.</p>

## Num. Display

A panel meter can be set with a numerical data display to show the current value.

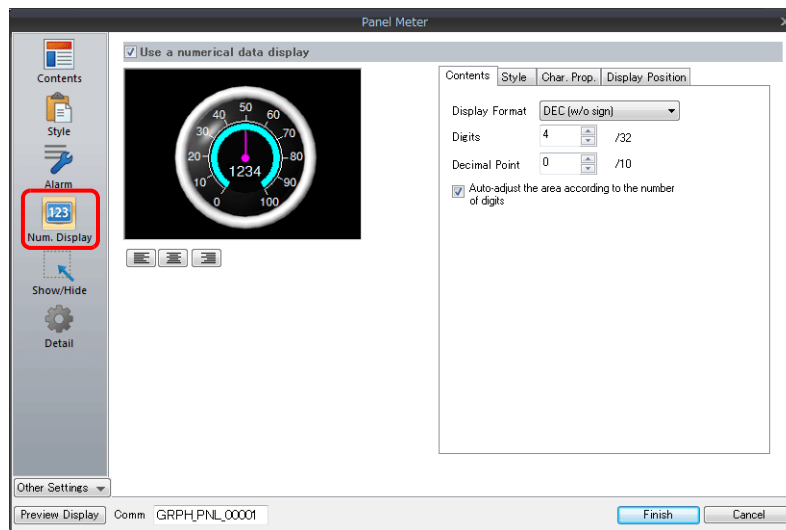

Item	Description
Use a numerical data display	Select this checkbox to display a numerical data display within the panel meter.
Contents	Specify the display format, number of digits, and number of decimal places for the numerical data display. For details, refer to <a href="#">"Contents" page 9-39</a> .
Style	Specify the design of the numerical data display. For details, refer to <a href="#">"Style" page 9-40</a> .
Char. Prop.	Set a text color and size for the numeric data display. For details, refer to <a href="#">"Char. prop." page 9-41</a> .
Display Position	Specify the display position of the numerical data display. For details, refer to <a href="#">"Position" page 9-41</a> .

## Contents

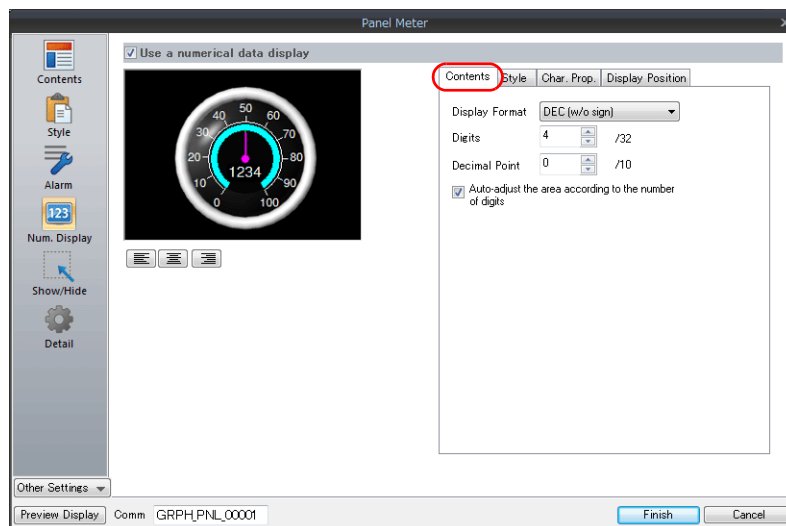

Item	Description
Display	Set the numerical value format.
Digit	Set the number of digits for the numerical data display.
Decimal Point	Set the number of decimal places. When no decimal point is required, set "0".
Auto-adjust the area according to the number of digits	Select this checkbox to automatically adjust the item size based on the [Digit] and [Decimal Point] settings.



## Style

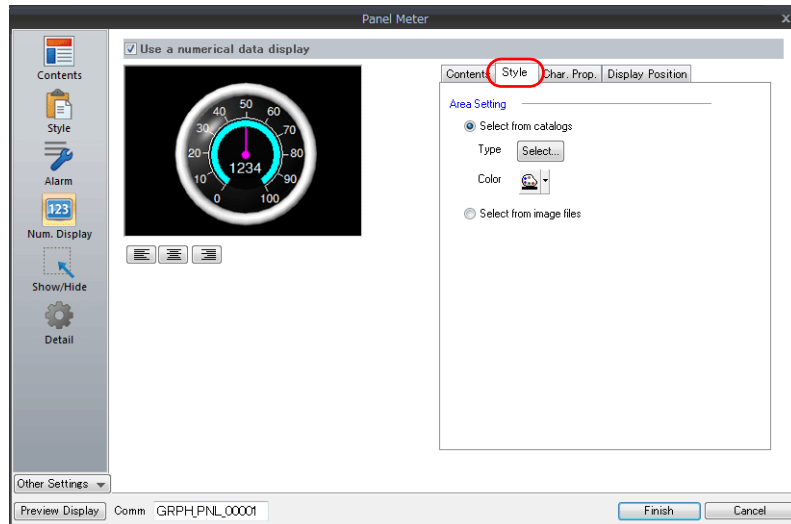

Item		Description
Area Setting	Select from catalogs	Select the design of the numerical data display part to use from the parts catalog. Type Select the design of the numerical data display part. Color Set the color of the numerical data display part.
	Select from image files	Select the design of the numerical data display part from an image file.
	Select	Select the image file to use.
	Width	Change the width of the image file.
	Height	Change the height of the image file.
	Fix aspect ratio	Enlarge/reduce the image file with the width and height bound to a fixed aspect ratio.

### Char. prop.

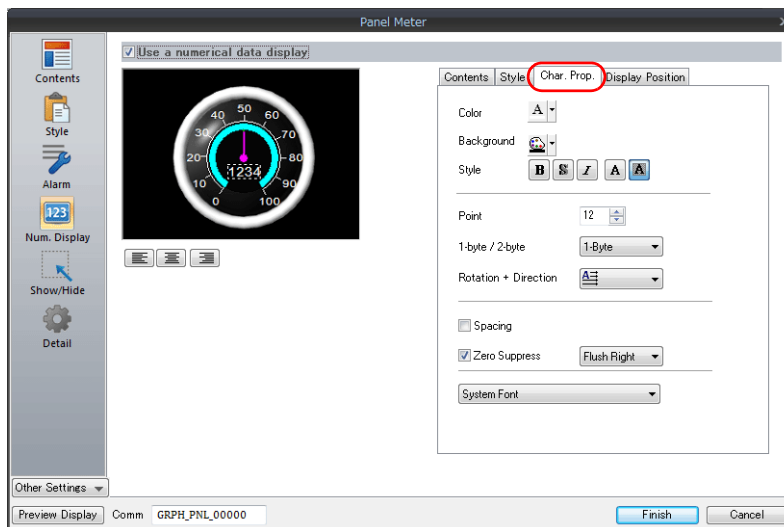

Item	Description
Color	Set the text color.
Background	Set the background color of the numerical data display area.
Style	Set the text style.
Character Size	Set the text size. * This changes to point specification when using a Windows font or 7-segment font.
Rotation +	Set the orientation of text. * This cannot be set when using a Windows font.
Spacing	To set a text spacing, select this checkbox and specify a spacing. * This cannot be set when using a Windows font.
Zero Suppress	To set zero suppression, select this checkbox and select flush left or flush right.
System Font Windows Font 7-segment Font	Select the font of the numerical data display.
Display light-out segments	This setting is available when [7-segment Font] is selected. Select this checkbox to display unlit segments.

### Position

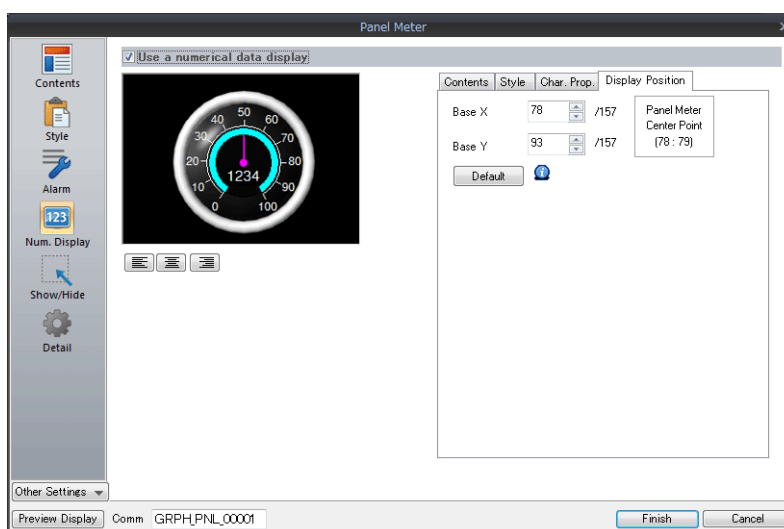

Item	Description
Base X	Adjust the horizontal position of the numerical data display.
Base Y	Adjust the vertical position of the numerical data display.
Panel Meter Center Point	Displays the coordinates of the panel meter center point.
Default	Restore the base position of the numerical data display (center of the item) to the center coordinates of the panel meter.



## Detail

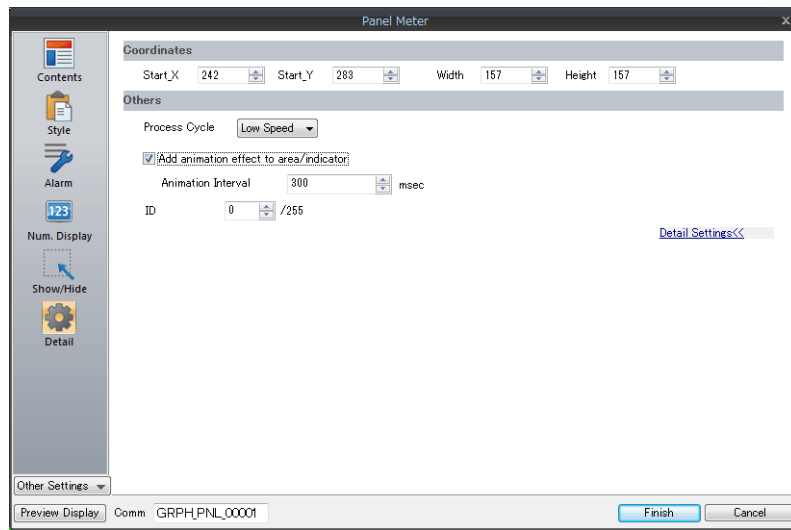

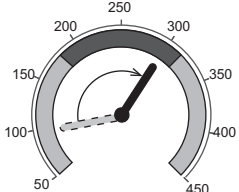
Item		Description	
Coordinates	Start X/Start Y	Specify the placement coordinates. (Coordinates at top left of part)	
	Width/Height	Specify the width and height of the part.	
Others	Process Cycle	Specify the process cycle of the part.	
	Add animation effect to area/indicator	Draw changes in the graph display over the time specified for [Animation Interval].	Example: Animation interval: 200 msec Current value changes from 100 to 300.  Indicator movement occurs over 200 msec.
	Animation Interval	Set the drawing speed of changes in the graph display.	
	ID	Set the ID.	

## Using Image Files for the Indicator and Scale

An image file created by the user can be used for the part design (background, indicator, and scale).

### [Style]

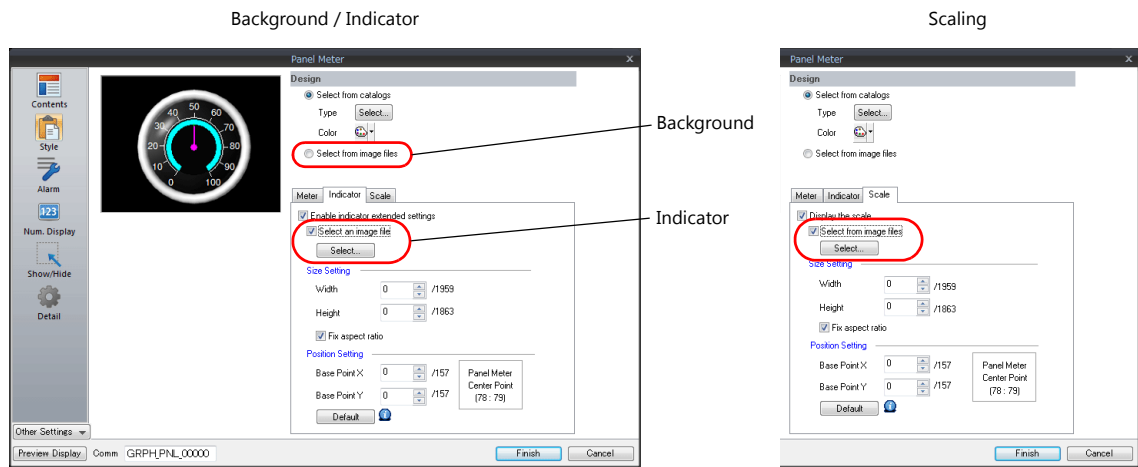

Item	Description
Select from images files (background/indicator/scale)	Select a PNG file from the desired folder. The selected PNG file is stored at ".\MONITOUCH\User\Parts".
Width, Height	Change the width and height of the imported PNG file.
Fix aspect ratio	Select this checkbox to use a fixed width-to-height ratio when changing the size of the PNG file.
Panel Meter Center Point	Displays the coordinate values of the panel meter (circle) center point. <div style="text-align: center;"> </div>
Base Point X/Base Point Y	Specify the X and Y coordinate values of the base point in pixels to adjust the position of the indicator or scale. The indicator rotates around the [Panel Meter Center Point]. <div style="text-align: center;"> </div>
Default	Restore the X and Y coordinate values of the base point to those specified for [Panel Meter Center Point].

## Setting procedure

This section explains the procedure for importing a PNG file into the panel meter.

Background of the panel meter

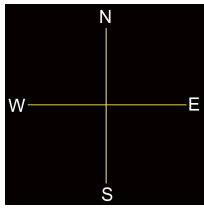

back\_A.png

Scaling

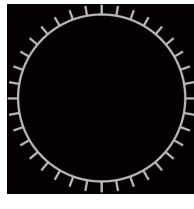

scale\_A.png

Indicator



pin\_A.png

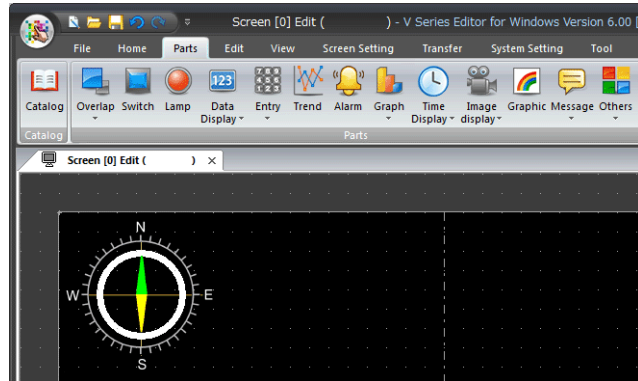

1. Place a panel meter on the screen.

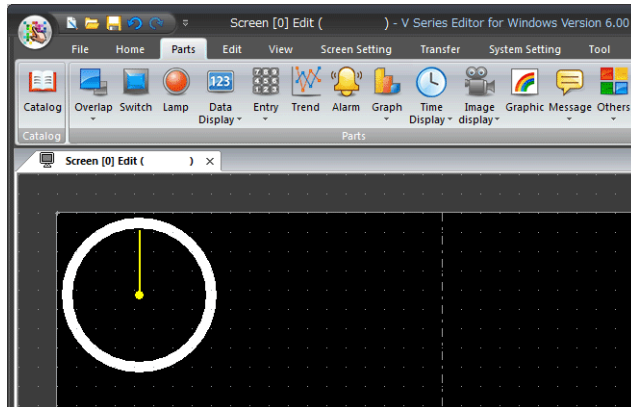

2. Import a background image for the panel meter.

Select the [Style] → [Design] → [Select from image files] radio button in the settings window and click the [Select] button to select an image file (e.g. back\_A.png).

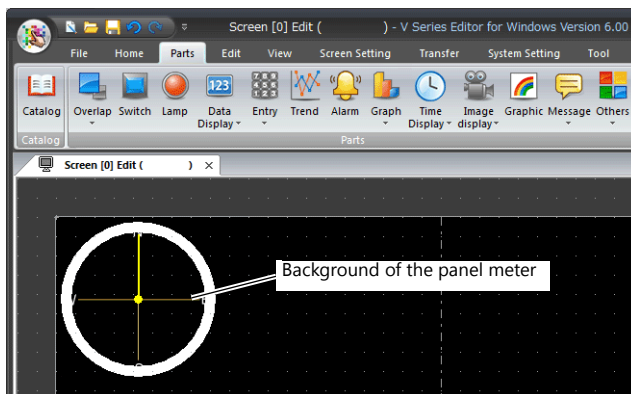

3. Select the [Style] → [Meter] → [Detail Settings] in the settings window to enlarge or reduce the size using the [Outer Radius] and [Inner Radius] values.

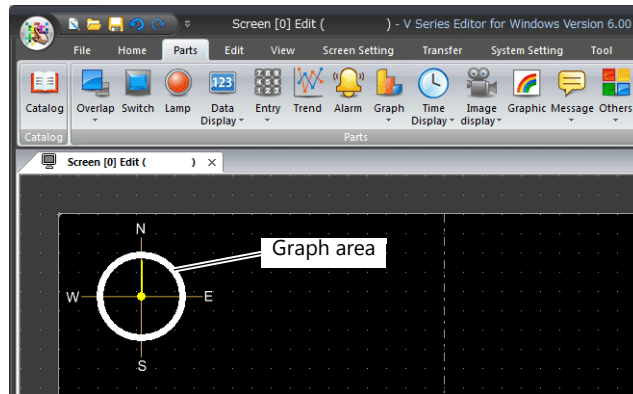

4. Import a PNG image for the indicator.  
Select the [Style] → [Indicator] → [Select an image file] checkbox in the settings window and click the [Select] button to select an image file (e.g. pin\_A.png).

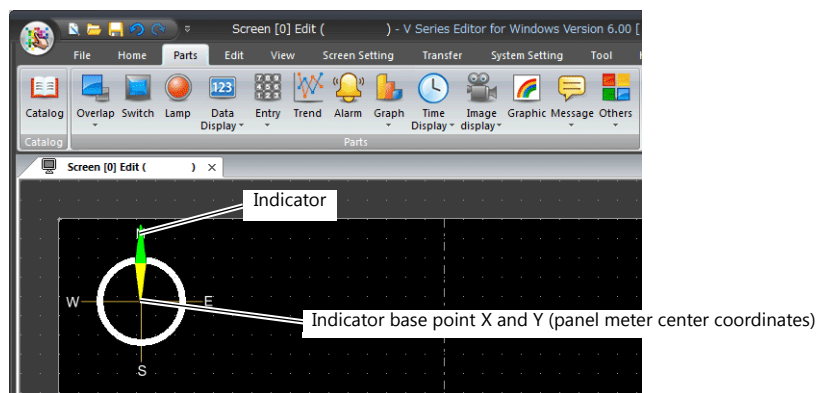

\* **The PNG image of the indicator is imported while it is pointing upward with reference to the panel meter center point. The indicator cannot be rotated on the editor.**

5. Move the indicator part downward by specifying values for [Base Point X] and [Base Point Y] on the [Style] → [Indicator] tab.  
The indicator can be enlarged or reduced by specifying values for [Width] and [Height].

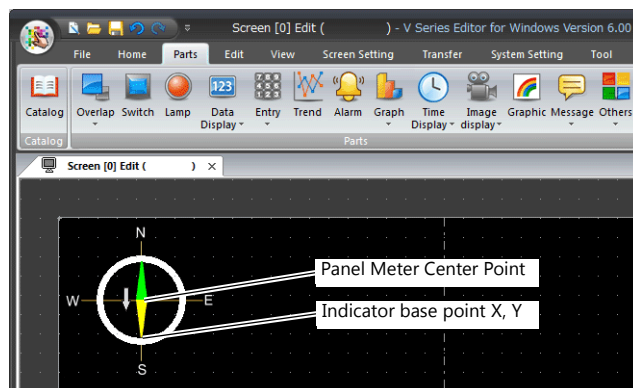

\* **The indicator rotates around the panel meter center point.**

- Import a PNG image of the scale.

Select the [Style] → [Scale] → [Display the scale] → [Select an image file] checkbox in the settings window and click the [Select] button to select an image file (e.g. scale\_A.png).

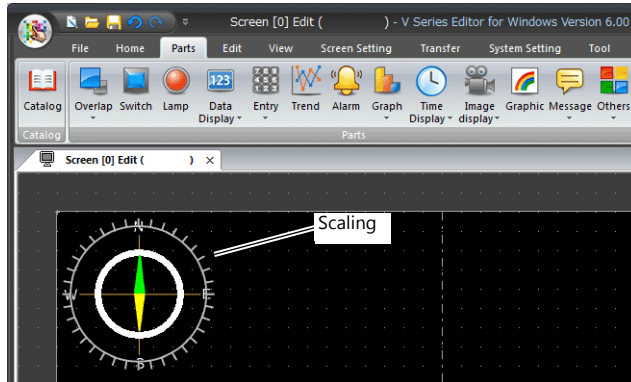

- Specify values for [Width] and [Height] on the [Style] → [Scale] tab to reduce the size of the scale. The position of the scale can be moved by specifying values for [Base Point X] and [Base Point Y].

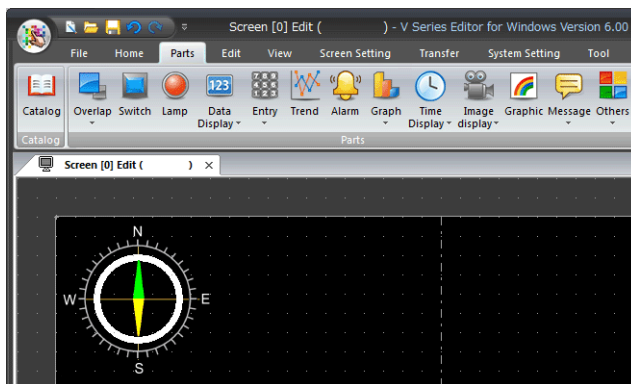

This completes the necessary settings.

## Restrictions

- The order of drawing is shown below. Drawing is performed in ascending order.

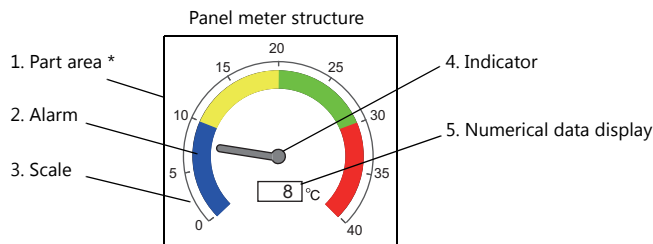

\* When a draw item edited in the [Modify Part] window is placed on a 3D panel meter part, the item is placed over the panel meter.

- The numerical data display is displayed even when a value falls outside the range specified for [Scale] (specified at [Contents] → [Range]). However, if the number of digits exceeds the specified value, "---" is displayed.

## 9.5 Statistic Bar Graph

### 9.5.1 Overview

- Percentages of data contained in consecutive device memory addresses can be expressed on a graph. One statistic bar graph can be divided into a maximum of eight sections.
  - For setting examples, refer to [“Displaying a Bar Graph of the Ratio of D100 to D104 Values”](#) page 9-48.
- It is also possible to indicate percentages as numerical values for the statistic bar graph. In this case, the statistic bar graph must be linked to a numerical data display.
  -

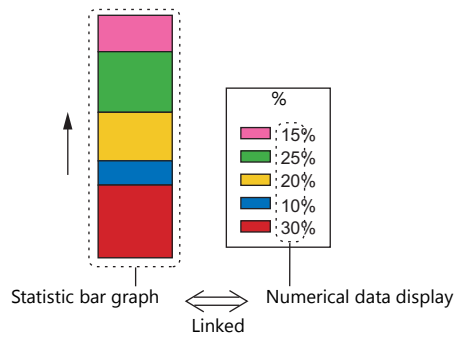

- For setting examples, refer to [“Displaying a Numerical Data Display of the Ratio of D100 to D104 Values”](#) page 9-49.



## 9.5.2 Setting Examples

### Displaying a Bar Graph of the Ratio of D100 to D104 Values

The following example shows how to display the ratio between the values of five device memory addresses on a bar graph.

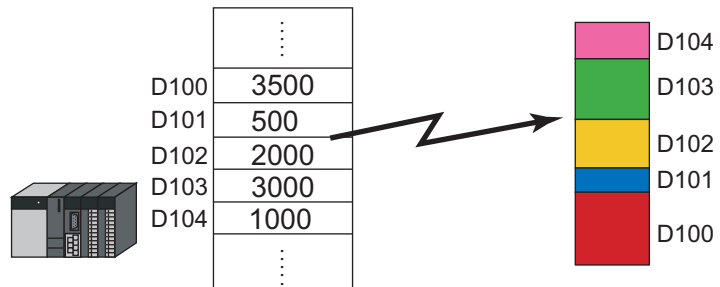

1. Click [Parts] → [Graph] → [Statistic Bar Graph] and place a statistic bar graph on the screen.

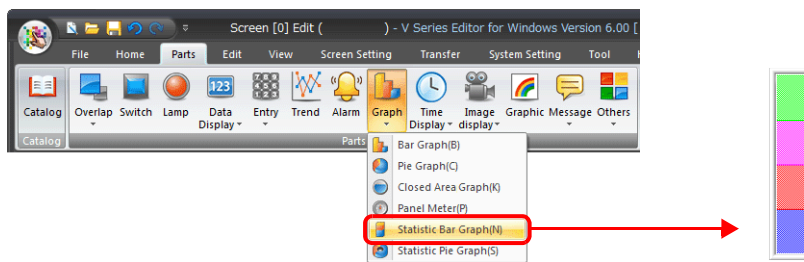

2. Double-click on the statistic bar-graph to display the settings window. Configure the [Contents] settings as shown below.
  - Set the top device memory address to display on the graph with [Top Data] → [Device].
  - Set the number of device memory addresses to display on the graph with [Display Setting] → [Number of Data to Display].
  - Set the color of each device memory on the graph display with [Display Setting] → [Color Setting for Data].

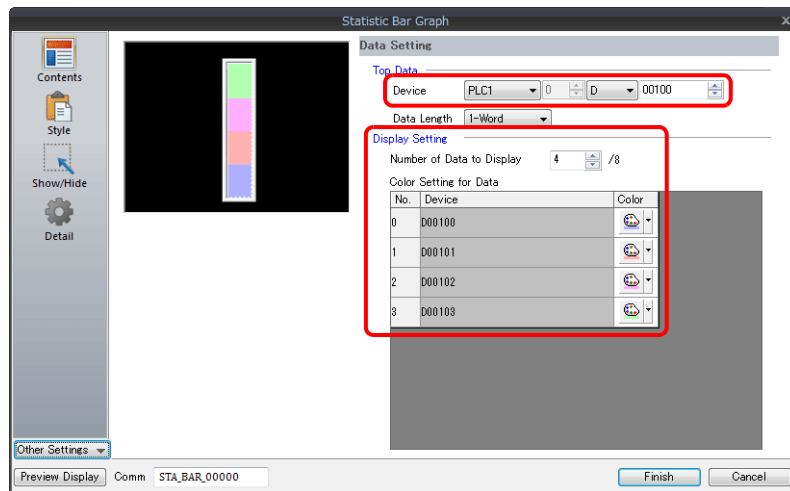

This completes the necessary settings.

## Displaying a Numerical Data Display of the Ratio of D100 to D104 Values

The following example shows how to display the ratio between the device memory addresses displayed on the statistic bar graph on a numerical data display.

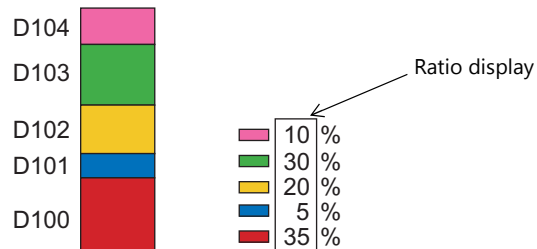

1. Click [Parts] → [Graph] → [Statistic Bar Graph] and place a statistic bar graph on the screen.

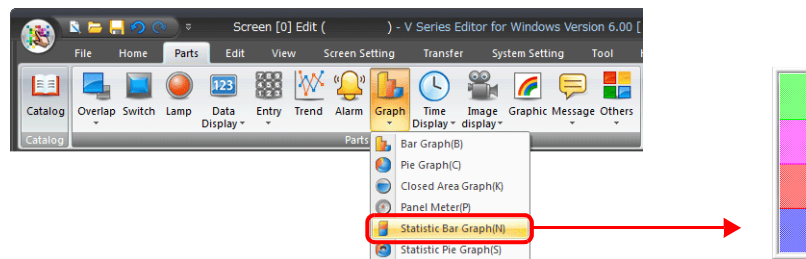

2. Double-click on the statistic bar-graph to display the settings window. Select [Num. Display] under [Add Parts] in the [Style] settings.

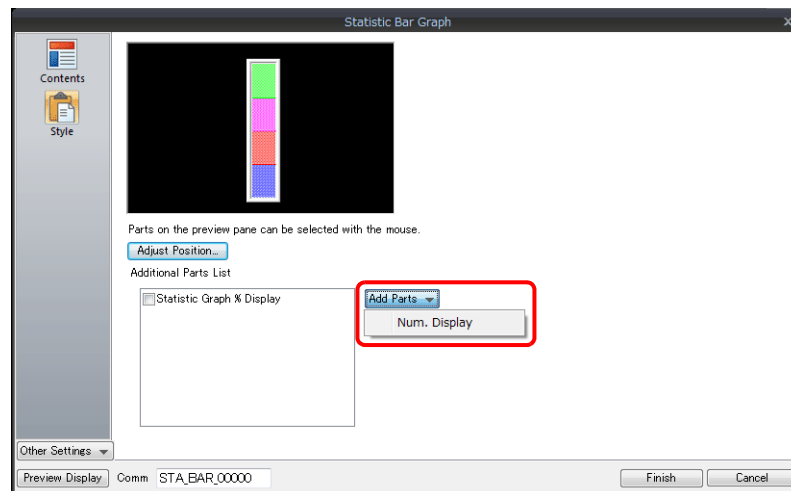

3. The settings window for the numerical data display is displayed. Select [Statistic Graph % Display] for [Function] and specify a value for [Statistic Graph No.]. Click [Finish] to close the settings window of the numerical data display.

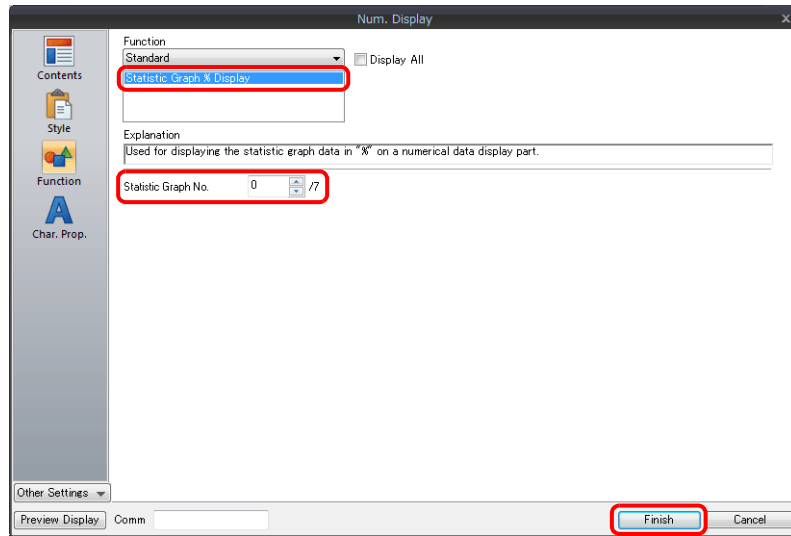

4. Repeat steps 2 and 3 to place multiple numerical data displays.

This completes the necessary settings.

## 9.5.3 Detailed Settings

### Contents

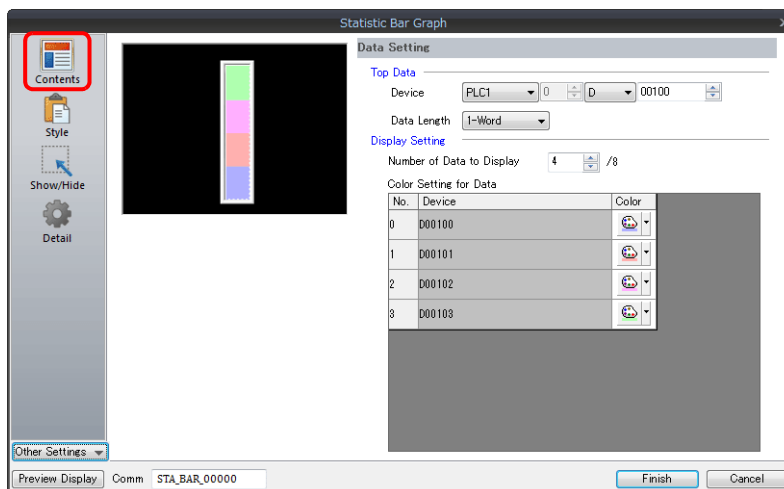

Item		Description	
Data Setting	Top Data	Device	Set the top device memory address to display on the statistic graph. The required device memory are automatically allocated to the statistic graph. * The data format relies on the setting at [Code: DEC/BCD] under [Communication Setting] in the [PLC Properties] window accessible via [System Setting] → [Hardware Setting].
		Data Length (1-Word, 2-Word)	Select data length of the device memory.
	Display Setting	Number of Data to Display	Set the number of device memory to display on the statistic graph.
		Color Setting for Data	Set the color for each data memory displayed on the statistic graph.

### Style

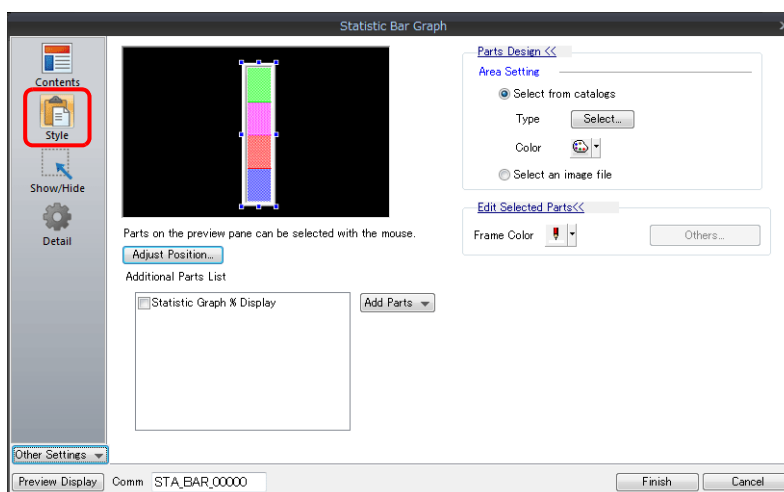

Item		Description	
Select from catalogs		Type	Set the part design.
		Color	Set the part color.
Select an image file		Load an image file.	
Frame Color		Set the color of the frame around the graph area.	
Additional Parts List	Statistic Graph % Display	Add [Statistic Graph % Display].	
Add Parts	Num. Display	Add a numerical data display part.	

## Detail

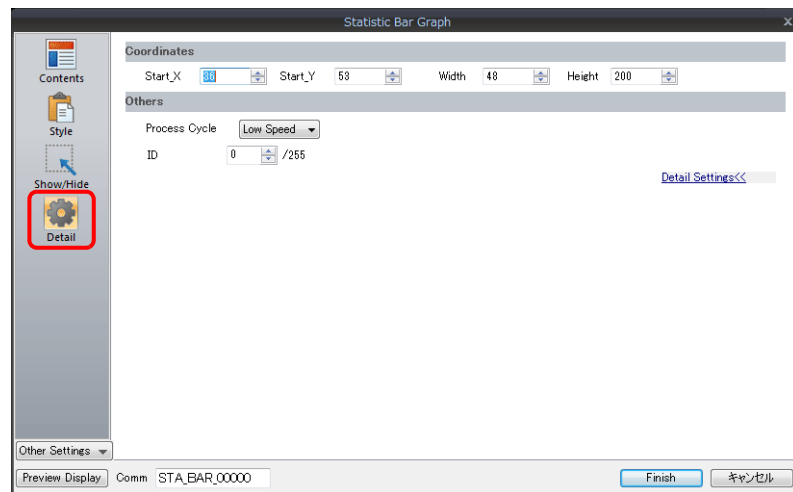

Item		Description
Coordinates	Start X/Start Y	Specify the placement coordinates. (Coordinates at top left of part)
	Width/Height	Specify the width and height of the part.
Others	Process Cycle	Specify the process cycle of the part.
	ID	Set the ID.

## 9.6 Statistic Pie Graph

### 9.6.1 Overview

- Percentages of data contained in consecutive device memory addresses can be expressed on a graph. One statistic pie graph can be divided into a maximum of eight sections.
  - For setting examples, refer to [“Displaying a Pie Graph of the Ratio of D100 to D103 Values”](#) page 9-54.
- It is also possible to indicate percentages as numerical values for the statistic pie graph. In this case, the statistic pie graph must be linked to a numerical data display.

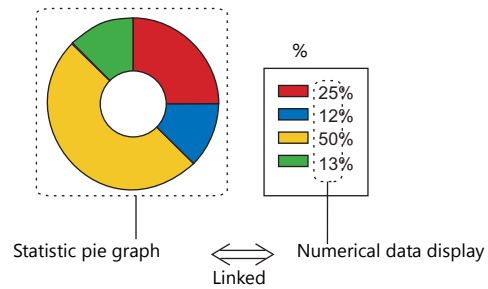

- For setting examples, refer to [“Displaying a Numerical Data Display of the Ratio of D100 to D103 Values”](#) page 9-55.

## 9.6.2 Setting Examples

### Displaying a Pie Graph of the Ratio of D100 to D103 Values

The following example shows how to display the ratio between the values of four device memory addresses on a pie graph.

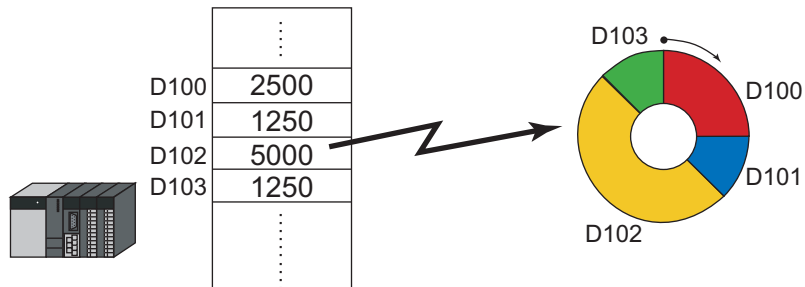

1. Click [Parts] → [Graph] → [Statistic Pie Graph] and place a statistic pie graph on the screen.

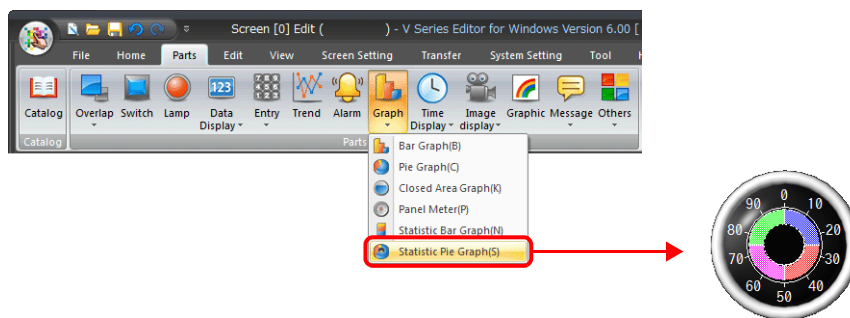

2. Double-click on the statistic pie graph to display the settings window. Configure the [Contents] settings as shown below.
  - Set the top device memory address to display on the graph with [Top Data] → [Device].
  - Set the number of device memory addresses to display on the graph with [Display Setting] → [Number of Data to Display].
  - Set the color of each device memory address on the graph display with [Display Setting] → [Color Setting for Data].

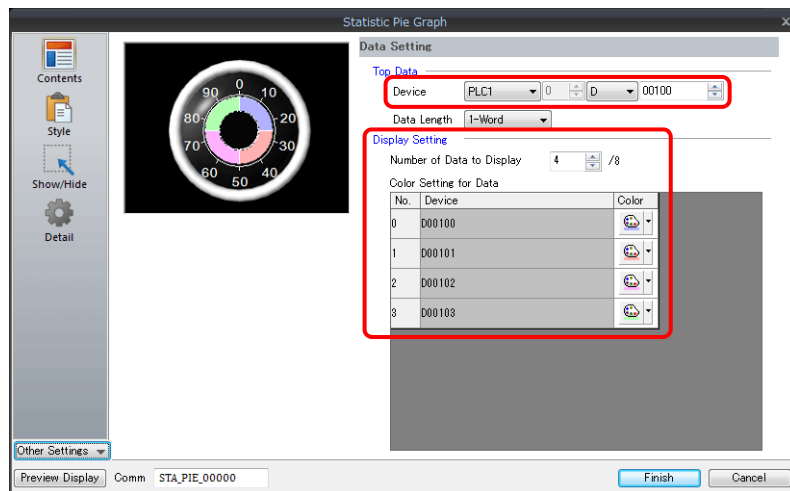

This completes the necessary settings.

## Displaying a Numerical Data Display of the Ratio of D100 to D103 Values

The following example shows how to display the ratio between the device memory addresses displayed on the statistic pie graph on a numerical data display.

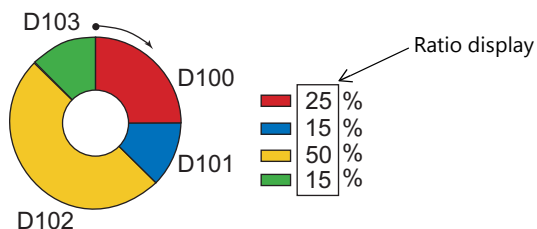

1. Click [Parts] → [Graph] → [Statistic Pie Graph] and place a statistic pie graph on the screen.

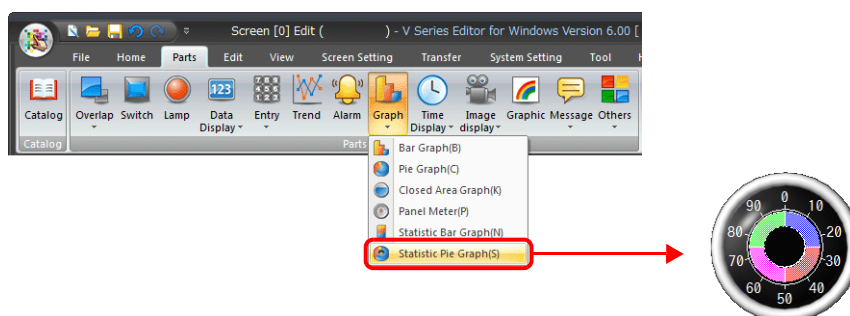

2. Double-click on the statistic pie graph to display the settings window. Select [Num. Display] under [Add Parts] in the [Style] settings.

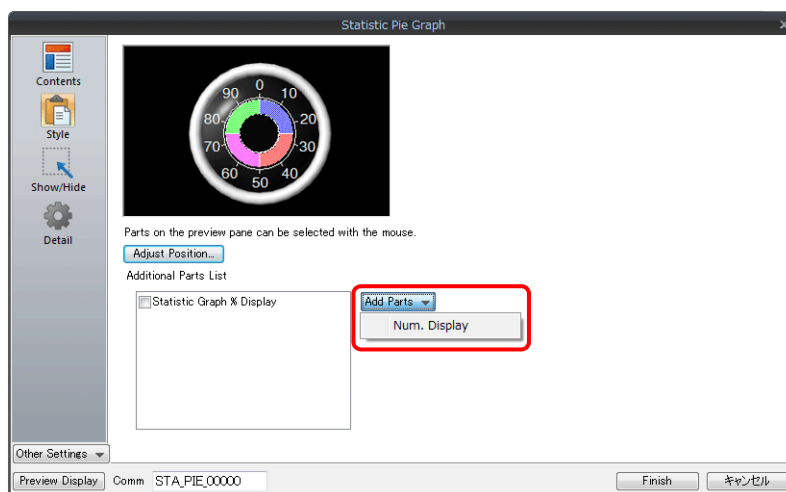



3. The settings window for the numerical data display is displayed. Select [Statistic Graph % Display] for [Function] and specify a value for [Statistic Graph No.]. Click [Finish] to close the settings window of the numerical data display.

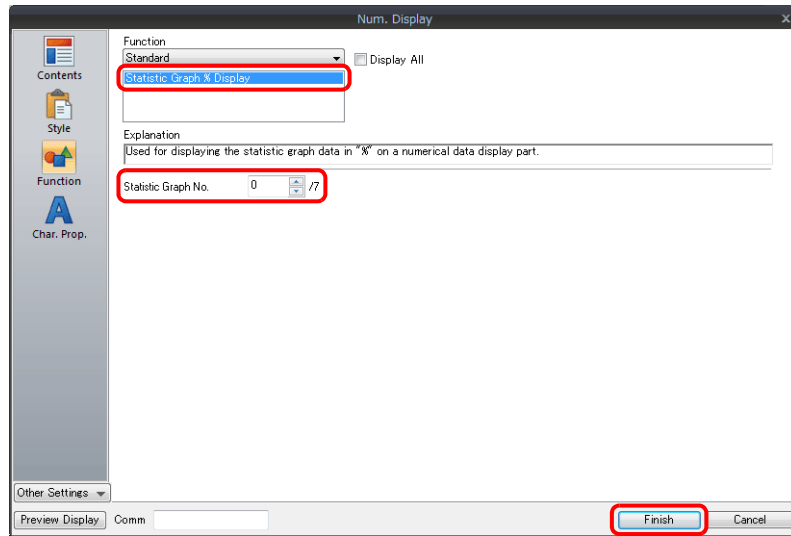

4. Repeat steps 2 and 3 to place multiple numerical data displays.

This completes the necessary settings.

## 9.6.3 Detailed Settings

### Contents

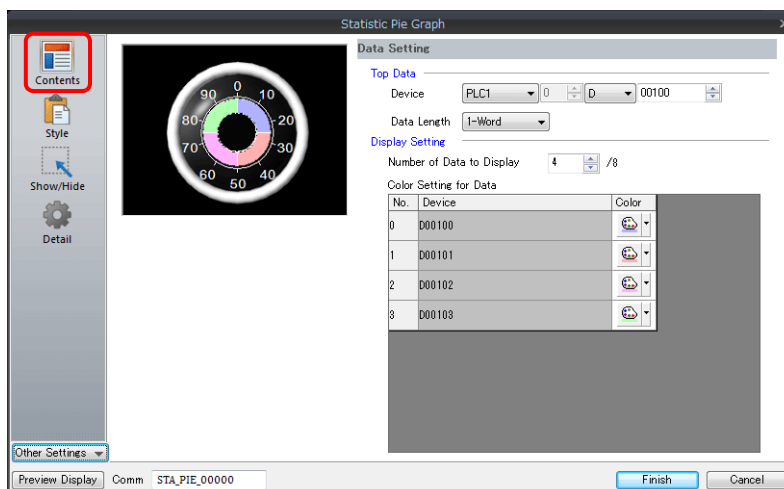

Item			Description
Data Setting	Top Data	Device	Set the top device memory address to display on the statistic graph. The required device memory are automatically allocated to the statistic graph. * The data format relies on the setting at [Code: DEC/BCD] under [Communication Setting] in the [PLC Properties] window accessible via [System Setting] → [Hardware Setting].
		Data Length (1-Word, 2-Word)	Select data length of the device memory.
	Display Setting	Number of Data to Display	Set the number of devices to display on the statistic graph.
		Color Setting for Data	Set the color for each data displayed on the statistic graph.

### Style

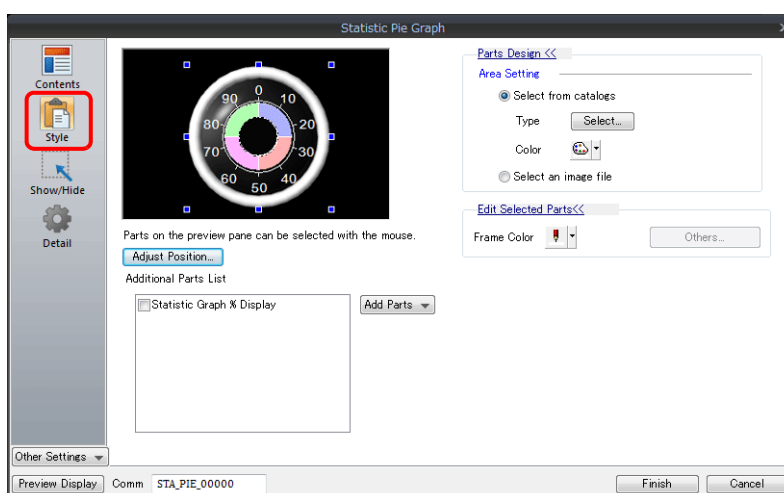

Item		Description
Select from catalogs	Type	Set the part design.
	Color	Set the part color.
Select an image file		Load an image file.
Frame Color		Set the color of the frame around the graph area.
Additional Parts List	Statistic Graph % Display	Add [Statistic Graph % Display].
Add Parts	Num. Display	Add a numerical data display part.

## Detail

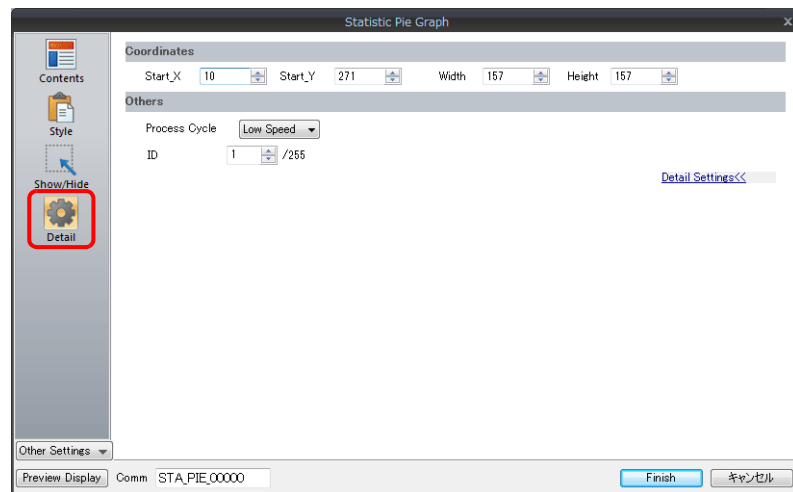

Item		Description
Coordinates	Start X/Start Y	Specify the placement coordinates. (Coordinates at top left of part)
	Width/Height	Specify the width and height of the part.
Others	Process Cycle	Specify the process cycle of the part.
	ID	Set the ID.

# 10 Calendar

---

10.1 Overview

10.2 Time Display

10.3 Calendar

10.4 Calendar Data Correction

## 10.1 Overview

- The calendar part is used to show the year, month, day, hour, minute, second, and day of the week on the screen.
- The range of the calendar display on the V9 series is from 01/01/2012 to 19/01/2038.
- On the V9 series, "21.04.14 9:00:00" is displayed when the power is turned on immediately after purchase (before communication with a PLC with a calendar function and before using the built-in calendar of the V9 series).

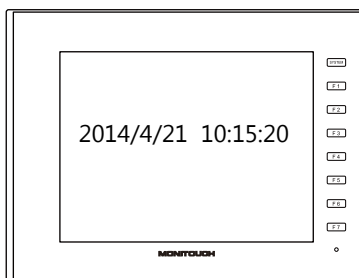

- Depending on the calendar data to be used, the setting and correction methods vary. Refer to the following table.

	PLC Calendar <sup>*1</sup>	V9 Series Calendar <sup>*2</sup>	User Format <sup>*3</sup>
Part	<ul style="list-style-type: none"> <li>• Time display</li> <li>• Calendar</li> </ul>	<ul style="list-style-type: none"> <li>• Time display</li> <li>• Calendar</li> </ul>	<ul style="list-style-type: none"> <li>• Time display</li> </ul>
Required Settings	Connected device settings <sup>*1</sup> [Calendar] and SRAM/clock settings <sup>*4</sup> Built-in clock not used	SRAM/clock settings <sup>*4</sup>	Time display format setting
At Power ON	The PLC calendar <sup>*1</sup> is automatically read and displayed.	The V9 series calendar is displayed.	Data in the device memory set for the time display part is read and displayed.
RUN Mode	V9 series CPU clock	V9 series CPU clock	
Auto Correction	The PLC calendar <sup>*1</sup> is automatically read when the date is changed.	–	–
Correction	The bit of the device memory set for the calendar is turned ON. or Macro: SET_CLND ..... PLC1 PLC_CLND <sup>*5</sup> ..... PLC2 - 8	Main Menu screen or Macro: SET_SYS_CLND	–
Backup at Power OFF	×	○	×

<sup>\*1</sup> PLC calendar: Calendar that the PLC retains in the CPU

Because a maximum of 8-way communication is possible on the V9 series, the PLC calendar data to be read must be determined. This can be configured using the [Calendar] setting at [System Setting] → [Hardware Setting] → [Control Area]. When [PLC Selection] is set to [PLC1], the calendar of PLC1 is read; when [PLC Selection] is set to [PLC3], the calendar of PLC3 is read. However, if the PLC specified for [PLC Selection] is not equipped with a built-in calendar, it is regarded as "no calendar".

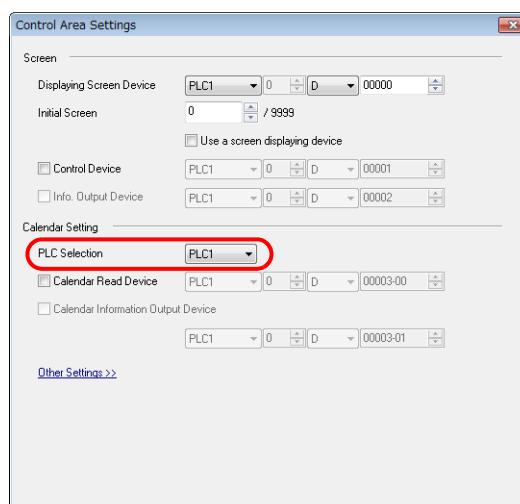

<sup>\*2</sup> V9 series calendar: Calendar on the V9 series unit

<sup>\*3</sup> User format: Calendar in the user-defined format created in the PLC

- \*4 SRAM/Clock Setting  
Always set this option when using the built-in calendar in the V9 series unit.

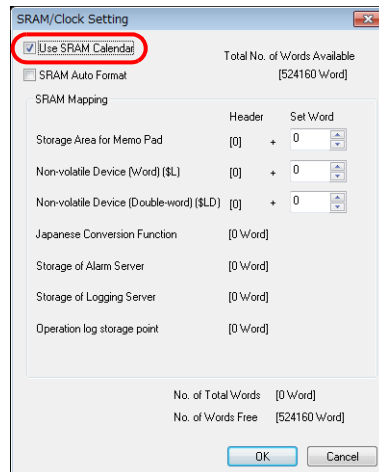

- Select [System Setting] → [Unit Setting] → [SRAM/Clock] and select the [Use SRAM Calendar] checkbox.
- Always install a backup battery.

For details on batteries, refer to the V9 Series Hardware Specifications Manual.

- \*5 In the case of PLC2 to PLC8, calendar correction is performed by the execution of macro commands “PLC\_CLND” and “SYS (SET\_SYS\_CLND)”.
- When the bit of the device set for calendar reading is turned ON, the calendar data of the PLC specified for [Calendar] will be read as explained in Note 1 (\*1).

For details, refer to the V9 Series Macro Reference Manual.

## 10.2 Time Display

### 10.2.1 Overview

- Displays the PLC clock.

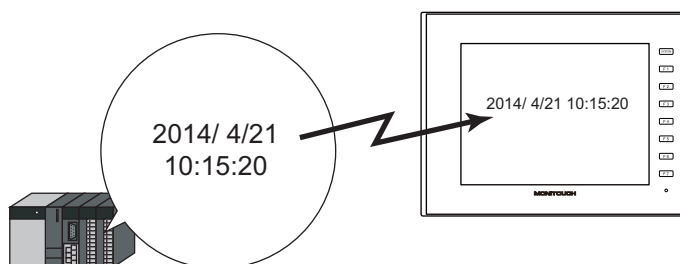

For setting examples, refer to [“Displaying the PLC Calendar”](#) page 10-4.

- Displays the V9 series unit clock.

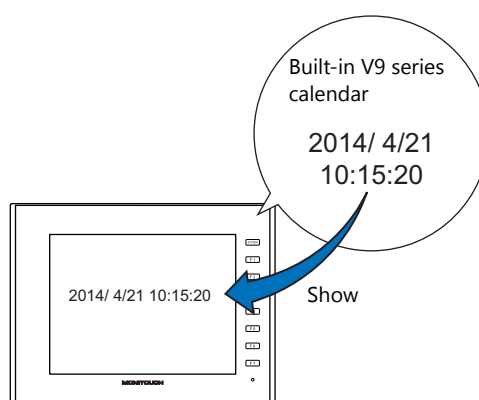

For setting examples, refer to [“Displaying the Built-in V9 Series Calendar”](#) page 10-6.

- Displays the values of consecutive device memory addresses as the time.

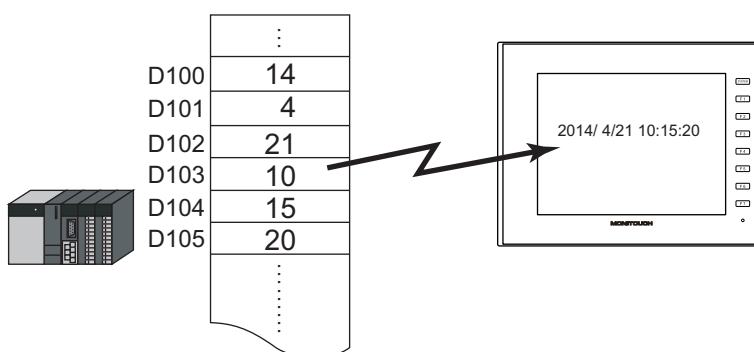

For setting examples, refer to [“Display Using the Time Display Format Setting”](#) page 10-8.

- Displays the seconds data stored in device memory in timer format.

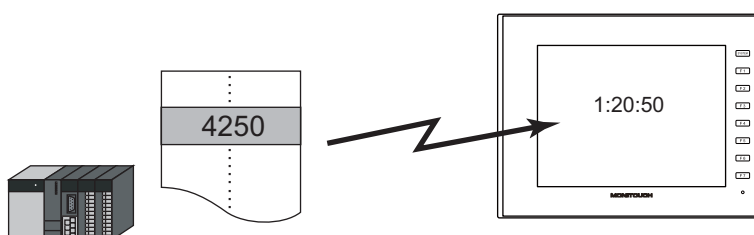

For setting examples, refer to [“Displaying Seconds Data Stored in Device Memory in Timer Format”](#) page 10-10.

## 10.2.2 Setting Examples

### Displaying the PLC Calendar

Display the PLC's built-in calendar on the V9 series unit.

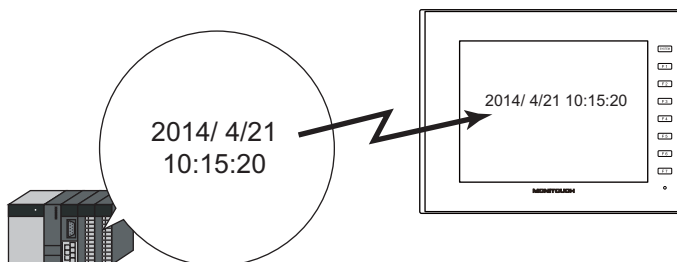

1. Click [System Setting] → [Hardware Setting] → [Control Area].

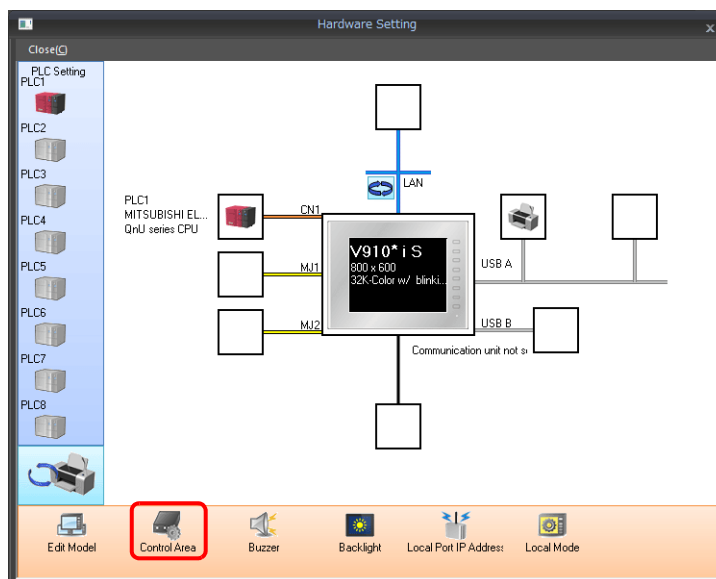

2. Set the PLC to use at [PLC Selection] under [Calendar Setting].

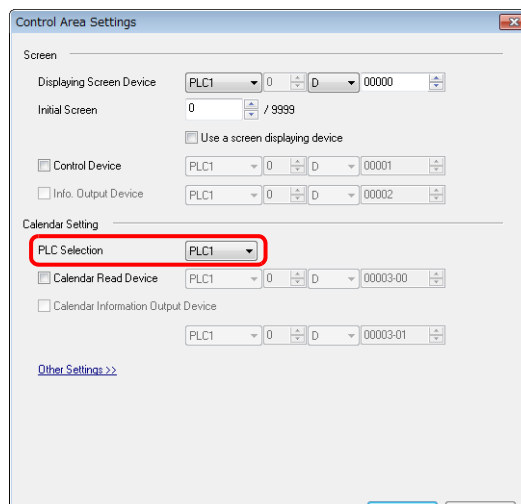



3. Click [System Setting] → [Unit Setting] → [SRAM/Clock] and deselect the [Use SRAM Calendar] checkbox.

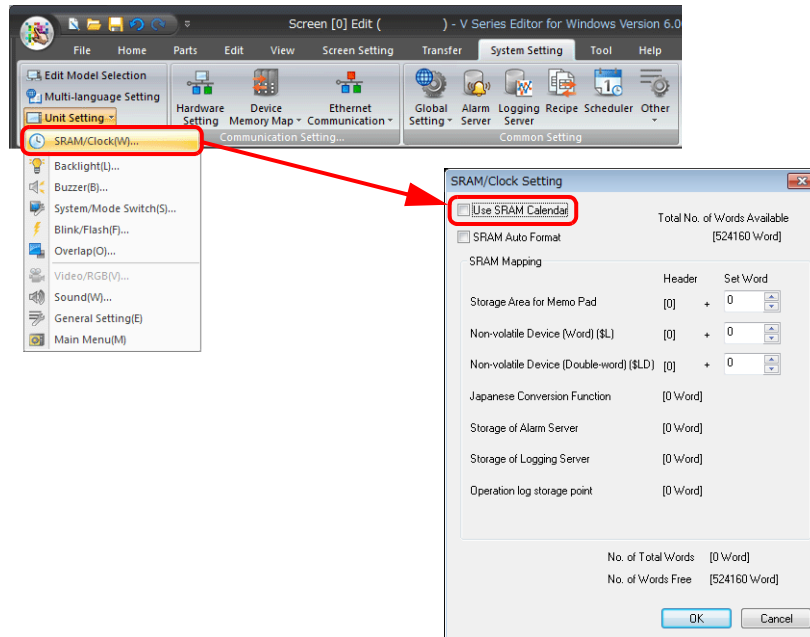

4. Click [Parts] → [Time Display] → [Time Display] and place a time display part.

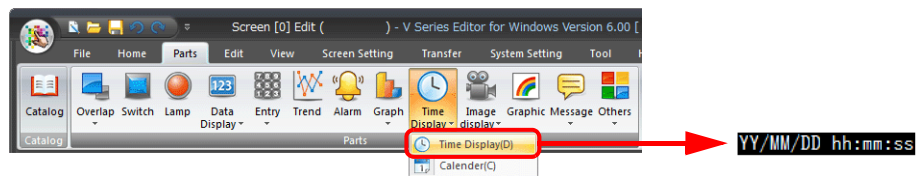

5. Double-click on the time display part to display the settings window. Configure the [Contents] settings as shown below.
- Select [Type] → [Display the system calendar].
  - Specify the format of the date and time under [Display Format].

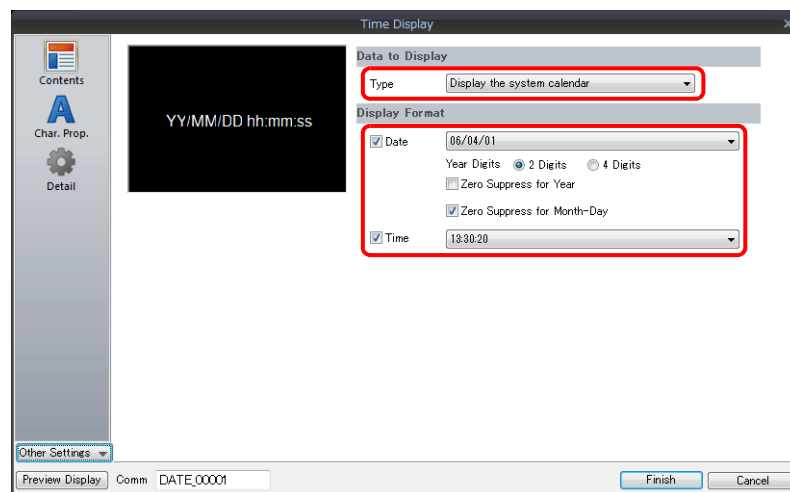

This completes the necessary settings.

## Displaying the Built-in V9 Series Calendar

The following example shows how to display the built-in V9 series calendar.

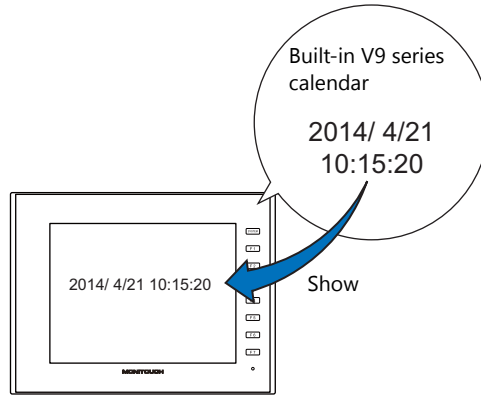

1. Click [System Setting] → [Unit Setting] → [SRAM/Clock] and select the [Use SRAM Calendar] checkbox.

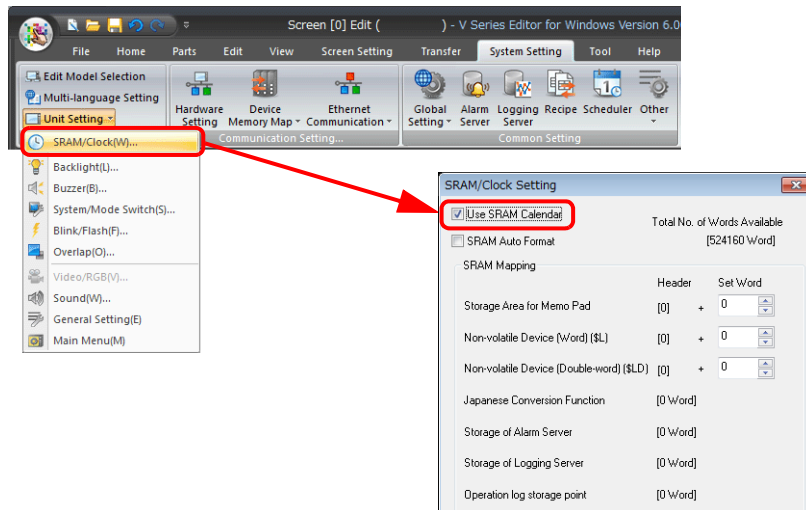

2. Click [Parts] → [Time Display] → [Time Display] and place a time display part.

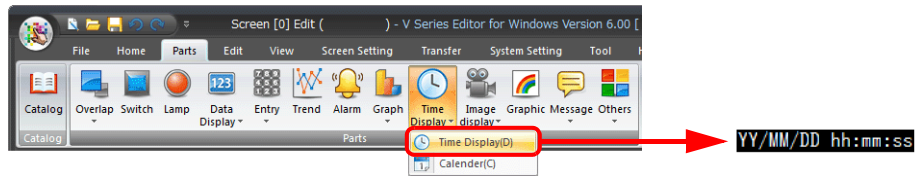

3. Double-click on the time display part to display the settings window.  
Configure the [Contents] settings as shown below.
  - Select [Type] → [Display the system calendar].
  - Specify the format of the date and time under [Display Format].

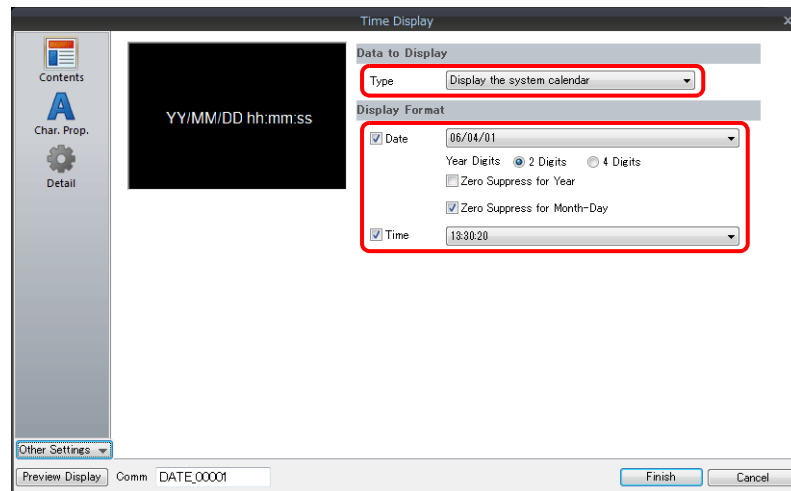

This completes the necessary settings.

## Display Using the Time Display Format Setting

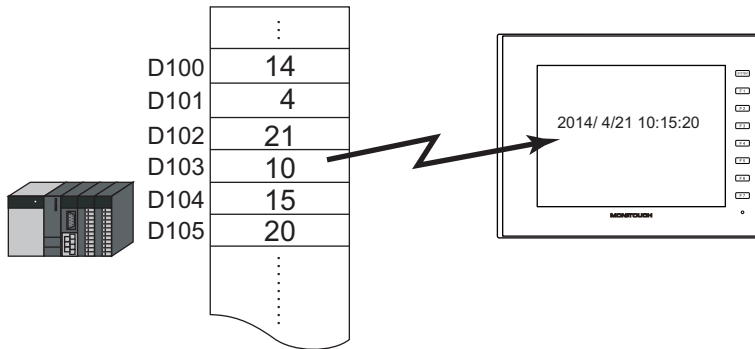

1. Click [Parts] → [Time Display] → [Time Display] and place a time display part.

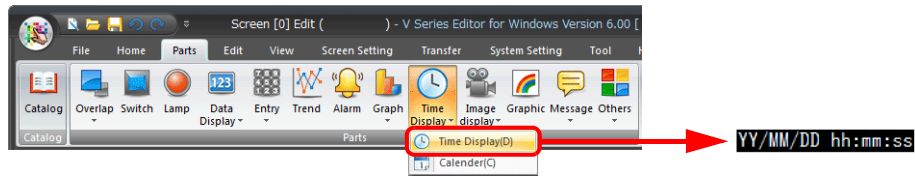

2. Double-click on the time display part to display the settings window. Configure the [Contents] settings as shown below.
  - Select [Type] → [Display the value of the designated device].
  - Select [Display Mode] → [Time Display].
  - Specify the top device memory address to use for time display with [Device Designation].
  - Specify the display format of the date and time under [Display Format].

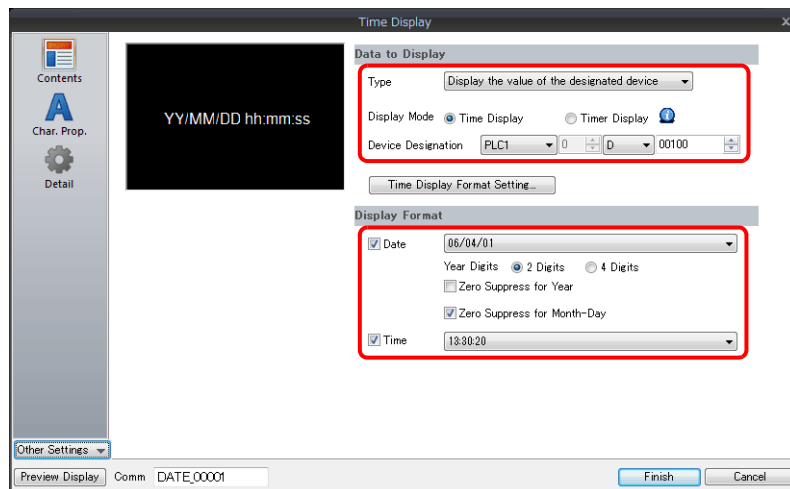

3. Specify the format of the data to read with [Time Display Format Setting].

Example 1: Read Word Count: 6  
 Data Unit: Word  
 Code Type: BCD  
 0000: Year  
 0001: Month  
 0002: Day  
 0003: Hour  
 0004: Minute  
 0005: Sec

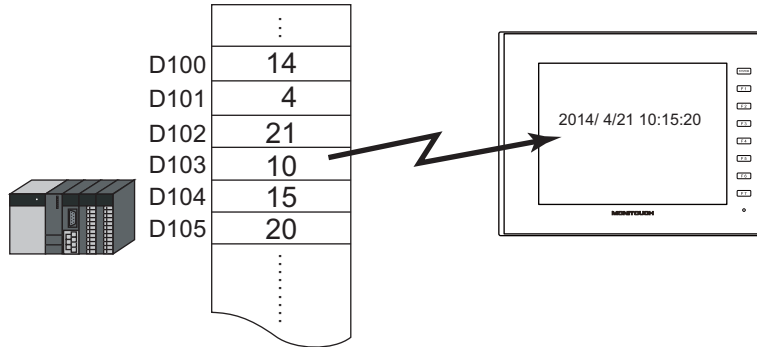
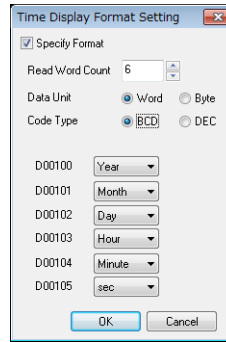

Example 2: Read Word Count: 3  
 Data Unit: Byte  
 Code Type: BCD  
 0000: Year Month  
 0001: Day Hour  
 0002: Minute Sec

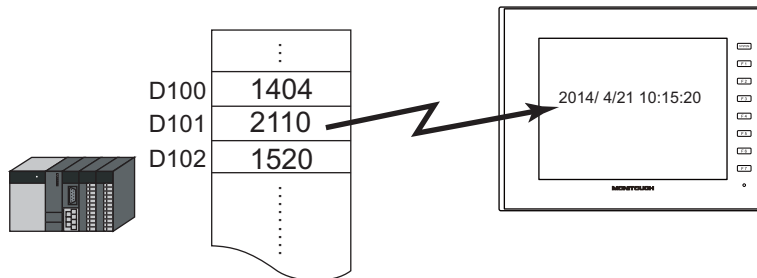
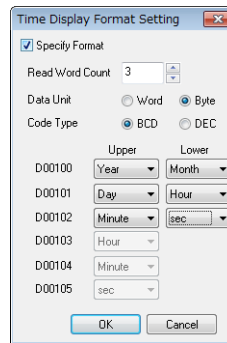

This completes the necessary settings.

## Displaying Seconds Data Stored in Device Memory in Timer Format

The following example shows how to display the seconds data stored in device memory in timer format on a V9 series unit.

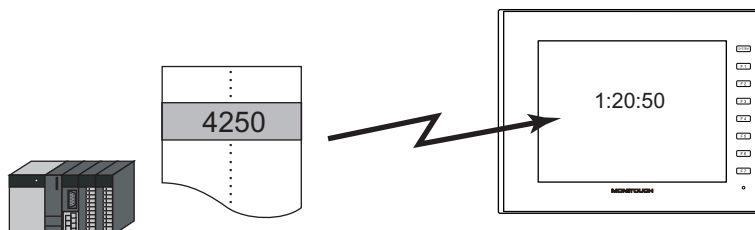

1. Click [Parts] → [Time Display] → [Time Display] and place a time display part.

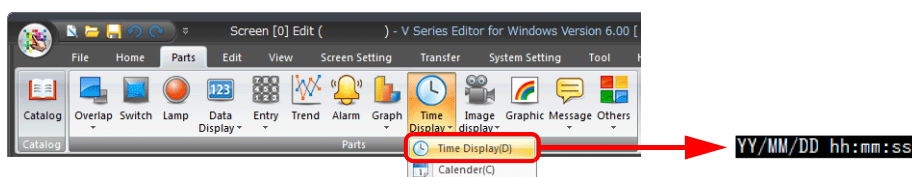

2. Double-click on the time display part to display the settings window.

Configure the [Contents] settings as shown below.

- Select [Type] → [Display the value of the designated device].
- Select [Display Mode] → [Timer Display].
- Specify the device memory address for storing the seconds data with [Device Designation].
- Specify the display format of the time under [Display Format].

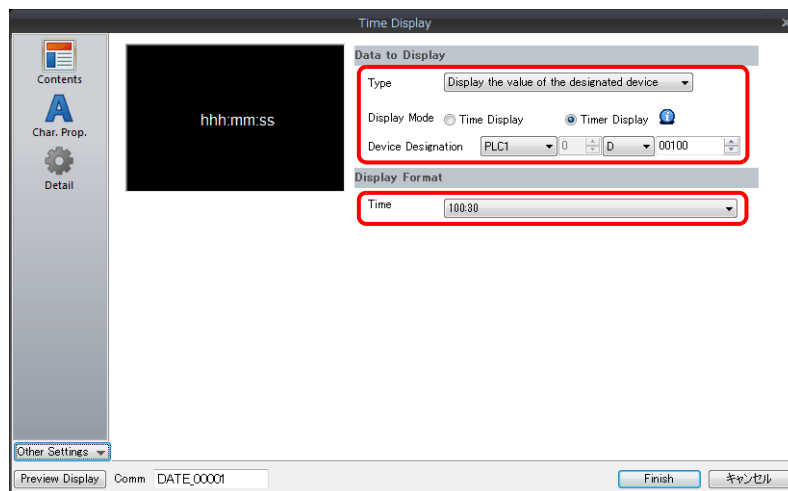

This completes the necessary settings.

## 10.2.3 Detailed Settings

### Contents

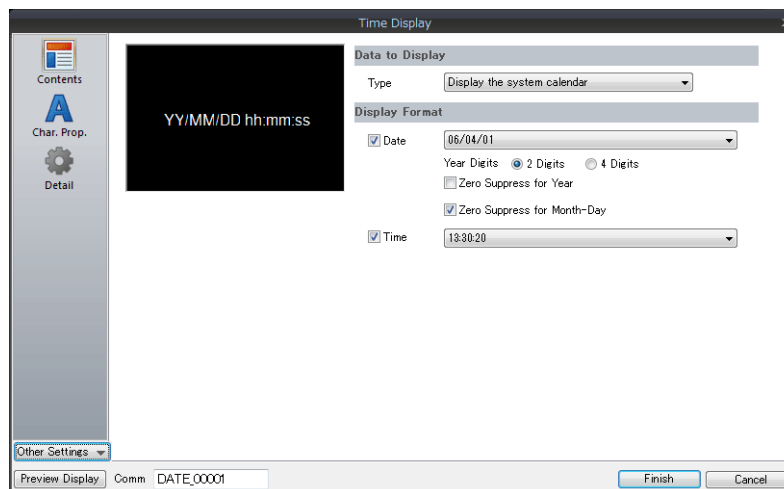

Item		Description	
Data to Display	Type	Display the system calendar	Use data from the PLC calendar, V9 series calendar, or calendar device memory. The display format can be set freely and the character size enlarged or reduced easily.
		Display the value of the designated device	Use a user-formatted calendar. Display the values of consecutive device memory addresses as the calendar.
	Display Mode	Time Display	This setting is available when "Display the value of the designated device" is selected for [Type]. Display the values of consecutive device memory addresses as the calendar.
		Timer Display	This setting is available when "Display the value of the designated device" is selected for [Type]. Display the seconds data stored in device memory in timer format.
	Device Designation	This setting is available when "Display the value of the designated device" is selected for [Type]. Specify the top address of the device memory for reading.	
	Time display format setting	This setting is available when "Display the value of the designated device" is selected for [Type]. Set the calendar data format. For details, refer to " <a href="#">Time display format setting</a> " page 10-12.	
Display Format	Date	Select this checkbox to display the date. Set the date display format.	
		Year Digits	Set the number of digits used to express the year.
		Zero Suppress for Year	Specify whether to use zero suppression for the year.
	Zero Suppress for Month-Day	Specify whether to use zero suppression for the month and day.	
	Time	Select this checkbox to display the time. Set the time display format.	

## Time display format setting

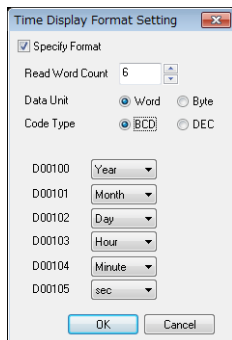

Item	Description
Specify Format	Select this checkbox if [Data Display] → [Type] → [Display the value of the designated device] is selected and [Display Mode] is set to [Time Display].
Read Word Count (1 - 6)	Data for the number of words to be read starting at [Device Designation] are read as the calendar data.
Data Unit *1 (Word, Byte)	Select [Word] or [Byte] for data unit when reading data from the PLC.
Code Type (BCD/DEC)	Select the code to be used at the time of reading data from the PLC.
0000 - 0005	Specify the contents of data for each device memory address.

\*1 Device memory allocation for each data unit

- Word

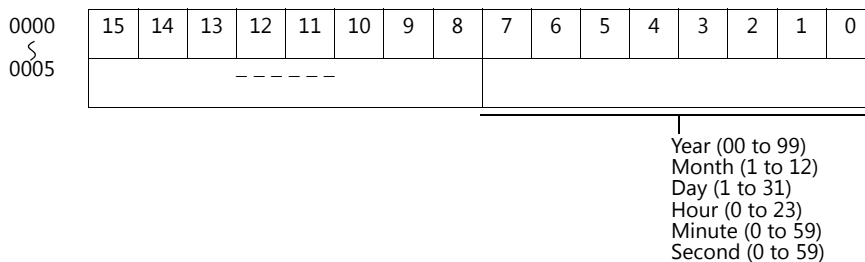

- Byte

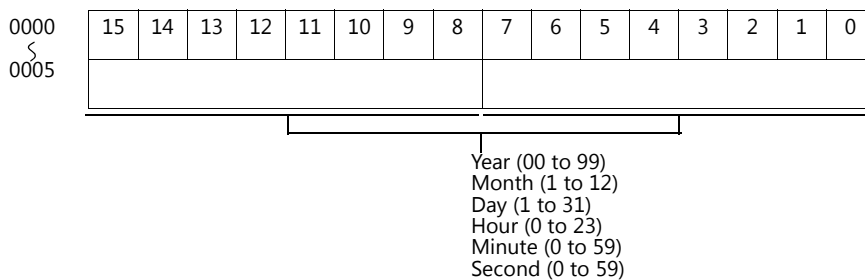



## Character Properties

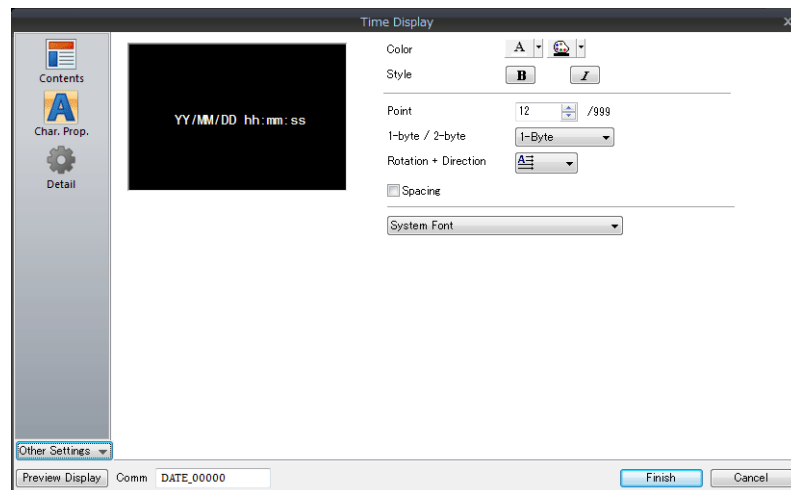

Item	Description
Color	Set the text color and area background color.
Style	Set the text style.
Character Size	Set the text size. This changes to point specification when using a Windows font or 7-segment font.
1-byte / 2-byte	Select one-byte or two-byte display.
Rotation + Direction	Set the orientation of text. This cannot be set when using a Windows font.
Spacing	To set a text spacing, select this checkbox and specify a spacing. This cannot be set when using a Windows font.
System Font Windows Font 7-segment Font	Select the font of the numerical data display.
Display light-out segments	This setting is available when [7-segment Font] is selected. Select this checkbox to display unlit segments.

## Detail

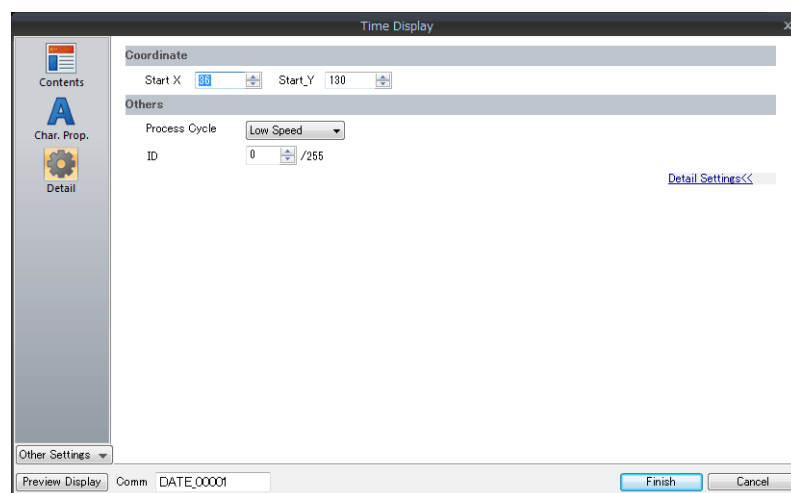

Item	Description	
Coordinates	Start X/Start Y	Specify the placement coordinates. (Coordinates at bottom left of part)
	Process Cycle	Set the process cycle.
Others	ID	Set the ID.

## 10.3 Calendar

### 10.3.1 Detailed Settings

#### Style

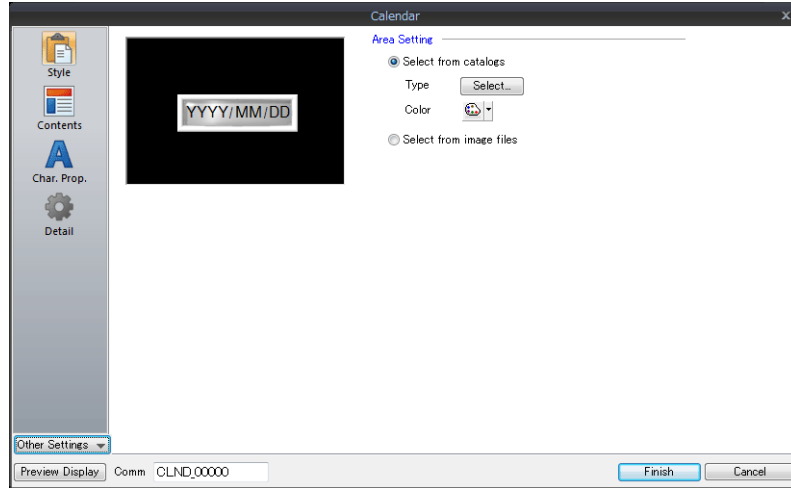

Item		Description
Area Setting	Select from catalogs	Type Set the part design. Color Set the part color.
	Select from image files	Load an image file.

#### Contents

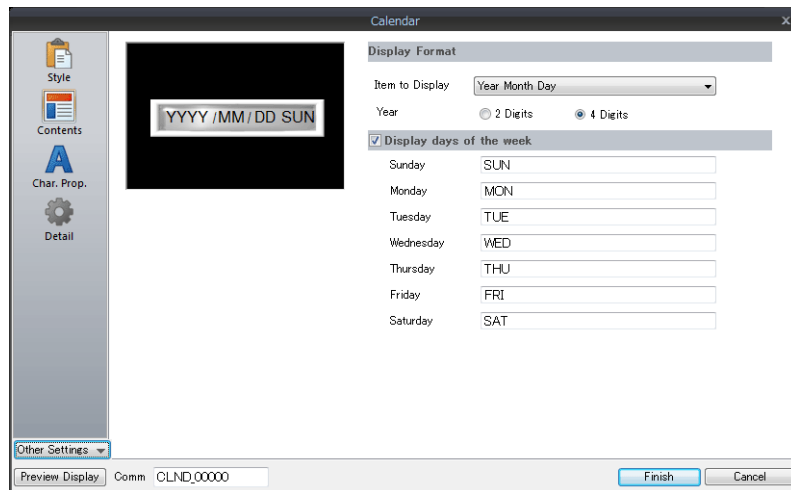

Item		Description
Display Format	Item to Display	Set the items to display on the calendar. The year in Western calendar format and the hour (0 to 24) are displayed. Year Month Day Hour Minute Second Year Month Day Hour Minute Second User format Select the checkbox of the items to display from year, month, day, hour, minute, and second.
	Year	Select either two digits or four digits to indicate the year. Display example: Two digits indicate the year 2014 as "14", and four digits as "2014".
Display days of the week		Register the display names of each day of the week. A maximum 13 one-byte characters (6 two-byte characters) can be used.

## Character Properties

### When [Batch edit date/time] is selected

The character properties of the year, month, day, hour, minute, and second can be set at once.

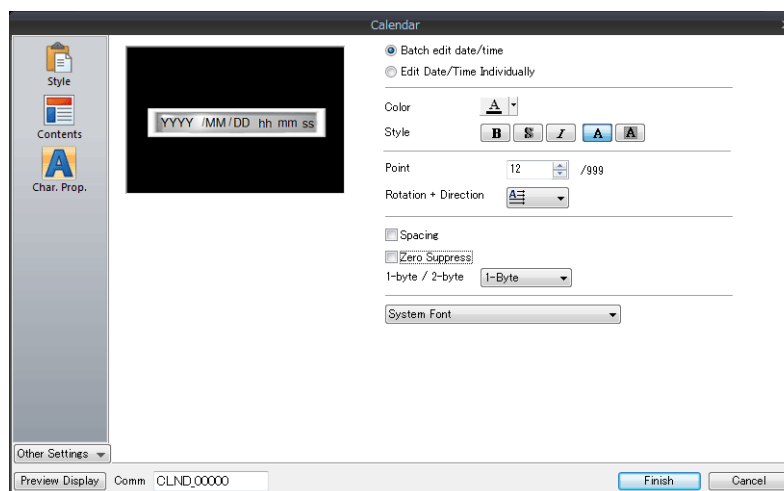

Item	Description
Color	Set the text color and area background color.
Style	Set the text style.
Character Size	Set the text size. This changes to point specification when using a Windows font or 7-segment font.
Rotation + Direction	Set the orientation of text. This cannot be set when using a Windows font.
Spacing	To set a text spacing, select this checkbox and specify a spacing. This cannot be set when using a Windows font.
Zero Suppress	Select this checkbox to use zero suppression.
1-byte / 2-byte	Select one-byte or two-byte display.
System Font Windows Font 7-segment Font	Select the font of the numerical data display.
Display light-out segments	This setting is available when [7-segment Font] is selected. Select this checkbox to display unlit segments.

## When [Edit Date/Time Individually] is selected

The character properties of the year, month, day, hour, minute, and second can be set individually.

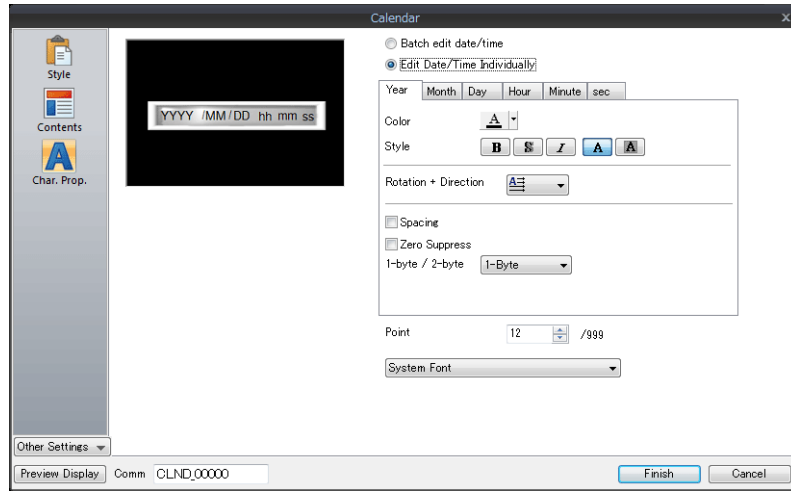

Item		Description
Year/Month/ Day/Hour/ Minute/sec	Color	Set the text color and area background color.
	Style	Set the text style.
	Rotation + Direction	Set the orientation of text. This cannot be set when using a Windows font.
	Spacing	To set a text spacing, select this checkbox and specify a spacing. This cannot be set when using a Windows font.
	Zero Suppress	Select this checkbox to use zero suppression.
	1-byte / 2-byte	Select one-byte or two-byte display.
Character Size	Set the text size. This changes to point specification when using a Windows font or 7-segment font.	
System Font Windows Font 7-segment Font	Select the font of the numerical data display.	
Display light-out segments	This setting is available when [7-segment Font] is selected. Select this checkbox to display unlit segments.	

## Detail

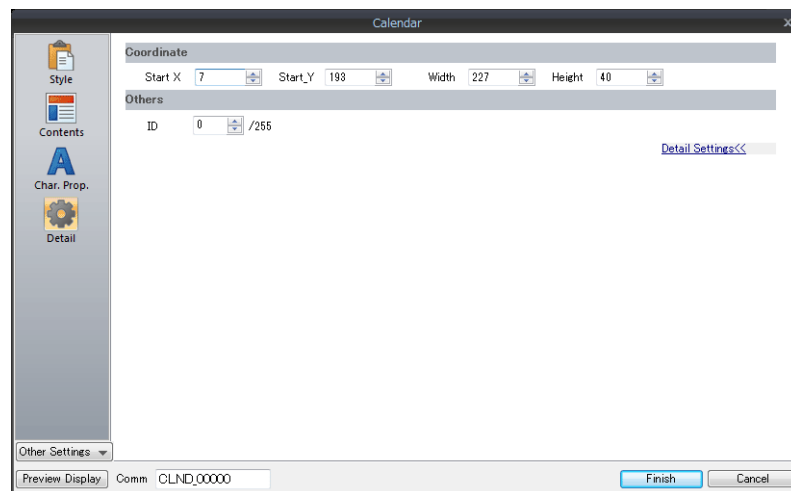

Item		Description
Coordinates	Start X/Start Y	Specify the placement coordinates. (Coordinates at top left of part)
	Width/Height	Specify the width and height of the part.
Others	ID	Set the ID.

## Notes

- Calendar parts consist of "hour, minute, and second" parts and "year, month, and day" parts as well as two-level displays. Additionally, there are parts for punctuation marks like ":" and "-".
- Calendar data is displayed in the following format on the computer.

<u>YY or YYYY</u>	<u>MM</u>	<u>DD</u>	<u>hh</u>	<u>mm</u>	<u>ss</u>	<u>SUN</u>
Year	Month	Day	Hour	Minute	Second	Weekday (Displayed as registered)

## 10.4 Calendar Data Correction

Calendar data that no longer displays the actual time can be corrected.

The setting method varies depending on the part selected.

Check the table of correction fields on "Overview" page 10-1 and correct the data as needed.

### 10.4.1 Correcting in the Control Area

#### PLC with Calendar Function

1. Refer to the PLC manual and correct time data in the calendar device memory of the PLC.
2. Set "0" to "1" for [Calendar Read Device] of [Control Area] set in [Hardware Setting].  
The V9 series will read the calendar data from the PLC.

#### PLC without Calendar Function

1. Set the correct calendar data for [Calendar Device] set at [Control Area] → [Other Settings].
2. Set "0" to "1" for [Calendar Read Device] of [Control Area].  
The set calendar data will be read.

#### (Operation Example)

[Calendar Device]: D100 to 106  
[Calendar Read Device]: D4-0

- (1) Set the data.  
D100 = 2014  
D101 = 4  
D102 = 20  
D103 = 12  
D104 = 30  
D105 = 0

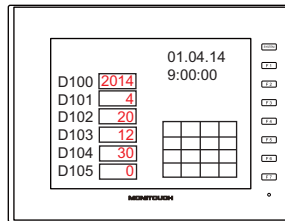

- (2) Set the D4-0 bit of the device memory set for calendar to ON.

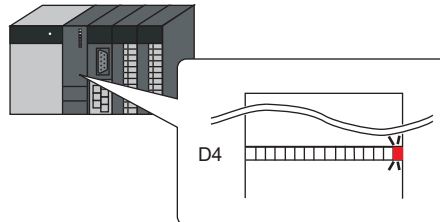

Calendar readout

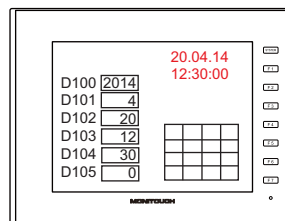

## 10.4.2 Correcting Using a Macro

The calendar data in PLC 1 can be corrected by executing the macro command "SYS (SET\_CLND)".

- According to the macro format, set data for "year, month, day, hour, minute, and second" correctly at the relevant device memory.
- Execute the "SYS(SET\_CLND)" macro command as the ON macro of a switch, etc.  
The calendar data is written to PLC1.  
The corrected calendar data will be read.

### (Operation Example)

- Set the data.  
Set 20.04.14, 12:00:00.  
\$u0000 = 2014 (W)  
\$u0001 = 4 (W)  
\$u0002 = 20 (W)  
\$u0003 = 12 (W)  
\$u0004 = 0 (W)  
\$u0005 = 0 (W)

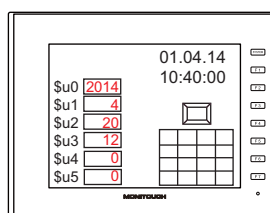
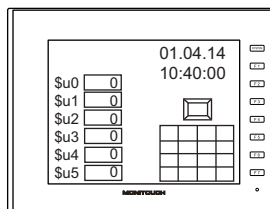

- Execute the macro command.  
Set the calendar of PLC1, port 1 to 20.04.14 12:00:00.

[ON Macro Edit]  
SYS(SET\_CLND) \$u0000

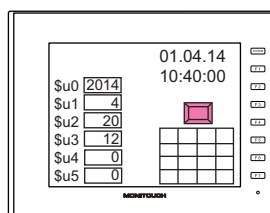

Rewrite the PLC calendar.

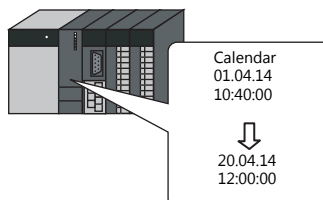

Calendar readout

Macro commands "PLC\_CLND" and "SYS(SET\_SYS\_CLND)" are used to correct the calendar data in PLC2 to PLC8. For details, refer to the V9 Series Macro Reference Manual.

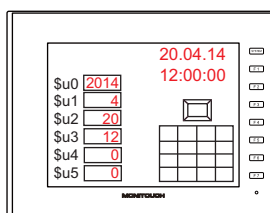

## 10.4.3 Correcting in Local Mode

Calendar data can be set on the [SRAM/Clock] screen that can be displayed in Local mode.

- \* **Correction can only be performed when using the built-in clock.**

 For details on settings, refer to the V9 Series Troubleshooting/Maintenance Manual.

# MEMO

MONITOUCH

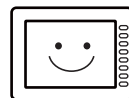



# **11 Graphics and Animation**

---

11.1 Graphics

11.2 Animation

## 11.1 Graphics

### 11.1.1 Overview

A variety of pre-registered graphics can be displayed on the screen or changed based on bit activation and the graphic number.

The graphic display method differs depending on the [Operation Select] setting.

- Switch

Switches can be used to display or change between graphics and text registered in the graphic library. In this case, the displayed graphics cannot be moved or transformed.

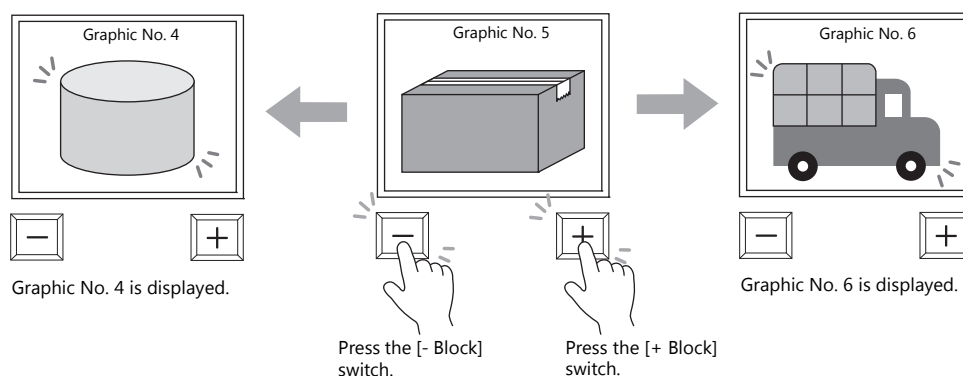

- Device (No. Designation)

A graphic number can be specified for display using the [Device (No. Designation)] setting.

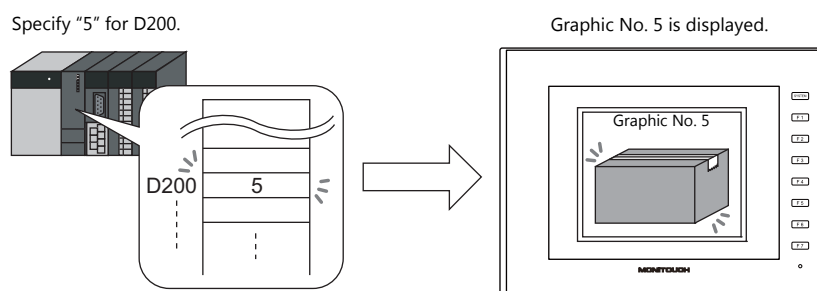

The displayed graphics can be moved or transformed.

To animate or transform graphics or text, set up parameters for these items in the graphic library.

When parameters are set, the required device memory addresses are allocated for animation and transformation.

For details on the procedure for setting parameters, refer to "11.1.4 Graphic Library (Parameter Settings)" page 11-14.

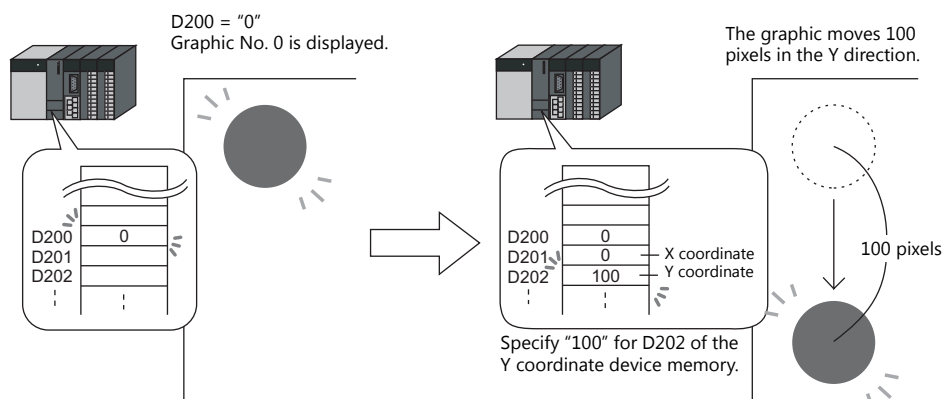

- Device (Bit Designation)

The graphics or text registered in the graphic library can be shown or hidden according to bit activation. There are two display types.

- Type: 1-Graphic

When the bit is set to ON, the corresponding graphic is shown, and when the bit is set to OFF, the graphic is hidden.

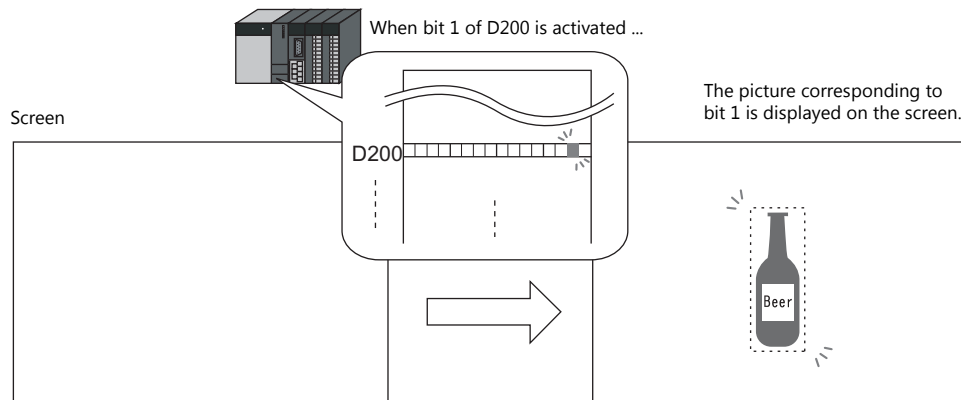

- Type: 2-Graphic

Two graphics are assigned to one bit. When the bit is set to OFF, the OFF graphic is displayed, and when the bit is set to ON, the ON graphic is displayed.

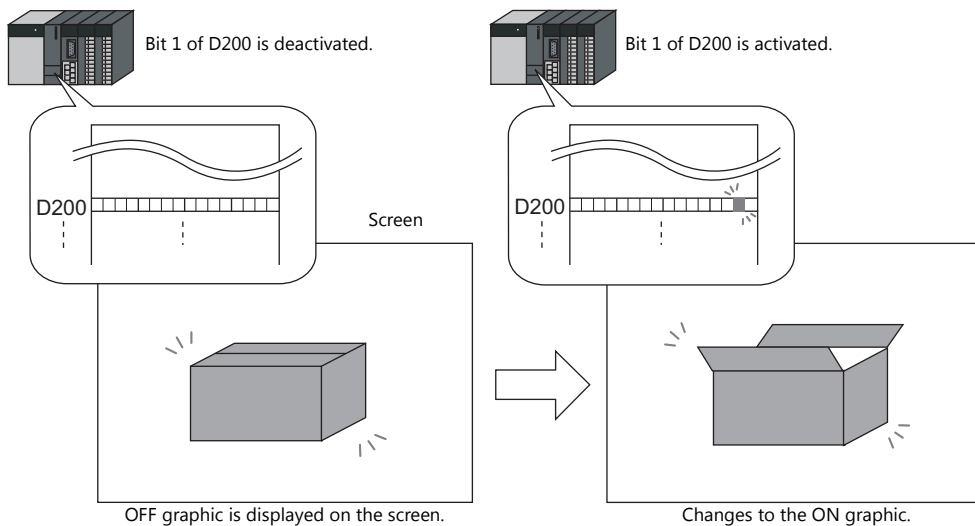

- It is possible to move or transform the graphics or text set for [1-Graphic] and [2-Graphic].

To animate or transform graphics or text, set up parameters for these items in the graphic library.

When parameters are set, the required device memory addresses are allocated for animation and transformation.

For details on the procedure for setting parameters, refer to "11.1.4 Graphic Library (Parameter Settings)" page 11-14.

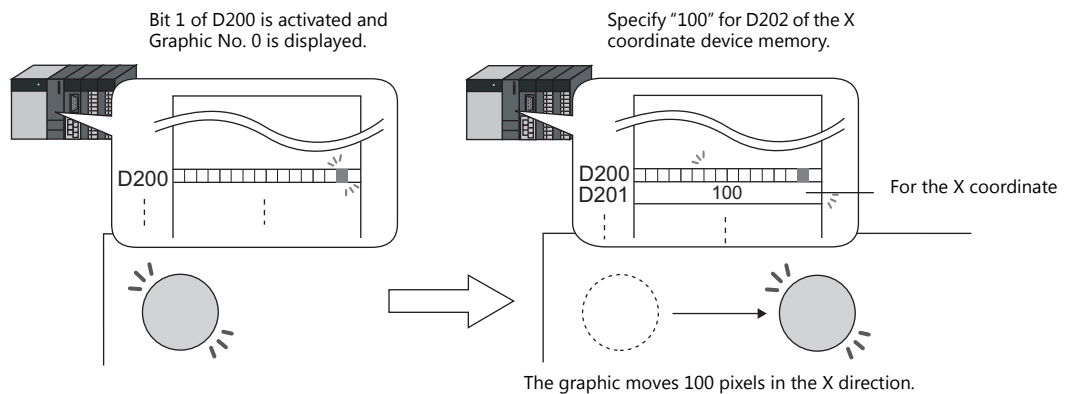

\* The graphic mode display is possible without placing a display area part. For details, refer to page 11-7.

## 11.1.2 Detailed Settings

### Operation Select: Switch

#### Graphic Select

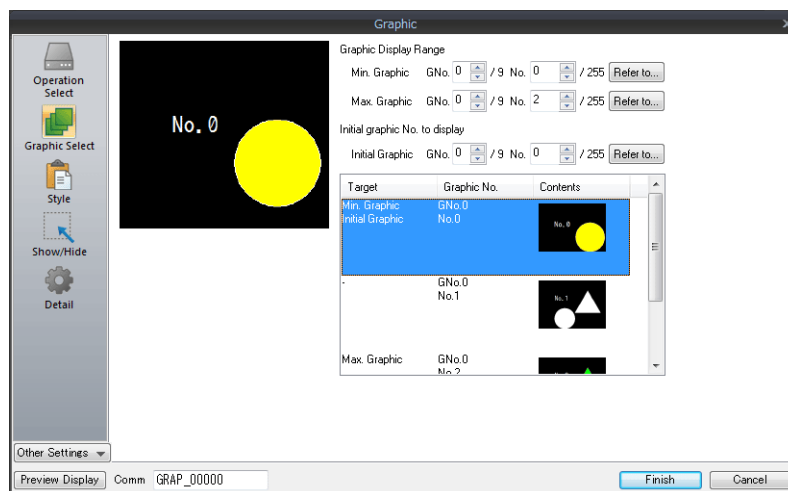

Item	Description
Min. Graphic	Set the graphic with the lowest number among those to be displayed on the screen.
Max. Graphic	Set the graphic with the highest number among those to be displayed on the screen.
Initial Graphic	Set the initial graphic to show when the screen is displayed. Select an initial graphic number between the minimum and maximum graphic numbers.

#### Style

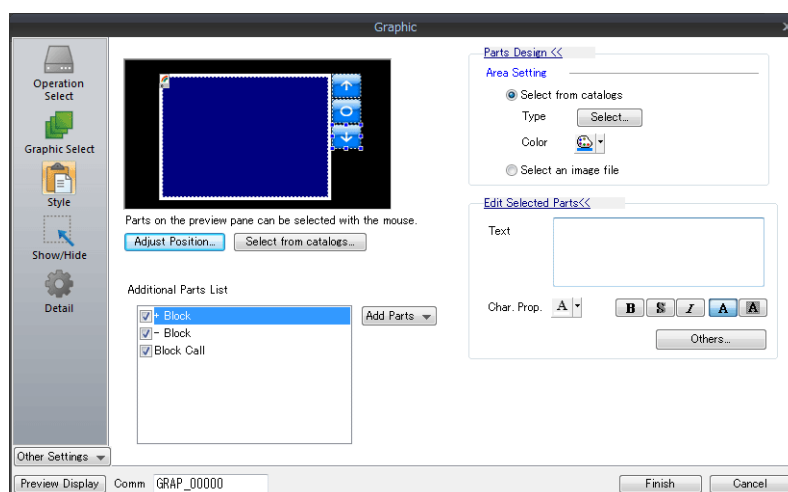

Item	Description
Additional Parts List	Select an operation switch. Parts can be added to the list using the [Add Parts] button.
+ Block	Switches to the next graphic.
- Block	Switches to the previous graphic.
Block Call	Switches to the specified graphic number. The graphic number is specified via [Edit Selected Parts] → [Others].
Parts Design	Set the design and color of parts.
Edit Selected Parts	Configure the part selected in the [Additional Parts List] or preview pane. Part size can also be changed.
Adjust Position	Displays the window for adjusting the placement position of each part.
Select from catalogs	Set the part design from the catalog.

## Display area

The size of the display area must be changed to accommodate the graphic for display. The position of the "OFF" mark (offset mark) of the graphic library corresponds to the upper left corner of the display area part on the screen. Take this position into consideration when determining the size of the display area part.

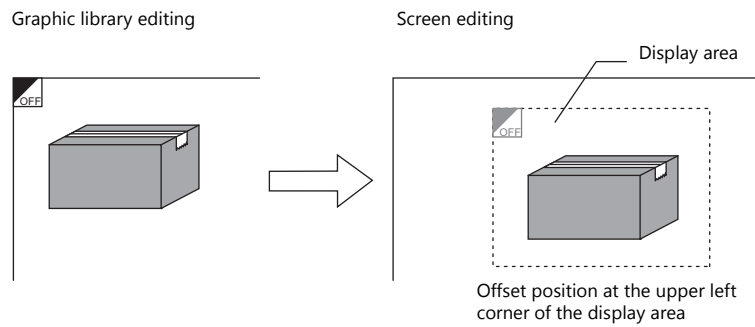

## Show/Hide

Set the show and hide settings of graphic items.

 For details, refer to "14 Item Show/Hide Function".

## Detail

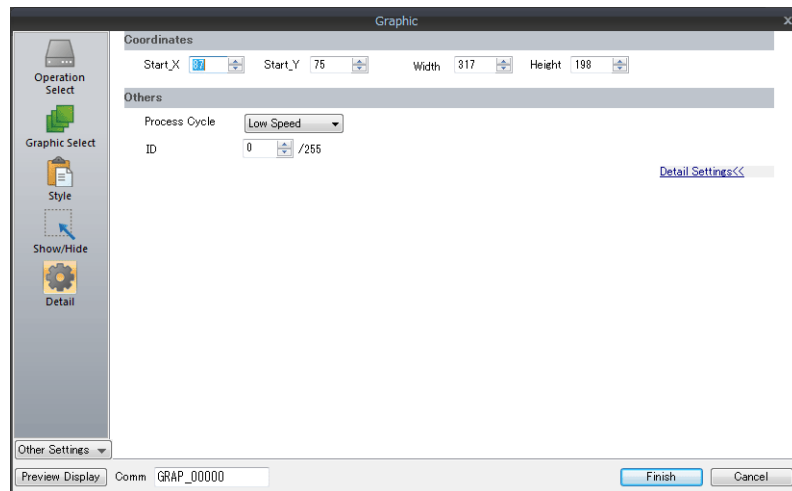

Item	Description	
Coordinates	Start X/Start Y	Specify the coordinates of the display area.
	Width/Height	Set the size of the display area.
Others	Process Cycle	Set the cycle for the V9 series to read PLC data.
	ID	Set an ID number.

## Operation Select: Device (No. Designation)

### Graphic Select

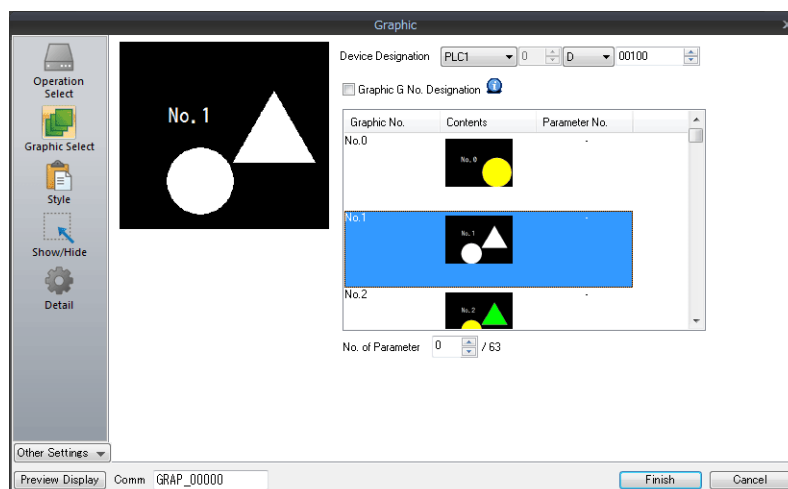

Item	Description																																							
Device Designation	<p>Specify the device memory addresses used for specifying a graphic number. Consecutive device memory addresses are used when a parameter is specified. <sup>*1</sup></p> <table border="1"> <thead> <tr> <th>Device Memory</th> <th>Description</th> <th>Remarks</th> </tr> </thead> <tbody> <tr> <td>n</td> <td>Graphic No.</td> <td></td> </tr> <tr> <td>n+1</td> <td>Parameter 1</td> <td rowspan="4">Only with parameter specification.</td> </tr> <tr> <td>n+2</td> <td>Parameter 2</td> </tr> <tr> <td>:</td> <td>:</td> </tr> <tr> <td>n+63</td> <td>Parameter 63</td> </tr> </tbody> </table>	Device Memory	Description	Remarks	n	Graphic No.		n+1	Parameter 1	Only with parameter specification.	n+2	Parameter 2	:	:	n+63	Parameter 63																								
Device Memory	Description	Remarks																																						
n	Graphic No.																																							
n+1	Parameter 1	Only with parameter specification.																																						
n+2	Parameter 2																																							
:	:																																							
n+63	Parameter 63																																							
Graphic G No. Designation	<p><b>Selected</b> Specify 0 to 9 for the graphic group number. The graphics that can be displayed on the screen are limited to those (0 to 255) of the specified group number.</p> <p><b>Unselected</b> All graphics corresponding to graphic group numbers 0 to 9 can be displayed. Specify the graphic numbers using absolute addresses (0 to 2559).</p> <table border="1"> <thead> <tr> <th colspan="2">With Group No. Specification</th> <th colspan="2">Without Group No. Specification (Absolute Address)</th> </tr> <tr> <th>Group No.</th> <th>Graphic No.</th> <th>Group No.</th> <th>Graphic No.</th> </tr> </thead> <tbody> <tr> <td>0</td> <td>0000 - 0255</td> <td rowspan="10">(None)</td> <td>0000 - 0255</td> </tr> <tr> <td>1</td> <td>0000 - 0255</td> <td>0256 - 0511</td> </tr> <tr> <td>2</td> <td>0000 - 0255</td> <td>0512 - 0767</td> </tr> <tr> <td>3</td> <td>0000 - 0255</td> <td>0768 - 1023</td> </tr> <tr> <td>4</td> <td>0000 - 0255</td> <td>1024 - 1279</td> </tr> <tr> <td>5</td> <td>0000 - 0255</td> <td>1280 - 1535</td> </tr> <tr> <td>6</td> <td>0000 - 0255</td> <td>1536 - 1791</td> </tr> <tr> <td>7</td> <td>0000 - 0255</td> <td>1792 - 2047</td> </tr> <tr> <td>8</td> <td>0000 - 0255</td> <td>2048 - 2303</td> </tr> <tr> <td>9</td> <td>0000 - 0255</td> <td>2304 - 2559</td> </tr> </tbody> </table>	With Group No. Specification		Without Group No. Specification (Absolute Address)		Group No.	Graphic No.	Group No.	Graphic No.	0	0000 - 0255	(None)	0000 - 0255	1	0000 - 0255	0256 - 0511	2	0000 - 0255	0512 - 0767	3	0000 - 0255	0768 - 1023	4	0000 - 0255	1024 - 1279	5	0000 - 0255	1280 - 1535	6	0000 - 0255	1536 - 1791	7	0000 - 0255	1792 - 2047	8	0000 - 0255	2048 - 2303	9	0000 - 0255	2304 - 2559
With Group No. Specification		Without Group No. Specification (Absolute Address)																																						
Group No.	Graphic No.	Group No.	Graphic No.																																					
0	0000 - 0255	(None)	0000 - 0255																																					
1	0000 - 0255		0256 - 0511																																					
2	0000 - 0255		0512 - 0767																																					
3	0000 - 0255		0768 - 1023																																					
4	0000 - 0255		1024 - 1279																																					
5	0000 - 0255		1280 - 1535																																					
6	0000 - 0255		1536 - 1791																																					
7	0000 - 0255		1792 - 2047																																					
8	0000 - 0255		2048 - 2303																																					
9	0000 - 0255		2304 - 2559																																					
No. of Parameter <sup>*1</sup>	<p>This is required when moving or changing graphics. Set the maximum parameter value of items registered in the graphic library. The valid parameter number determines the number of words secured for the specified device memory address. For details on parameter settings, refer to "11.1.4 Graphic Library (Parameter Settings)" page 11-14.</p>																																							

\*1 Example of using parameters

The table below shows device memory assignment and contents when the following settings are configured.

Graphics

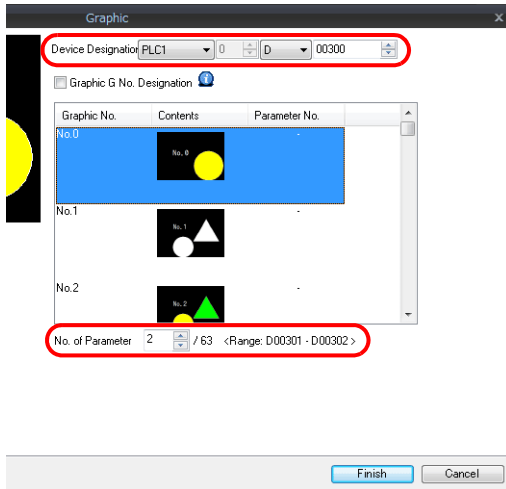

Graphics library

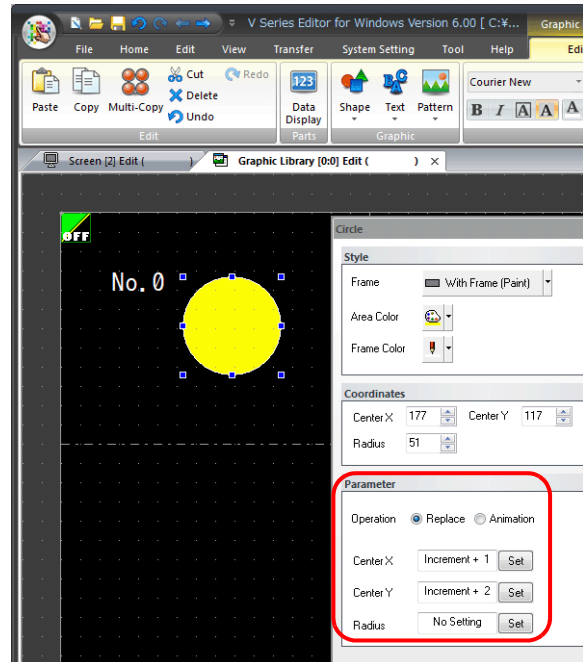

Device Memory	Description		Remarks
D300	Device	Device memory for graphic number specification	
D301	Parameter 1	Device memory for Center X coordinate specification	[Valid parameter No.] is set to "2" so two words are secured for use.
D302	Parameter 2	Device memory for Center Y coordinate specification	

Style

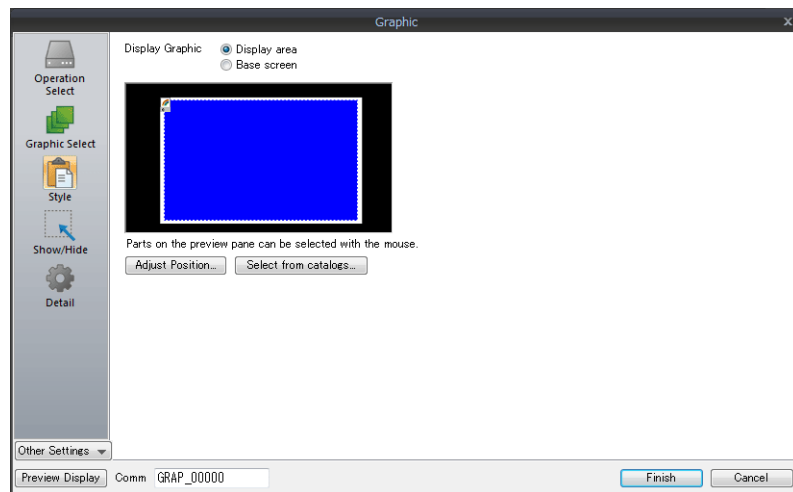

Item	Description
Display Graphic	Select the area for displaying graphics. Display area/Base screen
Adjust Position	Displays the window for adjusting the placement position of each part. Part size can also be changed.
Select from catalogs	Set the part design from the catalog.

## Display area

- When [Display Graphic] is set to [Display area]  
The offset position of the graphic library corresponds to the upper left corner of the display area part. Take this position into consideration when determining the size of the display area part. Refer to [page 11-4](#).

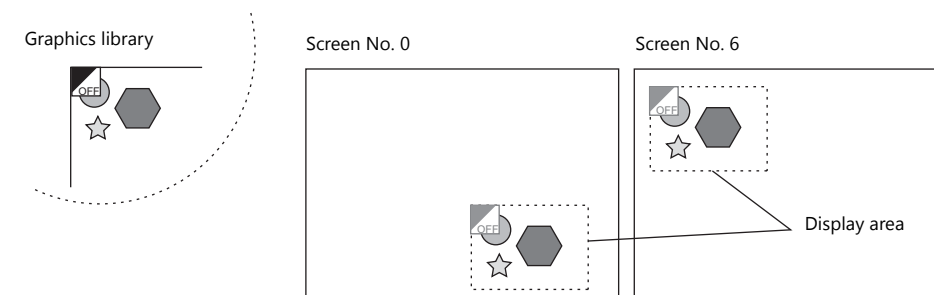

- When [Display Graphic] is set to [Base screen]  
The offset position of the graphic library corresponds to the upper left corner of the screen.

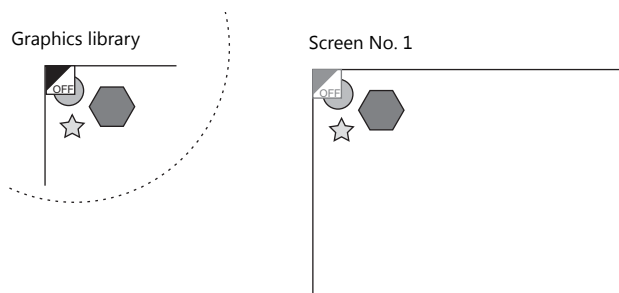

- If [Base area] for [Display Graphic] is selected and there is no display area, the previous picture may remain on the screen when the picture is changed.

## Show/Hide

Set the show and hide settings of graphic items.

 For details, refer to "14 Item Show/Hide Function".

## Detail

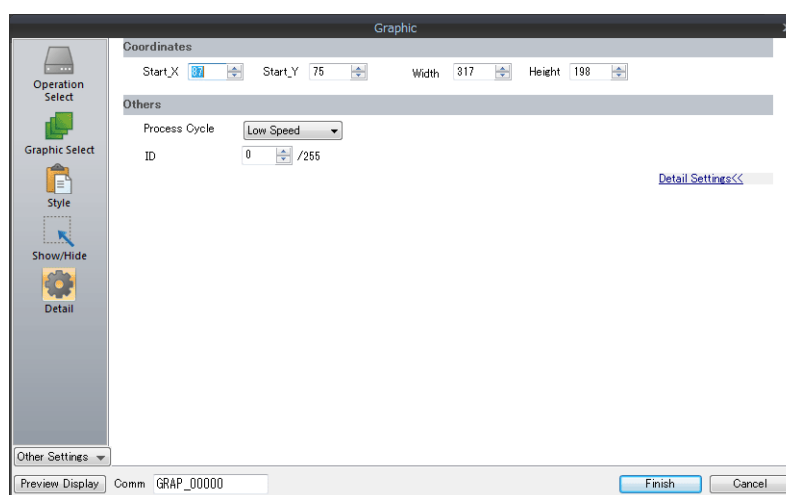

Item	Description	
Coordinates	Start X/Start Y	Specify the coordinates of the display area.
	Width/Height	Set the size of the display area.
Others	Process Cycle	Set the cycle for the V9 series to read PLC data.
	ID	Set an ID number.



# Operation Select: Device (Bit Designation)

## Graphic Select

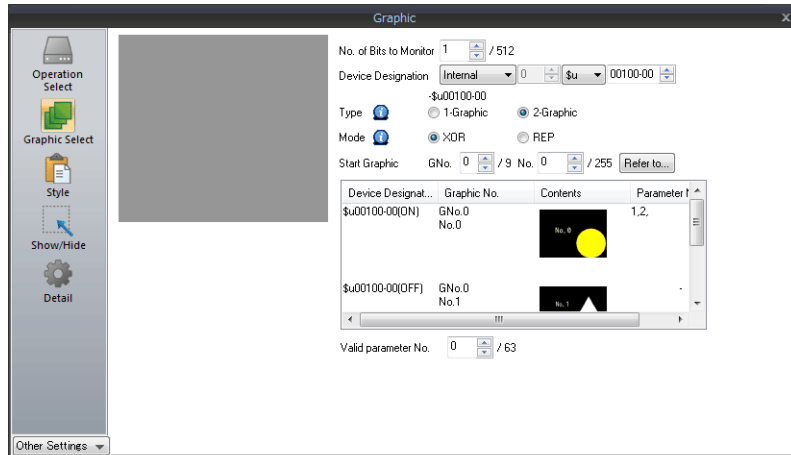

Item	Description
No. of Bits to Monitor <sup>*1</sup>	Set the total number of bits used for displaying graphics. 1 - 512
Device Designation <sup>*1</sup>	Set the device memory used for displaying graphics. Consecutive bits are used for the number of monitored bits.
Type <sup>*1</sup>	Select the graphic display method.
1-Graphic	A graphic is displayed when the bit is set to ON. OFF: Graphic hidden ON: Graphic shown
2-Graphic	A graphic is displayed when the bit is set to either ON or OFF. OFF: OFF graphic shown ON: ON graphic shown
Mode <sup>*3</sup>	Specify the display state when changing between graphics. This setting is available when [Type] is set to [2-Graphic]. When [Type] is set to [1-Graphic], the mode is fixed to [XOR].
XOR	Bit OFF: OFF graphic is displayed. Bit OFF → ON: OFF graphic is cleared and ON graphic is displayed. Bit ON → OFF: ON graphic is cleared and OFF graphic is displayed.
REP	Bit OFF: OFF graphic is displayed. Bit OFF → ON: ON graphic is displayed over the OFF graphic. Bit ON → OFF: OFF graphic is displayed over the ON graphic. The graphics are not XORed with the base screen and are instead displayed in their original colors.
Start Graphic <sup>*1</sup>	Set the starting graphic group number and graphic number of the graphic to display.
Valid parameter No. <sup>*2</sup>	This is required when moving or transforming the graphics. Specify the total number of parameters set for each graphic. The number of words for the device memory and allocation is determined from this total and the parameter numbers. (For details on the parameter setting, refer to the V9 Series Operation Manual.)

<sup>\*1</sup> Display example:  
 [Device Designation]: D200, [Start Graphic]: GNo. 0, No. 0, [No. of Bits to Monitor]: 12  
 - Type: 1-Graphic

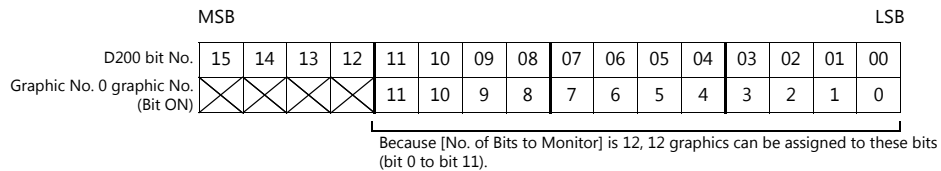

- Type: 2-Graphic

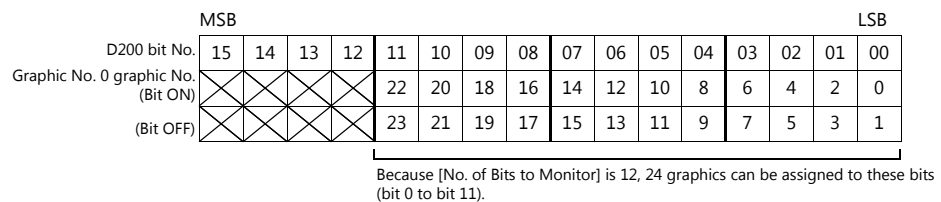

\*2 Display example:  
 [Device Designation]: D200, [Type]: 1-Graphic, [Start Graphic]: GNo. 1, No. 4, [No. of Bits to Monitor]: 20, [Valid parameter No.]: 4

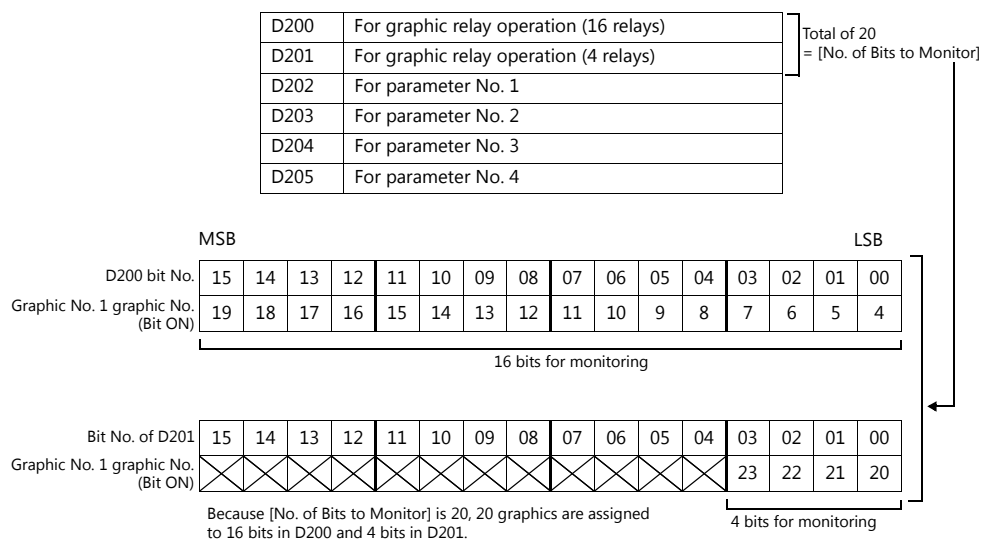

\*3 Display example:

- Mode: XOR

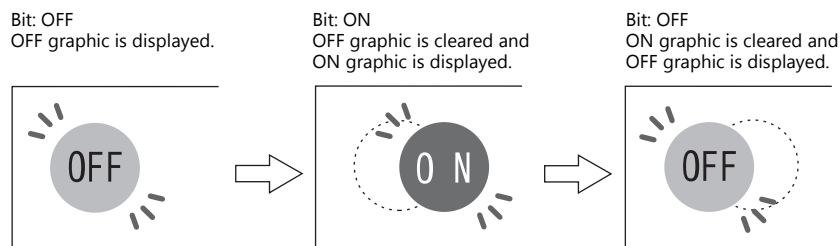

In XOR mode, the graphic color is XORed with the colors of the base screen (display area). Therefore, the graphic is displayed in the color XORed with the base color (= XORed color), rather than the color specified during editing. For details on XORed color, refer to [page 11-12](#).

Graphic library editing

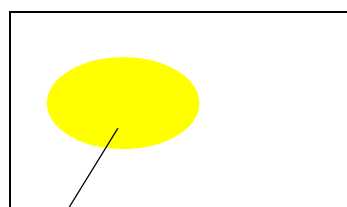

Ellipse in solid color  
Foreground color: yellow

When displayed on the screen (background: blue):

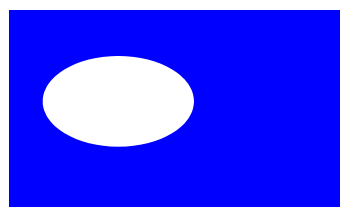

Yellow ellipse is XORed into white by blue screen.

- Mode: REP

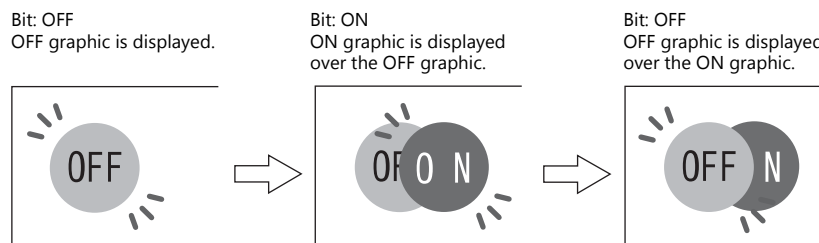

## Style

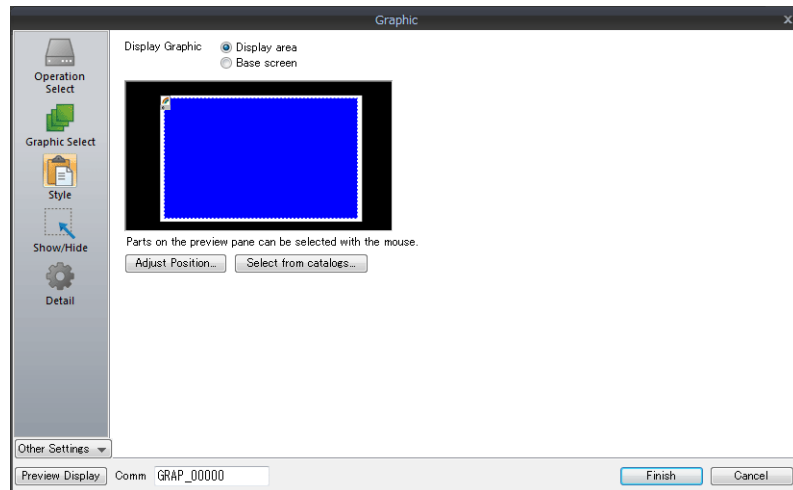

Item	Description
Display Graphic	Select the area for displaying graphics. Display area/Base screen
Adjust Position	Displays the window for adjusting the placement position of each part. Part size can also be changed.
Select from catalogs	Set the part design from the catalog.

### Display area

- Offset

- When [Display Graphic] is set to [Display area]

The offset position of the graphic library corresponds to the upper left corner of the display area part. Take this position into consideration when determining the size of the display area part.

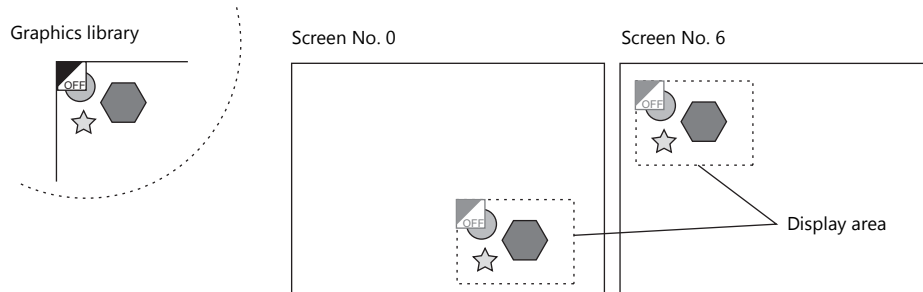

- When [Display Graphic] is set to [Base screen]

The offset position of the graphic library corresponds to the upper left corner of the screen.

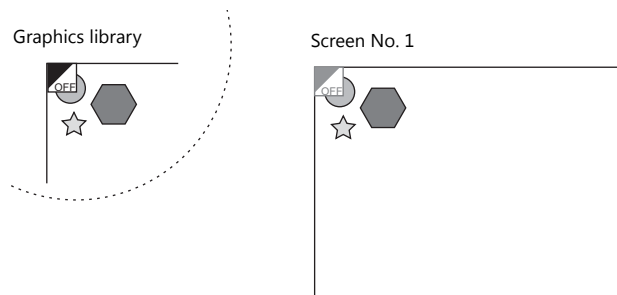

- Transparency  
Select the [Transparent] checkbox for the display area part to add transparency to the display area part properties. Select this checkbox to avoid a situation where graphics under the display area part are hidden. For details on part changes, refer to the V9 Series Operation Manual.

- Example with transparent setting

- Not transparent

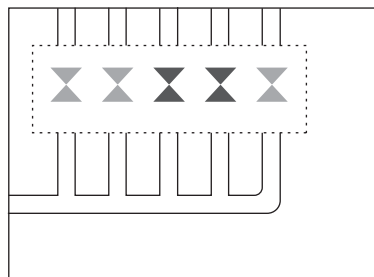

- Transparent

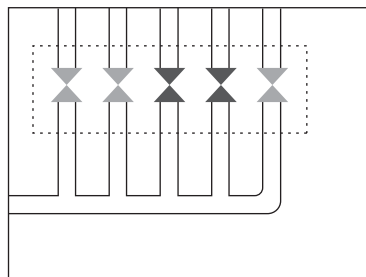

## Show/Hide

Set the show and hide settings of graphic items.

 For details, refer to "14 Item Show/Hide Function".

## Detail

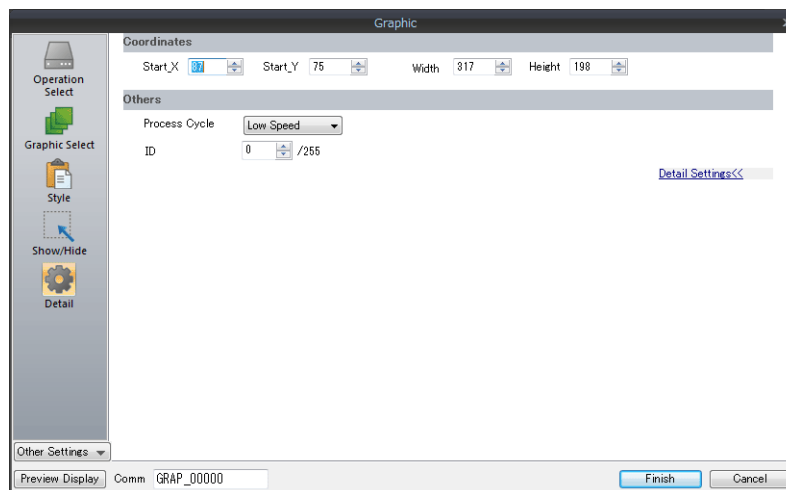

Item	Description	
Coordinates	Start X/Start Y	Specify the coordinates of the display area.
	Width, Height	Set the size of the display area.
Others	Process Cycle	Set the cycle for the V9 series to read PLC data.
	ID	Set an ID number.

## 11.1.3 Graphic Display Color

### Display Modes

When graphics are displayed on the screen, there are two types of display modes.

- XOR: Graphic colors are XORed with the colors of the base screen.
- REP: Original graphic colors are shown.

Whether XOR or REP is used for the display state is determined by the mode and parameter settings. Refer to the following table.

Graphic Switching Method		Type	Graphic Registration	Parameter	
				Action: Replace	Action: Animation
Switch				REP	XOR
Device (No. Designation)				REP	XOR
Device (Bit Designation)	1-Graphic			XOR	XOR
	2-Graphic		Mode: XOR	XOR	XOR
			Mode: REP		REP

\* When the graphic to be displayed is a "Paint" graphic, it cannot be displayed in XORed colors.

\* When a pattern with a [Transparent Color Setting] is used, the graphic can be displayed with the original colors even if [Mode] is set to [XOR]. For details, refer to [page 11-13](#).

### XORed Colors

When [XOR] is selected, graphic colors are XORed with the colors of the base screen (display area). The resulting color is called "XORed color." The basic eight XORed colors are shown below.

Overlaid picture colors (basic eight colors)

		Black	Blue	Red	Magenta	Green	Cyan	Yellow	White
Base screen picture colors (basic eight colors)	Black	Black	Blue	Red	Magenta	Green	Cyan	Yellow	White
	Blue	Blue	Black	Magenta	Red	Cyan	Green	White	Yellow
	Red	Red	Magenta	Black	Blue	Yellow	White	Green	Cyan
	Magenta	Magenta	Red	Blue	Black	White	Yellow	Cyan	Green
	Green	Green	Cyan	Yellow	White	Black	Blue	Red	Magenta
	Cyan	Cyan	Green	White	Yellow	Blue	Black	Magenta	Red
	Yellow	Yellow	White	Green	Cyan	Red	Magenta	Black	Blue
	White	White	Yellow	Cyan	Green	Magenta	Red	Blue	Black

### XOR operations

Each of the basic eight colors has an identification code as given below:

64k-color		32k-color	
Color	Code HEX	Color	Code HEX
Black	0000	Black	0000
Blue	001F	Blue	001F
Red	F800	Red	7C00
Magenta	F81F	Magenta	7C1F
Green	07E0	Green	03E0
Cyan	07FF	Cyan	03FF
Yellow	FFE0	Yellow	7FE0
White	FFFF	White	7FFF

When a color is XORed with another color, it means that the two color codes are XORed to obtain another code.

	64k-color	XORed color of blue and white	32k-color	XORed color of blue and white
Blue	0000	0000 0001 1111 (001F)	0000	0000 0001 1111 (001F)
White	1111	1111 1111 1111 (FFFF)	0111	0111 1111 1111 (7FFF)
		XOR ↓		XOR ↓
Yellow	1111	1111 1111 1110 0000 (FFE0)	0111	0111 1111 1110 0000 (7FE0)

## XOR Display Transparency (Pattern Transparency)

Because animation on a graphic display is always XORed, it is impossible to display the same colors on the screen as initially set for the background color (other than black).

Additionally, because the XORed color is affected by the base color, when animation is performed on multiple background colors, the color changes whenever the background does.

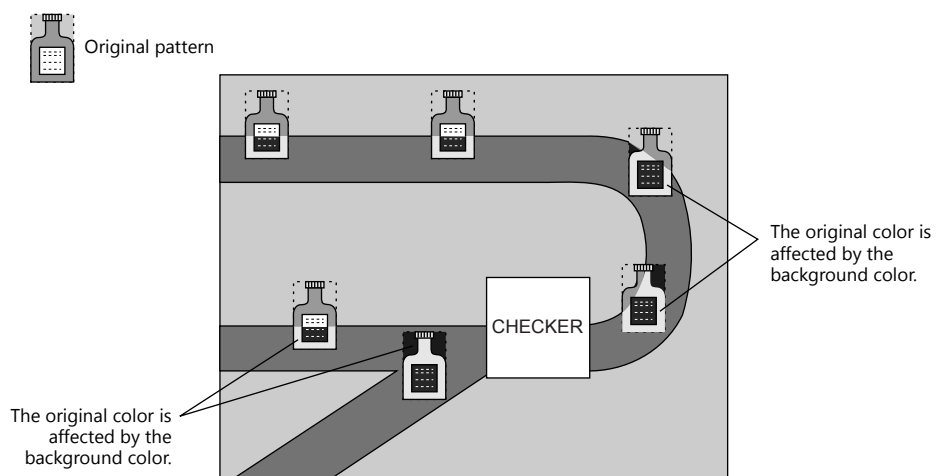

When a transparent pattern is used for animation, colors can be displayed just as they were originally created.

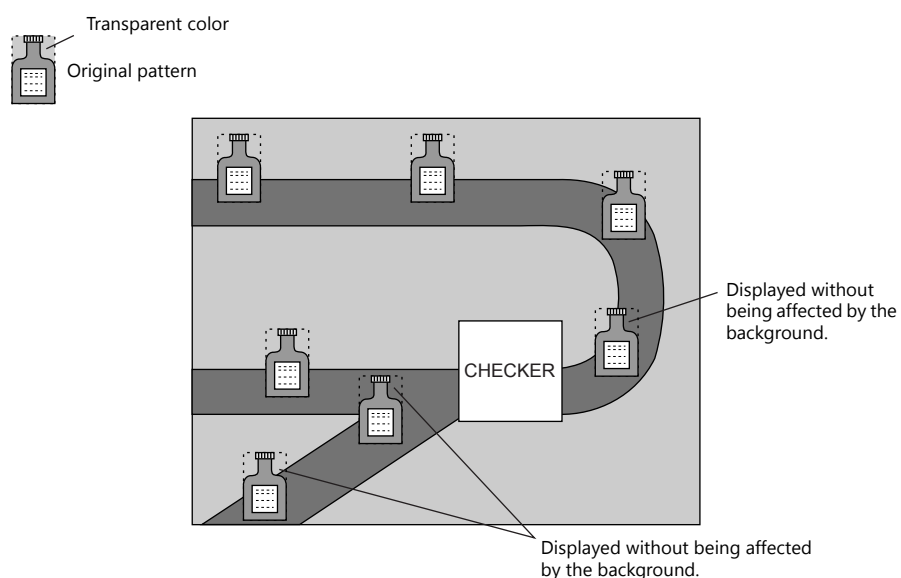

\* Always select the [With Transparent] checkbox for the pattern when using this function.

## Pattern editing

- Set the color not to show on the screen for the [Transparent Color Setting] in the [Pattern Edit] window.
- Only one transparent color can be set per pattern.
- For a pattern like the one below, the perimeter color (red) is set as the transparent color. Consequently, when this pattern is displayed on the screen, the red area becomes transparent and the background color is displayed.

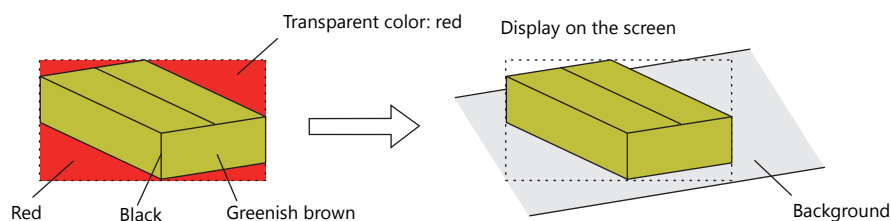

 For details on pattern editing, refer to the V9 Series Operation Manual.

## 11.1.4 Graphic Library (Parameter Settings)

Configure parameter settings to move, transform, and change graphics registered in the graphic library.

### Parameter Targets and Settings

The following drawing items can be set using parameters.

Graphics	Item Specified by Parameter	Refer to
Straight line	Start point, end point	
Continuous line	Point 0 (to n) coordinates	<a href="#">page 11-14</a>
Rectangle	Start point, end point	
Parallelogram	Start point, PX2, PY2, PX3, PY3	<a href="#">page 11-14</a>
Polygon	Center coordinates, radius, start angle, number of corners	
Circle	Center coordinates, radius	
Arc, sector	Center coordinates, radius, start angle, end angle	
Ellipse, elliptical arc, elliptical sector	Center coordinates, X radius, Y radius	
Text	Start point (coordinates at the bottom left of the first character)	
Pattern	Start point (coordinates of the top left corner), (pattern) No.	<a href="#">page 11-15</a>
Paint <sup>*1</sup>	Start point	<a href="#">page 11-15</a>
Graphic call	Start point (library) No.	
Pixel	Start point	
Data display	Start point (coordinates of the bottom left of the first digit), No.	<a href="#">page 11-15</a>

\*1 Paint is not drawn correctly if operation of the graph is set to animation in the parameter settings.

### Continuous line (point 0 (to n) coordinates)

If a continuous line is drawn as shown below, there are seven points at which parameters can be set.

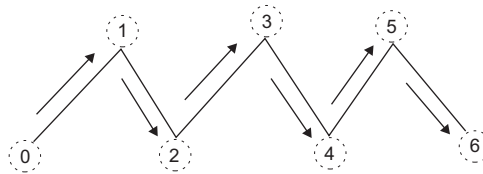

### Parallelogram

- PX2

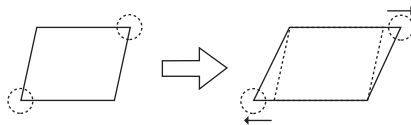

- PY2

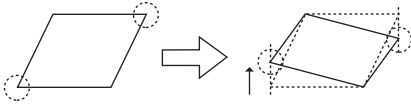

- PX3

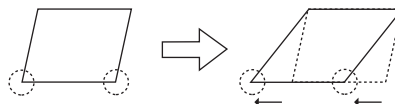

- PY3

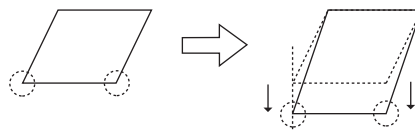

### Pattern

- Start point  
The start point is the top left corner of the pattern, as shown below.

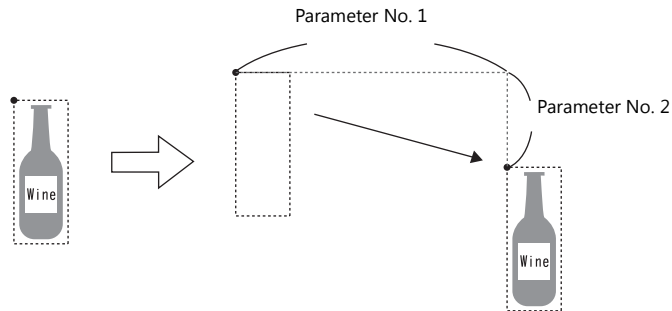

- Pattern No.  
Set the parameters for the numbers to change the picture by specifying a number.

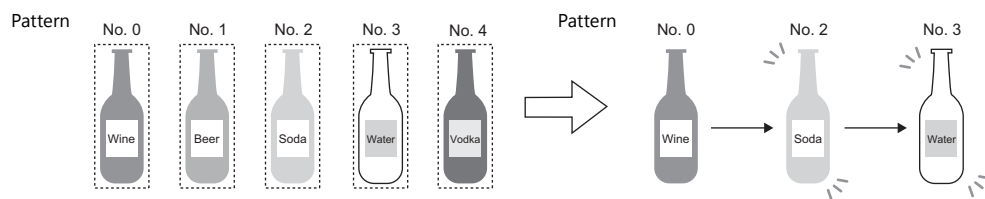

### Paint (start point)

The coordinates of the paint start point can be changed using a parameter device memory.  
Note that drawing is performed using REP instead of XOR so the previous paint display (e.g. circle) will remain.

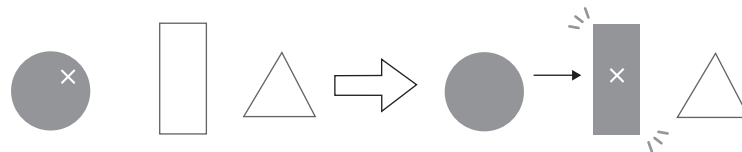

### Data display

The position of the data display can be moved.





## Parameter Settings

Set parameters in the graphic editing window of each graphic.

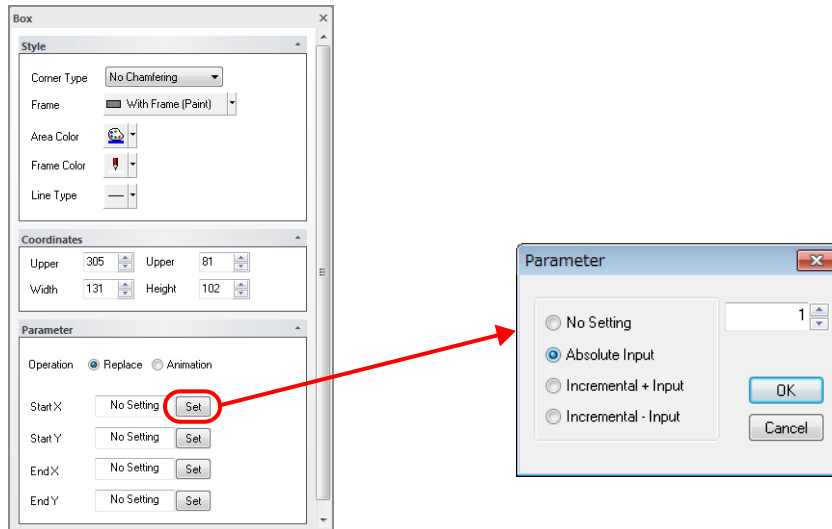

Item	Description
Operation	Select whether to overwrite the previous state or erase the previous state before drawing anew.
Replace	<p>Overwrite the previous state. The previous state will remain.</p> <p>* This setting is available when there is no display area and the [System Setting] → [Unit Setting] → [General Setting] → [General Settings] tab → [Retain previous picture in graphic mode (V8 compatible)] checkbox is selected.</p>
Animation	<p>Always draw the latest state.</p>
Set	Set the parameter of each setting item using the [Set] button.
No Setting	Do not secure a device memory for the parameter.
Absolute Input	<p>Specify the parameter value using absolute coordinates.</p> <p>When specifying coordinates The following shows an example when target coordinate values are specified in a device memory where the coordinates of the top left corner of the screen are [0, 0] and the coordinates of the bottom right corner are [639, 479] (or [319,239]/[799, 599]/[1023, 767]).</p> <p>A circle specified at X = 300 and Y = 200 is displayed at the following location.</p> <p>When specifying numbers (pattern, graphic call) The following shows an example when a registered pattern number or graphic library graphic number is specified directly.</p> <p>If "3" is specified for the parameter device memory, pattern number 3 is displayed.</p>

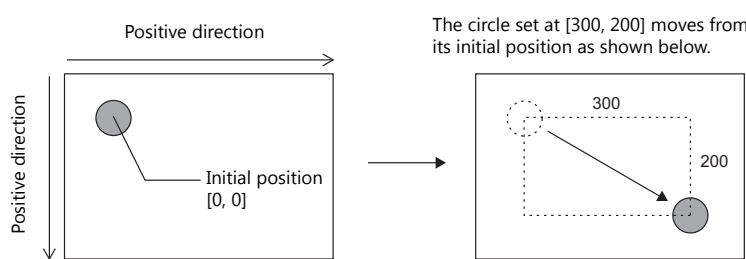
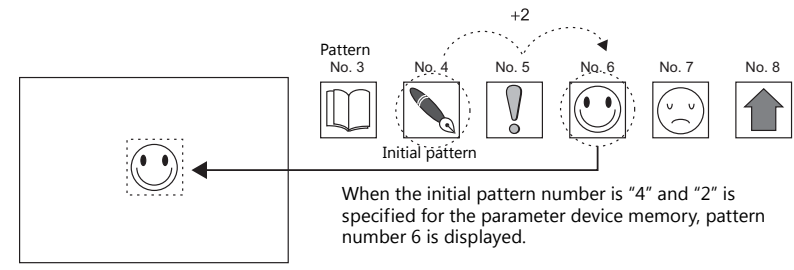
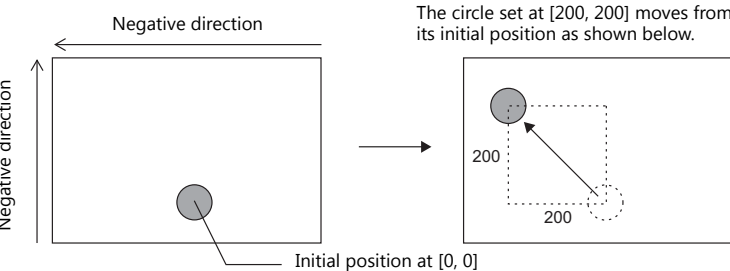
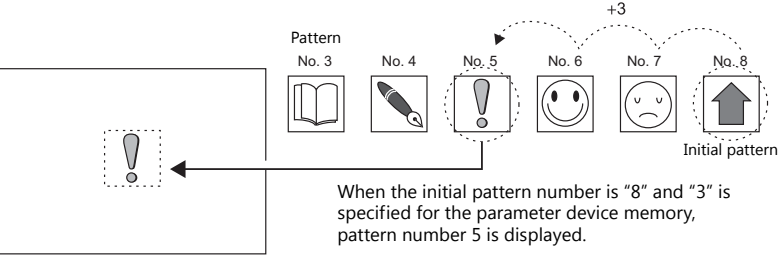
Item	Description
<p>Incremental + Input</p>	<p>Specify the input parameter value using relative coordinates in the positive direction.</p> <p>When specifying coordinates The following shows how the graphic moves in the positive direction when a positive value is specified to the device memory and in the negative direction when a negative value is specified to the device memory where the placement position of the graphic is [0, 0].</p>  <p>The circle set at [300, 200] moves from its initial position as shown below.</p> <p>When specifying numbers (pattern, graphic call) The following shows how a number higher than the placed one is called when a positive value is specified to the device memory and a number lower than the placed one is called when a negative value is specified to the device memory where "0" is set for the number of the placed pattern or graphic.</p>  <p>When the initial pattern number is "4" and "2" is specified for the parameter device memory, pattern number 6 is displayed.</p>
<p>Incremental - Input</p>	<p>Specify the input parameter value using relative coordinates in the negative direction.</p> <p>When specifying coordinates The following shows how the graphic moves in the negative direction when a positive value is specified to the device memory and in the positive direction when a negative value is specified to the device memory where the placement position of the graphic is [0, 0].</p>  <p>The circle set at [200, 200] moves from its initial position as shown below.</p> <p>When specifying numbers (pattern, graphic call) The following shows how a number lower than the placed one is called when a positive value is specified to the device memory and a number higher than the placed one is called when a negative value is specified to the device memory where "0" is set for the number of the placed pattern or graphic.</p>  <p>When the initial pattern number is "8" and "3" is specified for the parameter device memory, pattern number 5 is displayed.</p>

## 11.2 Animation

### 11.2.1 Overview

- When the configured bit is set to ON, the picture is displayed. When the bit is set to OFF, the picture is cleared. Movement can be easily set by switching pictures in a position or by moving a picture.

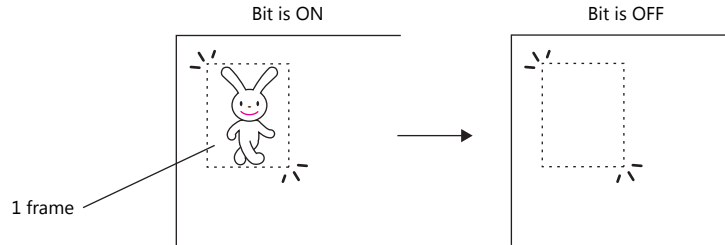

- Graphics can be created with pixels in the "Frame Edit" area. Bitmap data can be imported and used for animation easily.
- An animation image can be made opaque to the background color and display a picture exactly as registered (when transparent color is set). In this case, even if animation pictures overlap each other, the image will not be corrupted or change color.

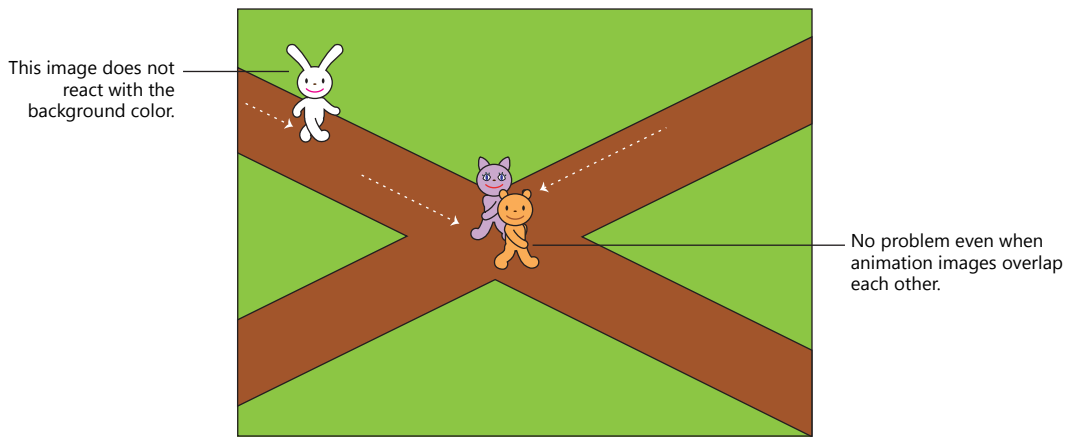

- It is not necessary to create a complicated program on the PLC for animation. Because animation can be created easily using the settings on the V9 series, interesting screens such as screen savers or logo displays can be created with minimal effort.
- Using the scale function, screens can be created in synchronization with the PLC, which reflect the field conditions in real time.

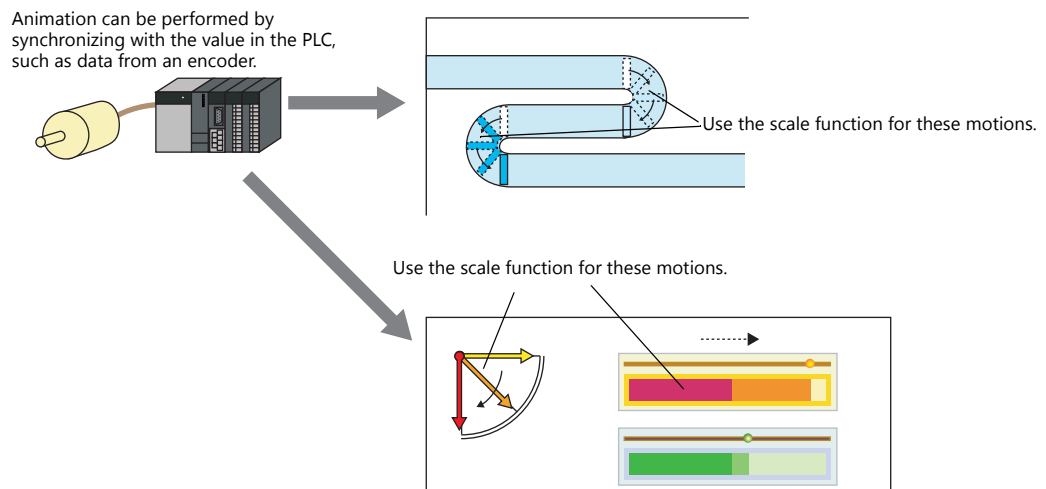

## 11.2.2 Setting Example

### Using an Animation Table

Create the following animation using an animation table.

Display when bit 0 of D100 is set to ON

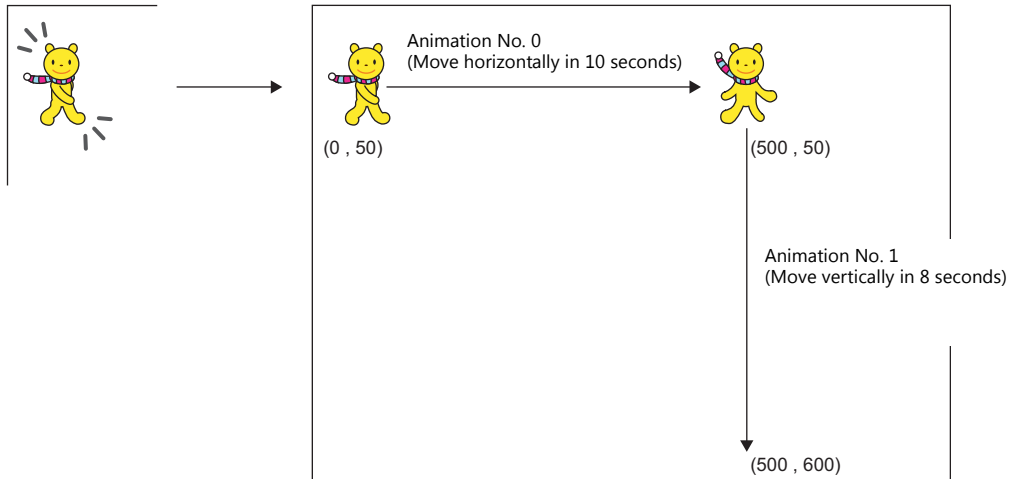

#### 1. Registering animation

1) Click [Home] → [Registration Item] → [Animation]. The [Animation] tab window is displayed.

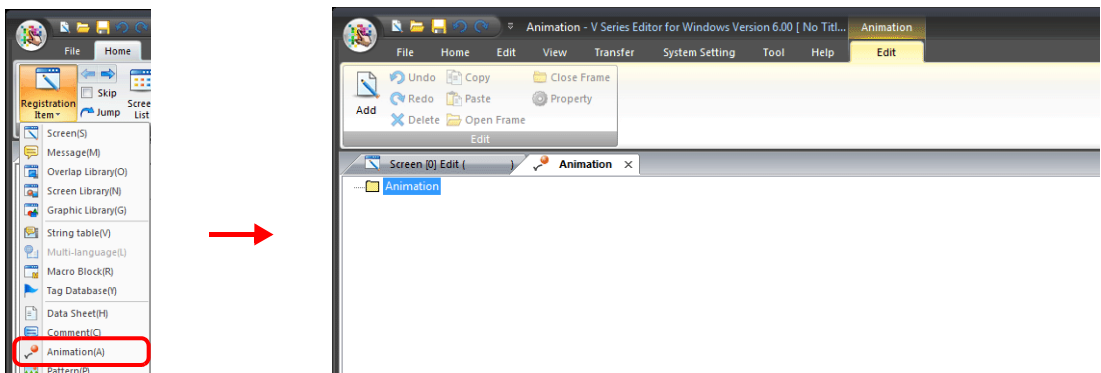

2) Right-click on [Animation], select [Add], and set the [Animation VIEW] settings.

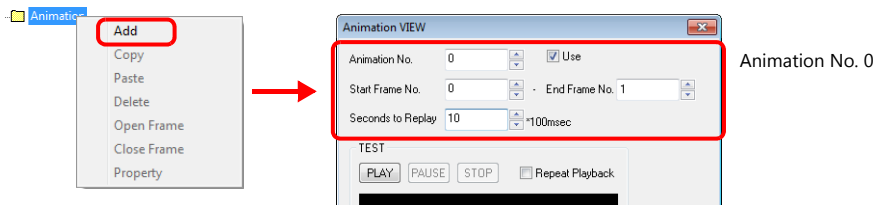

3) Register frame numbers 0 and 1.

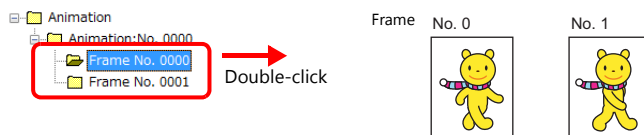

4) In the same manner, create a new animation (animation number 1) and frame numbers 2 and 3.

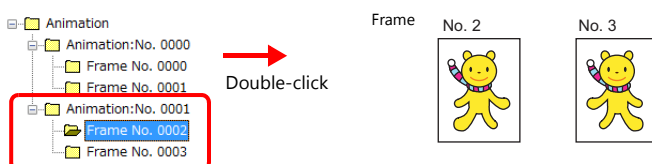

2. Setting animation on the screen

Click [View] → [Function Item] → [Animation Setting] → [New] and configure the animation settings.

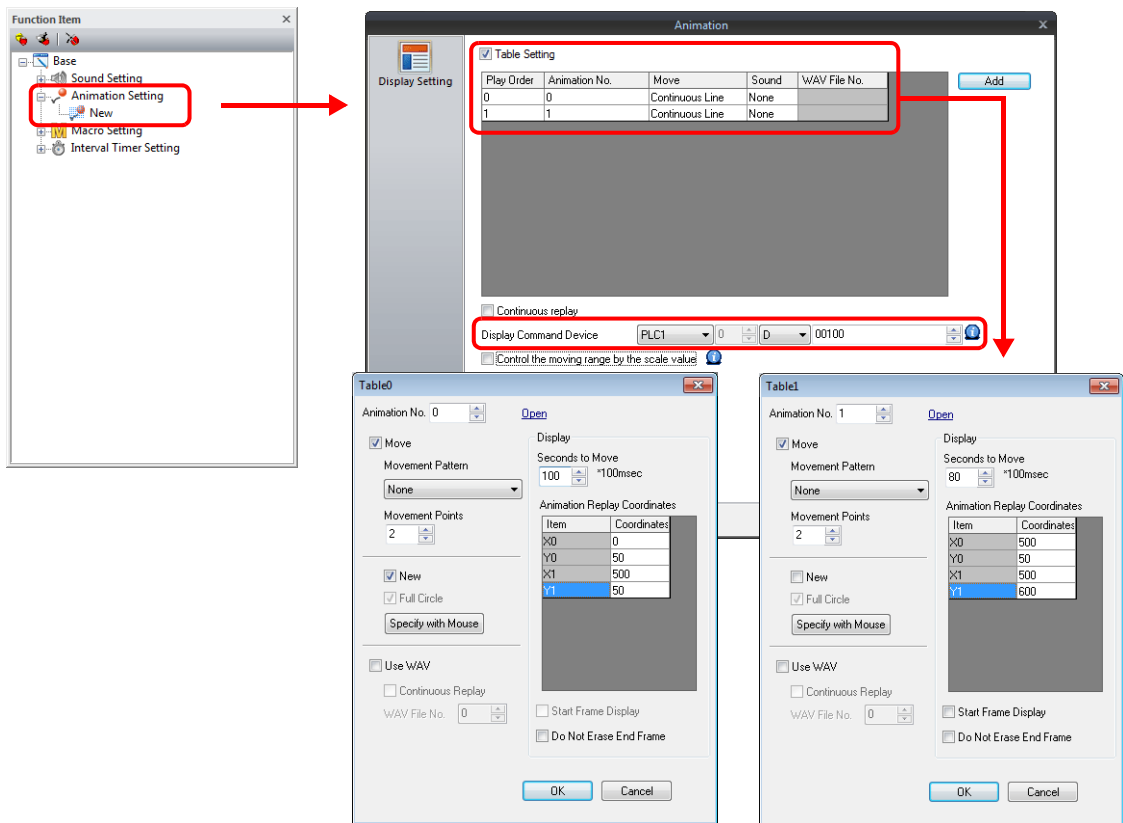

Item	Setting									
Table Setting	Selected									
Table 0	Animation No. 0									
	<table border="1"> <tr> <td>Move: Continuous Line</td> <td>Move</td> </tr> <tr> <td></td> <td>Movement Pattern: None</td> </tr> <tr> <td></td> <td>Movement Points: 2</td> </tr> <tr> <td></td> <td>Seconds to Move: 100* 100 msec</td> </tr> <tr> <td></td> <td>Animation Replay Coordinates X0:Y0 0,50 X1:Y1 500,50</td> </tr> </table>	Move: Continuous Line	Move		Movement Pattern: None		Movement Points: 2		Seconds to Move: 100* 100 msec	
Move: Continuous Line	Move									
	Movement Pattern: None									
	Movement Points: 2									
	Seconds to Move: 100* 100 msec									
	Animation Replay Coordinates X0:Y0 0,50 X1:Y1 500,50									
Table 1	Animation No. 1									
	<table border="1"> <tr> <td>Move: Continuous Line</td> <td>Move</td> </tr> <tr> <td></td> <td>Movement Pattern: None</td> </tr> <tr> <td></td> <td>Movement Points: 2</td> </tr> <tr> <td></td> <td>Seconds to Move: 80* 100 msec</td> </tr> <tr> <td></td> <td>Animation Replay Coordinates X0:Y0 500,50 X1:Y1 500,600</td> </tr> </table>	Move: Continuous Line	Move		Movement Pattern: None		Movement Points: 2		Seconds to Move: 80* 100 msec	
Move: Continuous Line	Move									
	Movement Pattern: None									
	Movement Points: 2									
	Seconds to Move: 80* 100 msec									
	Animation Replay Coordinates X0:Y0 500,50 X1:Y1 500,600									
Continuous replay	None									
Display Command Device	D100									
Control the moving range by the scale value	None									

3. Unit Operation

Set bit 0 of D100 to ON. The animation is displayed.

## Using Scaling (With Movement)

Create the following animation using scaling. Animation movement is controlled by the change in the scaling value.

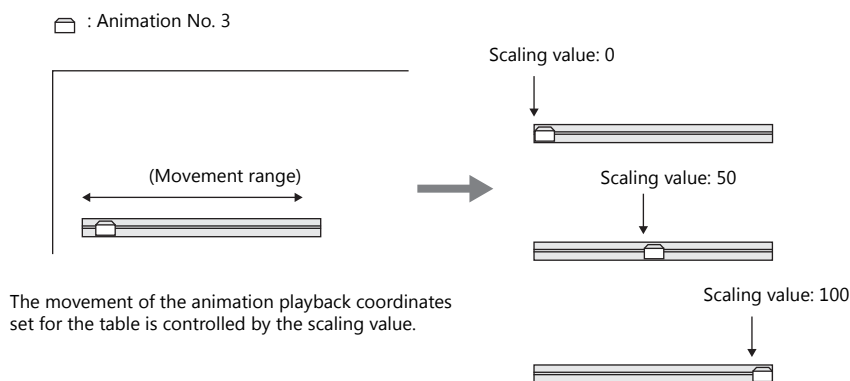

### 1. Registering animation

1) Click [Home] → [Registration Item] → [Animation]. The [Animation] tab window is displayed.

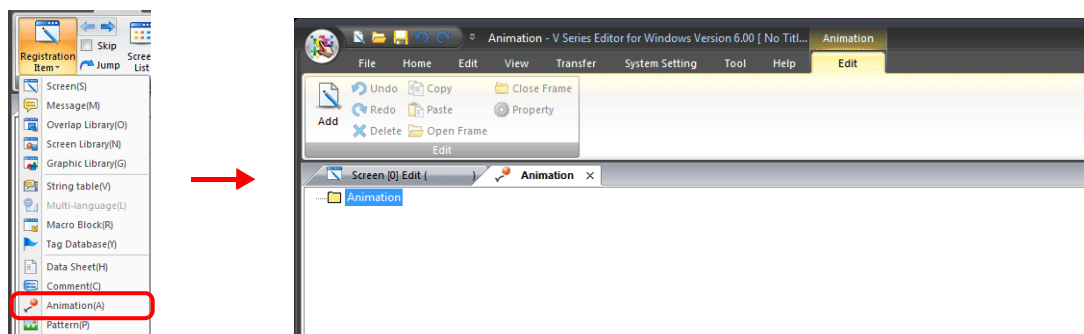

2) Right-click on [Animation], select [Add], and set the [Animation VIEW] settings.

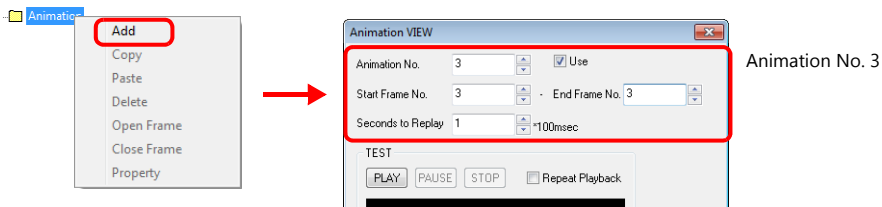

3) Register frame number 3.

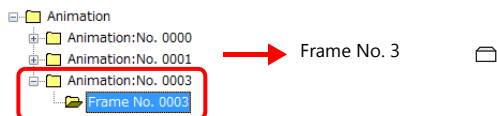

### 2. Setting animation on the screen

Click [View] → [Function Item] → [Animation Setting] → [New] and configure the animation settings.

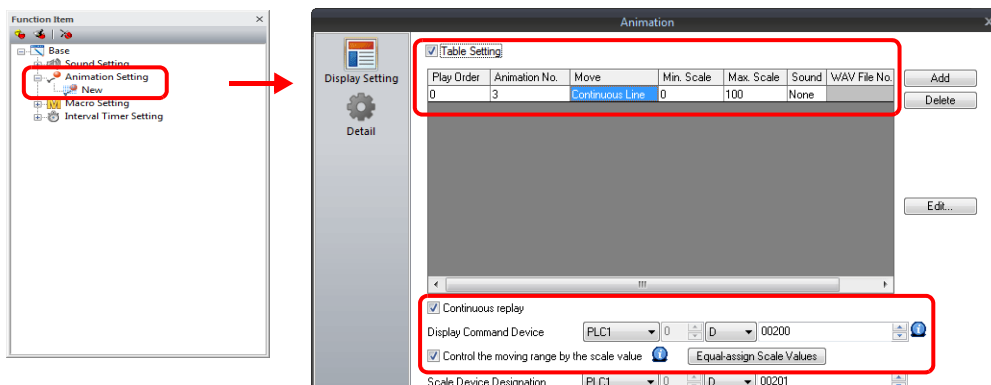

Item	Setting	
Table Setting	Selected	
Table 0	Animation No. 3	
	Move: Continuous Line	Move
		Movement Pattern: None
		Movement Points: 2
		Animation Replay Coordinates X0:Y0 0,50 X1:Y1 500,50
	Scale values	0 to 100
	No sound	
Continuous replay	None	
Display Command Device	D200	
Control the moving range by the scale value	Selected	
Scale Device Designation	D201	

3. Unit Operation

- 1) Set bit 0 of D200 to ON. The animation is displayed.
- 2) Set the scaling value of D201 to move the animation.

**Using Scaling (Without Movement)**

Create the following animation. The timing to switch the animation number can be specified using a scaling value.

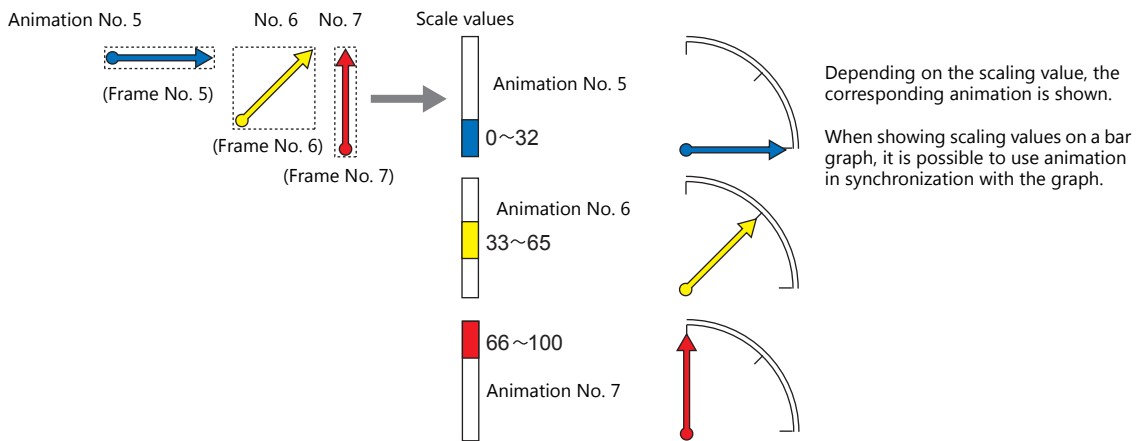

1. Registering animation

- 1) Click [Home] → [Registration Item] → [Animation]. The [Animation] tab window is displayed.

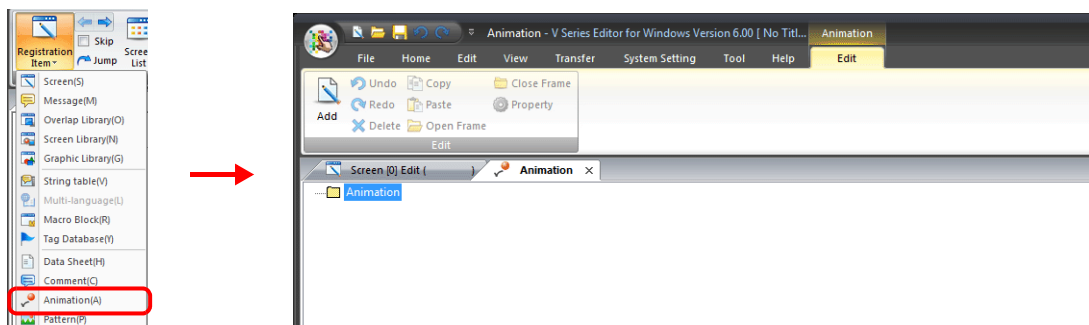

- 2) Right-click on [Animation], select [Add], and set the [Animation VIEW] settings.

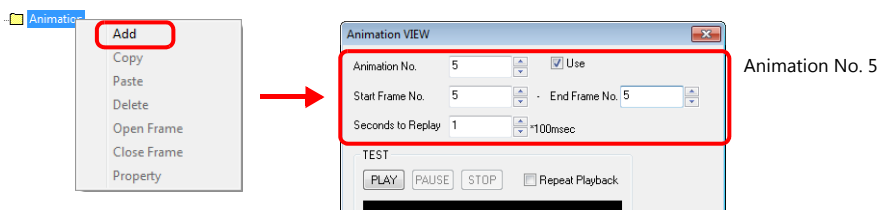

3) Register frame number 5.

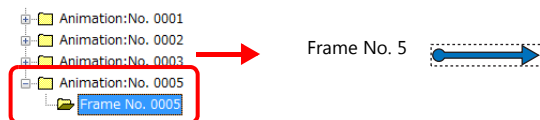

4) In the same manner, register animation number 6 (frame number 6) and animation number 7 (frame number 7).

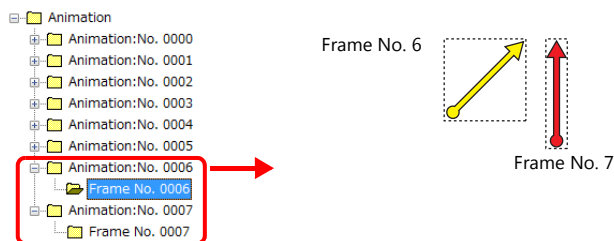

2. Setting animation on the screen

1) Click [View] → [Function Item] → [Animation Setting] → [New] and configure the animation settings.

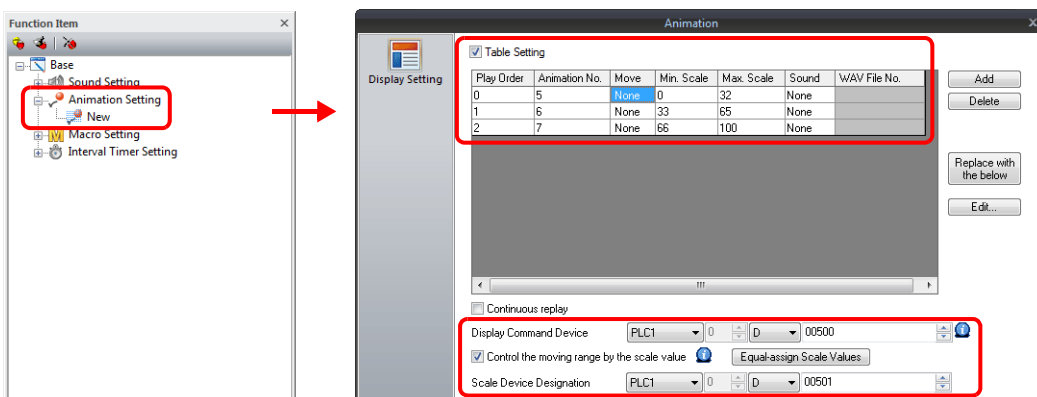

Item	Setting		
Table Setting	Selected		
Table 0	Animation No. 5		
	No movement	Animation playback coordinates X, Y 100, 100	
	Scale values	0 to 32	
	No sound		
	Table 1	Animation No. 6	
		No movement	Animation playback coordinates X, Y 100, 100
		Scale values	33 to 65
		No sound	
	Table 2	Animation No. 7	
		No movement	Animation playback coordinates X, Y 100, 100
		Scale values	66 to 100
		No sound	
Continuous replay	None		
Display Command Device	D500		
Control the moving range by the scale value	Selected		
Scale Device Designation	D501		

3. Unit Operation

- 1) Set bit 0 of D500 to ON. The animation is displayed.
- 2) Set the scaling value of D501 to change the animation number.



## 11.2.3 Detailed Settings

### Registering Animation

Animations are defined and registered in the [Animation] tab window.

### Opening the Registration Window

Click [Home] → [Registration Item] → [Animation] to display the [Animation] tab window.  
 Configure settings in the [Animation VIEW] window and perform frame editing in this window.

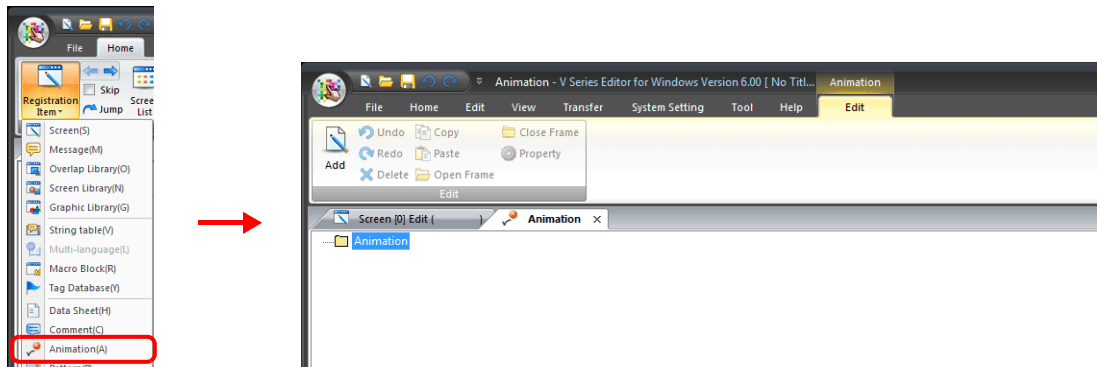

The menu items on the right-click menu differ depending on the folder that was right-clicked, [Animation], [Animation No. xxxx] or [Frame No. xxxx].

- [Animation] folder

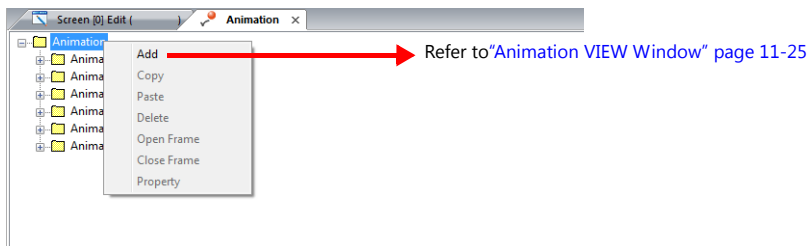

- [Animation No. xxxx] folder

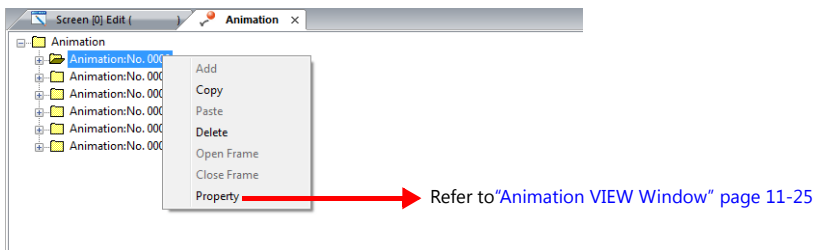

- [Frame No. xxxx] folder

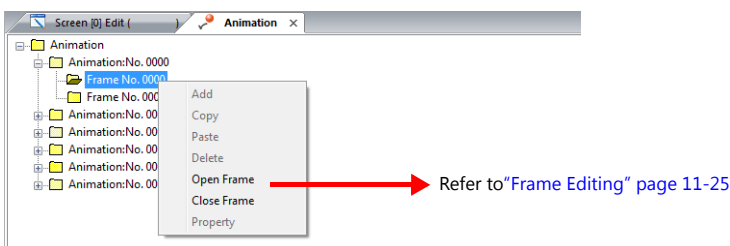

## Animation VIEW Window

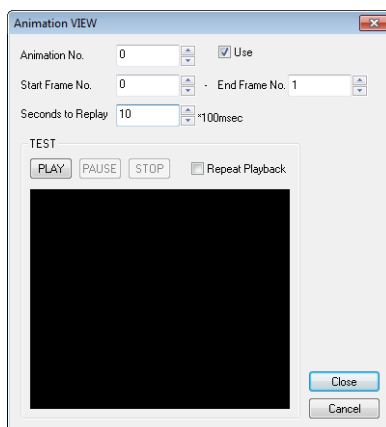

Item	Description								
Use	When this checkbox is selected, an animation number is set. To clear the setting, deselect this checkbox.								
Animation No.	Displays the animation number currently being edited. The animation number can be changed by clicking the up/down arrow buttons. Values can also be entered directly without using the up/down buttons. Setting range: 0 to 1023								
Start Frame No. - End Frame No.	Set the range (number) of frames *1 to be used for animation. Setting range: 0 to 1022								
Seconds to Replay (× 100 msec) *2	Set the cycle (speed) for changing the frames specified for [Start Frame No.] and [End Frame No.].								
TEST	When the frames have been registered, the actual motion of the animation can be checked. <table border="1" style="width: 100%;"> <tr> <td>PLAY</td> <td>The set frame is displayed within the time set for [Seconds to Replay].</td> </tr> <tr> <td>PAUSE</td> <td>Pause playback.</td> </tr> <tr> <td>STOP</td> <td>Stop playback.</td> </tr> <tr> <td>Repeat Playback</td> <td>Normally playback is only performed once when the [PLAY] button is clicked. Select this checkbox to enable continuous playback.</td> </tr> </table>	PLAY	The set frame is displayed within the time set for [Seconds to Replay].	PAUSE	Pause playback.	STOP	Stop playback.	Repeat Playback	Normally playback is only performed once when the [PLAY] button is clicked. Select this checkbox to enable continuous playback.
PLAY	The set frame is displayed within the time set for [Seconds to Replay].								
PAUSE	Pause playback.								
STOP	Stop playback.								
Repeat Playback	Normally playback is only performed once when the [PLAY] button is clicked. Select this checkbox to enable continuous playback.								

\*1 A "frame" refers to a single image used in animation. Drawing is performed on a pixel unit basis.

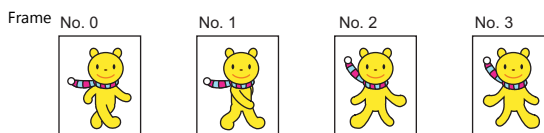

\*2 Display example  
 Start Frame No.: 5  
 End Frame No.: 9  
 Seconds to Replay: 30 × 100 msec  
 Animation is performed as shown below.

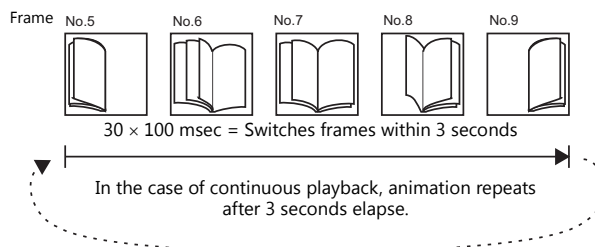

## Frame Editing

- For details on frame editing and registration, refer to the V9 Series Operation Manual.
- A maximum of 1023 frames can be registered (0 to 1022).

# Animation Settings

## Display Settings

### [Table Setting]: Unselected

Specify one animation number for playback. Specifying a device memory address allows changing the animation number and display position.

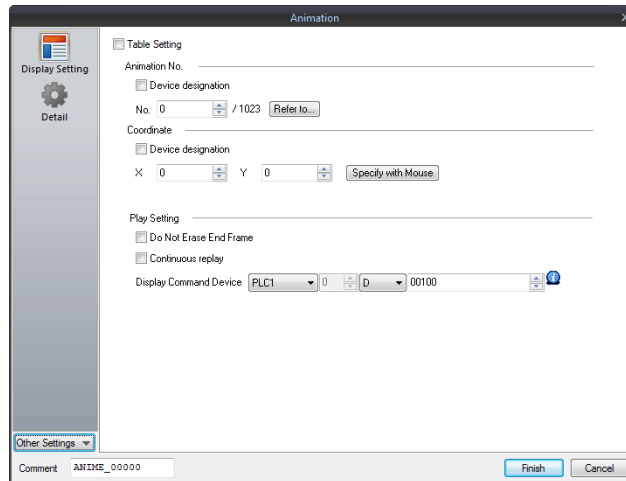

Item	Description																																				
Animation No.	Set the animation number specification method. Unselected: Set one animation number. Selected: Set the animation number using a device memory.																																				
Coordinate	Set the display position of the animation. Unselected: Set the X and Y coordinates. Selected: Set the X and Y coordinates using a device memory.																																				
Play Setting	<table border="1"> <tr> <td>Do Not Erase End Frame *1</td> <td>Set the operation to perform when animation playback ends. Unselected On completion of playback, the image disappears even if the command bit remains ON.  Selected The end frame is shown even after completion of replay while the command bit remains ON. When the command bit is set to OFF, the end frame disappears.</td> </tr> <tr> <td>Continuous replay</td> <td>Set the number of times to play back the animation. Unselected: The animation is played back only once. Selected: The animation is played back continuously.</td> </tr> </table>	Do Not Erase End Frame *1	Set the operation to perform when animation playback ends. Unselected On completion of playback, the image disappears even if the command bit remains ON.  Selected The end frame is shown even after completion of replay while the command bit remains ON. When the command bit is set to OFF, the end frame disappears.	Continuous replay	Set the number of times to play back the animation. Unselected: The animation is played back only once. Selected: The animation is played back continuously.																																
Do Not Erase End Frame *1	Set the operation to perform when animation playback ends. Unselected On completion of playback, the image disappears even if the command bit remains ON.  Selected The end frame is shown even after completion of replay while the command bit remains ON. When the command bit is set to OFF, the end frame disappears.																																				
Continuous replay	Set the number of times to play back the animation. Unselected: The animation is played back only once. Selected: The animation is played back continuously.																																				
Display Command Device	<p>This is the device memory to be used for displaying the animation on the screen.</p> <table border="1"> <thead> <tr> <th>MSB</th> <th>15</th> <th>14</th> <th>13</th> <th>12</th> <th>11</th> <th>10</th> <th>09</th> <th>08</th> <th>07</th> <th>06</th> <th>05</th> <th>04</th> <th>03</th> <th>02</th> <th>01</th> <th>00</th> <th>LSB</th> </tr> </thead> <tbody> <tr> <td></td> <td>0</td> <td>0</td> <td>0</td> <td>0</td> <td>0</td> <td>0</td> <td>0</td> <td>0</td> <td>0</td> <td>0</td> <td>0</td> <td>0</td> <td>0</td> <td></td> <td></td> <td></td> <td></td> </tr> </tbody> </table> <p>System reserved ("0" setting) (bits 15-07) (3) Pause/resume movement (bits 06-04) (2) Pause/resume playback (bits 03-02) (1) Show/hide animation (bit 01)</p> <p>(1) Show/hide animation (bit 0) [1] (ON): Show the corresponding animation number. [0] (OFF): Hide the currently displayed animation.</p> <p>(2) Pause/resume playback (bit 1) [1] (ON): Pause the currently playing animation. [0] (OFF): Resume playback of the paused animation.</p> <div style="display: flex; justify-content: space-around; align-items: center;"> <div style="text-align: center;"> <p>Playing</p> <p>Frames are switched in accordance with the animation setting.</p> </div> <div style="text-align: center;"> <p>Paused</p> <p>The animation pauses with the frame displayed when bit 1 is set to ON.</p> </div> </div> <p style="text-align: center;">Set bit 1 to ON.</p>	MSB	15	14	13	12	11	10	09	08	07	06	05	04	03	02	01	00	LSB		0	0	0	0	0	0	0	0	0	0	0	0	0				
MSB	15	14	13	12	11	10	09	08	07	06	05	04	03	02	01	00	LSB																				
	0	0	0	0	0	0	0	0	0	0	0	0	0																								

Continued

Item		Description
Play Setting	Display Command Device	(3) Pause/resume movement (bit 2) *2 [1] (ON): Pause the currently moving animation. [0] (OFF): Resume movement of the animation.

\*1 Do Not Erase End Frame

- Checkbox unselected

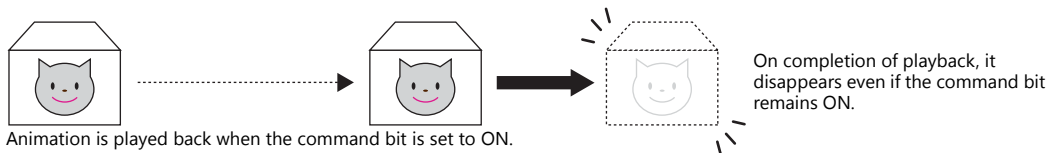

- Checkbox selected
- Animation can be shown or hidden according to the status of the command device memory, which facilitates display control from an external device.

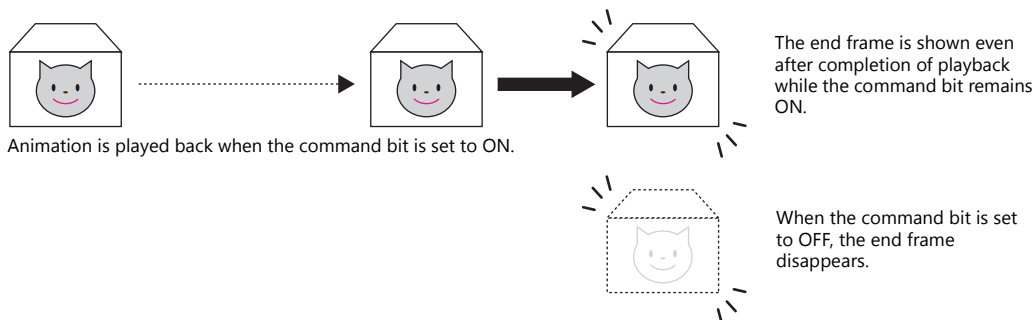

\*2 Pause/resume movement (bit 2)

- When movement is selected on the animation table ([Table Setting]: selected), movement is resumed from the position where it was paused.

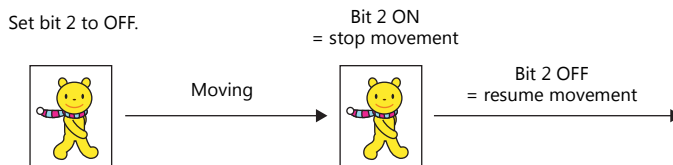

- When movement occurs using the coordinates specified by a device memory address, movement resumes according to the value specified for [Display Command Device].

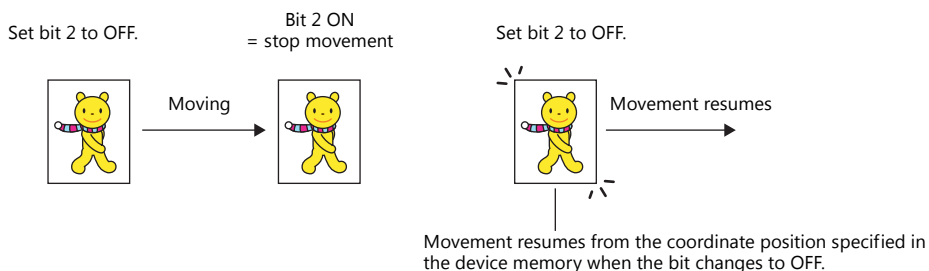

**[Table Setting]: selected**

The multiple animations registered in the table are played back in order.

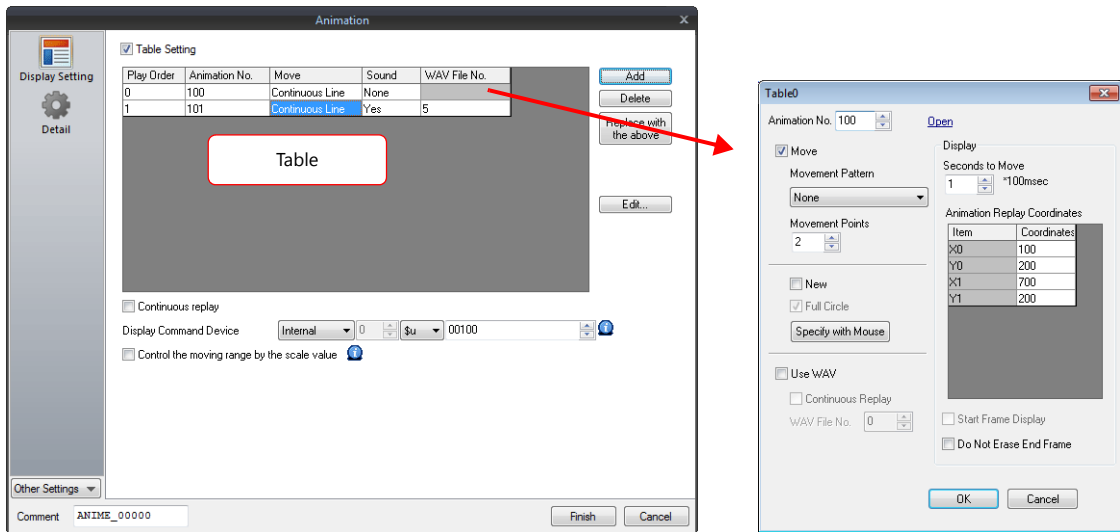

Item	Description																																																					
Table	Register animation numbers to play back using the [Add] button. Refer to "Table 0 to 15" page 11-29.																																																					
Continuous replay	Set the number of times to play back the animation. Unselected: The animation is played back only once. Selected: The animation is played back continuously.																																																					
Display Command Device	This is the device memory to be used for displaying the animation on the screen. <div style="text-align: center;"> <table border="1" style="margin: auto;"> <tr> <td colspan="15" style="text-align: left;">MSB</td> <td colspan="2" style="text-align: right;">LSB</td> </tr> <tr> <td>15</td><td>14</td><td>13</td><td>12</td><td>11</td><td>10</td><td>09</td><td>08</td><td>07</td><td>06</td><td>05</td><td>04</td><td>03</td><td>02</td><td>01</td><td>00</td><td></td><td></td> </tr> <tr> <td>0</td><td>0</td><td>0</td><td>0</td><td>0</td><td>0</td><td>0</td><td>0</td><td>0</td><td>0</td><td>0</td><td>0</td><td>0</td><td></td><td></td><td></td><td></td><td></td> </tr> </table> <p style="text-align: center;"> <span style="margin-right: 100px;">System reserved ("0" setting)</span> <span>(3) Pause/resume movement</span>  <span style="margin-right: 50px;">(2) Pause/resume playback</span>  <span>(1) Show/hide animation</span> </p> </div> <p>(1) Show/hide animation (bit 0)                      [1] (ON): Show the corresponding animation number.                      [0] (OFF): Hide the currently displayed animation.</p> <p>(2) Pause/resume playback (bit 1)                      [1] (ON): Pause the currently playing animation.                      [0] (OFF): Resume playback of the paused animation.</p> <div style="text-align: center;"> <p style="text-align: center;">Frames are switched in accordance with the animation setting.</p> </div> <p>(3) Pause/resume movement (bit 2) *1                      [1] (ON): Pause the currently moving animation.                      [0] (OFF): Resume movement of the animation.</p>	MSB															LSB		15	14	13	12	11	10	09	08	07	06	05	04	03	02	01	00			0	0	0	0	0	0	0	0	0	0	0	0	0					
MSB															LSB																																							
15	14	13	12	11	10	09	08	07	06	05	04	03	02	01	00																																							
0	0	0	0	0	0	0	0	0	0	0	0	0																																										
Control the moving range by the scaling value	Use a scaling value. The settings for scaling values are available when this checkbox is selected. Refer to "Scaling" page 11-32.																																																					

\*1 For details, refer to page 11-27.

**Table 0 to 15**

Register up to 16 animations to play back in sequence.

Item	Description																							
Animation No.	Set the animation number to play back.																							
Move	Set whether or not to move the animation. Unselected: No movement Selected: Move																							
No movement	Configure the following settings. <table border="1" style="width: 100%; margin-top: 5px;"> <tr> <td>Animation Replay Coordinates</td> <td>Set the display position of the animation.</td> </tr> <tr> <td>Seconds to Move (x 100 msec)</td> <td>Set the playback time for the set animation number.</td> </tr> </table>	Animation Replay Coordinates	Set the display position of the animation.	Seconds to Move (x 100 msec)	Set the playback time for the set animation number.																			
Animation Replay Coordinates	Set the display position of the animation.																							
Seconds to Move (x 100 msec)	Set the playback time for the set animation number.																							
Move	Set the following items for straight line path. <table border="1" style="width: 100%; margin-top: 5px;"> <tr> <td>Movement Pattern *1</td> <td>None</td> </tr> <tr> <td>Movement Points</td> <td>Specify the number of movement points. Range: 2 to 32</td> </tr> <tr> <td>Animation Replay Coordinates</td> <td>Specify the coordinates of the movement points. These can be specified with direct input or by using the mouse.</td> </tr> <tr> <td>New *2 Specify with Mouse</td> <td>Specify the coordinates of the movement points using the mouse. Not set: Selected Already set: Unselected</td> </tr> <tr> <td>Seconds to Move (x 100 msec)</td> <td>Set the movement time for the set animation number.</td> </tr> </table> <p>Set the following items for circular and arc-like paths.</p> <table border="1" style="width: 100%; margin-top: 5px;"> <tr> <td rowspan="2">Movement Pattern *1</td> <td>Circle (Clockwise)</td> </tr> <tr> <td>Circle (Counterclockwise)</td> </tr> <tr> <td>No. of Divisions *1</td> <td>Specify the number of divisions of the circumference. Range: 2 to 31</td> </tr> <tr> <td>Animation Replay Coordinates</td> <td>Specify the coordinates of the movement points. These can be specified with direct input or by using the mouse.</td> </tr> <tr> <td>New *2 Specify with Mouse</td> <td>Specify the coordinates of the movement points using the mouse. Not set: Selected Already set: Unselected</td> </tr> <tr> <td>Full Circle *2</td> <td>Select this checkbox when a full circle is used for the path.</td> </tr> <tr> <td>Seconds to Move (x 100 msec)</td> <td>Set the movement time for the set animation number.</td> </tr> </table>	Movement Pattern *1	None	Movement Points	Specify the number of movement points. Range: 2 to 32	Animation Replay Coordinates	Specify the coordinates of the movement points. These can be specified with direct input or by using the mouse.	New *2 Specify with Mouse	Specify the coordinates of the movement points using the mouse. Not set: Selected Already set: Unselected	Seconds to Move (x 100 msec)	Set the movement time for the set animation number.	Movement Pattern *1	Circle (Clockwise)	Circle (Counterclockwise)	No. of Divisions *1	Specify the number of divisions of the circumference. Range: 2 to 31	Animation Replay Coordinates	Specify the coordinates of the movement points. These can be specified with direct input or by using the mouse.	New *2 Specify with Mouse	Specify the coordinates of the movement points using the mouse. Not set: Selected Already set: Unselected	Full Circle *2	Select this checkbox when a full circle is used for the path.	Seconds to Move (x 100 msec)	Set the movement time for the set animation number.
Movement Pattern *1	None																							
Movement Points	Specify the number of movement points. Range: 2 to 32																							
Animation Replay Coordinates	Specify the coordinates of the movement points. These can be specified with direct input or by using the mouse.																							
New *2 Specify with Mouse	Specify the coordinates of the movement points using the mouse. Not set: Selected Already set: Unselected																							
Seconds to Move (x 100 msec)	Set the movement time for the set animation number.																							
Movement Pattern *1	Circle (Clockwise)																							
	Circle (Counterclockwise)																							
No. of Divisions *1	Specify the number of divisions of the circumference. Range: 2 to 31																							
Animation Replay Coordinates	Specify the coordinates of the movement points. These can be specified with direct input or by using the mouse.																							
New *2 Specify with Mouse	Specify the coordinates of the movement points using the mouse. Not set: Selected Already set: Unselected																							
Full Circle *2	Select this checkbox when a full circle is used for the path.																							
Seconds to Move (x 100 msec)	Set the movement time for the set animation number.																							
Use WAV	Set whether or not to play an audio file. Unselected: No playback. Selected: Play back an audio file. The following movement settings become available when this checkbox is selected. <table border="1" style="width: 100%; margin-top: 5px;"> <tr> <td>Continuous Replay</td> <td>Continuously play back an audio file.</td> </tr> <tr> <td>WAV File No.</td> <td>Set the audio file number.</td> </tr> </table>	Continuous Replay	Continuously play back an audio file.	WAV File No.	Set the audio file number.																			
Continuous Replay	Continuously play back an audio file.																							
WAV File No.	Set the audio file number.																							
Start Frame Display *3	Baton pass animation can be performed. This setting is available for tables other than table number 0.																							
Do Not Erase End Frame *4	Set the operation to perform when animation playback ends. Unselected On completion of playback, the image disappears even if the command bit remains ON. Selected The end frame is shown even after completion of replay while the command bit remains ON. When the command bit is set to OFF, the end frame disappears.																							

\*1 Movement Pattern/Movement Points/No. of Divisions

Example: Straight line  
[Movement Points]: 6

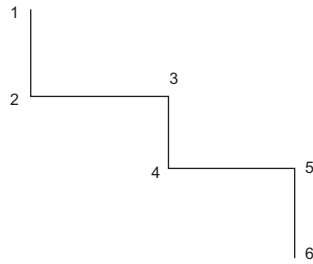

Example: Circle  
[No. of Divisions]: 20

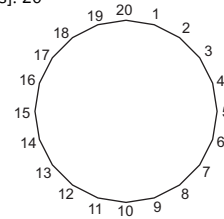

\*2 [Specify with Mouse]/[New]

- When [Movement Pattern] is set to "None", click the desired points on the screen in the same way as drawing a continuous straight line. The coordinates are defined in order. Double-click to accept the points and display the window again. The number of clicks is automatically set for [Movement Points]. Specifying with mouse is automatically finished when 32 points are set.

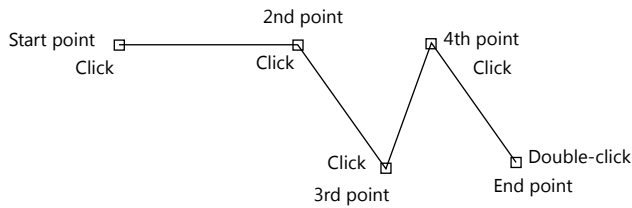

- When [Movement Pattern] is set to "Circle (Clockwise/Counterclockwise)" with [Full Circle], specify the start and end points.



- When [Movement Pattern] is set to "Circle (Clockwise/Counterclockwise)" with [Arc], specify the start and end points.

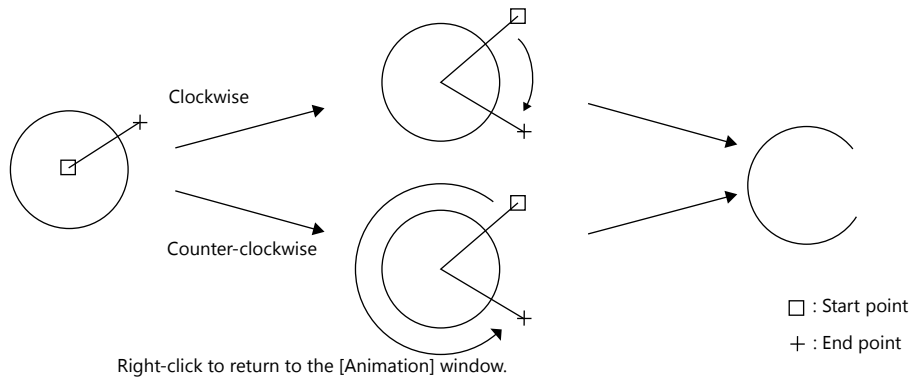

A configured path can be modified by clicking [Specify with Mouse] when the [New] checkbox is unselected. To show the path on the editing screen, select the [Display Animation Paths] checkbox in the [Display Environment] window. A straight line, continuous straight line, circle, or arc created by drawing is displayed in the editing window.

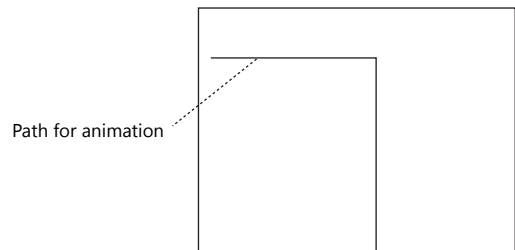
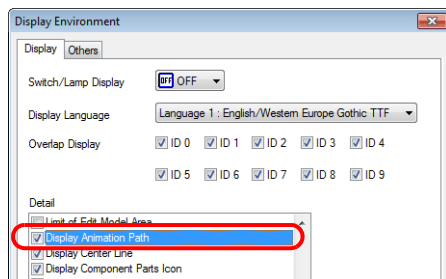

## \*3 Start Frame Display

- : Animation table No. 0
- : Animation table No. 1, with start frame display
- : Animation table No. 2, with start frame display
- : Animation table No. 3, with start frame display

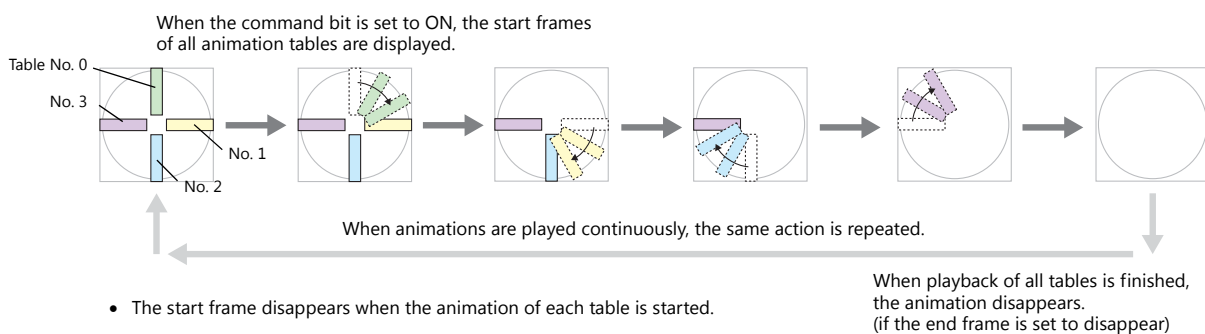

\*4 For details, refer to [page 11-27](#).



## Scaling

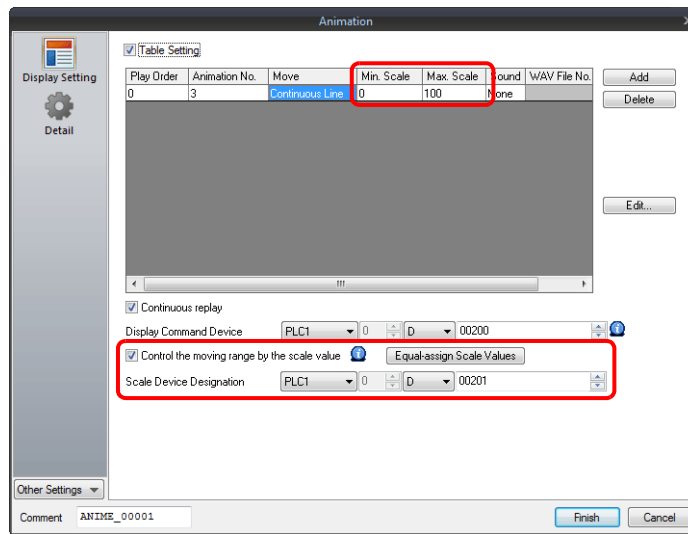

Item	Description
Control the moving range by the scaling value <sup>*1</sup>	Use a scaling value. The following setting items for scaling values become active.
Scale Device Designation	Set the device memory that specifies the scaling value.
Min. Scale	Set the minimum scaling value of the animation table.
Max. Scale	Set the maximum scaling value of the animation table.
Equal-assign Scale Values <sup>*2</sup>	Equally assign scaling values to the animation in the table.

\*1 Difference between using and not using scaling values

- When scaling values are not used:

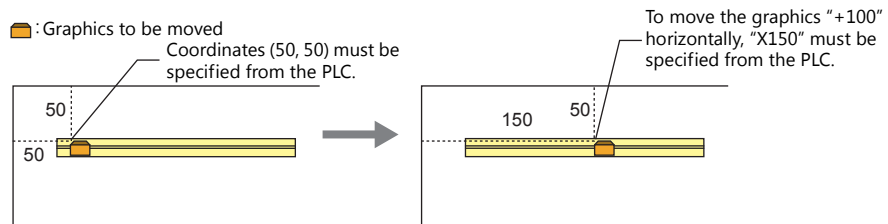

- When scaling values are used:

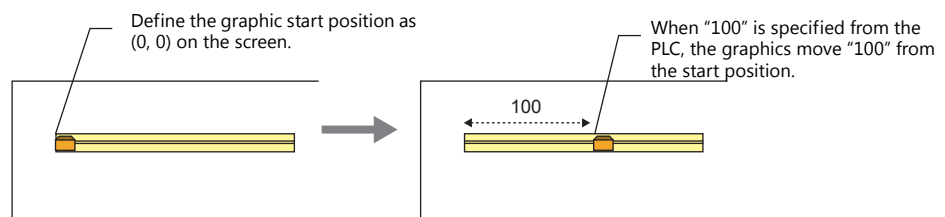

\*2 Setting example

When assigning scaling values equally in the range from 0 to 3000 using animation tables No. 0 to No. 2 :

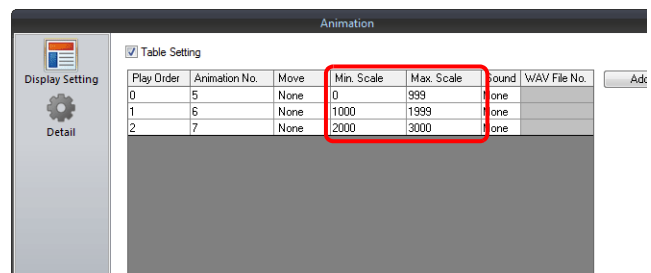
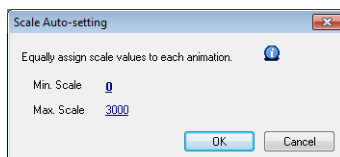

## Detail

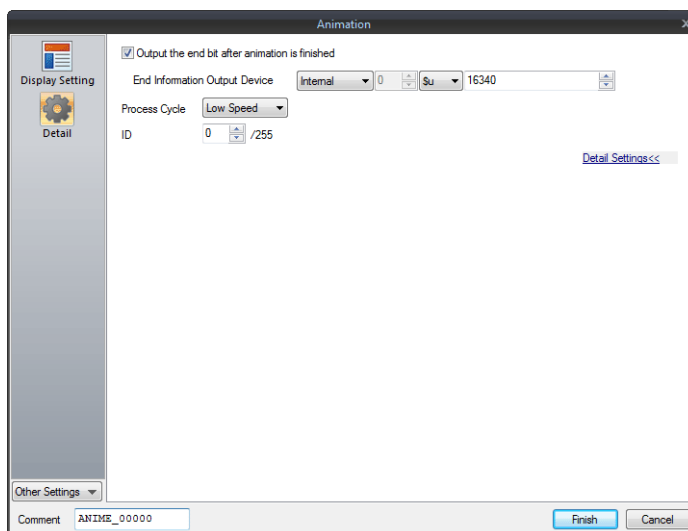

Item	Description																																
Output the end bit after animation is finished	<p>This is the device memory to be used for checking the status of animation.</p> <ul style="list-style-type: none"> <li>In the case of device memory designation, the end bit is output when the animation playback time (seconds) has elapsed.</li> <li>In the case of using an animation table, the end bit is output when all of the animations in the animation table have been played back.</li> <li>If the animation is finished halfway through playback, the end bit is not output.</li> <li>The end bit is not output when using scaling.</li> </ul> <p>MSB <span style="float: right;">LSB</span></p> <table border="1" style="width: 100%; text-align: center;"> <tr> <td>15</td><td>14</td><td>13</td><td>12</td><td>11</td><td>10</td><td>09</td><td>08</td><td>07</td><td>06</td><td>05</td><td>04</td><td>03</td><td>02</td><td>01</td><td>00</td> </tr> <tr> <td>0</td><td>0</td><td>0</td><td>0</td><td>0</td><td>0</td><td>0</td><td>0</td><td>0</td><td>0</td><td>0</td><td>0</td><td>0</td><td>0</td><td>0</td><td></td> </tr> </table> <p style="text-align: center;"> <span style="display: inline-block; width: 70%; border-top: 1px solid black; margin-bottom: 5px;"></span>             System reserved ("0" setting)             <span style="display: inline-block; width: 20%; border-top: 1px solid black; margin-bottom: 5px;"></span>             End of animation         </p>	15	14	13	12	11	10	09	08	07	06	05	04	03	02	01	00	0	0	0	0	0	0	0	0	0	0	0	0	0	0	0	
15	14	13	12	11	10	09	08	07	06	05	04	03	02	01	00																		
0	0	0	0	0	0	0	0	0	0	0	0	0	0	0																			
Process Cycle	Set a cycle for the V9 series to read the PLC data while it is communicating with the PLC. For details, refer to "1.2 Process Cycle".																																
ID	Set the ID.																																

## 11.2.4 Notes

### Animation Setting Position

An animation can be set only on a base screen. Note that you cannot register it on an overlap screen.

### Transparency

A part of a picture (frame) in the registered animation can be hidden.

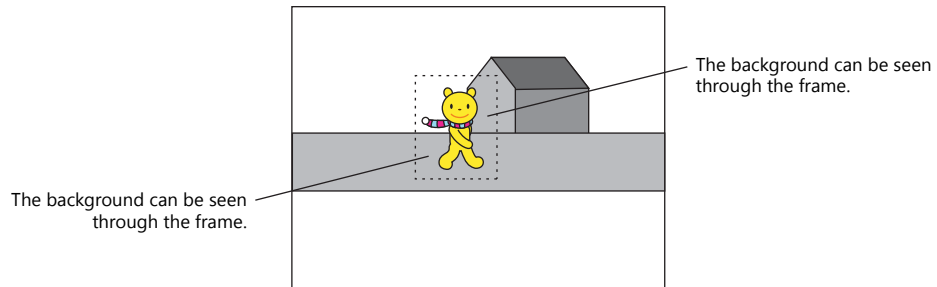

### Transparent color setting for frame

1. Fill out the non-display area of each frame using a color different from the color of the display area in the [Frame Edit] tab window.

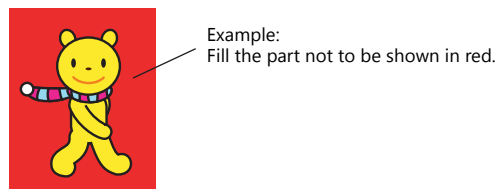

2. Click [Transparent Color Setting] on the [Edit] menu. Select the [With Transparent] checkbox and select the red color used in step 1.

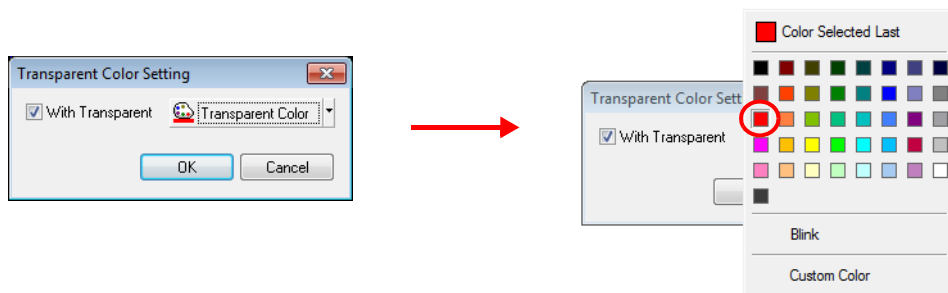

This makes the color in the non-display area transparent. When displaying the frame on the screen, the background can be seen through the non-display area.

## Structure of Layers

Animations are displayed behind overlaps on the V9 series unit.

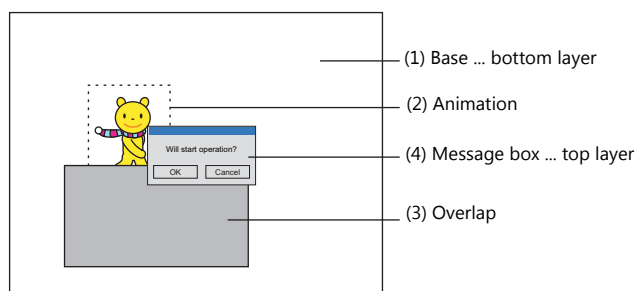

## Restrictions

- Frame size limit  
The maximum capacity per frame is 1 MB.  
In the case of capturing a bitmap or JPEG file larger than 1 MB, the file will be automatically divided into 1 MB segments so that the bitmap or JPEG can be captured. (Files with a resolution of up to 1920 × 1080 can be captured.)
- Maximum number of movements  
Up to 256 animation settings can be configured for each screen. However, the maximum number of animations that can be displayed simultaneously is 64.  
Even if the bit is set to ON, the 65th and subsequent animations will not be displayed.

# MEMO

MONITOUCH

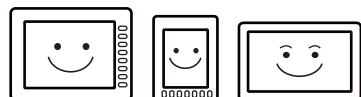

# 12 Message

---

12.1 Message Mode

12.2 Displaying Comments

## 12.1 Message Mode

### 12.1.1 Overview

This function displays messages on the screen by specifying the line number of a message previously registered in the message registration area (message editing) or by grouping these messages into blocks and specifying the block number(s). The message mode has four kinds of display configurations as shown below.

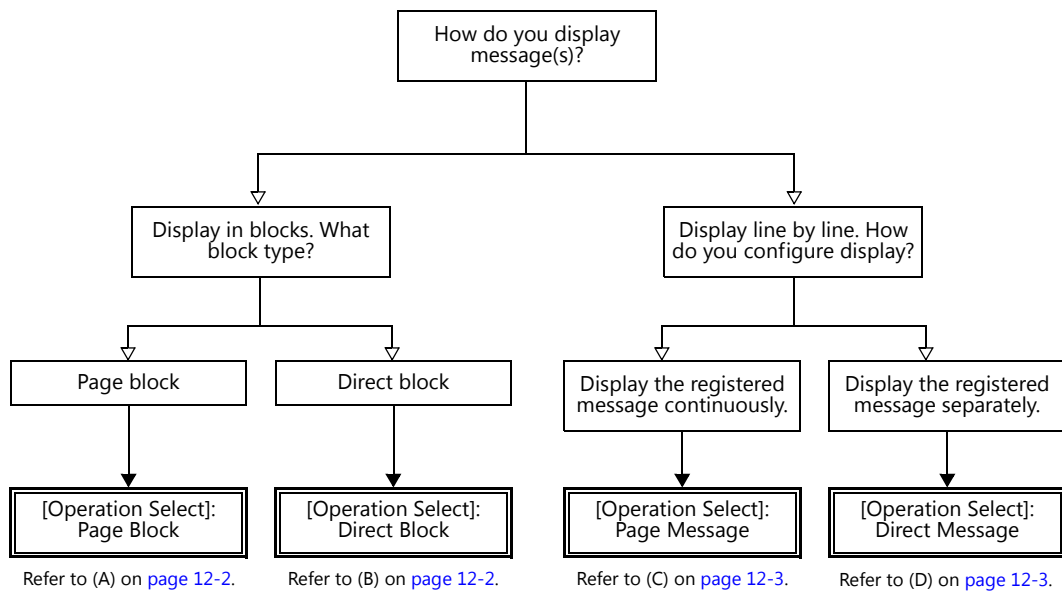

Other message display methods are described in "5.3 Message Display" page 5-28 and "8 Alarm".

## How to Specify Block Numbers

If [Operation Select] is set to [Page Block] or [Direct Block] in the message mode, specify the [Page Block] or [Direct Block] number to which the message to display is registered.

### A [Operation Select]: Page block

Register the message that was previously registered in the message editing area as [Page Block].

The corresponding "page block" is displayed on the screen.

To display a page block on the screen, there are two ways: changeover with a switch or changeover with respect to data in a device memory address.

 For setting examples, refer to "Displaying Messages (Page Blocks)" page 12-4.

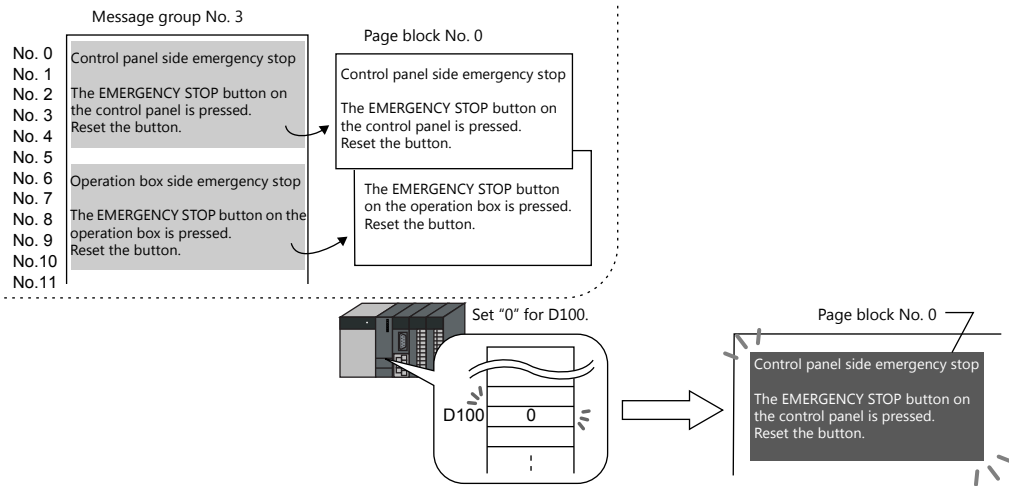

### B [Operation Select]: Direct block

Register the message that was previously registered in the message editing area as [Direct Block].

The corresponding "direct blocks" are displayed on the screen.

To display a direct block on the screen, there are two ways: changeover with a switch or changeover with respect to data in a device memory address.

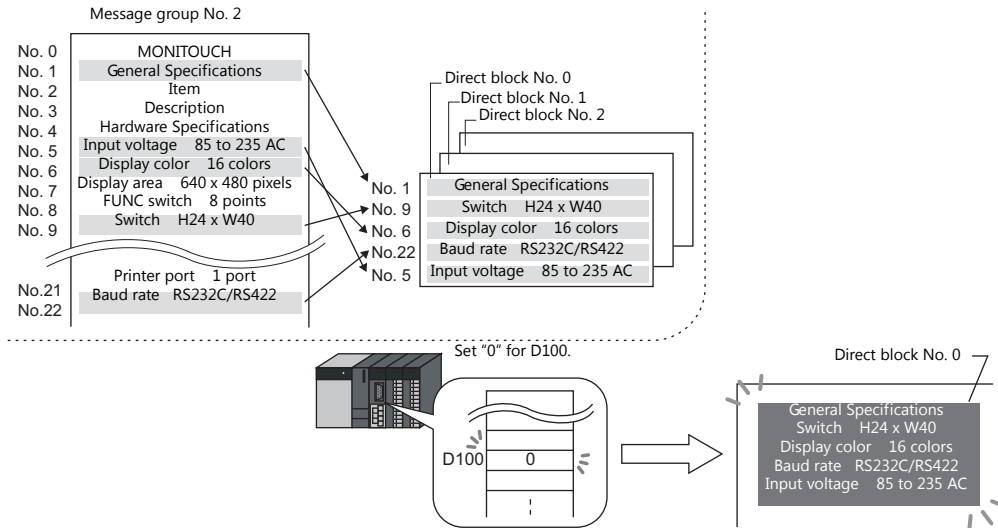



## How to Specify Message Numbers

If [Operation Select] is set to [Page Message] or [Direct Message] in the message mode, always specify the number of the message to display.

### C [Operation Select]: Page message

Specify the line number of the top message to display. Several lines of the message, of the number specified, are continuously displayed within the display area on the screen.

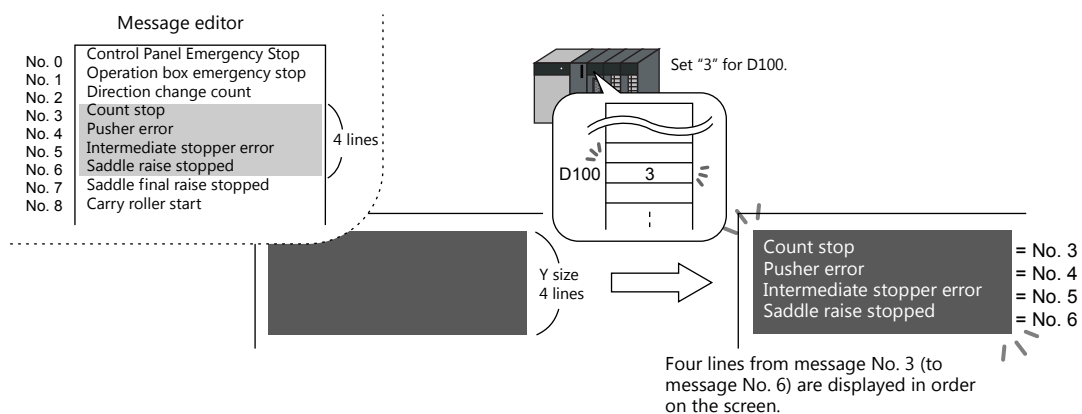

### D [Operation Select]: Direct message

One device memory address is automatically assigned to each line in the message display area. Specify the message number to display based on the assigned device memory address.

A message specified by the device memory address is displayed on the screen.

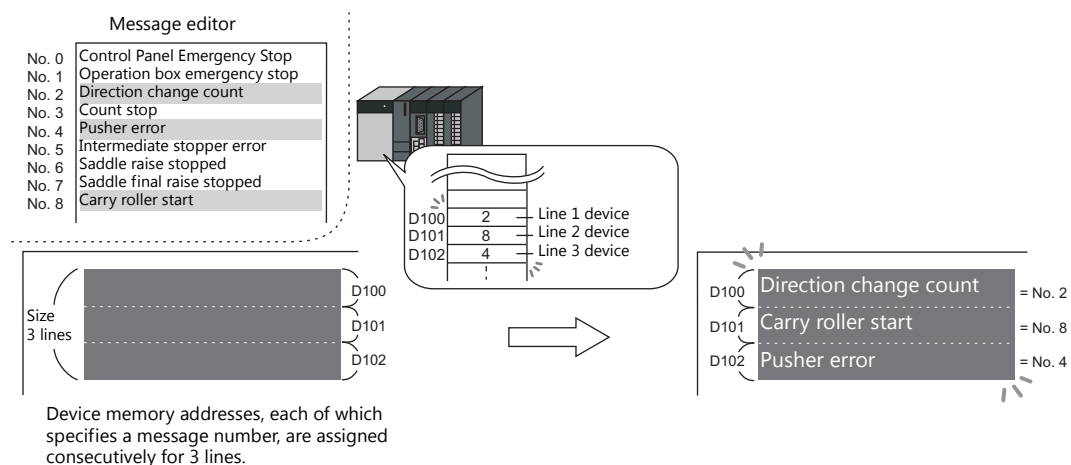

## 12.1.2 Setting Examples

### Displaying Messages (Page Blocks)

Register a message to a page block and display the message by changing the block number using a switch.

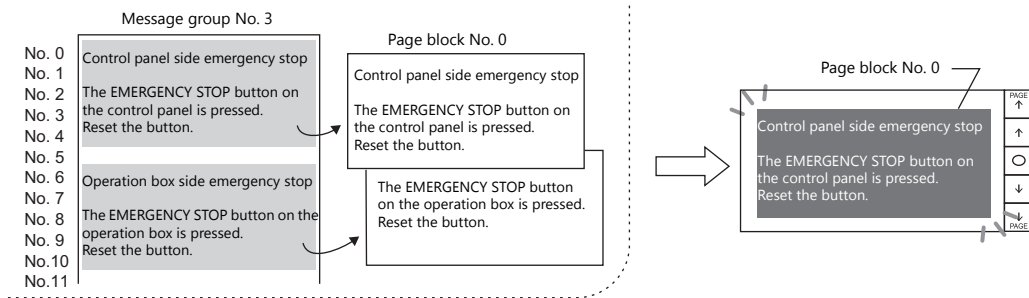

1. Click [Parts] → [Message] → [Message] and place a message mode part on the screen.

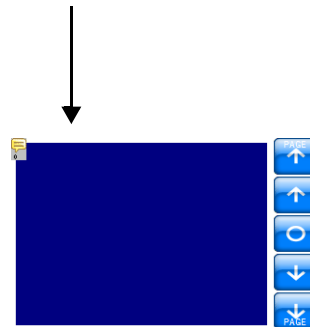
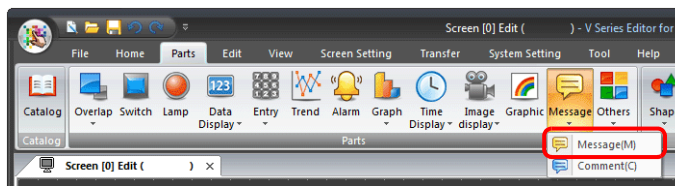

2. Double-click on the message mode part to display the settings window. Configure the [Operation Select] settings as shown below.

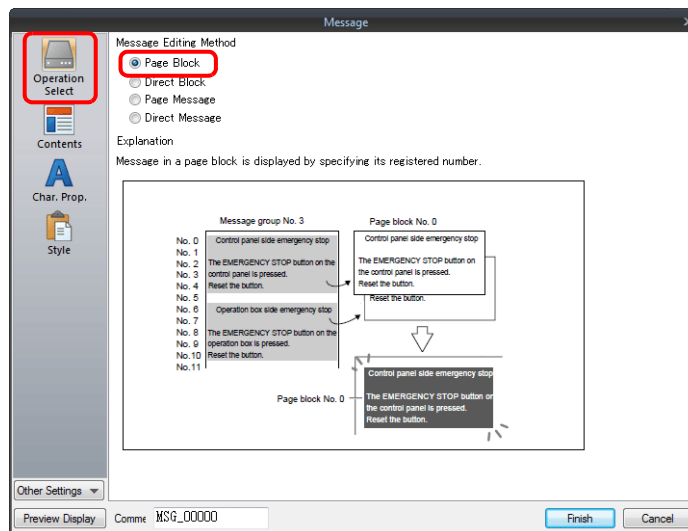

- Click [Contents] and configure the settings as shown below.  
Click [Edit] to register a message for display.

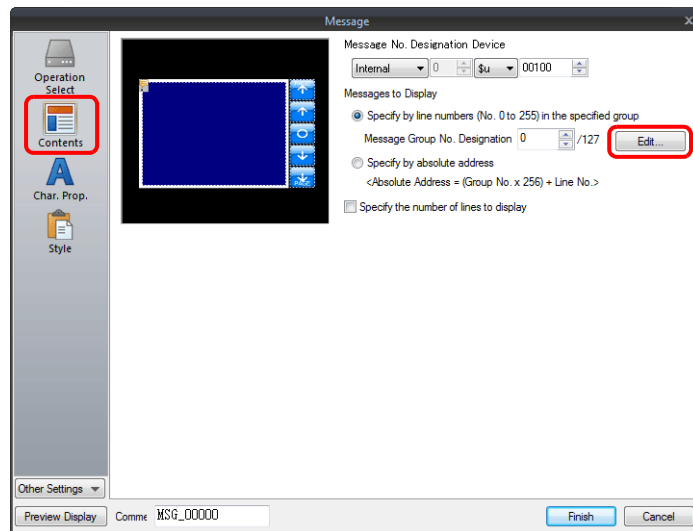

- Click [Edit] in the [Page Block Edit] window to display the [Message Edit] window.

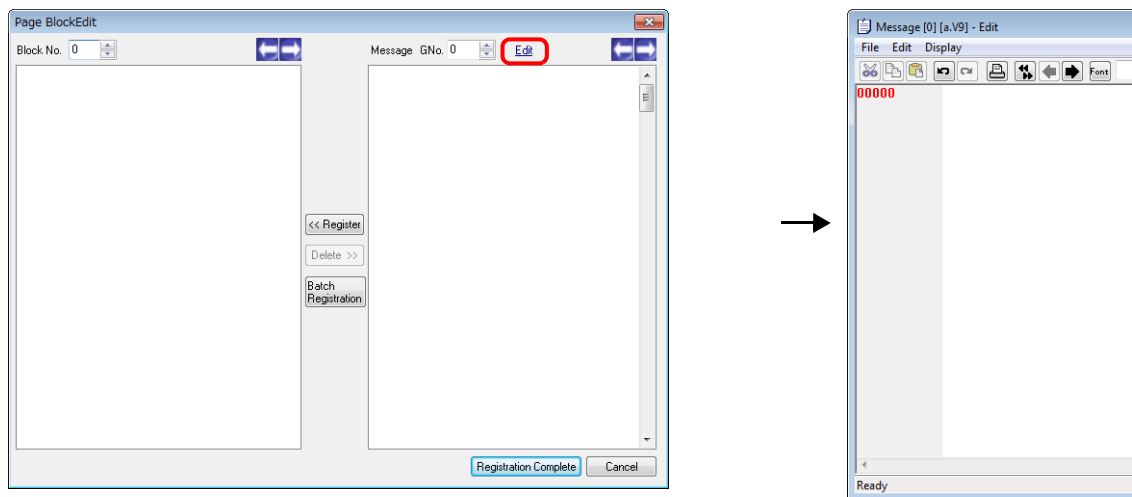

- Register the following message and then close the [Message Edit] window.

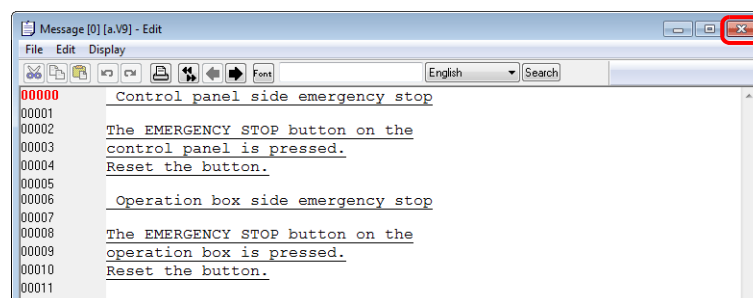

- Register the message registered in the [Message Edit] window to page block number 0 as shown below.

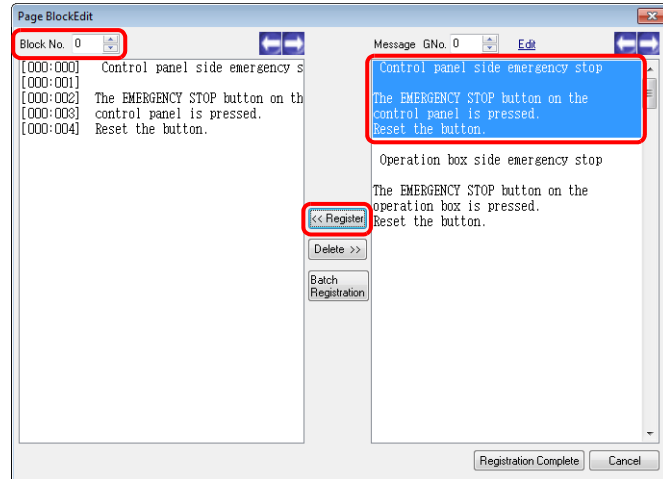

- In the same manner, register the message again to page block number 1 as shown below and click [Registration Complete].

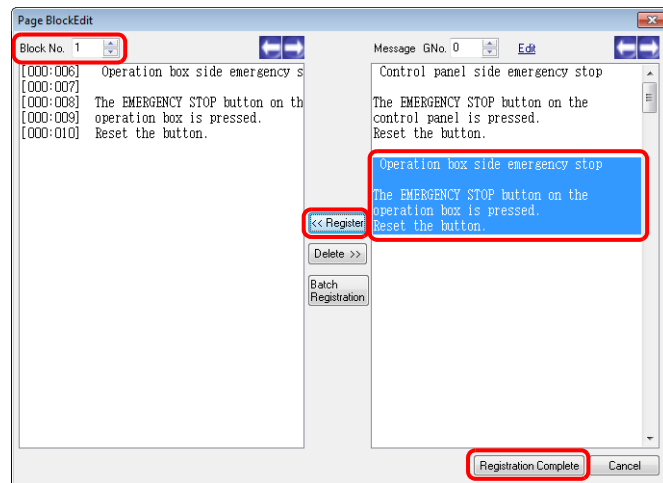

- Configure the settings as shown below and click [Finish].

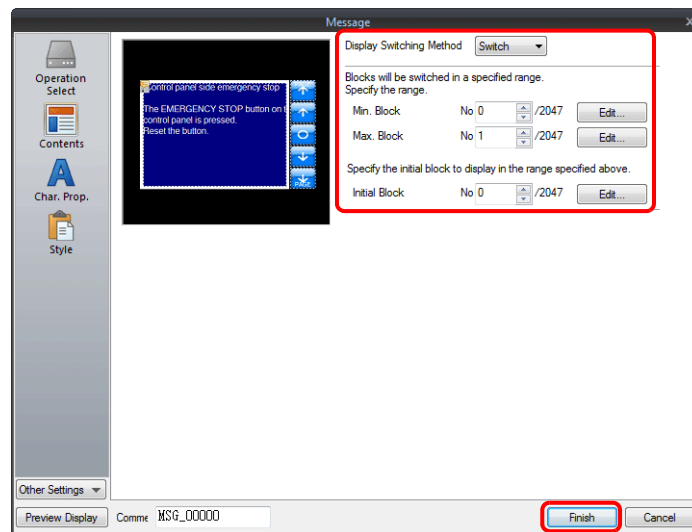

This completes the necessary settings.

## 12.1.3 Detailed Settings

### Operation Select

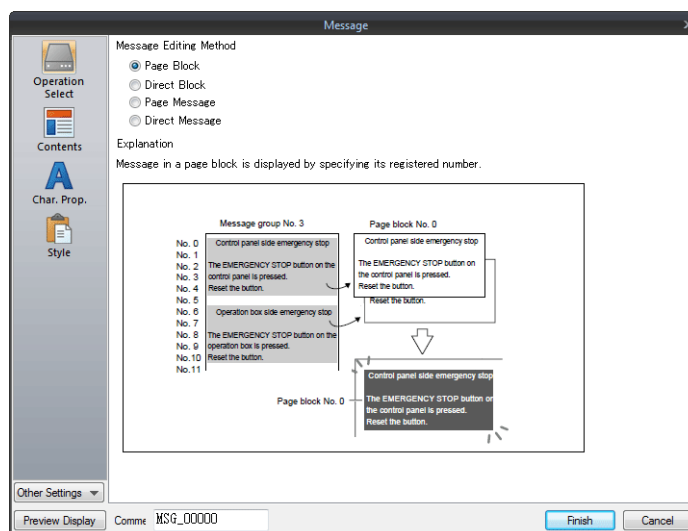

Item	Description
Message Editing Method	Select the display method for message mode.
Page Block	Page blocks are displayed on the screen. There are two methods for changing the display: switches and device memory addresses
Direct Block	Direct blocks are displayed on the screen. There are two methods for changing the display: switches and device memory addresses.
Page Message	Specify the line number of the top message to display using [Message No. Designation Device] (described later). Several lines of the message, of the number specified, are continuously displayed within the area at the top of the screen.
Direct Message	One device memory address is automatically assigned to each line in the message display area. Specify the message number to display for the assigned device memory address. A message specified by the device memory address is displayed on the screen.

## Displayed information

### [Operation Select]: Page block/direct block

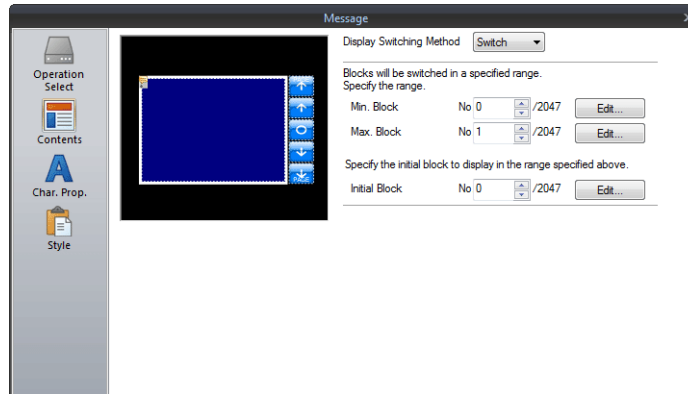

Item	Description
Display Switching Method	Select how to call up blocks.  Switch: Change the block number to display using a switch placed on the screen.  Device: Directly specify the block number using [Block No. Setting Device] (described later) to display the corresponding block.
Min. Block	Set the lowest block number for the page blocks or direct blocks to display. The page block or direct block can be edited by clicking [Edit].
Max. Block	Set the highest block number for the page blocks or direct blocks to display. The page block or direct block can be edited by clicking [Edit].
Initial Block	Set the initial block number to show when the screen is displayed. The page block or direct block can be edited by clicking [Edit].
Block No. Setting Device	Specify the block number to display on the screen. The page block or direct block can be edited by clicking [Block Edit].

### [Operation Select]: Page message/direct message

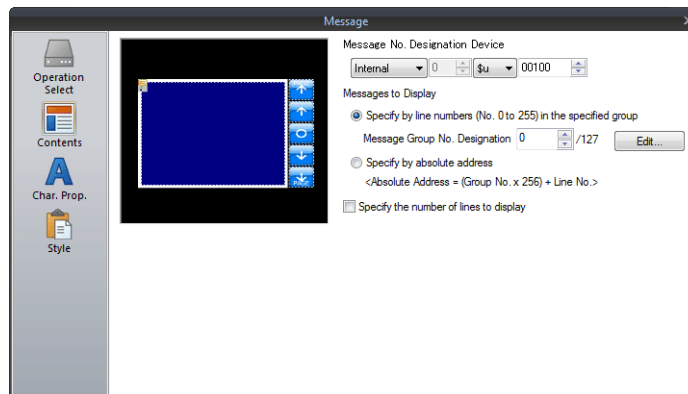

Item	Description
Message No. Designation Device	Specify the message number to display on the screen.  One device memory address is automatically assigned to each line for direct messages. Device memory addresses are allocated sequentially from the first device memory address specified for [Message No. Designation Device]. The number of words to use is based on the display area's Y size divided by the character enlargement factor value.
Messages to Display	Specify by line numbers (No. 0 to 255) in the specified group Set a group number. The message displayed on the screen is limited to a message within the specified group number. Specify a message number (0 to 255) in a single group for [Message No. Designation Device].
	Specify by absolute address Specify the message number to be displayed as an absolute address. Messages from more than one group can be specified. Specify a message number (0 to 32767) among all groups for [Message No. Designation Device].
Specify the number of lines to display	Select this checkbox to specify the number of lines of the message to display.

## Char. Prop.

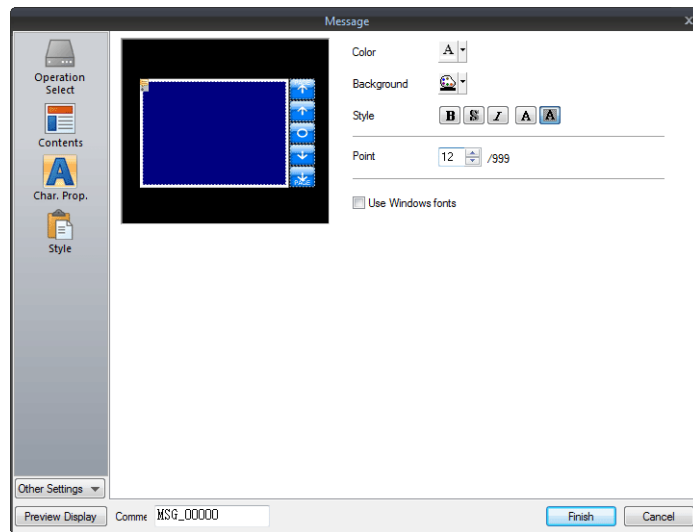

Item	Description
Color	Set the message color.
Background	Set the background color.
Style	Set the message style.
Character Size (1 - 8)	Set the character enlargement factor value of the message. When [Switch] or [Lamp] is selected for [Others] → [Action Area] (described later), the enlargement factor values for X and Y are fixed to "1".
Point (6 - 999)	Set the text size. When [Switch] or [Lamp] is selected for [Others] → [Action Area] (described later), the point size is fixed to "12".
Use Windows fonts	Select this checkbox to use a Windows font. Message character properties are configured in the [Message Edit] window.

## Style

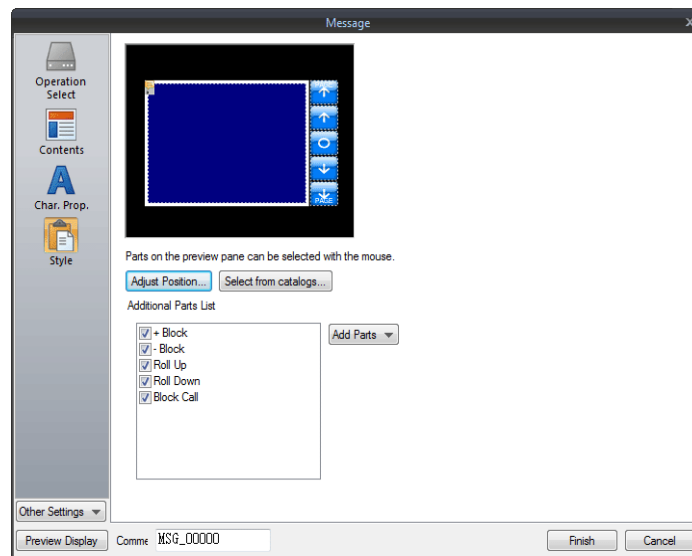

Item	Description
Adjust Position	Adjust the position and size of parts.
Select from catalogs	Select the part design.
Additional Parts List	Add and delete switch parts used in message mode. Each switch is used for page blocks or direct blocks.
+ Block	Changes to the next message block.
- Block	Changes to the previous message block.
Roll Up	Scrolls up through messages.
Roll Down	Scrolls down through messages.
Block Call	Changes to the specified block number.



## Editing parts

Select a part in the preview pane to change the part's style settings.

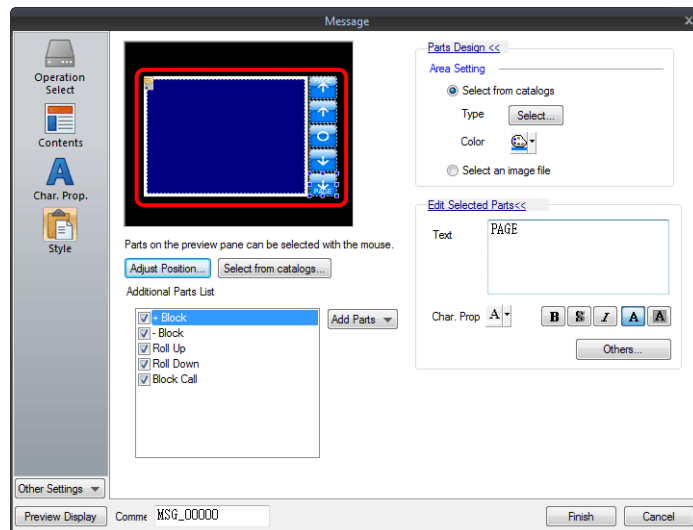

Item		Description
Parts Design	Area Setting	Select from catalogs Select the part design. After selecting the part, select the part color.
		Select an image file Select a PNG file.
Edit Selected Parts	Text	Enter the text to be displayed on the switch. (Up to 4 lines can be registered. Text properties can be set for each line.) Text can be justified within the switch part.
	Char. Prop.	Set the text properties and style.
	Others	Edit switch settings other than those related to text and style. For details on switch settings, refer to <a href="#">"3.1 Switch" page 3-1.</a>

## Checking the display area size

Whether messages are displayed as intended in display areas can be checked on the screen.

With messages registered, click [View] → [Display Environment] → [Display] tab and select the [Display Message] checkbox.

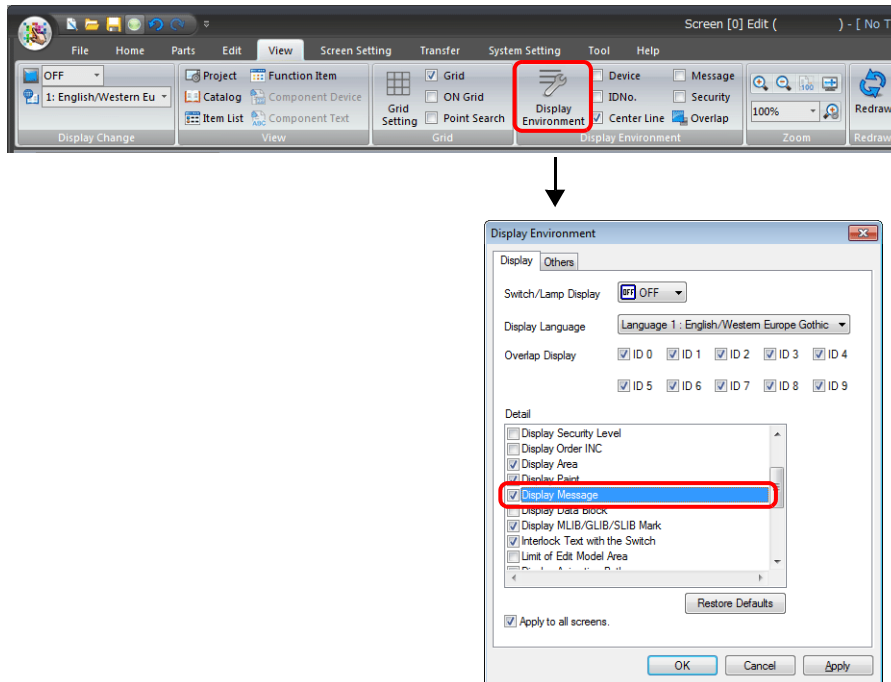

The registered messages are displayed on the screen.

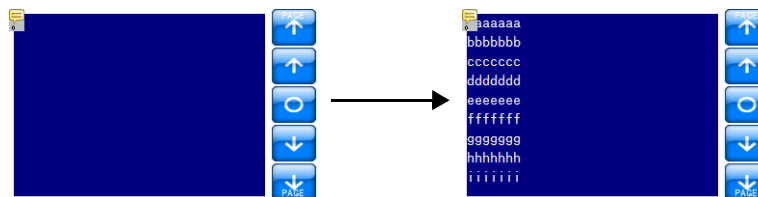

To adjust the size and other settings, perform adjustments via the [Adjust Position] button described in "Style" page 12-10.

## Show/Hide

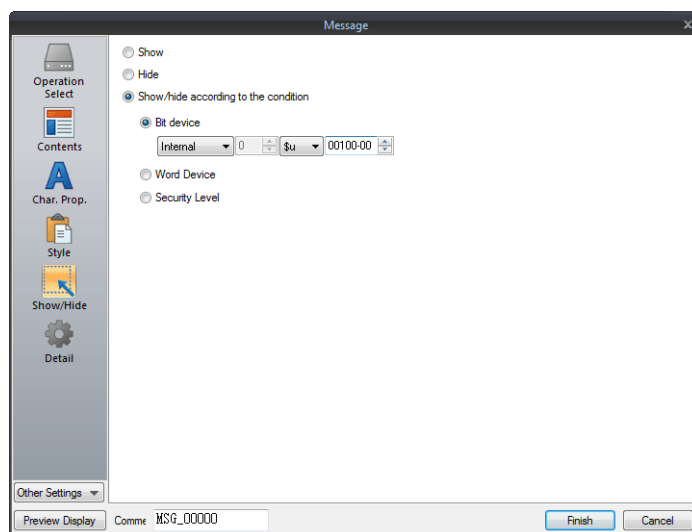

Item		Description			
Show		Display the message mode part on the screen.			
Hide		Do not display the message mode part on the screen.			
Show/Hide according to the condition	Bit device	Display the message mode part if the device memory bit is ON and hide the message mode part if the device memory bit is OFF.			
	Word Device	Show the message mode part if the condition is satisfied and hide the message mode part if the condition is not satisfied.			
		<table border="1"> <tr> <td>Constant Display Type</td> <td>Select the data type of the conditional expression. [DEC+ -]/[DEC]/[BCD]</td> </tr> <tr> <td>Condition expression</td> <td>Set an equal sign, value, and device memory address as the conditions for comparison.</td> </tr> </table>	Constant Display Type	Select the data type of the conditional expression. [DEC+ -]/[DEC]/[BCD]	Condition expression
	Constant Display Type	Select the data type of the conditional expression. [DEC+ -]/[DEC]/[BCD]			
Condition expression	Set an equal sign, value, and device memory address as the conditions for comparison.				
Security Level	This setting is available when using the security function. The "show/Hide" attribute can be controlled according to the user's login level. For details, refer to "5 Security" in the V9 Series Reference Manual 2.				

## Detail

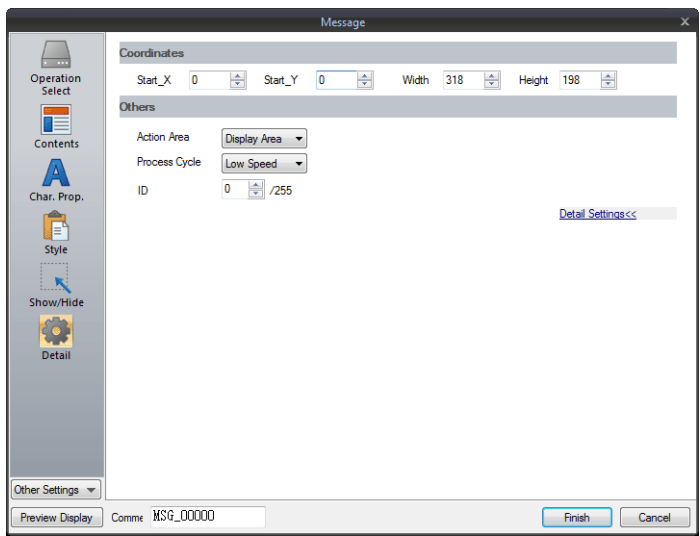

Item		Description
Coordinates	Start X/Start Y	Set the display position of the message mode part using X and Y coordinates.
	Width/Height	Set the size of the message mode part by specifying width and height.
Others	Action Area	<p>Set the position to display the message on the screen.</p> <p>Display area: Display on provided display area parts.</p> <p>Switch: Display on provided switch parts. Switches are automatically set to "Mode" for [Function]. Each switch has [Display Order] (0 to 23) as an auxiliary setting where the message to display on each switch can be specified. When [Display Order] settings are all the same, messages are displayed in the same order that switches were placed. * <b>One switch part shows one message line.</b></p> <p>Lamp: Display on provided lamp parts. Lamps are automatically set to "Mode" for [Function]. As with switch parts, each lamp has [Display Order] (0 to 23) as an auxiliary setting. * <b>One lamp part shows one message line.</b></p>
	Process Cycle	Set a cycle for the V9 series to read PLC data while the V9 series is communicating with the PLC. For details, refer to " <a href="#">1.2 Process Cycle</a> ".
	ID (0 - 255)	Set the ID. For details on IDs, refer to the V9 Series Operation Manual.

## 12.1.4 Registering Messages

There are two ways of registering messages.

- [Message] settings window → [Contents] → [Edit]

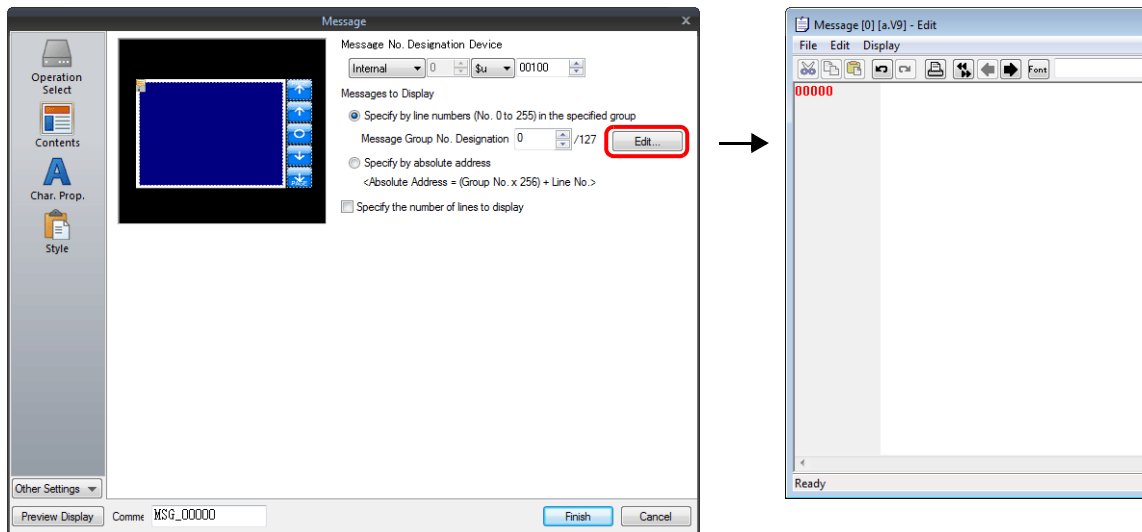

- \* When [Operation Select] is set to [Page Block] or [Direct Block], the [Message Edit] window cannot be displayed using this method.
- \* When a message group number is specified, the cursor appears at the start line of the group.

- [Home] → [Registration Item] → [Message] → (specify group number)

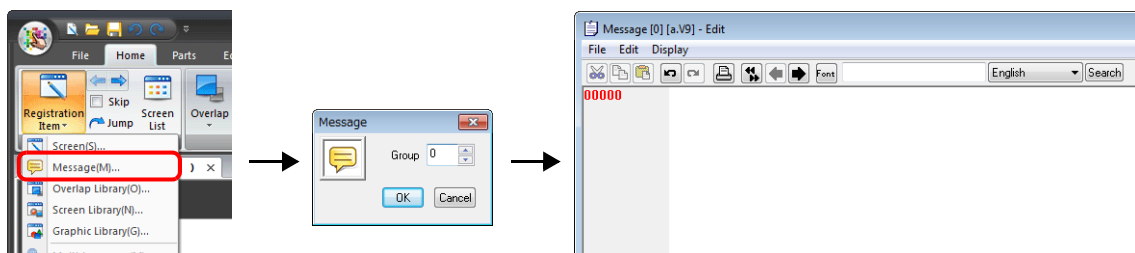

In the [Message Edit] window, line numbers denote absolute addresses as default.

When a message group number is specified, deselect [Display] menu → [Display Absolute Address as Line Number] before commencing editing.

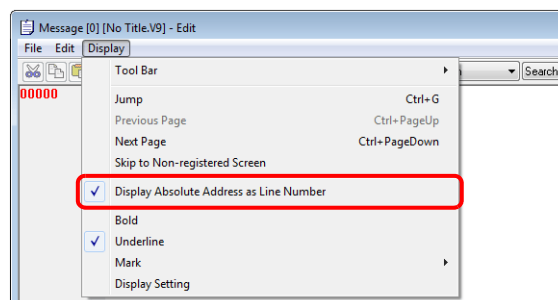

For details on the editing procedure in the [Message Edit] window, refer to the V9 Series Operation Manual.

## 12.1.5 Registering Page Blocks

There are two ways of registering page blocks.

- [Message] settings window → [Contents] → [Edit]

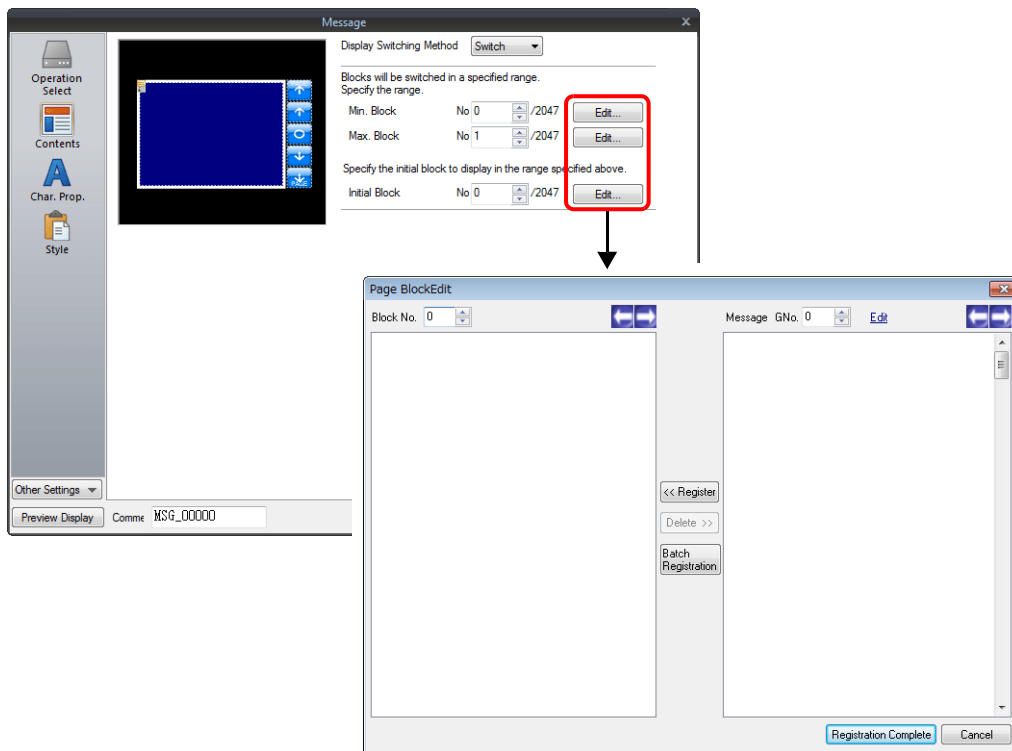

- [Home] → [Registration Item] → [Page Block] → (specify block number)

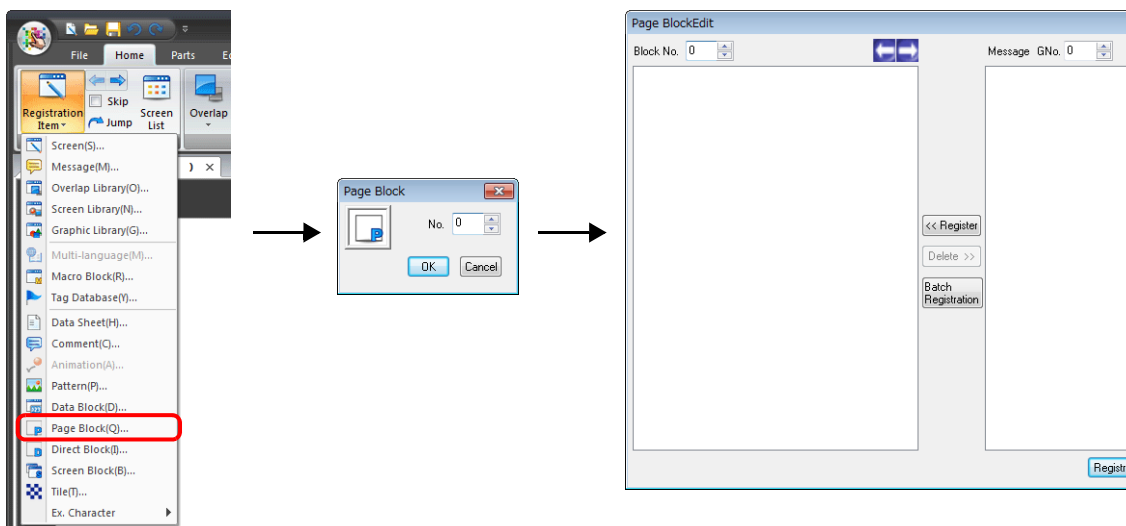

For details on the editing procedure in the [Page Block Edit] window, refer to the V9 Series Operation Manual.

## 12.1.6 Registering Direct Blocks

There are two ways of registering direct blocks.

- [Message] settings window → [Contents] → [Edit]

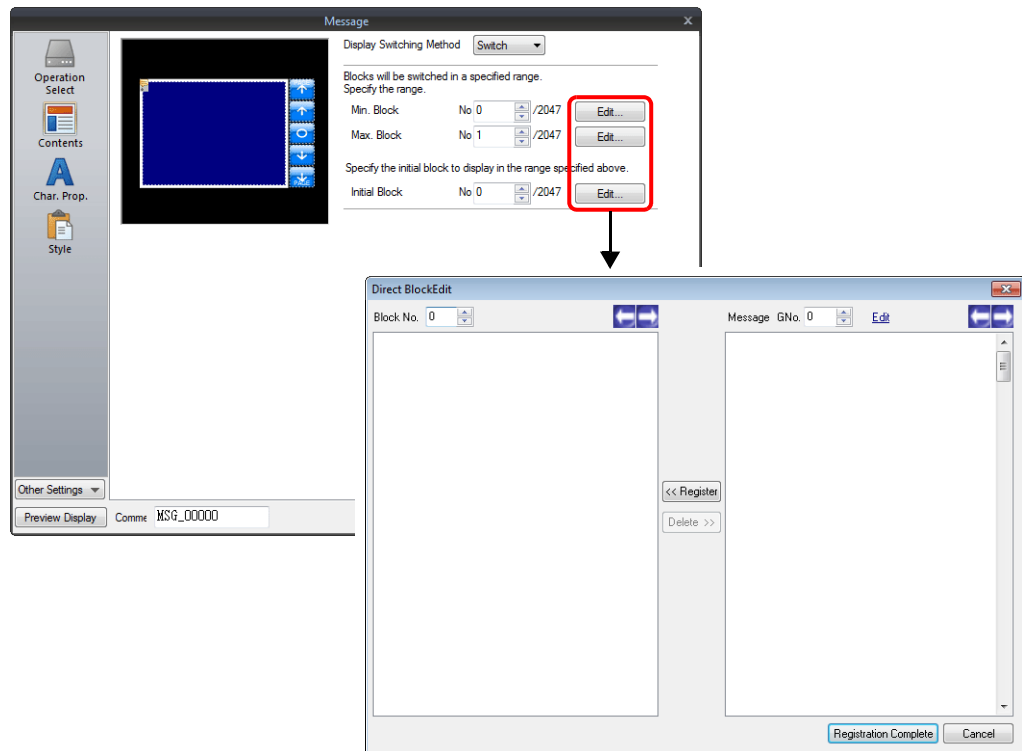

- [Home] → [Registration Item] → [Direct Block] → (specify block number)

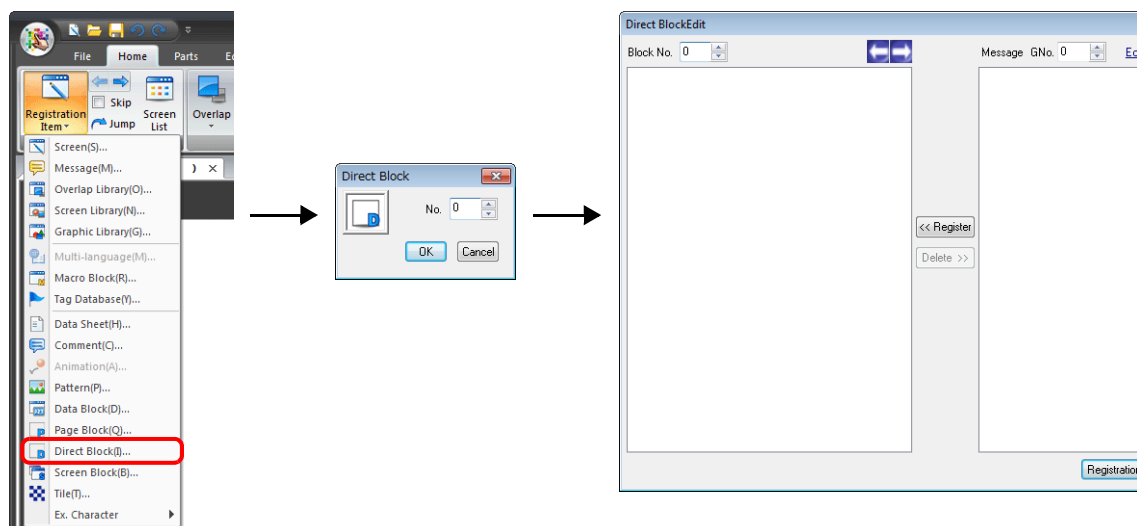

For details on the editing procedure in the [Direct Block Edit] window, refer to the V9 Series Operation Manual.

## 12.2 Displaying Comments

### 12.2.1 Overview

Register comments in advance and display them using bit designation or number designation. A maximum of 32,767 comments can be registered. Character properties, such as color or size, can be set for each comment. One comment can include multiple lines.

#### Bit Designation

Display the comment that corresponds to bit ON of the assigned device memory address.

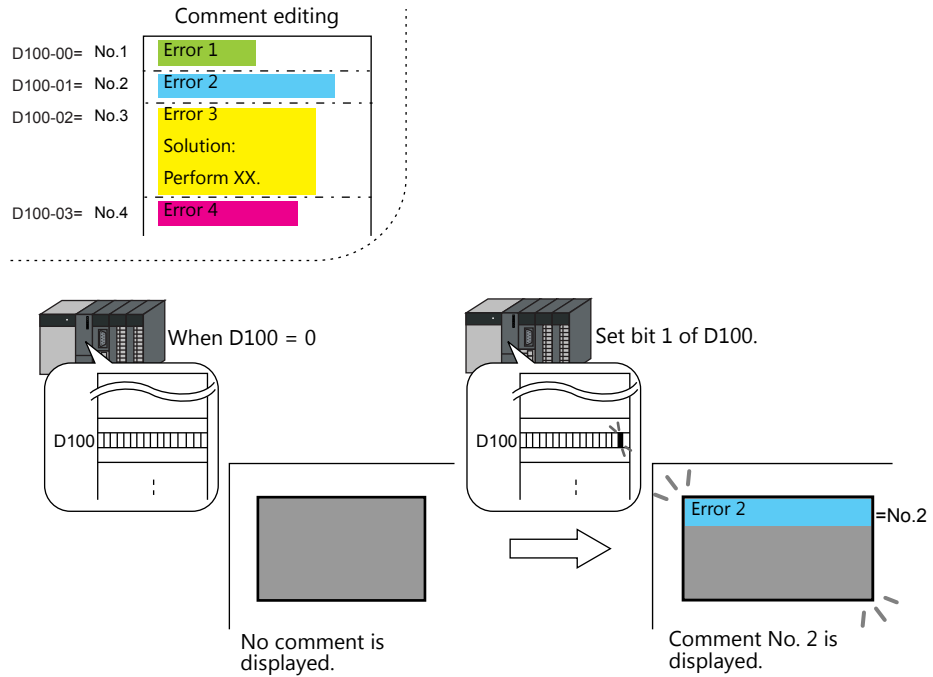

When multiple bits are set to ON, the least significant bit has priority.

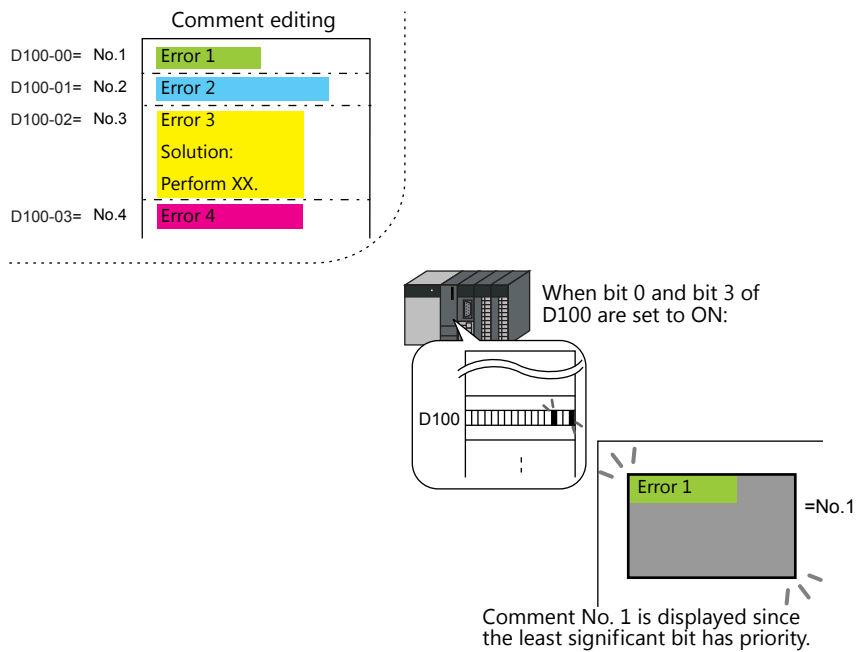



### Number Designation

Set the comment number to the assigned device memory address and display the comment.

☞ For setting examples, refer to "Displaying Comments (Number Designation)" page 12-20.

Comment editing

No.1	Error 1
No.2	Error 2
No.3	Error 3 Solution: Perform XX.
No.4	Error 4

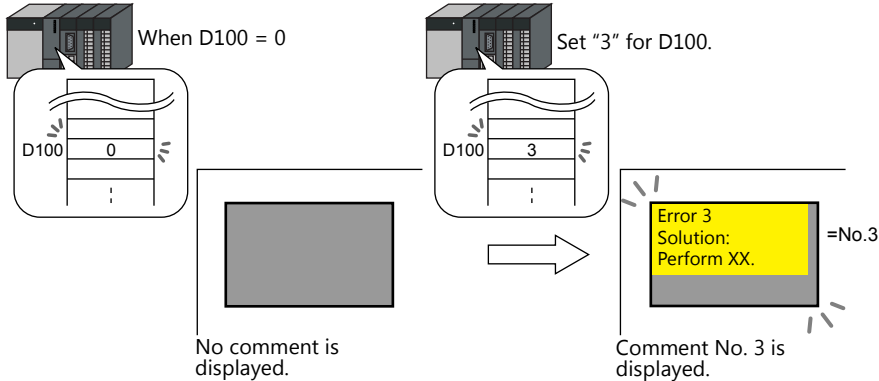

## 12.2.2 Setting Examples

### Displaying Comments (Number Designation)

Register the comment to display in advance and specify the comment number to D100.

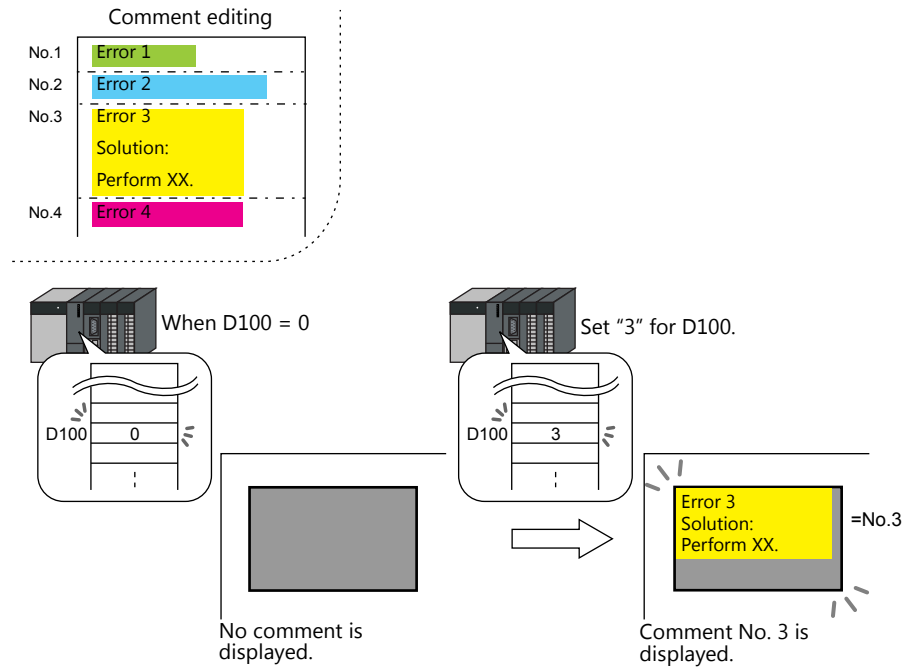

1. Click [Parts] → [Message] → [Comment] and place a comment display on the screen.

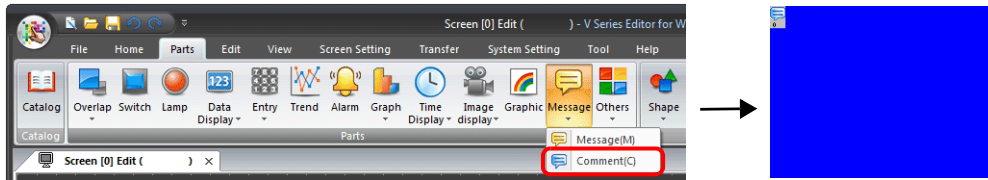

2. Double-click on the comment display to display the settings window. Configure the following settings for [Contents] and then click [Finish].

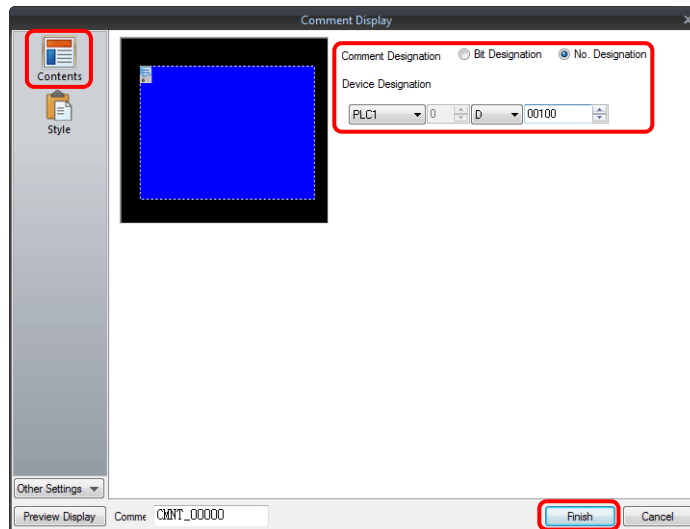

- Click [Home] → [Registration Item] → [Comment] → [OK] with group number 0.

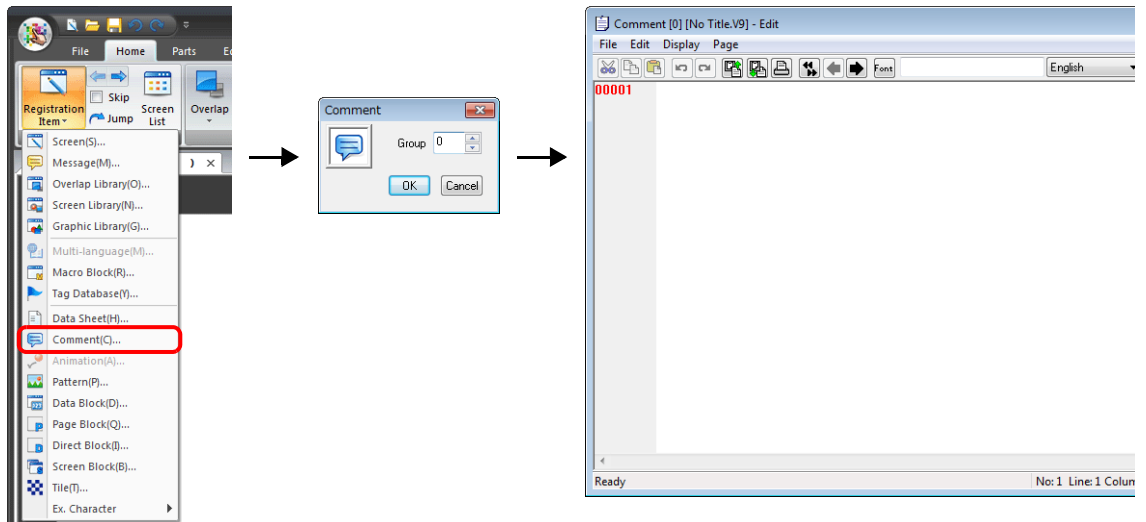

- Register a comment as shown below.  
Press the [Alt] and [Enter] keys together to enter a new line.

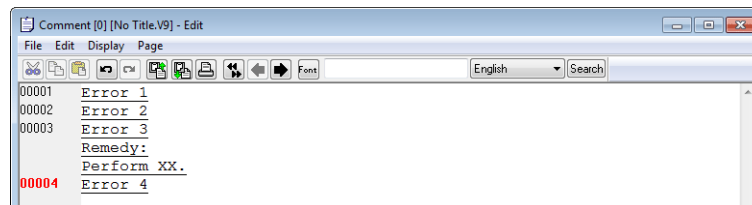

- Select the comment line for setting character properties, right-click, and click [Char. Prop.].  
Set the following character properties and then close the [Comment Edit] window.

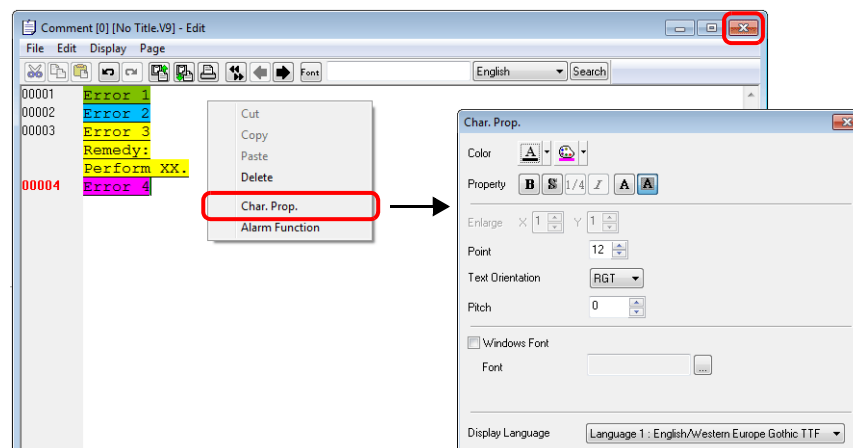

This completes the necessary settings.

## 12.2.3 Detailed Settings

### Operation Select

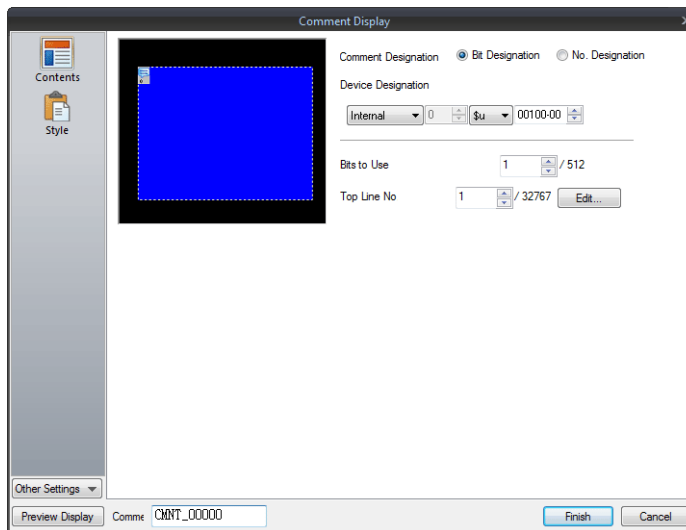

Item	Description
Comment Designation	Select the comment display method. Bit Designation Select this option to display the comment using bit activation. No. Designation Select this option to display the comment by specifying the comment number.
Device Designation	Specify the command device memory address to use for displaying comments on the screen. The setting should vary depending on which of [Bit Designation] or [No. Designation] was selected. Bit Designation: Set the device memory address (1 bit) to display the comment set for [Top Line No.]. When multiple bits are set to ON, the least significant bit has priority. No. Designation: Set the device memory address (1 word) for specifying the comment number. When "0" is specified, no comment is displayed. When "1 to 32767" is specified, the corresponding comment is displayed. However, if the BCD code is used on the PLC, the available range is limited to "0 to 9999".
Bits to Use (1 - 512)	Set the number of bits to use for comment display (total number of comments to be displayed). From the bit set for [Device Designation], as many bits as set for [Bits to Use] are consecutively allocated to the comment specified for [Top Line No.] and later.
Top Line No. (1 - 32767)	Specify the top comment number for display by activation of the bit set for [Device Designation]. Click [Edit] to display the [Comment Edit] window.

Style

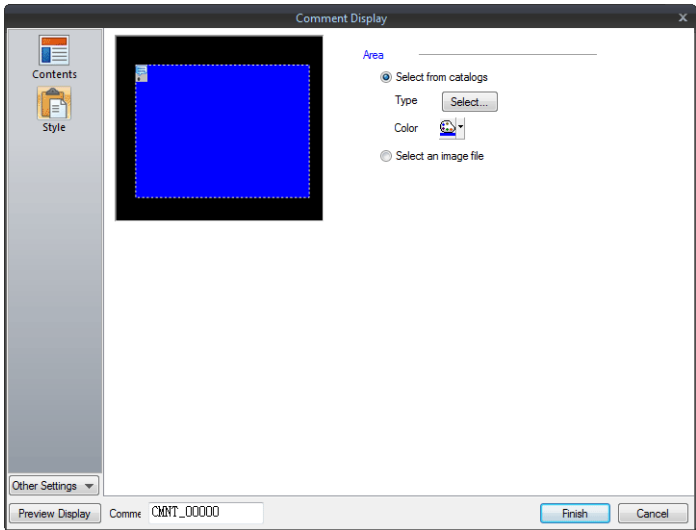

Item		Description
Area	Select from catalogs	Select the part design. After selecting the part, select the part color.
	Select an image file	Select a PNG file.

Show/Hide

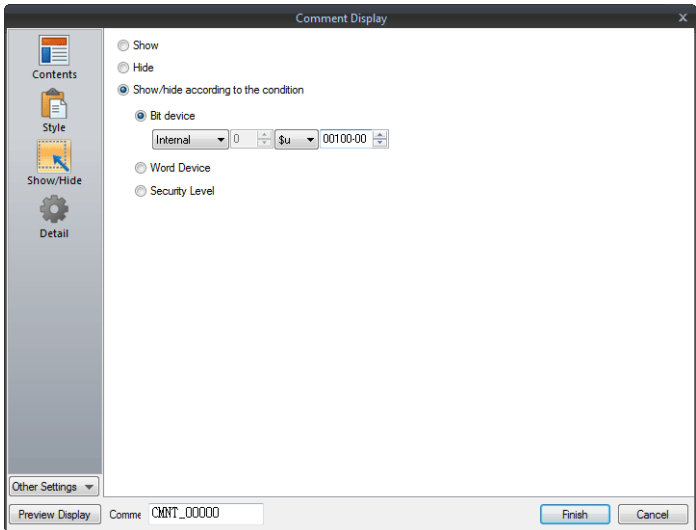

Item		Description	
Show		Display the message mode part on the screen.	
Hide		Do not display the message mode part on the screen.	
Show/hide according to the condition	Bit device	Display the message mode part if the device memory bit is ON and hide the message mode part if the device memory bit is OFF.	
	Word Device	Show the message mode part if the condition is satisfied and hide the message mode part if the condition is not satisfied.	
		Constant Display Type	Select the data type of the conditional expression. [DEC+ -]/[DEC]/[BCD]
		Condition expression	Set an equal sign, value, and device memory address as the conditions for comparison.
Security Level		This setting is available when using the security function. The "show/hide" attribute can be controlled according to the user's login level. For details, refer to "5 Security" in the V9 Series Reference Manual 2.	

## Detail

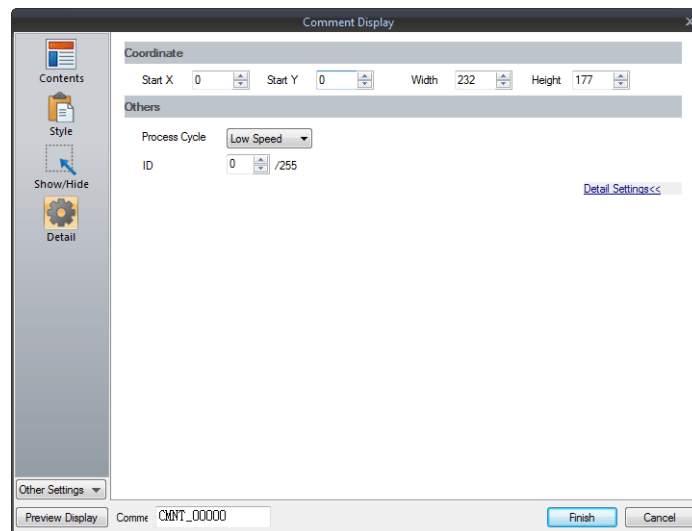

Item		Description
Coordinates	Start X/Start Y	Set the display position of the comment display using X and Y coordinates.
	Width/Height	Set the size of the comment display by specifying width and height.
Others	Process Cycle	Set a cycle for the V9 series to read PLC data while the V9 series is communicating with the PLC. For details, refer to <a href="#">"1.2 Process Cycle"</a> .
	ID (0 - 255)	Set the ID. For details on IDs, refer to the V9 Series Operation Manual.

### Checking the display area size

Whether comments are displayed as intended in display areas can be checked on the screen. The procedure is the same as described for the message mode. Refer to [page 12-12](#).

## 12.2.4 Registering Comments

There are two ways of registering comments.

- [Comment] settings window → [Contents] → [Edit]

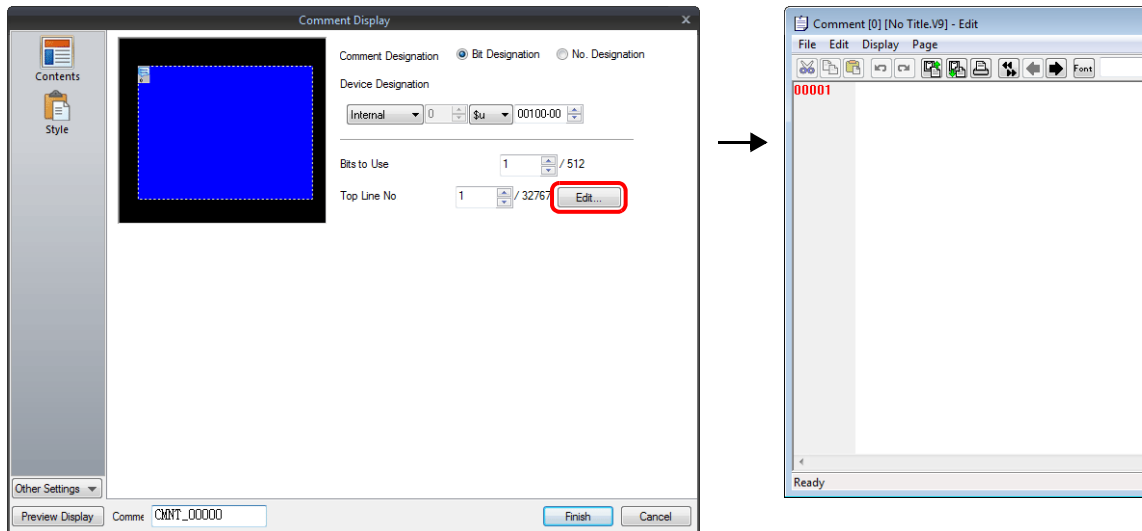

- \* When [No. Designation] is selected, the window for comment registration will not be displayed in this way.
- \* The cursor is displayed at the start line of the group that includes the line number specified for [Top Line No.].

- [Home] → [Registration Item] → [Comment] → (specify group number)

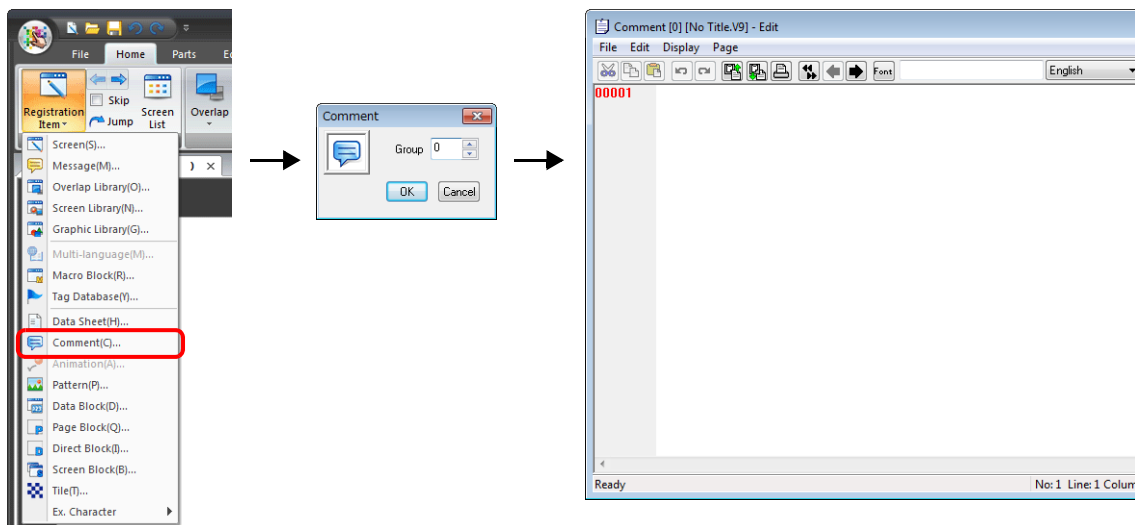

For details on the editing procedure in the [Comment Edit] window, refer to the V9 Series Operation Manual.

# MEMO

MONITOUCH





## **13 Others**

---

### 13.1 Memo Pad

## 13.1 Memo Pad

### 13.1.1 Overview

- Message board function  
The message board function is available for leaving daily messages in a workshop, etc. This is particularly useful for exchanging messages among operators working in shifts.
- Pen input  
Message entry is made simple by writing on the screen directly with a special pen.
- A maximum of eight memo pad areas  
Memo pad areas are common to every screen. Up to 8 memo pad areas can be registered.
- Saved in the SRAM area  
When a memo pad area is secured in the built-in or separate SRAM area, the data is retained even after the power is turned off.
- Also, it is possible to use a storage device to save memo pad data without using the SRAM area.

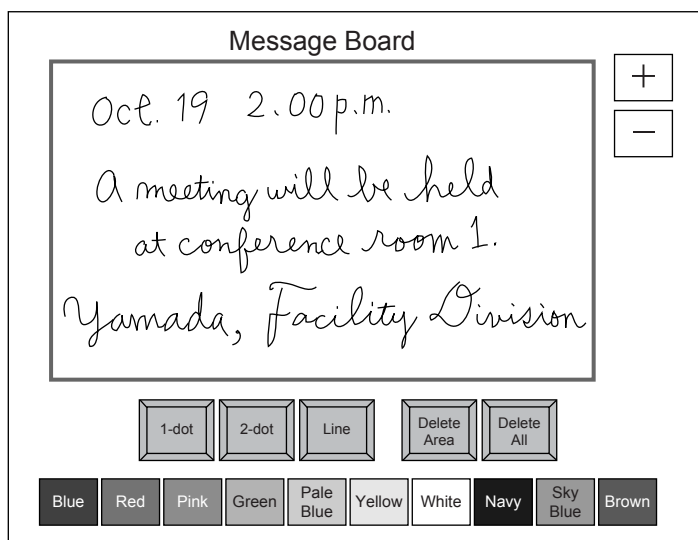

Only one memo pad function can be used on one screen.

## 13.1.2 Usage Example

Suppose that the following screen is created.

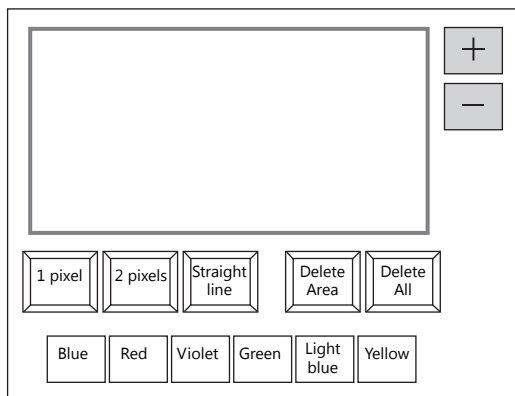

- When the screen is first opened, the following settings are set as default.
  - Pen size: 1 pixel
  - Pen color: White
  - Pen state: Free
 To change the setting, press the corresponding switch and set the desired option.
- Write a message within the memo pad area.

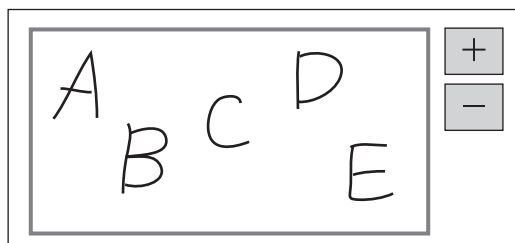

Use the dedicated pen when writing messages.

- When deleting the message, press the [Delete All] switch.
- When deleting part of the message, press the [Delete Area] switch (ON display), and enclose the desired data. The enclosed data is deleted. On completion, press the [Delete Area] switch (OFF display).
- When drawing a straight line, press the [Line] switch (ON display). Moving the pen on the memo pad area draws a straight line. To cancel the function that draws straight lines, press the [Line] switch again (OFF display).
- Pressing the [+] switch brings up a new memo pad area (up to 8 areas). Pressing the [-] switch brings up the previous memo pad area.

## 13.1.3 Detailed Settings

### Style

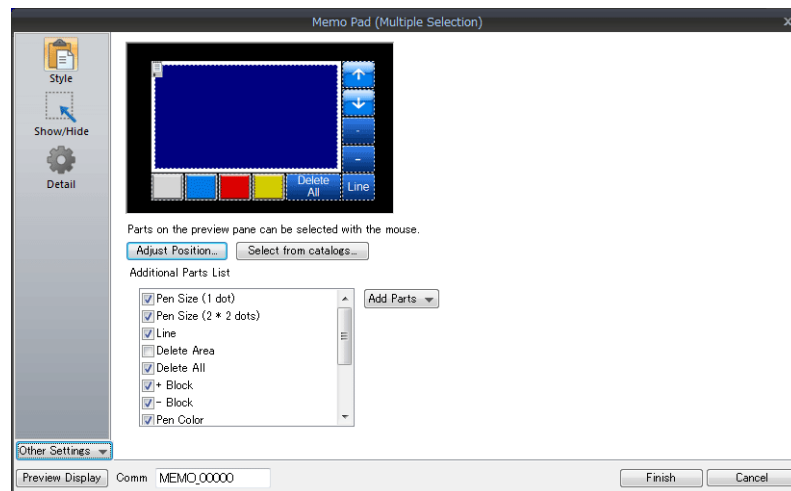

	Item	Description
Additional Parts List	Pen Size (1 dot)	Add a [Pen Size (1 dot)] switch. Selects the pen thickness.
	Pen Size (2 × 2 dots)	Add a [Pen Size (2 × 2 dots)] switch. Selects the pen thickness.
	Line	Add a [Line] switch. Select the pen state. This is an alternate switch. ON: Line OFF: Free
	Delete Area	Add a [Delete Area] switch. This switch deletes the selected memo pad area. This is an alternate switch. ON: Delete the rectangular area selected on the display area. OFF: Deletion is not possible.
	Delete All	Add a [Delete All] switch. This switch deletes data from the displayed memo pad area.
	+ Block	Add a [+ Block] switch. Brings up the next memo pad area (up to 8).
	– Block	Add a [– Block] switch. Brings up the previous memo pad area (up to 8).
	Pen Color	Add a [Pen Color] switch. This switch is used to select the pen color.
	Block Call	Add a [Block Call] switch. Brings up the memo pad area of the specified number.
Add Parts	Switch	Add a switch.

## Detail

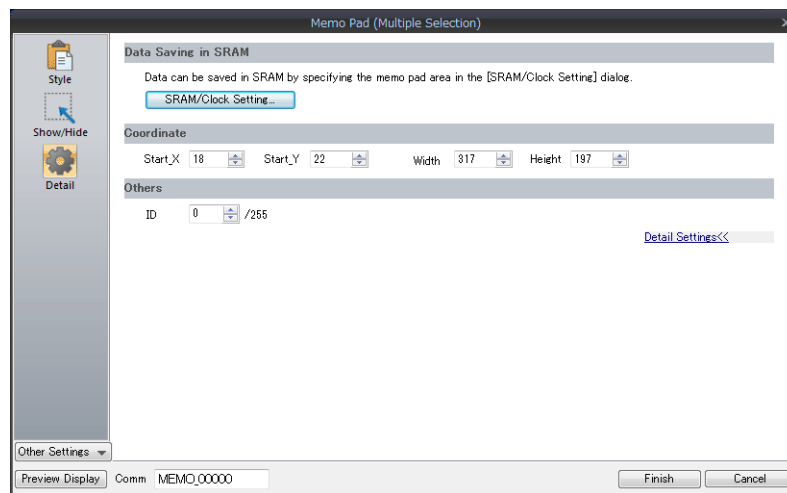

Item	Description
SRAM/Clock Setting	Configure the settings to save memo pad data to the SRAM area. For details, refer to <a href="#">"13.1.4 Memo Pad Data Storage"</a> page 13-5.
Coordinate	Set the Start X/Start Y (top left coordinates).
ID	Set the ID.

## 13.1.4 Memo Pad Data Storage

Memo pad data can be saved to the built-in RAM, SRAM, or a storage device. Data saved to RAM is cleared when MONITOUCH is turned off or when the local mode screen is displayed. To retain data even when the power is turned off, save data to SRAM or a storage device.

### Memo Pad Storage Area Size

Storage Target	Capacity (Words)
RAM	32,000
SRAM *	262,000
Storage device	262,000

\* This is the maximum capacity available provided that the entire SRAM area is used for the memo pad function.

 For details of the procedure for dividing the SRAM area, etc., refer to "1.1 System Settings".

### Saving to RAM

No settings are required.

### Saving to SRAM

To save data to the SRAM area, settings must be configured in the [SRAM/Clock Setting] window.

#### [SRAM/Clock Setting] window

- Storage area for memo pad  
Set the storage area size for the memo pad function in the SRAM area.  
Refer to the list shown above to set an appropriate size.

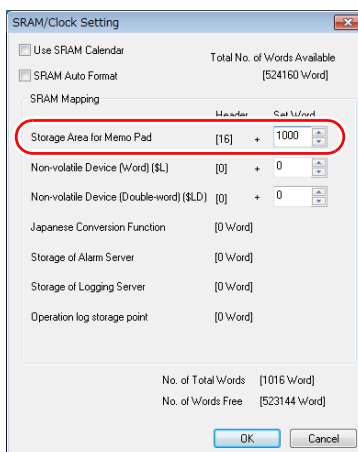

 For details on other settings, refer to "1.1 System Settings".

### Saving to a Storage Device

No settings are required. Insert the storage device into MONITOUCH.

Note that when the memo pad area is configured in the [SRAM/Clock Setting] window, data is stored in the SRAM area even if a storage device is inserted.

- Filename: MEMxxxx.png (xxxx=0000 to 0007)

## Timing for Saving Data

The memo pad data is saved to the memo pad area at the following timing.

- When switching pages using the [Function: + Block, – Block] switches
- When changing the screen
- When switching from RUN mode to Local mode (only for SRAM)

If data cannot be saved due to insufficient memory, the memo pad display area flashes and the unit beeps. Reduce the memo pad data.

The remaining space of the memo pad data storage area is stored in the system memory addresses \$s108 and 109.

**\* Notes on SRAM usage**

- If the power is shut down before data is saved, the data is lost.
- If the power is shut down while data is being saved, all the data may be lost.  
The data save status is stored in the system memory address \$s720.

## System Memory

Memo pad data is stored in system memory \$s.

Address (\$s)	Description	Device Type
106	Memo pad number (0 to 7)	
107	<p>0: Data not registered 1: Data registered</p>	← V Data is written from the V9 series unit.
108 109	Remaining space of memo pad data storage area (unit: bytes)	
720	Result of SRAM area save 0: Successfully saved 1: Error in data. The previous data is cleared.	
727	0: Save possible 1: Save impossible due to insufficient memory	

## **14 Item Show/Hide Function**

---



## 14.1 Overview

- The switch or numerical data display parts registered on the screen can be shown or hidden according to its operating status.

The "show/hide" attribute can be set using methods including device memory bit activation in the PLC, bit/word designation, or commands.

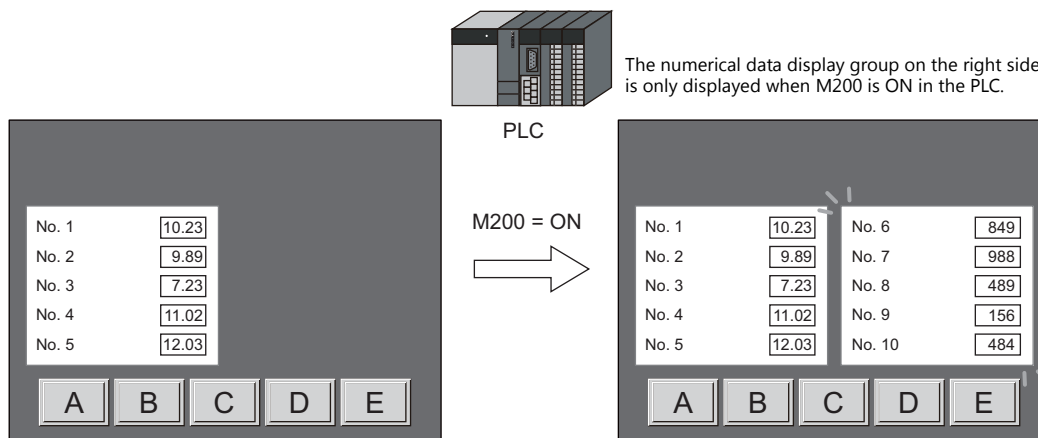

Refer to "14.2 Setting Examples" page 14-2

- Registered items can be set with the show/hide attribute even if they will not be actually used. For example, if future additions of items are planned, the items to be added can be registered in advance and set with the hide attribute, which will make future programming easier.

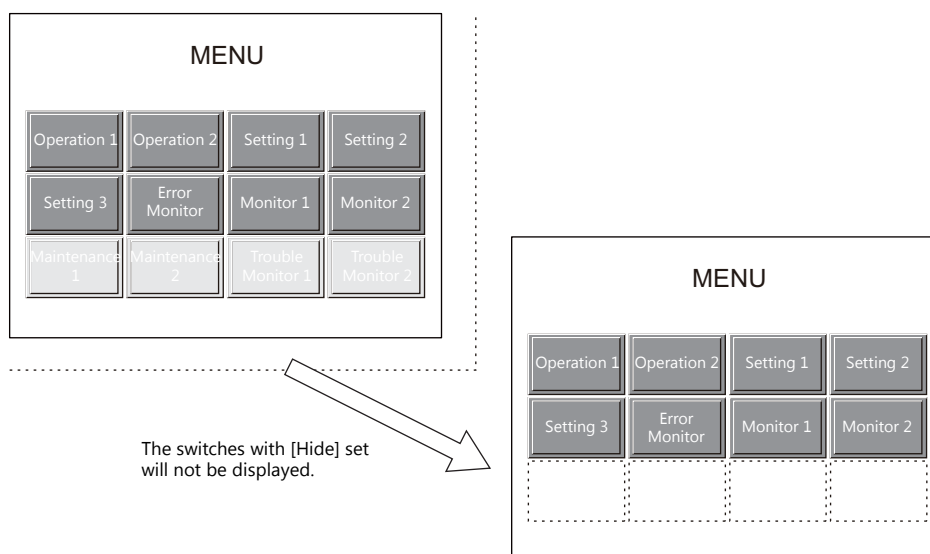

- Items which were placed overlapping will be displayed in the same order that they were placed even if they are hidden and shown again.

## 14.2 Setting Examples

### 14.2.1 Displaying Items when the Corresponding Bit Turns ON

#### Screen Creation

1. Place a numerical data display and character display on the screen.
2. Configure the [Bit device] settings via [Show/Hide].

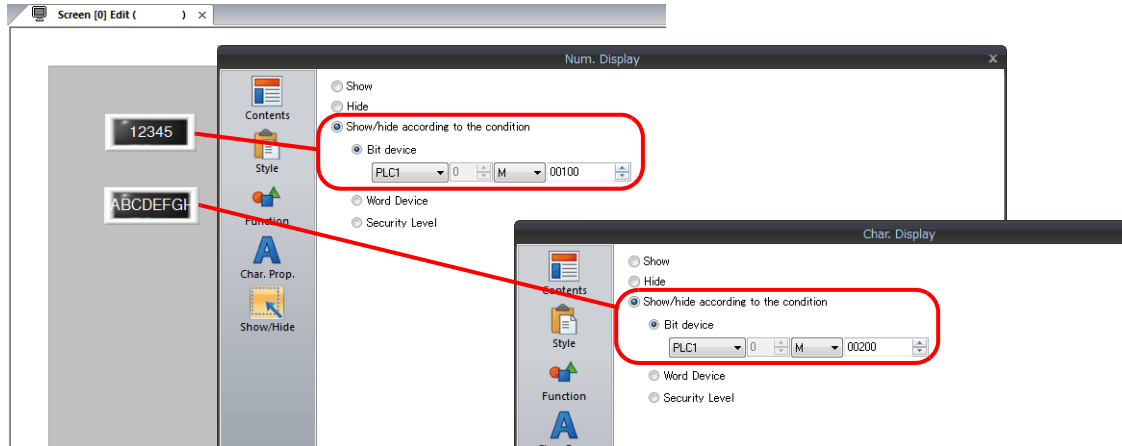

#### Unit Operation

1. When M100 is set to ON via the PLC, the numerical data display is shown.

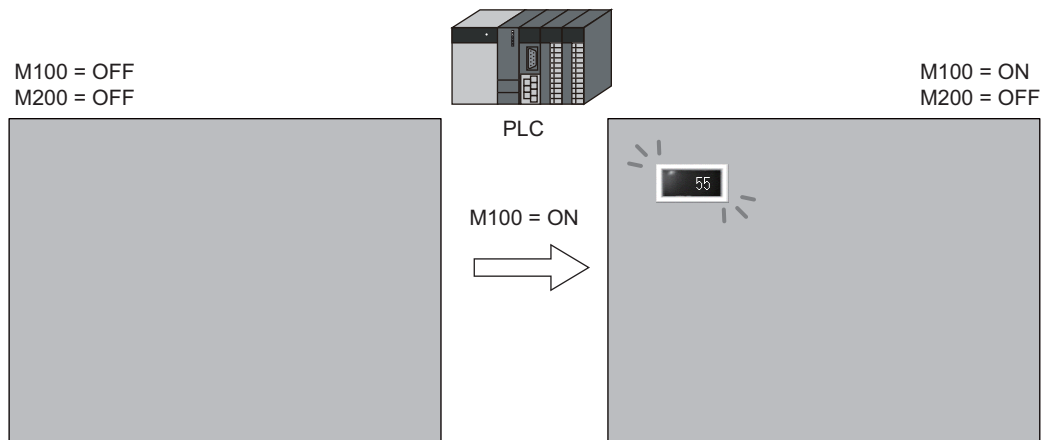

2. When M200 is set to ON via the PLC, the character display is shown.

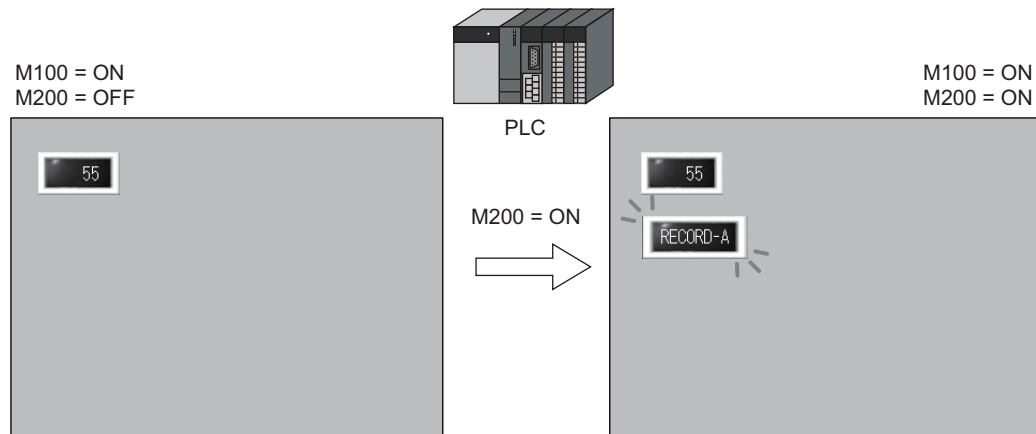

3. When M100 and M200 are set to OFF, the numerical data display and character display are hidden.

## 14.2.2 Displaying Items Using Device Memory Values

### Screen Creation

1. Place a switch.
2. Configure the [Word Device] settings via [Show/Hide].

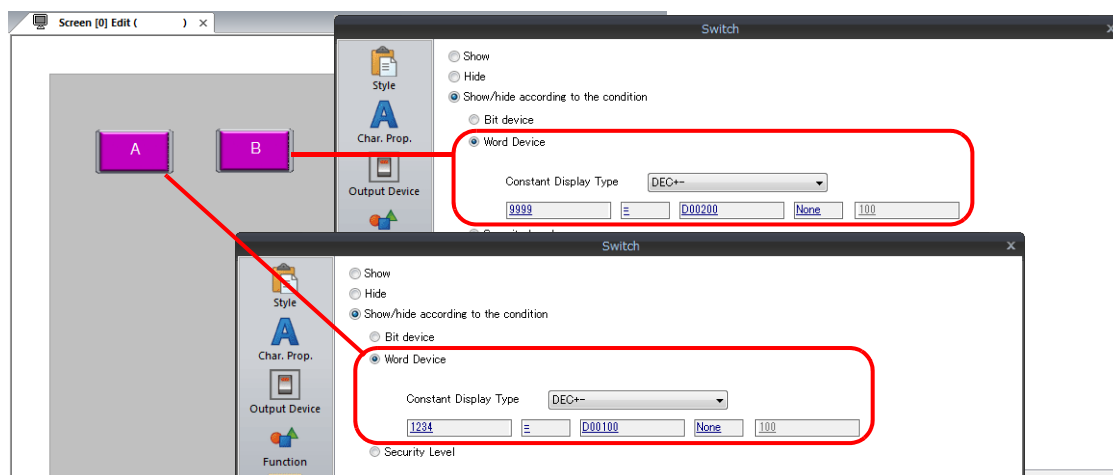

### Unit Operation

1. When D100 is set to "1234" via the PLC, switch A on the left is shown.

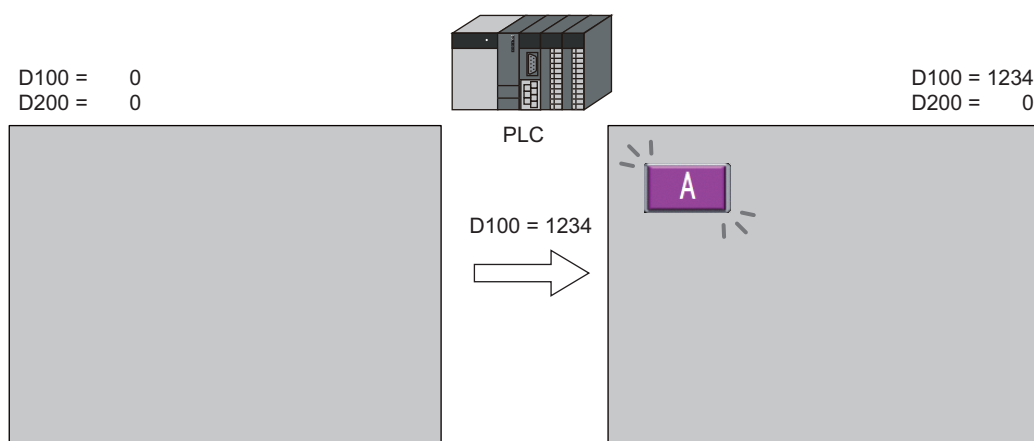

2. When D100 is left as "1234" and D200 is set to "9999" via the PLC, switch B on the right is shown.

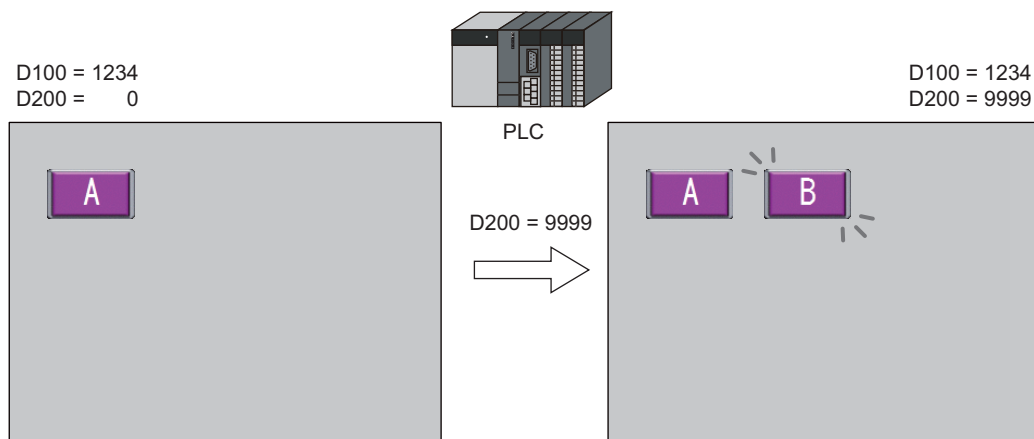

3. When D100 and D200 are both set to "0", the switches are hidden.

## 14.2.3 Displaying Items Using the Level of the Security Function

### Screen Creation

1. Place a switch that initiates operation.
2. Set the level of [Security Level] to "2" via [Show/Hide].

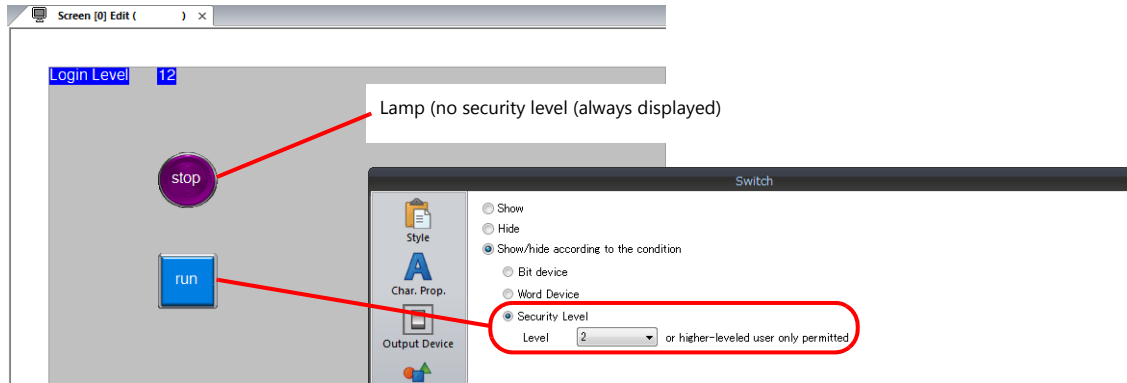

\* Always turn on the security function. Items with security levels will not be displayed if the security function is not turned on.

### Unit Operation

1. A lamp is displayed on the screen (security level 0).

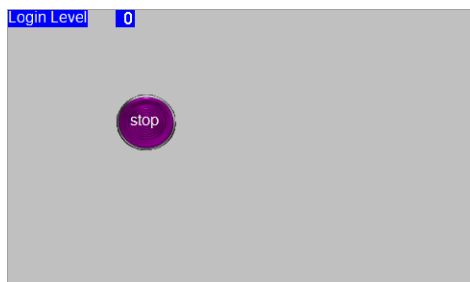

2. Enter the ID and password for level 2 on the login screen of the security function. The login level changes to level 2 and the operation switch is displayed.

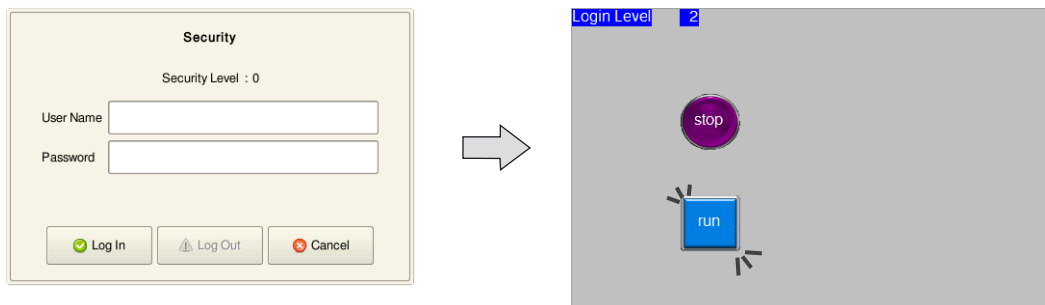

3. Users with a login level of 2 to 15 can operate the operation switch.

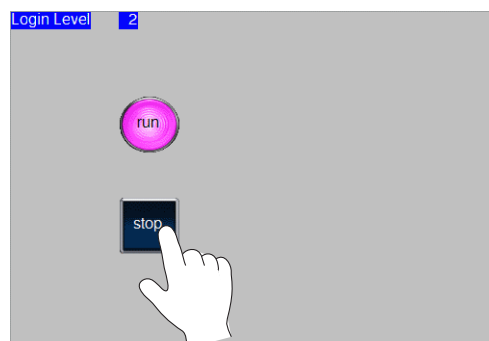

4. When a user logs off, the login level changes to 0 and the operation switch becomes hidden.

## 14.3 Detailed Settings

### Show/Hide

Configure the [Show/Hide] settings for each item.

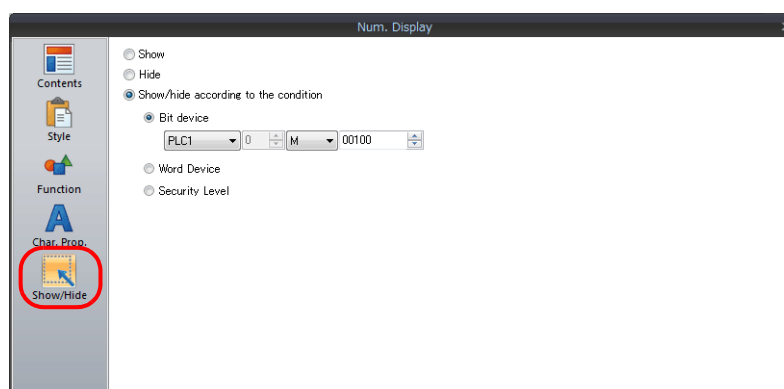

Item	Description
Show	Always show the item on the screen.
Hide	Always hide the item on the screen.
Show/hide according to the condition	Items are shown or hidden depending on the specified condition.
Bit device	The item is shown or hidden according to the activation at the address specified in a bit device memory. Bit ON: Item shown Bit OFF: Item hidden
Word Device	The item is shown or hidden according to the status at the address specified in a word device memory. Set the range of item display using the < ≤ = ≠ operators.
Security Level	Used in conjunction with the security function. Items are shown or hidden according to the login level. For details on the security function, refer to "5 Security" in the V9 Series Reference Manual 2.

### Screen Settings

Set the timing of item drawing via [Screen Setting] → [Screen Setting] → [Unhide].

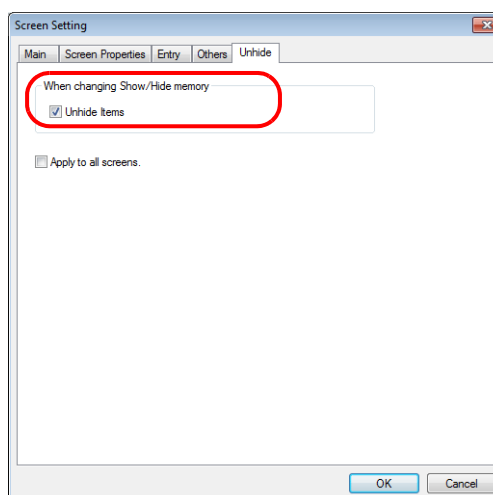

Item	Description
Unhide items	Selected Perform item redisplay when the state of [Show/Hide] for an item changes. Unselected Perform redisplay immediately after changing screens or only when executing the "SYS (RESET_SCRN)" macro.
Apply to all screens	Apply the above settings to all screens.

## 14.4 Checking Settings

Use the following method to check the [Show/Hide] settings of items.

### Item List

Display the [Item List] window from the [View] menu.

Items with [Show/Hide] settings are shown in green, yellow or light blue. Uncolored items correspond to items for which [Show] is selected.

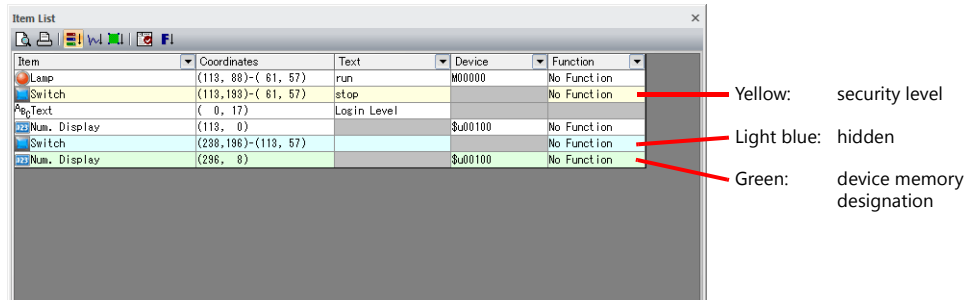

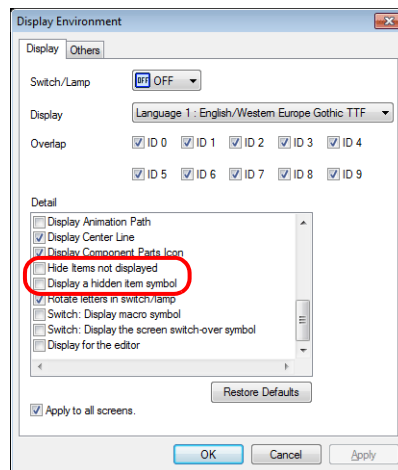

### Display Environment Settings

Select [View] → [Display Environment].



Item	Description
Hide Items not displayed	Items with [Show/Hide] settings are not displayed on the screen.
Display a hidden item symbol	Display a hidden item symbol for items with [Show/Hide] settings.

Symbol	Setting
None	Show
Light blue 	Hide
Green 	Show/Hide according to the condition
Yellow 	Security Level

\* The same settings can be made via the right-click menu on the screen.

## **15 Recipes**

---

# 15.1 Overview

## 15.1.1 Recipes

In manufacturing, the conditions and data that are critical for making products are collectively referred to as a "recipe". For example, when beverages are produced on the factory floor of a beverage manufacturer, the conditions for producing apple juice and orange juice differ with respect to ingredients and production processes for each type of beverage.

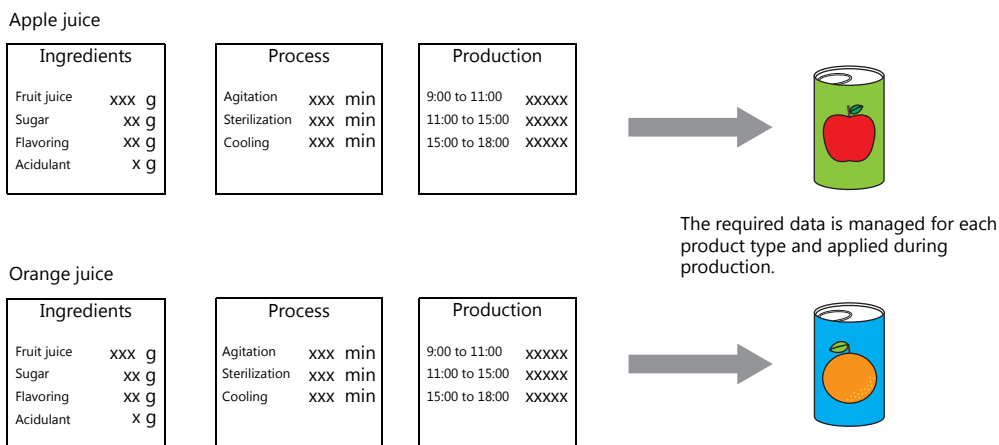

In order to produce and deliver products at a constant quality, the use of recipe information specific to each product is very important.

Recipes for products to be made on a particular day are managed on the factory floor, and smoothly changing between recipes according to the production conditions results in efficient production of higher quality products.

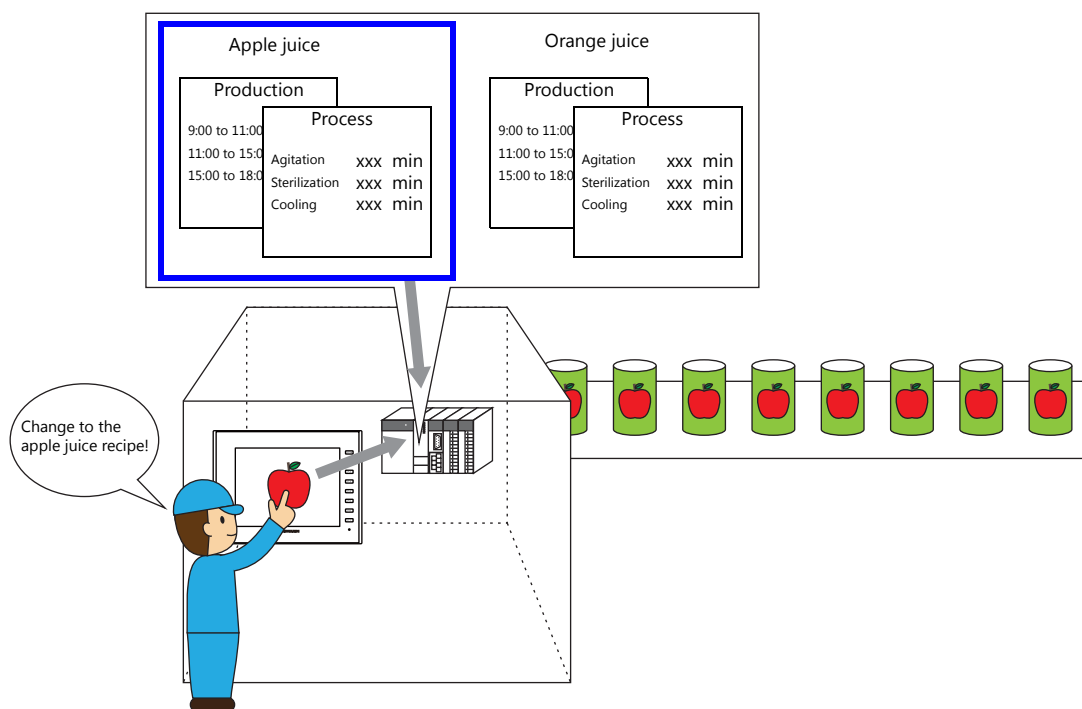



## 15.1.2 Recipe Function

Precise and easy management of recipes, as described in the previous section, on the factory floor is a requirement. Recipes comprise different information depending on product type and may undergo modification on the factory floor. Recipe data can be managed without stress by managers on the factory floor if data on a PLC can be substituted or changed according to circumstance.

The advantages of using the recipe function of the V9 series unit can be realized in various situations.

### Structure

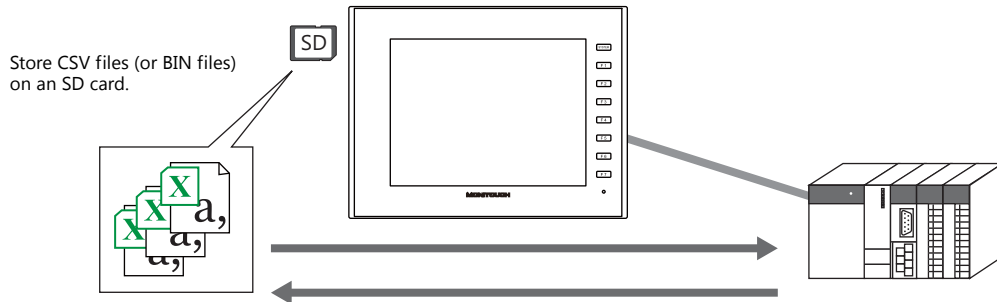

- Recipe data is stored in the CSV or BIN file format and can be read or written by the V9 series unit. An external storage device (i.e. SD card) is required to store files.
- Data can be read and written in units of files or records.

	A	B	C	Files	
APPLE	60	110	250	3	
ORANGE	60	110	220	10	Data G
GRAPE	50	85	240	8	4200
LEMON	40	60	220	11	4500
PEACH	80	120	240	15	800
Type D		2200	1500	8	5000
Gross		1100	1200	1000	

- Not only can data on an SD card be read or written, additions to data and new data can also be created.

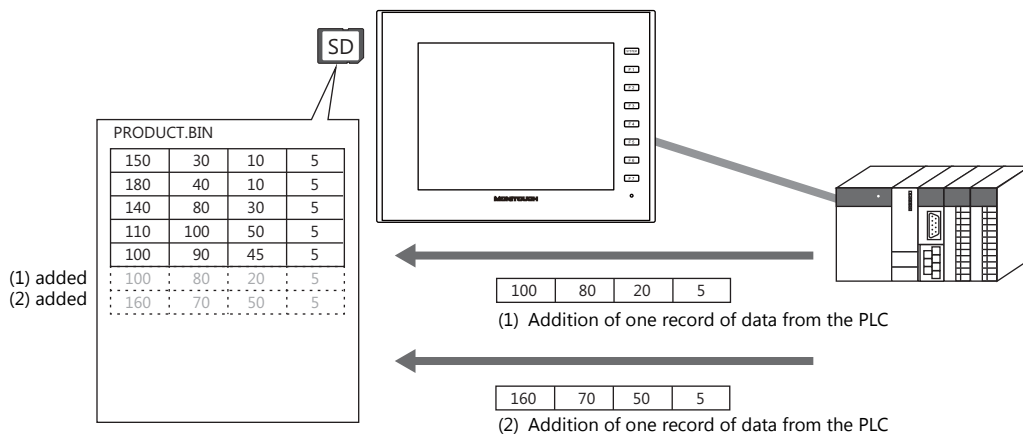

- CSV and BIN files can be easily created and edited using the screen configuration software.
- Settings including the format of each file and bits for commanding transfer are specified in the recipe settings in the screen configuration software.

## Operations

The recipe function performs the following operations.

- Reading and writing of files (CSV/BIN)  
For details on these operations, refer to [“15.3 Reading Recipes in Units of Files When the PLC Bit Turns ON”](#) and [“15.4 Reading Recipes in Units of Files with Switch Operations”](#).
- Reading and writing of records  
For details on these operations, refer to [“15.5 Reading Recipes in Units of Records”](#) and [“15.6 Writing Recipes in Units of Records”](#).

There are two types of control modes in which operation execution commands can be issued. “Global control” allows commands to be executed regardless of the display state of MONITOUCH, and “local control” only accepts commands when a specific screen is displayed.

These modes are described below.

### Global Control

Recipe operations can be performed when any screen is displayed using commands from a PLC because reading and writing of data is performed according to a control bit from the PLC, as specified in the recipe settings.

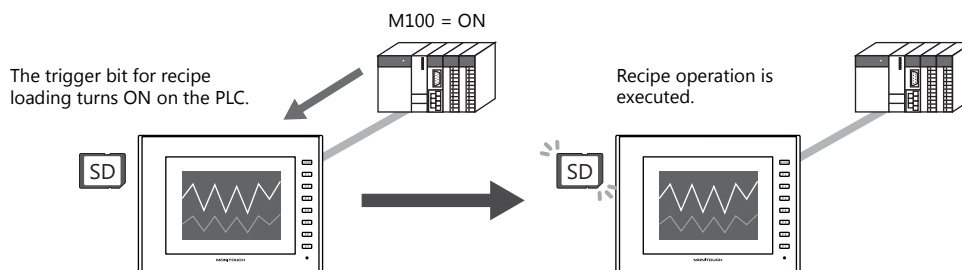

### Local Control

Recipe operations are only possible using switches placed on a screen for executing the relevant recipe operations.

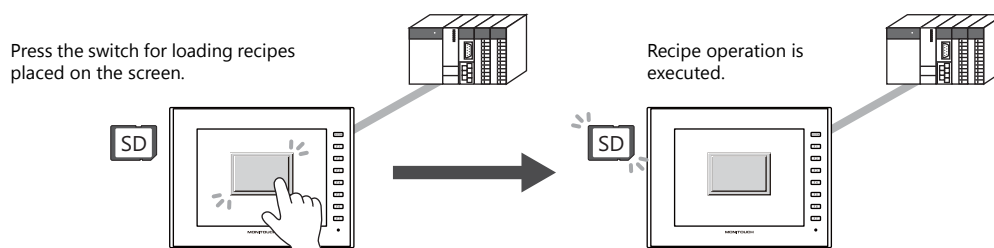

## 15.2 Creating Recipe Data (BIN/CSV Files)

### 15.2.1 Using the Screen Configuration Software

The screenshot shows the 'Data' configuration window in the software. The 'Transfer Command' is set to 'REC0000 bin (New)'. The 'Data Type' is set to 'DEC'. The 'Data' section shows a table with 4 columns: 'No.1 DEC(WORD)', 'No.2 DEC(WORD)', 'No.3 DEC(WORD)', and 'No.4 DEC(WORD)'. The 'Data Type' is set to 'DEC'. The 'Data Length' is set to '1-Word'. The 'Decimal Point' is set to '0'. The 'Transfer Target' is set to 'Data'. The 'Device Designation' is set to 'Specify consecutively'. The 'Top device' is set to 'D100'.

	Fruit juice	Sugar	Flavoring	Acidulant
APPLE	150	30	10	5
ORANGE	180	40	10	5
GRAPE	140	80	30	5
LEMON	110	100	50	5
PEACH	100	90	45	5

	Agitation time	Sterilization time	Cooling time
APPLE	60	110	250
ORANGE	60	110	220
GRAPE	50	85	240
LEMON	40	60	220
PEACH	80	120	240

This section explains the procedure for creating BIN files such as the above two as an example.

## Setting Procedure

### File Format/Format Settings

1. Because two BIN files of different formats are being created, recipe registration is separated into number 0 and number 1. The creation procedure for number 0, PRODUCT.BIN, is explained first. Click [System Setting] → [Recipe] and select "0" for [No.]. The [Recipe [0]] window is displayed.
2. On the [Standard Operation] tab window, select [File-based transfer] for [Data to Transfer]. Configure the other settings as shown below.

Storage Target Folder	(Blank = directly under the "RECIPE" folder)
File Type	BIN
Storage Target File	File Name Designation
Filename	PRODUCT (bin)

3. Next, select the [File Format] tab window. Configure the following settings.

Add record name	Selected
Add title to data	Selected
Number of Records	5
Number of Data	4
Record Name: Characters	8
Record Name: Text Process	LSB->MSB
Data Type	DEC
Data Length	1-Word
Decimal Point	0
Transfer Target	Data
Device Designation	Specify consecutively
Top device	D100

## Creating BIN Files

1. Select the [Recipe Data] tab window. Click [Create File].  
[PRODUCT.bin (New)] is shown as the title of the creation area on the right and a creation menu is displayed.
2. First, enter title names. Double-click each title name to enter text.
3. Next, enter record names. Double-click each record in the same manner to enter text.
4. Edit each entry of recipe data.
5. After editing the required number of entries, click [Save As] and save the file.

## Creating Recipe No. 1

1. Create recipe number 1 in the same manner as recipe number 0.  
Click [System Setting] → [Recipe] and select "1" for [No.].  
The [Recipe [1]] window is displayed.
2. Create a file in the same manner as number 0.  
However, set "3" for [Number of Data] because WORK.BIN has three columns in this example.

## Storing on an SD Card

1. Connect the SD card to the PC and click [File] → [Storage Manager].

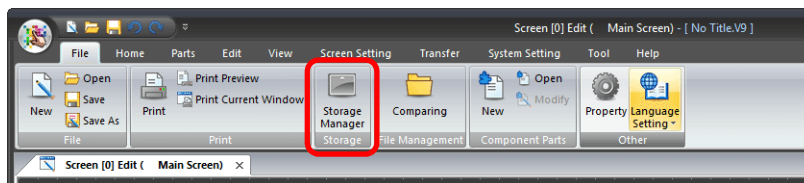

2. The [Storage Drive Select] window is displayed.

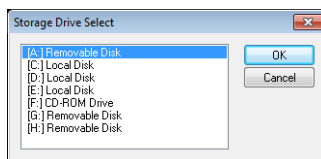

3. Specify the drive of the SD card connected in step 1 and click [OK].  
The [Storage Manager] window is displayed.

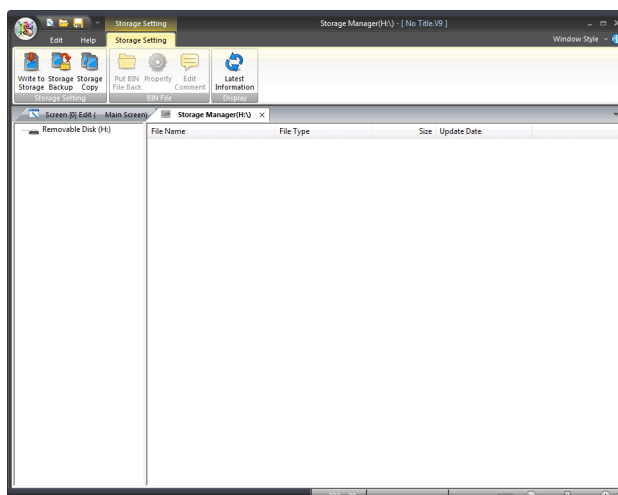

4. Click the [Write to Storage] button on the [Storage Setting] menu.

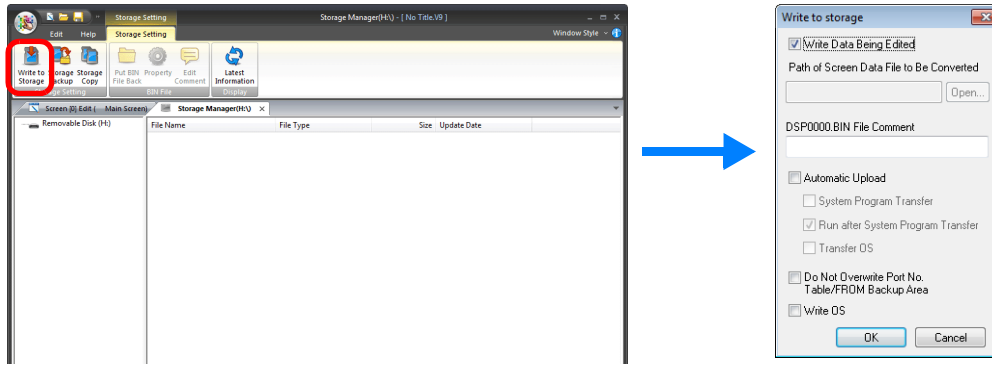

5. In the [Write to storage] window, check that the [Write Data Being Edited] checkbox is selected and click [OK].
6. An access folder is created on the SD card drive in the [Storage Manager] window. Check that a "RECIPE" folder is created along with some other folders on the SD card drive and then close the [Storage Manager] window.
7. Next, save the created BIN files to the "Recipe" folder that was confirmed to exist in step 6.  
Either use Windows Explorer to copy the files or click the [Save As] button on the [Recipe Data] tab window in the recipe settings to save the files directly to the "Recipe" folder.

## 15.2.2 Creating Recipes Using Excel (CSV Files Only)

### Setting Procedure

#### File Format/Format Settings

1. Configure the [Standard Operation] and [File Format] tab windows with the same settings as the BIN files in the previous section.

- [Standard Operation] tab window

Storage Target Folder	Any location on the SD card
File Type	CSV
Storage Target File	File Name Designation
Filename	PRODUCT (csv)

- [File Format] tab window

Add record name	Selected
Add title to data	Selected
Number of Records	5
Number of Data	4
Record Name: Characters	8
Record Name: Text Process	LSB->MSB
Data Type	DEC
Data Length	1-Word
Decimal Point	0
Transfer Target	Data
Device Designation	Specify consecutively
Top device	D100

### Creating CSV Files

1. Start Excel.  
Edit the data in Excel in the intended format.
2. Save the data. Click [File] → [Save As].
3. Select "CSV (Comma delimited) (\*.csv)" for [Save as type], specify a filename, and save the file.

### Storing on an SD Card

1. Connect the SD card to the PC and click [File] → [Storage Manager].

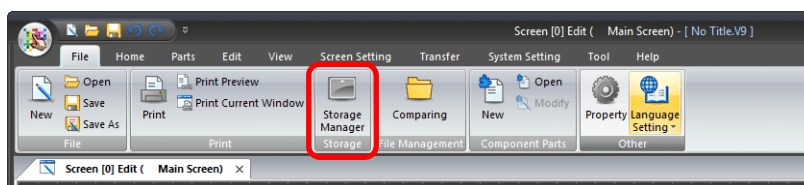

2. The [Storage Drive Select] window is displayed.

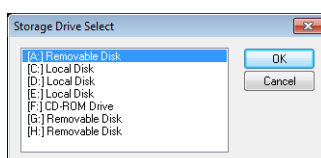

- Specify the drive of the SD card connected in step 1 and click [OK].  
The [Storage Manager] window is displayed.

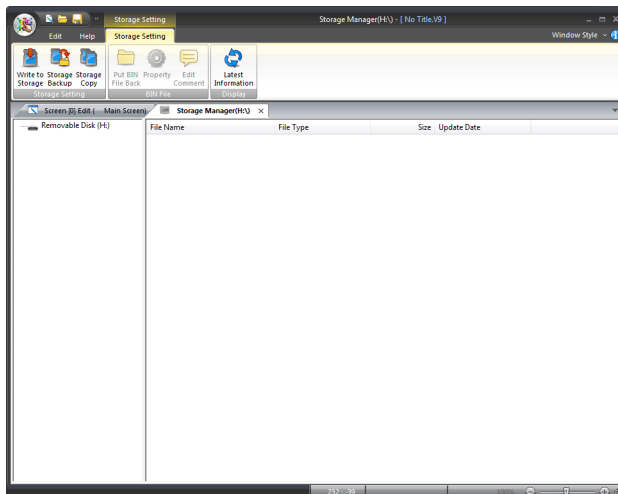

- Click the [Write to Storage] button on the [Storage Setting] menu.

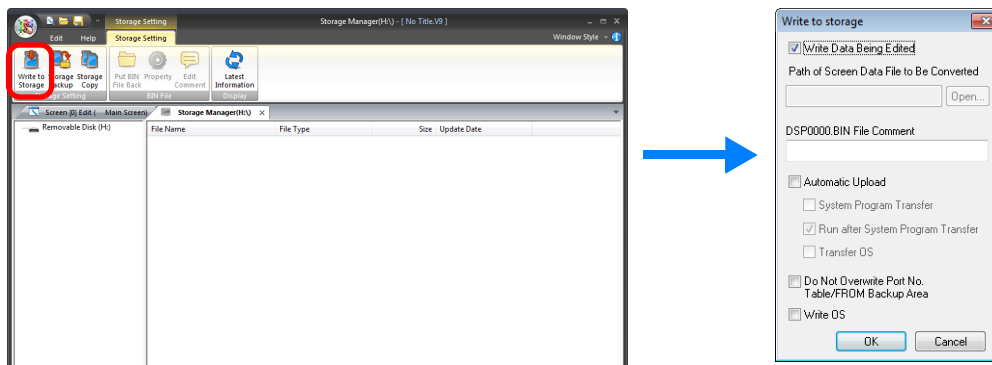

- In the [Write to storage] window, check that the [Write Data Being Edited] checkbox is selected and click [OK].
- An access folder is created on the SD card drive in the [Storage Manager] window. Check that a "RECIPE" folder is created along with some other folders on the SD card drive and then close the [Storage Manager] window.
- Next, save the created CSV file to the "RECIPE" folder that was confirmed to exist in step 6.  
Copy the file using Windows Explorer.

## 15.3 Reading Recipes in Units of Files When the PLC Bit Turns ON

### 15.3.1 Conceptual Operation

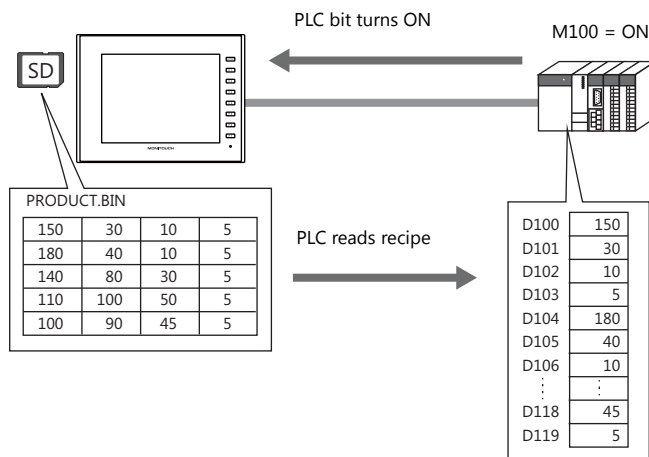

- \* PLC data can also be written to files. PLC data is written to a BIN file when the relevant bit turns ON. If a BIN file does not exist, a new BIN file is created automatically.

### 15.3.2 Setting Procedure

- Click [System Setting] → [Recipe] and select "0" for [No.]. The [Recipe [0]] window is displayed.
  - On the [Standard Operation] tab window, select [File-based transfer] for [Data to Transfer].
  - Select [File Name Designation] for [Storage Target File] and define the name of the file for reading (e.g. PRODUCT.bin).
    - \* Select the [Designate by device] checkbox under the filename to allow reading by a specified device memory address such as of a PLC. A fixed file is targeted in this example.
  - Display the [File Format] tab window.
  - Select [Specify consecutively] for [Device Designation] under [Transfer Device Setting] and specify the top device memory address (e.g. D100).
  - Display the [Transfer Command] tab window.
  - Select the [MONITOUCH → PLC] checkbox under [Add Transfer Condition].
    - Define the PLC bit (e.g. M100) for [Device].
    - Select [Transfer when bit [ON]] for [Trigger Select].
- This completes the necessary settings. The screen program can be transferred to MONITOUCH.

### 15.3.3 Operating Procedure

- With the recipe file stored on an SD card, the relevant bit (e.g. M100) on the PLC turns ON.
- The data of the file defined in step 3 of the previous section is read out sequentially to the reading destination starting from the top device memory address (e.g. D100).



## 15.4 Reading Recipes in Units of Files with Switch Operations

### 15.4.1 Conceptual Operation

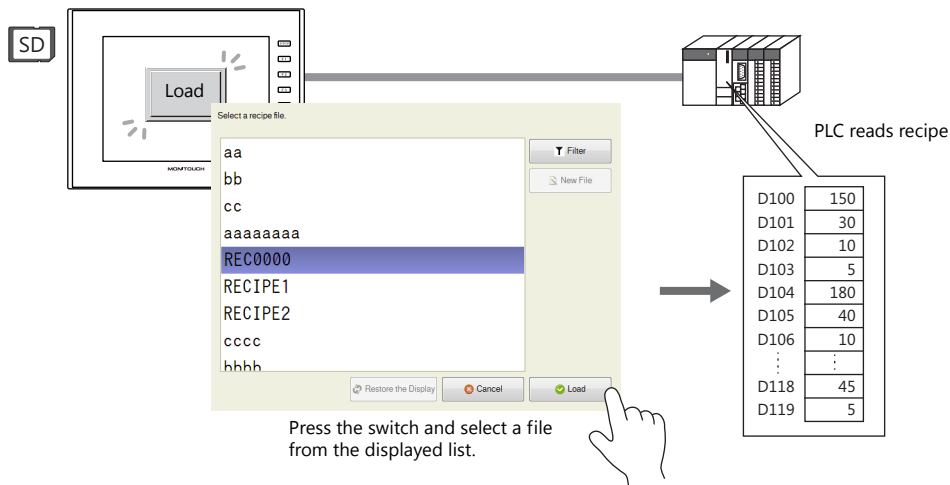

\* PLC data can also be written to files. Pressing the switch writes the PLC data to the selected file. If a file does not exist, a new file is created automatically.

### 15.4.2 Setting Procedure

1. Click [System Setting] → [Recipe] and select "0" for [No.]. The [Recipe [0]] window is displayed.
2. On the [Standard Operation] tab window, select [File-based transfer] for [Data to Transfer].
3. Display the [File Format] tab window.
4. Select [Specify consecutively] for [Device Designation] under [Transfer Device Setting] and specify the top device memory address (e.g. D100).
5. Next, configure the switch settings.  
In the switch settings window, change "Standard" to "Recipe" under [Function] in the [Function] settings and then select "Recipe Data Load".
6. Select [0], which was specified in step 1, for [Recipe]. The switch settings differ depending on the selection made here.
7. Select the [Select at the time of execution] checkbox for [File Selection].  
(When there is only one file, specify a value for [Specify the number] or [Specify the name].)

This completes the necessary settings. The screen program can be transferred to MONITOUCH.

### 15.4.3 Operating Procedure

1. With the recipe file stored on an SD card, press the switch (set with "Recipe Data Load" for [Function]) on the screen. A list window for automatic file selection is displayed.

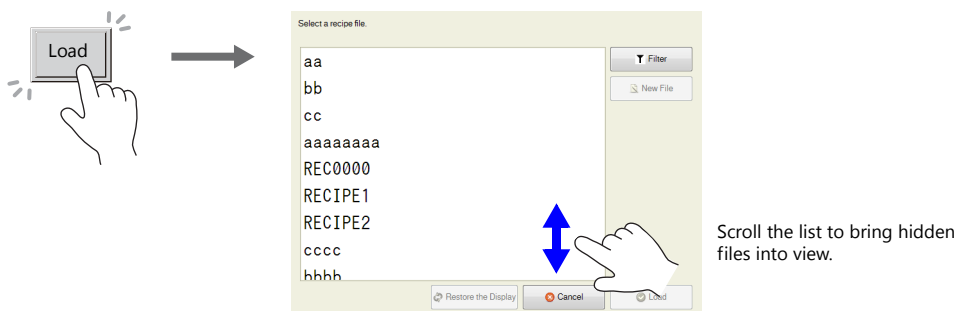

2. Select a file and press the [Load] button to sequentially read out to the reading destination starting from the top device memory address (e.g. D100). When there are files that cannot be viewed in the window at once, either scroll or perform filtering to bring them into view. For more information on filtering, refer to the next page.

## Reading Out by Searching for Filenames (Filtering)

When there are many files, searching for filenames (filtering) can be used to find files.

\* Searching for record names (filtering) is also possible.

1. With the recipe file stored on an SD card, press the switch (set with "Recipe Data Load" for [Function]) on the screen. A list window for automatic file selection is displayed.

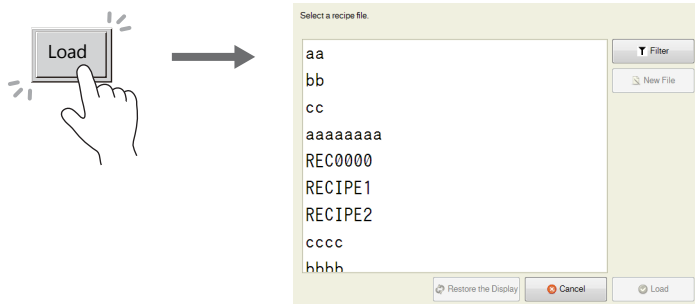

2. Press the [Filter] button to display the following filtering window. Enter the first few characters of the filename.

\* Press the text field to automatically display the system keyboard. Use this keyboard to enter text.

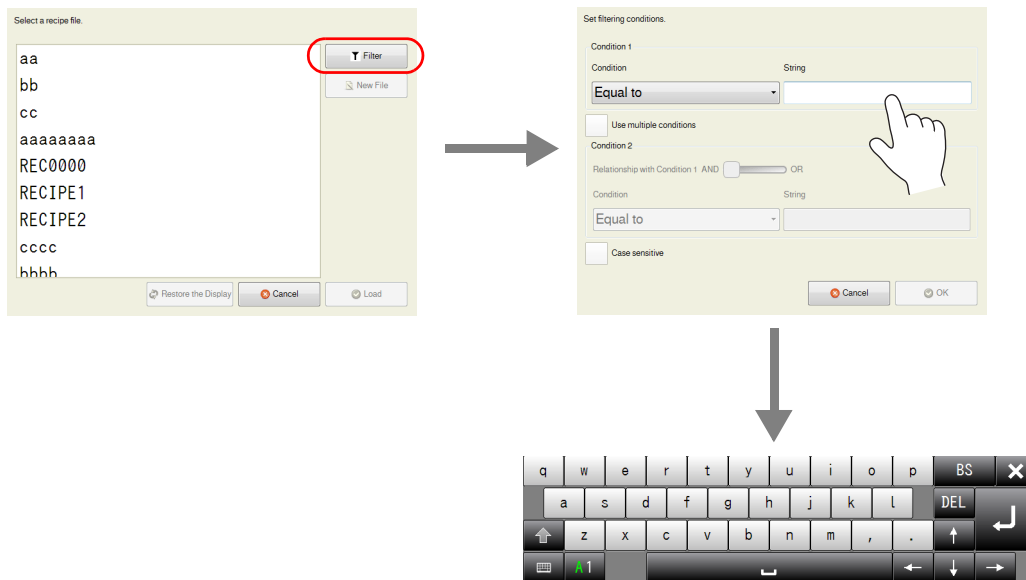

3. Press [OK] to display a list of files with filenames that contain the entered text. When there are files that cannot be viewed in the window at once, the entire list can be checked by scrolling.



4. Find the target file, select it, and press [Load]. The target file is read out sequentially to the reading destination starting from the top device memory address (e.g. D100).



The recipe data of the file is read into the PLC.

## 15.5 Reading Recipes in Units of Records

### 15.5.1 Specifying Record Numbers for Reading

#### Conceptual Operation

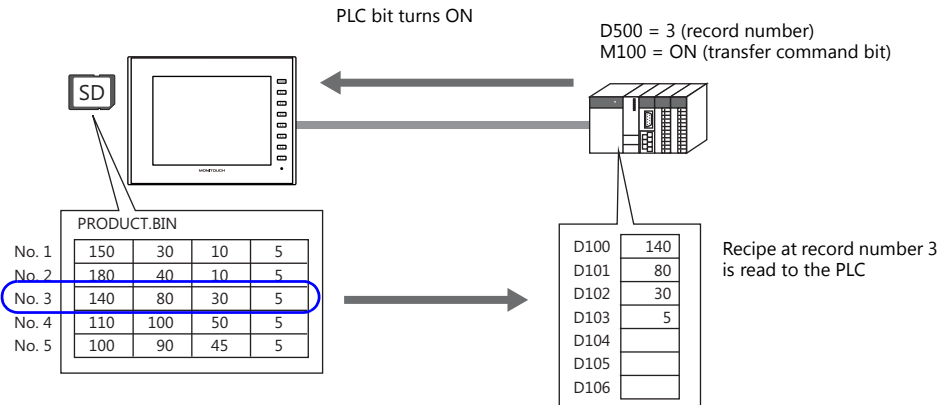

#### Setting Procedure

1. Click [System Setting] → [Recipe] and select "0" for [No.]. The [Recipe [0]] window is displayed.
2. On the [Standard Operation] tab window, select [Record-based transfer] for [Data to Transfer].
3. Select [File Name Designation] for [Storage Target File] and define the name of the file for reading (e.g. PRODUCT.bin).
4. For the [Transfer Record] settings, select the [Designate by device] checkbox next to [Record Number Designation]. Define the device memory address for record number designation (e.g. D500).
5. Display the [File Format] tab window.
6. Select [Data] for [Transfer Target] under [Transfer Device Setting] and specify the top device memory address (e.g. D100).
7. Display the [Transfer Command] tab window.
8. Select the [MONITOUCH → PLC] checkbox under [Add Transfer Condition]. Define the PLC bit (e.g. M100) for [Device]. Select [Transfer when bit [ON]] for [Trigger Select].

This completes the necessary settings. The screen program can be transferred to MONITOUCH.

#### Operating Procedure

1. With the recipe file stored on an SD card, specify "3" for the device memory address (e.g. D500) on the PLC.
2. In addition, set the relevant bit (e.g. M100) to ON.
3. The data of record number 3 in the file defined in step 3 of the previous section is read out sequentially to the reading destination starting from the top device memory address (e.g. D100).

## 15.6 Writing Recipes in Units of Records

### 15.6.1 Specifying Record Names for Writing

#### Conceptual Operation

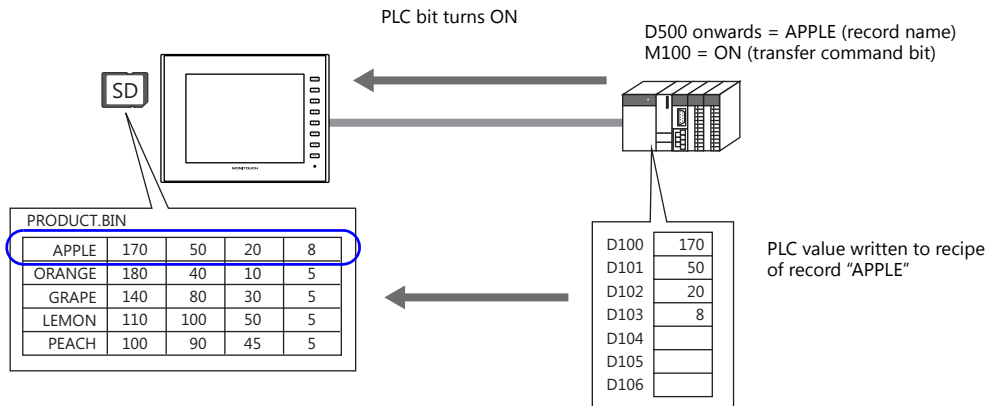

#### Setting Procedure

1. Click [System Setting] → [Recipe] and select "0" for [No.]. The [Recipe [0]] window is displayed.
2. On the [Standard Operation] tab window, select [Record-based transfer] for [Data to Transfer].
3. Select [File Name Designation] for [Storage Target File] and define the name of the file for reading (e.g. PRODUCT.bin).
4. For the [Transfer Record] settings, select the [Designate by device] checkbox next to [Record Name Designation].  
Define the device memory address for record name designation (e.g. D500).
5. Display the [File Format] tab window.
6. Select [Data] for [Transfer Target] under [Transfer Device Setting] and specify the top device memory address (e.g. D100).
7. Display the [Transfer Command] tab window.
8. Select the [PLC → MONITOUCH] checkbox under [Add Transfer Condition].  
Define the PLC bit (e.g. M100) for [Device].  
Select [Transfer when bit [ON]] for [Trigger Select].

This completes the necessary settings. The screen program can be transferred to MONITOUCH.

#### Operating Procedure

1. With the recipe file stored on an SD card, specify the record name (e.g. "APPLE") to the device memory address (e.g. D500) on the PLC using ASCII code characters.
2. In addition, set the relevant bit (e.g. M100) to ON.
3. The data stored in the transfer device memory (e.g. D100) is written sequentially starting from the top address to the "APPLE" record in the file defined in step 3 of the previous section.

## 15.6.2 Creating New Records

New records can be created by defining record numbers or records names that do not currently exist and executing writing.

\* Files can also be created in the same manner.

### Conceptual Operation

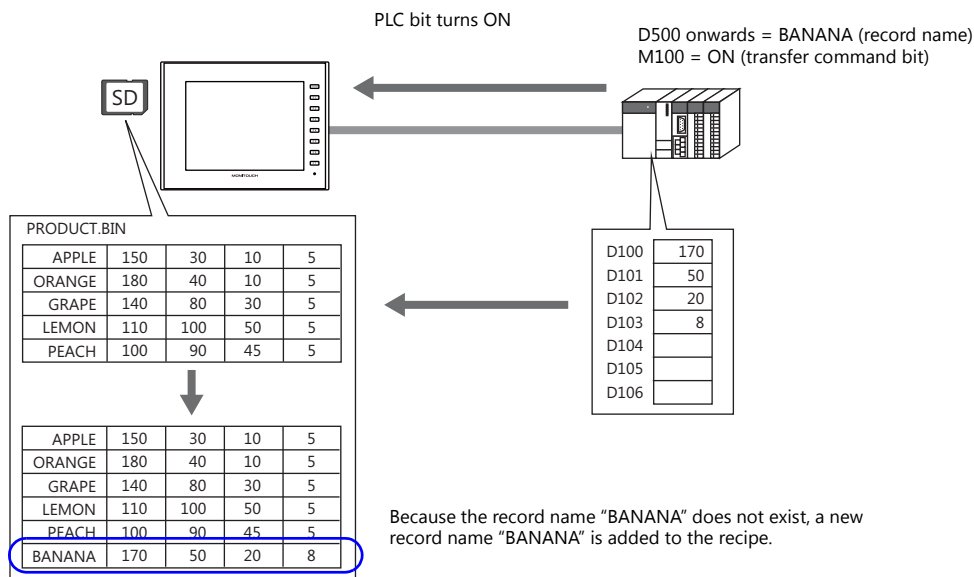

### Setting Procedure

1. Click [System Setting] → [Recipe] and select "0" for [No.]. The [Recipe [0]] window is displayed.
2. On the [Standard Operation] tab window, select [Record-based transfer] for [Data to Transfer].
3. Select [File Name Designation] for [Storage Target File] and define the name of the file for reading (e.g. PRODUCT.bin).
4. For the [Transfer Record] settings, select the [Designate by device] checkbox next to [Record Name Designation]. Define the device memory address for record name designation (e.g. D500).
5. Display the [File Format] tab window.
6. Select [Data] for [Transfer Target] under [Transfer Device Setting] and specify the top device memory address (e.g. D100).
7. Display the [Transfer Command] tab window.
8. Select the [PLC → MONITOUCH] checkbox under [Add Transfer Condition]. Define the PLC bit (e.g. M100) for [Device]. Select [Transfer when bit [ON]] for [Trigger Select].

This completes the necessary settings. The screen program can be transferred to MONITOUCH.

### Operating Procedure

1. With the recipe file stored on an SD card, specify the record name (e.g. "BANANA") to the device memory address (e.g. D500) on the PLC using ASCII code characters.
2. In addition, set the relevant bit (e.g. M100) to ON.
3. Because the record name "BANANA" does not exist in the file defined in step 3 of the previous section, the data in the transfer device memory (e.g. D100) is written sequentially starting from the top address to a newly added record named "BANANA".

## Difference in Operation Between Record Name Designation and Record Number Designation

When creating in units of records, operation differs between creating a new record name and creating a record number.

- Record name

When a new record name is created that did not previously exist, records are added by inserting a line at the end of the relevant file.

APPLE	60	110	250
GRAPE	50	85	240
LEMON	40	60	220
PEACH	80	120	240



APPLE	60	110	250
GRAPE	50	85	240
LEMON	40	60	220
PEACH	80	120	240
ORANGE	60	110	220

- Record number

When a new record number is created that did not previously exist, a new record is created with the specified record number. If there is a gap between the end number and the new number, empty lines are registered.

No. 1	60	110	250
No. 2	50	85	240
No. 3	40	60	220



No. 1	60	110	250
No. 2	50	85	240
No. 3	40	60	220
No. 4	0	0	0
No. 5	0	0	0
No. 6	0	0	0
No. 7	0	0	0
No. 8	60	110	220

## 15.7 Checking that the Recipe Function is Operating Correctly

### 15.7.1 Conceptual Operation

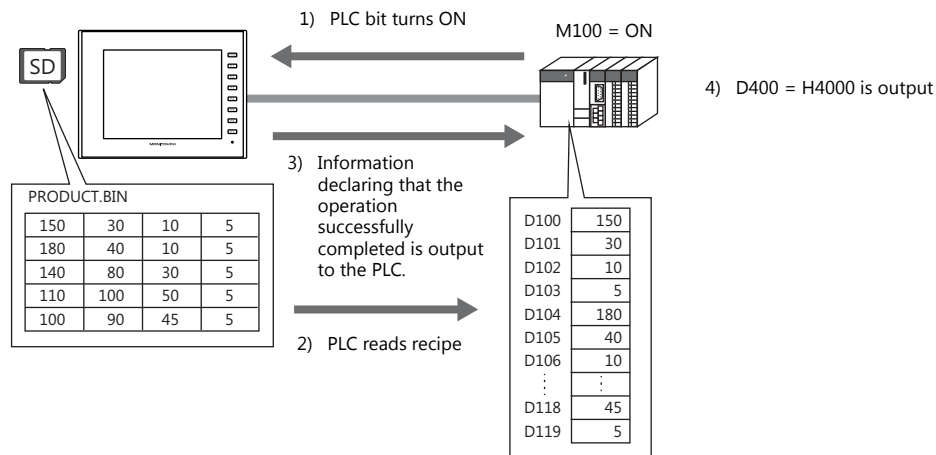

### 15.7.2 Setting Procedure

- Click [System Setting] → [Recipe] and select "0" for [No.]. The [Recipe [0]] window is displayed.
- On the [Standard Operation] tab window, select [File-based transfer] for [Data to Transfer].
- Select [File Name Designation] for [Storage Target File] and define the name of the file for reading (e.g. PRODUCT.bin).
  - \* Select the [Designate by device] checkbox under the filename to allow reading by a specified device memory address such as of a PLC. A fixed file is targeted in this example.
- Display the [File Format] tab window.
- Select [Specify consecutively] for [Device Designation] under [Transfer Device Setting] and specify the top device memory address (e.g. D100).
- Display the [Transfer Command] tab window.
- Select the [MONITOUCH → PLC] checkbox under [Add Transfer Condition].
  - Define the PLC bit (e.g. M100) for [Device].
  - Select [Transfer when bit [ON]] for [Trigger Select].
- Select the [Use Info Output Device] checkbox under [Device Setting] and specify a device memory address (e.g. D400). This completes the necessary settings. The screen program can be transferred to MONITOUCH.

### 15.7.3 Checking Procedure

- With the recipe file stored on an SD card, the relevant bit (e.g. M100) on the PLC turns ON.
  - The data of the file defined in step 3 of the previous section is read out sequentially to the reading destination starting from the top device memory address (e.g. D100).
  - Check the D400 setting. If transfer was completed successfully, the 14th bit turns ON (D400 = H4000).
- \* The content of the information output device memory is shown below. For details, refer to [page 15-21](#).

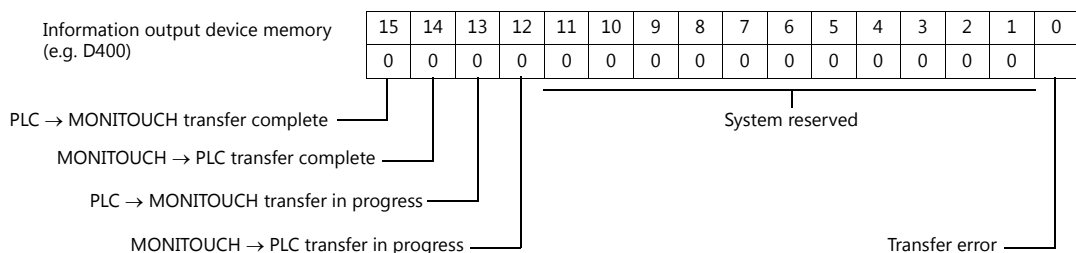



## 15.8 Detailed Settings

### 15.8.1 Location of Settings

Click [System Setting] → [Recipe].

A window for specifying the recipe number is displayed. Select a number and click [OK].

The [Recipe] settings window is displayed.

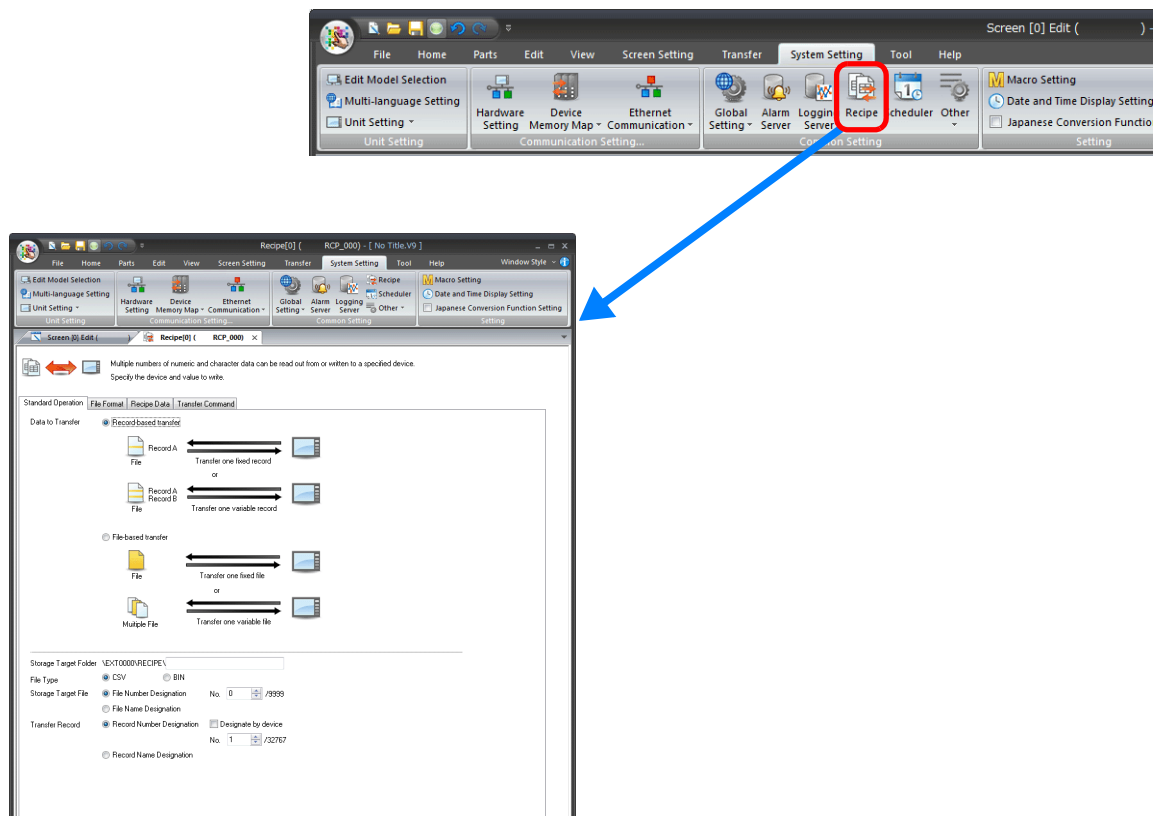

### 15.8.2 Recipe Settings (0 to 255)

The recipe settings area is used to newly register information when there are differences in the settings required for recipe management, such as the format of files that store recipe data and execution start bits etc. First, a number is set to the recipe setting.

#### [Standard Operation] Tab Window

Item		Description
Data to Transfer	Record-based transfer	Select this option to read and write recipe data in units of records (rows or columns).
	File-based transfer	Select this option to read and write recipe data in units of files.
Storage Target Folder		Define the storage target folder for files on the SD card. Define one folder per recipe setting.
File Type		Select the file format of the data to store.
Storage Target File	File Number Designation (0 to 9999)	Set the file number of the storage target. When the <input type="checkbox"/> Designate by device checkbox is selected, the storage target can be defined by specifying a number to a device memory address.
	File Name Designation	Set the filename of the storage target. When the <input type="checkbox"/> Designate by device checkbox is selected, the storage target can be defined by specifying a name to a device memory address.
Transfer Record	Record Number Designation (0 to 32767)	Set the record number of the storage target. When the <input type="checkbox"/> Designate by device checkbox is selected, the storage target can be defined by specifying a number to a device memory address.
	Record Name Designation	Set the record name of the storage target. When the <input type="checkbox"/> Designate by device checkbox is selected, the storage target can be defined by specifying a name to a device memory address.

\* BIN files result in faster processing speed on MONITOUCH than CSV files.  
However, checking and editing of BIN file content requires Hakko Electronics' "V-SFT" software.

## [File Format] Tab Window

Item	Description																																												
Line/Column Contents	<p>Line: Record, Column: Data</p> <p>Records</p> <table border="1" data-bbox="991 315 1430 477"> <tr><td>APPLE</td><td>60</td><td>110</td><td>250</td></tr> <tr><td>ORANGE</td><td>60</td><td>110</td><td>220</td></tr> <tr><td>GRAPE</td><td>50</td><td>85</td><td>240</td></tr> <tr><td>LEMON</td><td>40</td><td>60</td><td>220</td></tr> <tr><td>PEACH</td><td>80</td><td>120</td><td>240</td></tr> </table> <p style="text-align: center;">Data</p> <hr/> <p>Line: Data, Column: Record *1</p> <p>Records</p> <table border="1" data-bbox="895 577 1342 712"> <tr><td>APPLE</td><td>ORANGE</td><td>GRAPE</td><td>LEMON</td><td>PEACH</td></tr> <tr><td>60</td><td>60</td><td>50</td><td>40</td><td>80</td></tr> <tr><td>110</td><td>110</td><td>85</td><td>60</td><td>120</td></tr> <tr><td>250</td><td>220</td><td>240</td><td>220</td><td>240</td></tr> </table> <p style="text-align: right;">Data</p>	APPLE	60	110	250	ORANGE	60	110	220	GRAPE	50	85	240	LEMON	40	60	220	PEACH	80	120	240	APPLE	ORANGE	GRAPE	LEMON	PEACH	60	60	50	40	80	110	110	85	60	120	250	220	240	220	240				
APPLE	60	110	250																																										
ORANGE	60	110	220																																										
GRAPE	50	85	240																																										
LEMON	40	60	220																																										
PEACH	80	120	240																																										
APPLE	ORANGE	GRAPE	LEMON	PEACH																																									
60	60	50	40	80																																									
110	110	85	60	120																																									
250	220	240	220	240																																									
Add record name	<p>Set how to handle the first column (or first line) in the CSV/BIN file.</p> <ul style="list-style-type: none"> <li>Unselected The first column is handled as data.</li> </ul> <table border="1" data-bbox="935 824 1249 981"> <tr><td>60</td><td>110</td><td>250</td></tr> <tr><td>60</td><td>110</td><td>220</td></tr> <tr><td>50</td><td>85</td><td>240</td></tr> <tr><td>40</td><td>60</td><td>220</td></tr> <tr><td>80</td><td>120</td><td>240</td></tr> </table> <ul style="list-style-type: none"> <li>Selected The first column is handled as a record name (2 to 255).</li> </ul> <table border="1" data-bbox="927 1066 1353 1223"> <tr><td>APPLE</td><td>60</td><td>110</td><td>250</td></tr> <tr><td>ORANGE</td><td>60</td><td>110</td><td>220</td></tr> <tr><td>GRAPE</td><td>50</td><td>85</td><td>240</td></tr> <tr><td>LEMON</td><td>40</td><td>60</td><td>220</td></tr> <tr><td>PEACH</td><td>80</td><td>120</td><td>240</td></tr> </table>	60	110	250	60	110	220	50	85	240	40	60	220	80	120	240	APPLE	60	110	250	ORANGE	60	110	220	GRAPE	50	85	240	LEMON	40	60	220	PEACH	80	120	240									
60	110	250																																											
60	110	220																																											
50	85	240																																											
40	60	220																																											
80	120	240																																											
APPLE	60	110	250																																										
ORANGE	60	110	220																																										
GRAPE	50	85	240																																										
LEMON	40	60	220																																										
PEACH	80	120	240																																										
Add title to data	<p>Set how to handle the first line (or first column) in the CSV file.</p> <ul style="list-style-type: none"> <li>Unselected The first line is handled as data.</li> </ul> <table border="1" data-bbox="935 1335 1353 1485"> <tr><td>APPLE</td><td>60</td><td>110</td><td>250</td></tr> <tr><td>ORANGE</td><td>60</td><td>110</td><td>220</td></tr> <tr><td>GRAPE</td><td>50</td><td>85</td><td>240</td></tr> <tr><td>LEMON</td><td>40</td><td>60</td><td>220</td></tr> <tr><td>PEACH</td><td>80</td><td>120</td><td>240</td></tr> </table> <ul style="list-style-type: none"> <li>Selected The first line is handled as the title.</li> </ul> <table border="1" data-bbox="922 1570 1382 1760"> <tr><td></td><td>Agitation time</td><td>Sterilization time</td><td>Cooling time</td></tr> <tr><td>APPLE</td><td>60</td><td>110</td><td>250</td></tr> <tr><td>ORANGE</td><td>60</td><td>110</td><td>220</td></tr> <tr><td>GRAPE</td><td>50</td><td>85</td><td>240</td></tr> <tr><td>LEMON</td><td>40</td><td>60</td><td>220</td></tr> <tr><td>PEACH</td><td>80</td><td>120</td><td>240</td></tr> </table>	APPLE	60	110	250	ORANGE	60	110	220	GRAPE	50	85	240	LEMON	40	60	220	PEACH	80	120	240		Agitation time	Sterilization time	Cooling time	APPLE	60	110	250	ORANGE	60	110	220	GRAPE	50	85	240	LEMON	40	60	220	PEACH	80	120	240
APPLE	60	110	250																																										
ORANGE	60	110	220																																										
GRAPE	50	85	240																																										
LEMON	40	60	220																																										
PEACH	80	120	240																																										
	Agitation time	Sterilization time	Cooling time																																										
APPLE	60	110	250																																										
ORANGE	60	110	220																																										
GRAPE	50	85	240																																										
LEMON	40	60	220																																										
PEACH	80	120	240																																										
Delimiter (Comma, Tab, Period *2, Semicolon)	This setting is only available when [CSV] is selected for [File Type] on the [Standard Operation] tab window. Select the character for delimiting data.																																												
Number of Records (1 to 32767)	This setting is only available when [File-based transfer] is selected for [Data to Transfer] on the [Standard Operation] tab window. Set the number of records per file.																																												
Number of Data (1 to 4096)	Set the number of data entries on the first line (or first column) (per record) in the CSV/BIN file.																																												

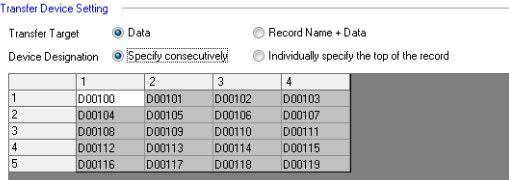
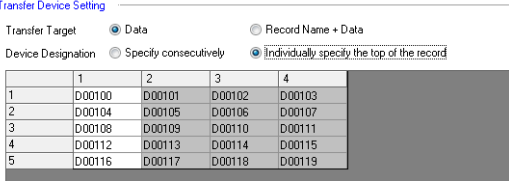
Item	Description	
Data Type (DEC/DEC-/HEX/OCT/BIN/CHAR/BCD/FLOAT)	Set the data format.	
Data Length (1-Word/2-Word)		
Decimal Point (0 to 32)		
Characters (2 to 255)		
Text Process (LSB → MSB)		
Transfer Target	This setting is only available when the [Add record name] checkbox is selected.	
	Data	Only transfer data.
	Record Name + Data	Transfer record names and data.
Device Designation	This setting is only available when [File-based transfer] is selected for [Data to Transfer] on the [Standard Operation] tab window.	
	Specify consecutively	Specify the top device memory address only. The number of bits required for the data is assigned consecutively.  
	Individually specify the top of the record	A top device memory address for each record in the file can be specified.  
V8 Compatible Setting	The automatically converted settings when a V8 recipe screen is converted.	

\*1 This setting is only available when [CSV] is selected for [File Type] on the [Standard Operation] tab window.

\*2 The decimal point is indicated using a comma for German, Italian, French and other relevant languages. For this reason, a period character may be used as the delimiter in CSV files. Note that when editing this data in Excel, the relevant option must be changed for the display format.

## [Recipe Data] Tab Window

Item	Description	
Create File	Select when creating a new CSV or BIN file.	
	Overwrite	Save the created file to an existing file.
	Save As	Save the created file using a different filename. The save destination is not limited to the storage device drive and can be changed to any location on the PC.
	Page	Switch the screen for editing.
	Interface Language	Switch the language for editing.
File Editing	Select when loading an existing CSV or BIN file.	
	Storage Drive Select	Select the drive of the SD card/USB flash drive connected to the PC.
	Storage Target Folder	The folder specified on the [Standard Operation] tab window is displayed automatically.
	File List	The files in the specified folder are displayed.
	Edit	Select a CSV/BIN file displayed under [File List] and click the [Edit] button. The file is loaded into the editing window on the right.
	Copy	Select a CSV/BIN file displayed under [File List] and click the [Copy] button. This makes a copy of the file.
	Delete	Select a CSV/BIN file displayed under [File List] and click the [Delete] button. This deletes the file.
	Rename	Select the CSV/BIN file displayed under [File List] and click the [Rename] button. The file name can be changed.
Edit a file in another folder	Edit a file in a folder other than the storage target folder. Click to display a window for specifying the folder.	
Newest File	Select when loading an existing CSV or BIN file that was used recently.	

## [Transfer Command] Tab Window

Item	Description																	
Add Transfer Condition	Specify the operation to perform and trigger bit to use when transferring the recipe.																	
PLC → MONITOUCH/MONITOUCH → PLC	Select [PLC → MONITOUCH] to store the data on the PLC onto an SD card. Select [MONITOUCH → PLC] to transfer the data on an SD card to the PLC.																	
Device	Specify the trigger bit used for outputting transfer commands.																	
Trigger Select *	The timing of the transfer command trigger can be selected. <ul style="list-style-type: none"> <li>Transfer when bit ON</li> <li>Transfer when bit OFF</li> </ul>																	
Device Setting	Select this checkbox to prohibit recipe transfer operations. Turning this bit ON prevents execution of transfer even if a recipe is selected and a transfer command is issued.																	
Use Info Output Device	Select this checkbox to check the state of recipe transfer operations on the specified device memory address. Information is divided across different bit numbers. Refer to the following table for details. <table border="1" style="margin-left: 20px;"> <thead> <tr> <th>Device</th> <th>Bit No.</th> <th>State</th> </tr> </thead> <tbody> <tr> <td rowspan="5">n</td> <td>0</td> <td>Transfer error 0: No error 1: Transfer error</td> </tr> <tr> <td>12</td> <td>MONITOUCH → PLC transfer in progress 1: Transferring (changes to 0 when transfer is complete)</td> </tr> <tr> <td>13</td> <td>PLC → MONITOUCH transfer in progress 1: Transferring (changes to 0 when transfer is complete)</td> </tr> <tr> <td>14</td> <td>MONITOUCH → PLC transfer complete 1: Transfer complete (must be cleared manually after checking)</td> </tr> <tr> <td>15</td> <td>PLC → MONITOUCH transfer complete 1: Transfer complete (must be cleared manually after checking)</td> </tr> <tr> <td>n+1</td> <td>-</td> <td>External media error 4: Media disconnected 12: Writing error 16: Reading error</td> </tr> </tbody> </table>	Device	Bit No.	State	n	0	Transfer error 0: No error 1: Transfer error	12	MONITOUCH → PLC transfer in progress 1: Transferring (changes to 0 when transfer is complete)	13	PLC → MONITOUCH transfer in progress 1: Transferring (changes to 0 when transfer is complete)	14	MONITOUCH → PLC transfer complete 1: Transfer complete (must be cleared manually after checking)	15	PLC → MONITOUCH transfer complete 1: Transfer complete (must be cleared manually after checking)	n+1	-	External media error 4: Media disconnected 12: Writing error 16: Reading error
Device	Bit No.	State																
n	0	Transfer error 0: No error 1: Transfer error																
	12	MONITOUCH → PLC transfer in progress 1: Transferring (changes to 0 when transfer is complete)																
	13	PLC → MONITOUCH transfer in progress 1: Transferring (changes to 0 when transfer is complete)																
	14	MONITOUCH → PLC transfer complete 1: Transfer complete (must be cleared manually after checking)																
	15	PLC → MONITOUCH transfer complete 1: Transfer complete (must be cleared manually after checking)																
n+1	-	External media error 4: Media disconnected 12: Writing error 16: Reading error																
Output Transfer File No.	This setting is only available when [File-based transfer] is selected for [Data to Transfer] and [File Number Designation] is selected for [Storage Target File] on the [Standard Operation] tab window. Select this checkbox to specify a device memory address. The transferred file number can be output.																	
Output Transfer File Name	This setting is only available when [File-based transfer] is selected for [Data to Transfer] and [File Name Designation] is selected for [Storage Target File] on the [Standard Operation] tab window. Select this checkbox to specify a device memory address. The transferred file name can be output using the relevant number of characters.																	
Output Transfer Record No.	This setting is only available when [Record-based transfer] is selected for [Data to Transfer] and [Record Number Designation] is selected for [Storage Target File] on the [Standard Operation] tab window. Select this checkbox to specify a device memory address. The transferred record number can be output.																	
Output Transfer Record Name	This setting is only available when [Record-based transfer] is selected for [Data to Transfer] and [Record Name Designation] is selected for [Storage Target File] on the [Standard Operation] tab window. Select this checkbox to specify a device memory address. The transferred record name can be output using the relevant number of characters.																	

\* Operation when MONITOUCH is starting up  
Transfer is executed when the trigger bit is ON or OFF during startup.

## 15.9 Switch Operated Functions

### 15.9.1 Switch Types

Operation	Switch Function	Attached Setting	Details of Operation
Filter	Recipe Data Save Recipe Data Load Recipe Data Delete	Select the [Select at the time of execution] checkbox for [File Selection]/[Record Selection].	Filter and display filenames or record names for when selecting a recipe.
New	Recipe Data Save	Select the [Select at the time of execution] checkbox for [File Selection]/[Record Selection].	Create new recipe data by naming a file or record and save to an SD card.
Save	Recipe Data Save	Select the [Select at the time of execution] checkbox for [File Selection]/[Record Selection].	Write data on a PLC to the recipe on an SD card. (Filter and display filenames or record names for when selecting a recipe.)
	Recipe Data Save	Select [Specify the number] or [Specify the name] for [File Selection]/[Record Selection].	Write data on a PLC to the recipe (file/record specified with the switch) on an SD card.
Load	Recipe Data Load	Select the [Select at the time of execution] checkbox for [File Selection]/[Record Selection].	Load recipe data on an SD card to a PLC. (Filter and display filenames or record names for when selecting a recipe.)
	Recipe Data Load	Select [Specify the number] or [Specify the name] for [File Selection]/[Record Selection].	Load recipe data (file/record specified with the switch) on an SD card to a PLC.
Delete	Recipe Data Delete	Select the [Select at the time of execution] checkbox for [File Selection].	Delete the recipe file on an SD card. (Filter and display filenames or record names for when selecting a recipe.)
	Recipe Data Delete	Select [Specify the number] or [Specify the name] for [File Selection].	Delete the specified recipe file on an SD card.
	Recipe Data Delete	Select the [Select at the time of execution] checkbox for [Record Selection].	Empty (delete) a record on an SD card. (Filter and display record names for when selecting a recipe.)
	Recipe Data Delete	Select [Specify the number] or [Specify the name] for [Record Selection].	Empty (delete data) the specified record on an SD card.

## Filter

### Target/Conditions

Filter target	Filenames and record names
Filter length	Max. 64 characters (both two-byte and one-byte)
Filter conditions *	Equal to/Not equal to/Begin with/Not begin with/End with/Not end with/Include/Not include
Location of execution	Executable by pressing switches with [Function] set to [Recipe Data Save], [Recipe Data Load], or [Recipe Data Delete].

- \* Not case-sensitive for file name targets.  
Case-sensitive for record names.

## Operating Procedure

The operating procedure is explained using the example of pressing a [Recipe Save Data] switch.

1. Set the recipe number in the editor and transfer a [Recipe Data Save] switch with the [Select at the time of execution] checkbox selected for [File Selection]/[Record Selection] to the V9 series unit in advance.
2. Press the [Recipe Save Data] switch on the V9 series unit. The following list window is displayed.

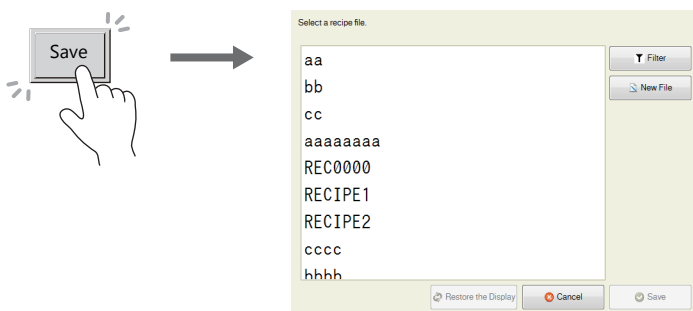

3. Press the [Filter] button to display the following text filtering window.  
Enter the first few characters of the filename or record name.
- \* Press the text field to automatically display the system keyboard. Use this keyboard to enter text.

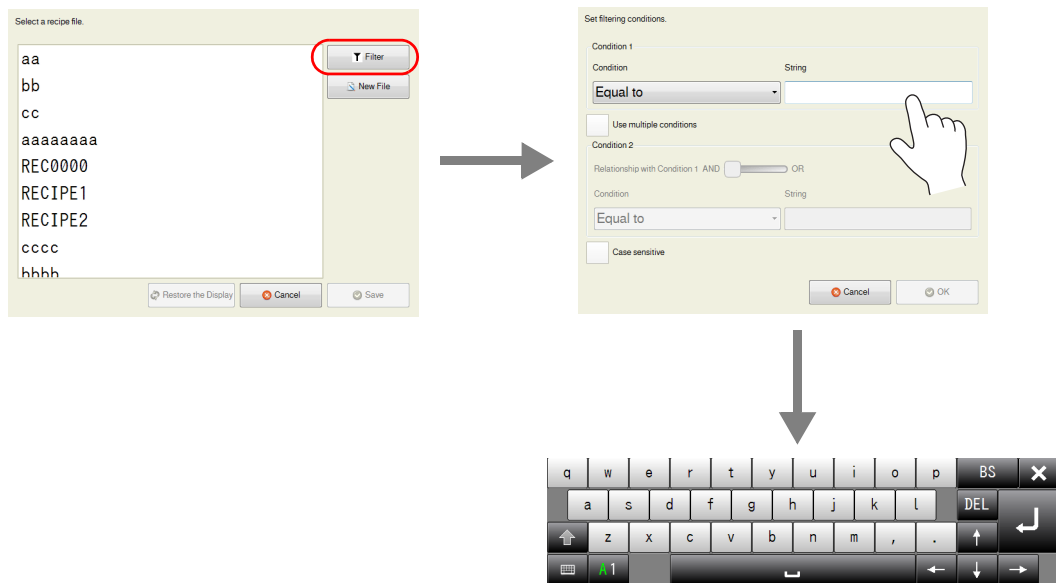

4. Selecting the [Include] filter condition and pressing the [OK] button displays a list of files or records with names that contain the entered text. (When the entire list cannot be viewed in the window at once, hidden items can be checked by scrolling.)



5. Find the target file or record, select it, and press [Save]. The following confirmation message is displayed. Press [Yes] to overwrite.



# New

## File-Based Targets

1. Set the recipe number in the editor and transfer a [Recipe Save Data] switch with the [Select at the time of execution] checkbox selected for [File Selection] to the V9 series unit in advance.
2. Press the [Recipe Save Data] switch on the V9 series unit. The window shown below is displayed.

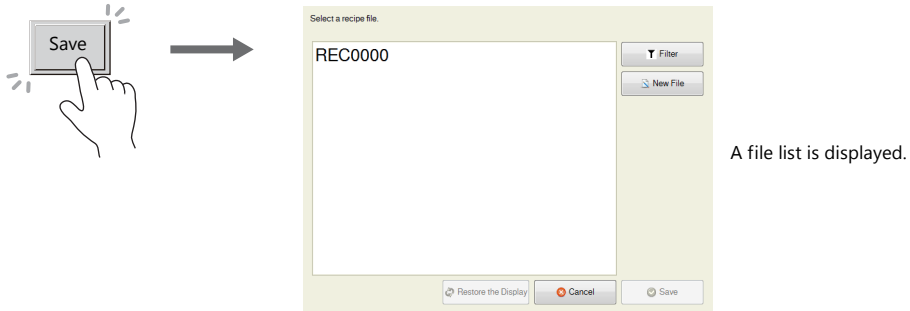

3. Click the [New File] button. The window for entering a new recipe name is displayed.

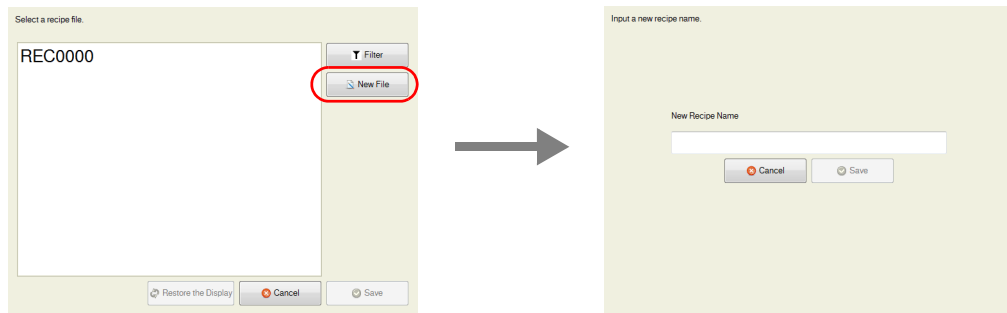

4. Press the text field to automatically display the system keyboard. Use this keyboard to enter the name of the new file to create.

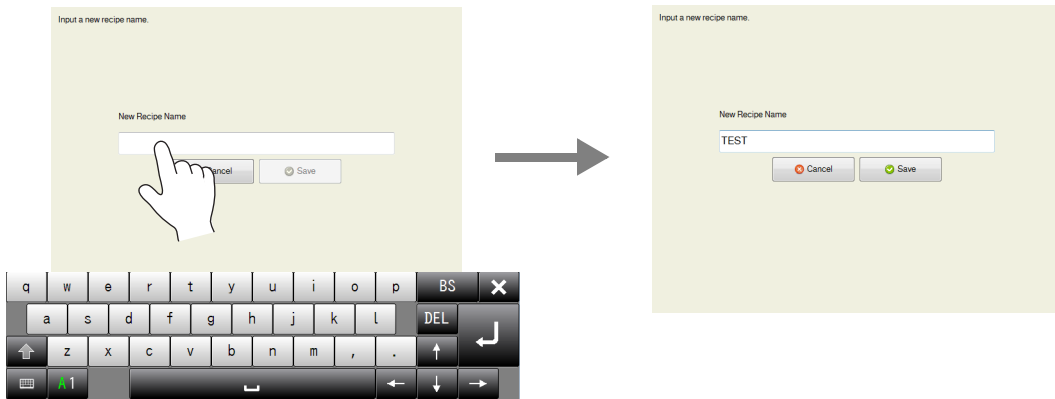

- 5. Press the [Save] button to create a new file.  
Press the [Recipe Load Data] switch to display a list that contains the newly created file.

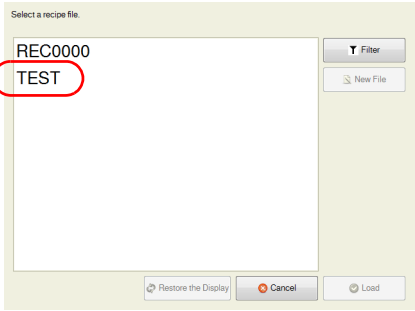

### Record-Based Targets

When the target is a record, select [Record Name Designation] for [Transfer Record] in the recipe settings in advance.

- 1. Set the recipe number in the editor and transfer a switch with the [Select at the time of execution] checkbox selected for [Record Selection] to the V9 series unit in advance.
- 2. Press the [Recipe Save Data] switch on the V9 series unit. The window shown below is displayed.

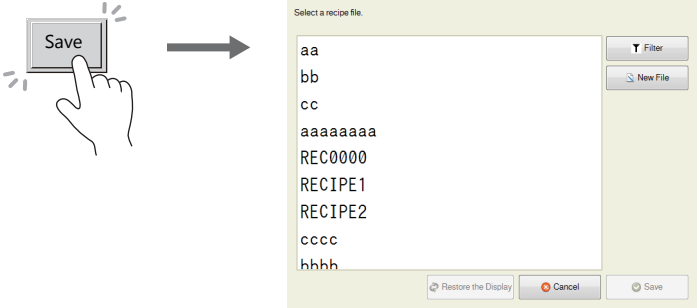

- 3. Click the [New File] button. The window for entering a new recipe name is displayed.

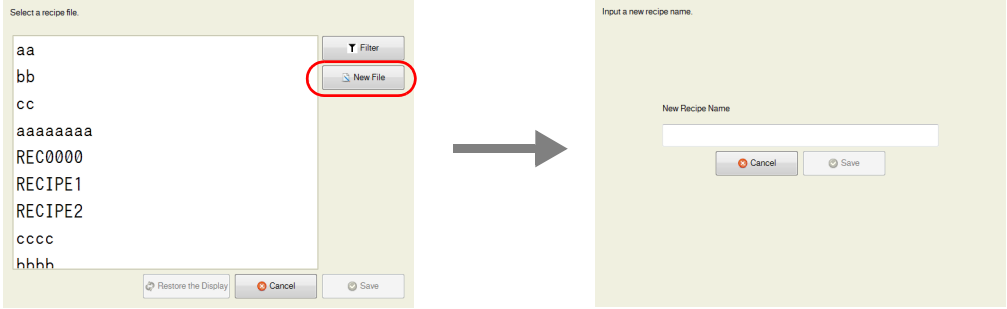



4. Press the text field to automatically display the system keyboard. Use this keyboard to enter the name of the new record to create.

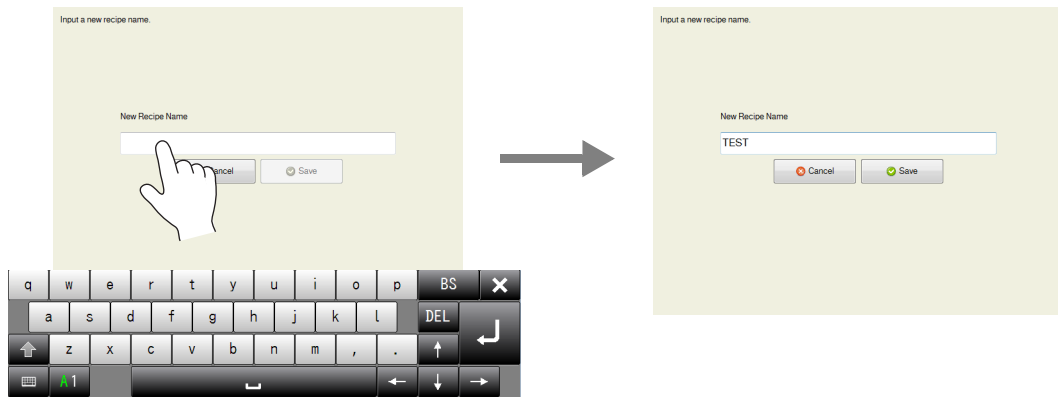

Press the text field to display the system keyboard.

5. Press the [Save] button to create a new record.

## 15.10 Specifications

Number of recipes	256 *1
Number of files	No limit (up to the capacity of the target storage device)
Number of records per file	32767
Number of data entries per record	4096 (number of words per record: 65535)
Number of folder name characters	Maximum of 255 characters (one-byte) for the full path name *2
Number of filename characters	Maximum of 64 characters (one-byte) or 32 characters (two-byte) *2
Number of record name characters	Maximum of 255 characters (one-byte) *2
Number of transferable words	No limitation *3
Number of recipes executable at the same time	Maximum of 4 recipes *4
Number of files transferable at the same time	1
Number of records transferable at the same time	When [Record-based transfer] is set for [Data to Transfer]: 2 When [File-based transfer] is set for [Data to Transfer]: Number set for [Number of Records] on the [File Format] tab window (max. 32767 records).

- \*1 Check how many recipes are currently registered by clicking [Tool] → [List of Memory Use] or [View] → [Project]. Delete registered recipes by first displaying the [Project] view window via [View] → [Project], and then clicking [Recipe] via [Add/Delete Other Settings] under [System Setting]. Double-click on [Recipe] to display the current recipes in the list. Select the recipes for deletion and click the [Delete] button.

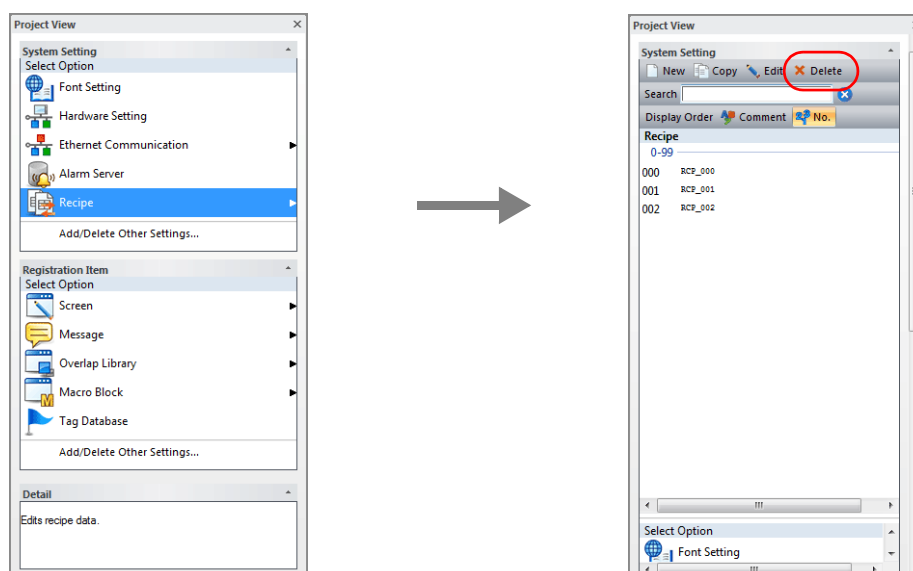

- \*2 Not case-sensitive for one-byte characters.  
 \*3 Note that if 4096 words is exceeded, transfer processing is executed by internally dividing the number of records into units of 4096 words.  
 \*4 Execution of a fifth recipe does not generate an error. The data of the fifth recipe is put on standby until the execution of any one of the four recipes is completed, and the recipe data on standby is executed.

## Notes

- Global operations and local operations cannot be executed at the same time on the same recipe number.
- When the screen is changed during recipe operation:
  - Global: Not affected.
  - Local: Screen is changed after transfer processing is complete.
- When record data is deleted, the record data is written as empty data.
- If the data format is a character string (including the record name), the recipe data cannot be read or written correctly if the language in the file (character code) and the language set on MONITOUCH do not match.

## Recipe Parts

- Click [Parts] → [Others] → [Recipe] to place a recipe part on the screen.  
This part is a replacement for the recipe display used by the V8 series. Converting a V8 series screen program with recipe display parts on the screen to a V9 series screen program will automatically convert it to this item.
- Compatibility is maintained with recipe settings for this recipe part with the [V8 Compatible Setting] at [System Setting] → [Recipe] (No.) → [File Format].

# **16 Print**

---

16.1 Overview

16.2 Hard copy

16.3 Printing Data Sheets

16.4 Connecting to a Sato MR-400 Barcode Printer

# 16.1 Overview

When the V9 series is operating in RUN mode, the displayed screen and the internal buffer information can be printed from a connected printer.

- Hard copy  
Print the displayed screen.

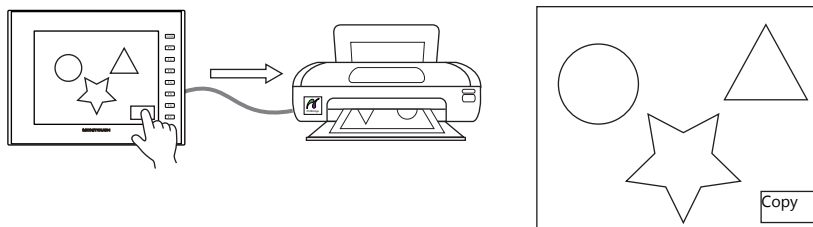

For details, refer to "16.2 Hard copy" page 16-15.

- Printing logs  
Print collected log data.

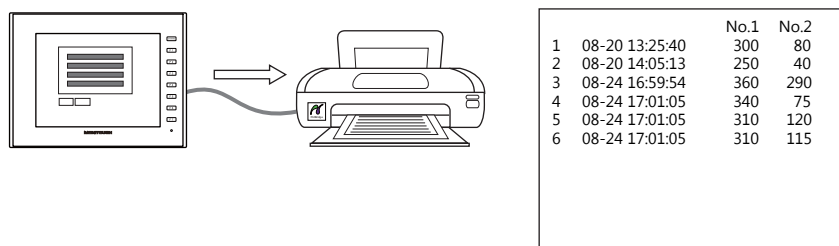

For details, refer to "Log Printing" page 7-29.

- Data sheet print  
- Print data registered as a data sheet.

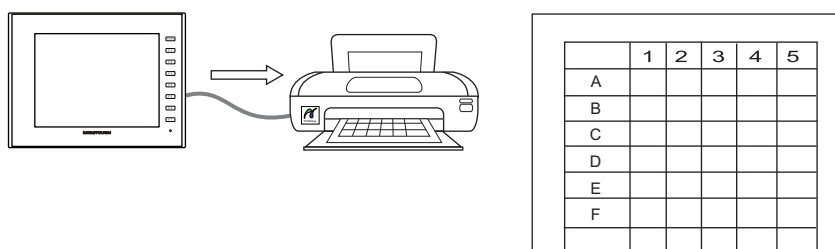

- Data registered as a data sheet is output to a storage device in PDF file format.

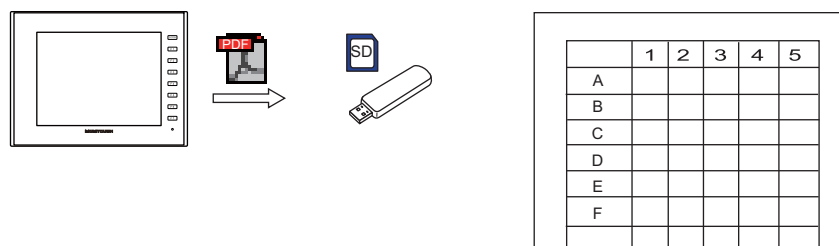

For details, refer to "16.3 Printing Data Sheets" page 16-17.

## 16.1.1 Compatible Printers

The following printers can be connected to the V9 series.

Editor Setting	Supported Models	V9 Connection Port
EPSON ESC/P-R	EPSON printers that support "ESC/P-R" control codes	USB-A
PictBridge	PictBridge-compatible printer	USB-B
PR201 Monochrome	PC-PR201 series models with which printing from MS-DOS is possible	MJ1 MJ2 USB-A
PR201 Color		
ESC-P Monochrome	MS-DOS-compatible printer models ESC/P24-J84, ESC/P-J84, and ESC/P Super	
ESC-P Color		
CBM292 / 293	Citizen Systems Line Thermal Printer	
MR - 400	Sato MR-400 series barcode printer	

### List of compatible printers



For a list of compatible printer models, visit our website (<http://www.monitouch.com>).

### Printable Items

The table below shows the items printable by each printer.

Printable Items	ESC/P-R	PictBridge	PR201 ESC-P	CBM292/293	MR-400
Screen hard copy	○ *1	○ *1	○ *3	×	×
Printing logs	○	○	○	○	×
Data sheet print	○ *2	○	○	○	×
Data sheet print (expanded)	○	○	×	×	×
Printing using the "OUT_PR" macro command	○	○	○	○	×
Printing using the "MR_REG"/"MR_OUT" macro command	×	×	×	×	○

\*1 A color or monochrome hard copy can be designated with the system device memory (\$s1007).

\$s1007	Hard copy
0	Color (32-k colors)
1	Grayscale

\*2 Landscape printing on A4/15-inch paper is not supported.  
Data is printed in portrait orientation regardless of the paper setting.

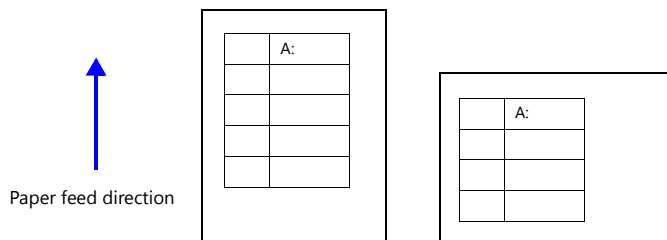

\*3 When PR201 Color or ESC-P Color is selected, printing is performed using 16 colors.

## 16.1.2 EPSON Printers that Support “ESC/P-R” Control Codes

EPSON printers that support “ESC/P-R” control codes can be connected to the V9 series.

 For information on compatible models, visit our website (<http://www.monitouch.com>).

### Connection

#### USB-A port connection

- Connect the USB-A port of the V9 series unit to the USB port of the printer with a commercially available USB cable.

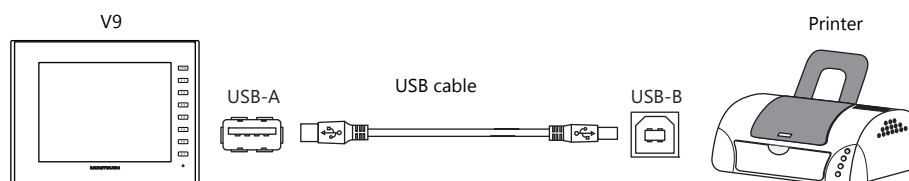

### Hardware Settings

Configure the [System Setting] → [Hardware Setting] → [Printer] settings.

#### Printer model

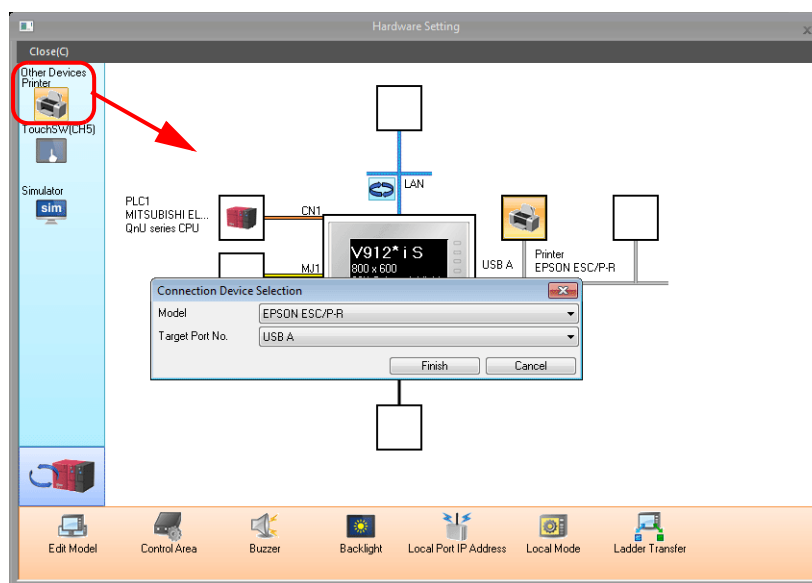

Item	Description
Model	Select the connected printer. EPSON ESC/P-R
Target Port No.	Select the port where the printer cable is connected. USB-A: Connect a printer using a commercially available USB cable.

## Printer properties

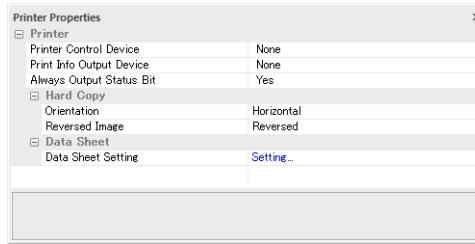

Item	Description																																
Printer Control Device (Yes/None)	<p>When using a device memory for printer control, printing of screen hard copies and data sheets can be performed by setting the bit from "0" to "1".</p> <p>MSB <span style="float: right;">LSB</span></p> <table border="1" style="width: 100%; text-align: center;"> <tr> <td>15</td><td>14</td><td>13</td><td>12</td><td>11</td><td>10</td><td>09</td><td>08</td><td>07</td><td>06</td><td>05</td><td>04</td><td>03</td><td>02</td><td>01</td><td>00</td> </tr> <tr> <td>0</td><td>0</td><td>0</td><td>0</td><td>0</td><td>0</td><td>0</td><td>0</td><td>0</td><td>0</td><td>0</td><td>0</td><td>0</td><td>0</td><td></td><td></td> </tr> </table> <p style="text-align: right;">0 → 1: Screen hard copy <input type="checkbox"/></p> <p style="text-align: right;">0 → 1: Data sheet output <input type="checkbox"/></p>	15	14	13	12	11	10	09	08	07	06	05	04	03	02	01	00	0	0	0	0	0	0	0	0	0	0	0	0	0	0		
15	14	13	12	11	10	09	08	07	06	05	04	03	02	01	00																		
0	0	0	0	0	0	0	0	0	0	0	0	0	0																				
Printer Info Output Device (Yes/None)	<p>When using a device memory for outputting printer information, the printer state is output to the specified address.</p> <p>MSB <span style="float: right;">LSB</span></p> <table border="1" style="width: 100%; text-align: center;"> <tr> <td>15</td><td>14</td><td>13</td><td>12</td><td>11</td><td>10</td><td>09</td><td>08</td><td>07</td><td>06</td><td>05</td><td>04</td><td>03</td><td>02</td><td>01</td><td>00</td> </tr> <tr> <td>0</td><td>0</td><td>0</td><td>0</td><td>0</td><td>0</td><td>0</td><td>0</td><td>0</td><td>0</td><td>0</td><td>0</td><td>0</td><td>0</td><td></td><td></td> </tr> </table> <p style="text-align: right;">0: End (standby) <input type="checkbox"/></p> <p style="text-align: right;">1: Transferring data for printing <input type="checkbox"/></p> <p style="text-align: right;">0: Not busy state <input type="checkbox"/></p> <p style="text-align: right;">1: Busy state <input type="checkbox"/></p>	15	14	13	12	11	10	09	08	07	06	05	04	03	02	01	00	0	0	0	0	0	0	0	0	0	0	0	0	0	0		
15	14	13	12	11	10	09	08	07	06	05	04	03	02	01	00																		
0	0	0	0	0	0	0	0	0	0	0	0	0	0																				
Always Output Status Bit (Yes/None)	<p>When the V9 series receives a print command, "0 → 1" is output at the start of data transmission and "1 → 0" is output at the end of transmission. However, if the print data is minimal, the signal may not be output. Set to "Yes" when bit output is required regardless of the data size.</p> <p>The output area is shown below.</p> <ul style="list-style-type: none"> <li>• Bit 1 of the device memory for outputting printer information</li> <li>• Bit 0 of internal device memory \$s16</li> </ul> <p>\$s16</p> <p>MSB <span style="float: right;">LSB</span></p> <table border="1" style="width: 100%; text-align: center;"> <tr> <td>15</td><td>14</td><td>13</td><td>12</td><td>11</td><td>10</td><td>09</td><td>08</td><td>07</td><td>06</td><td>05</td><td>04</td><td>03</td><td>02</td><td>01</td><td>00</td> </tr> <tr> <td>0</td><td>0</td><td>0</td><td>0</td><td>0</td><td>0</td><td>0</td><td>0</td><td>0</td><td>0</td><td>0</td><td>0</td><td>0</td><td>0</td><td>0</td><td></td> </tr> </table> <p style="text-align: right;">0: End (standby) <input type="checkbox"/></p> <p style="text-align: right;">1: Transferring data for printing <input type="checkbox"/></p>	15	14	13	12	11	10	09	08	07	06	05	04	03	02	01	00	0	0	0	0	0	0	0	0	0	0	0	0	0	0	0	
15	14	13	12	11	10	09	08	07	06	05	04	03	02	01	00																		
0	0	0	0	0	0	0	0	0	0	0	0	0	0	0																			
Hard copy	<p>Reversed Image (Reversed, Normal)</p> <p>Reversed: White and black are reversed for printing. Normal: The exact state of the screen on the unit is printed.</p>																																
Data Sheet	<p>Data Sheet Setting</p> <p>Configure settings for data sheet printing. For details, refer to <a href="#">page 16-17</a>.</p>																																



## 16.1.3 PictBridge Printers

A PictBridge-compatible printer can be connected.

 For information on compatible models, visit our website (<http://www.monitouch.com>).

### Connection

#### USB-B port connection

Connect the USB-B port of the V9 series unit to the USB-A port of the printer with a commercially available USB cable.

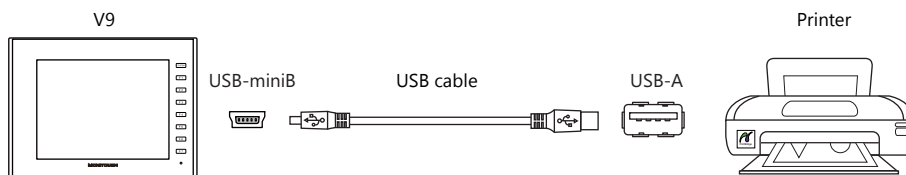

\* When transferring screen programs via the USB-B port, change the cable connection.

### Hardware Settings

Configure the [System Setting] → [Hardware Setting] → [Printer] settings.

#### Printer model

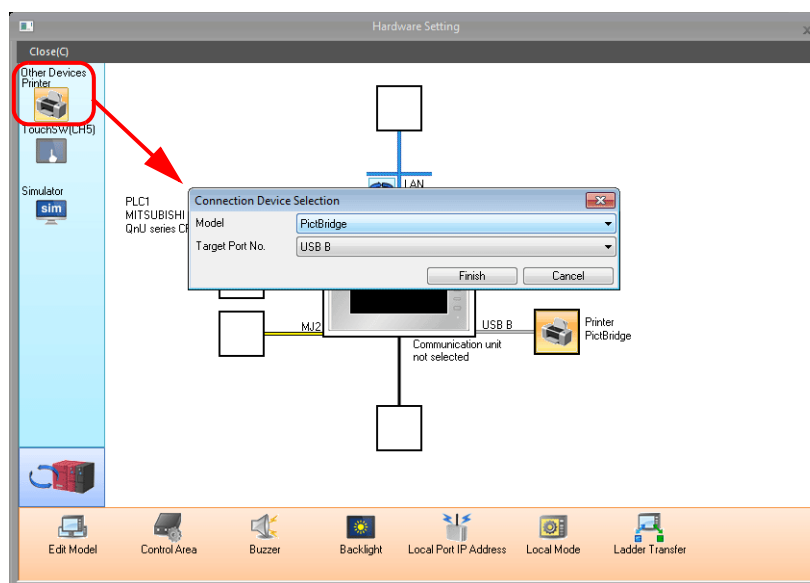

Item	Description
Model	PictBridge
Target Port No.	USB-B (automatically set when "PictBridge" is selected for [Model])

## Printer properties

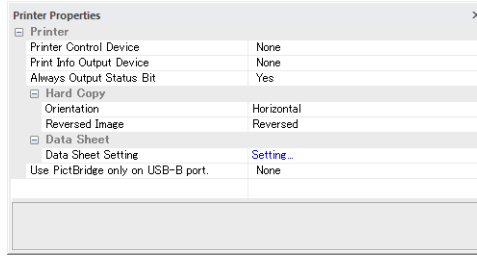

Item	Description																																
Printer Control Device (Yes/None)	<p>When using a device memory for printer control, printing of screen hard copies and data sheets can be performed by setting the bit from "0" to "1".</p> <p>MSB <span style="float: right;">LSB</span></p> <table border="1" style="margin-left: auto; margin-right: auto;"> <tr> <td>15</td><td>14</td><td>13</td><td>12</td><td>11</td><td>10</td><td>09</td><td>08</td><td>07</td><td>06</td><td>05</td><td>04</td><td>03</td><td>02</td><td>01</td><td>00</td> </tr> <tr> <td>0</td><td>0</td><td>0</td><td>0</td><td>0</td><td>0</td><td>0</td><td>0</td><td>0</td><td>0</td><td>0</td><td>0</td><td>0</td><td>0</td><td>0</td><td>0</td> </tr> </table> <p style="text-align: right;">                     0 → 1: Screen hard copy                      0 → 1: Data sheet output                 </p>	15	14	13	12	11	10	09	08	07	06	05	04	03	02	01	00	0	0	0	0	0	0	0	0	0	0	0	0	0	0	0	0
15	14	13	12	11	10	09	08	07	06	05	04	03	02	01	00																		
0	0	0	0	0	0	0	0	0	0	0	0	0	0	0	0																		
Printer Info Output Device (Yes/None)	<p>When using a device memory for outputting printer information, the printer state is output to the specified address.</p> <p>MSB <span style="float: right;">LSB</span></p> <table border="1" style="margin-left: auto; margin-right: auto;"> <tr> <td>15</td><td>14</td><td>13</td><td>12</td><td>11</td><td>10</td><td>09</td><td>08</td><td>07</td><td>06</td><td>05</td><td>04</td><td>03</td><td>02</td><td>01</td><td>00</td> </tr> <tr> <td>0</td><td>0</td><td>0</td><td>0</td><td>0</td><td>0</td><td>0</td><td>0</td><td>0</td><td>0</td><td>0</td><td>0</td><td>0</td><td>0</td><td>0</td><td>0</td> </tr> </table> <p style="text-align: right;">                     0: End (standby)                      1: Transferring data for printing                      0: Not busy state                      1: Busy state                 </p>	15	14	13	12	11	10	09	08	07	06	05	04	03	02	01	00	0	0	0	0	0	0	0	0	0	0	0	0	0	0	0	0
15	14	13	12	11	10	09	08	07	06	05	04	03	02	01	00																		
0	0	0	0	0	0	0	0	0	0	0	0	0	0	0	0																		
Always Output Status Bit (Yes/None)	<p>When the V9 series receives a print command, "0 → 1" is output at the start of data transmission and "1 → 0" is output at the end of transmission. However, if the print data is minimal, the signal may not be output. Set to "Yes" when bit output is required regardless of the data size.</p> <p>The output area is shown below.</p> <ul style="list-style-type: none"> <li>Bit 1 of the device memory for outputting printer information</li> <li>Bit 0 of internal device memory \$s16</li> </ul> <p>\$s16</p> <p>MSB <span style="float: right;">LSB</span></p> <table border="1" style="margin-left: auto; margin-right: auto;"> <tr> <td>15</td><td>14</td><td>13</td><td>12</td><td>11</td><td>10</td><td>09</td><td>08</td><td>07</td><td>06</td><td>05</td><td>04</td><td>03</td><td>02</td><td>01</td><td>00</td> </tr> <tr> <td>0</td><td>0</td><td>0</td><td>0</td><td>0</td><td>0</td><td>0</td><td>0</td><td>0</td><td>0</td><td>0</td><td>0</td><td>0</td><td>0</td><td>0</td><td>0</td> </tr> </table> <p style="text-align: right;">                     0: End (standby)                      1: Transferring data for printing                 </p>	15	14	13	12	11	10	09	08	07	06	05	04	03	02	01	00	0	0	0	0	0	0	0	0	0	0	0	0	0	0	0	0
15	14	13	12	11	10	09	08	07	06	05	04	03	02	01	00																		
0	0	0	0	0	0	0	0	0	0	0	0	0	0	0	0																		
Hard copy	<p>Orientation (Horizontal/Vertical)</p> <p>Select the orientation of the screen image printed on paper. When [Vertical] is selected, the image for printing is rotated 90 degrees on the paper. * This setting is disabled for edit models of SVGA (800 × 600 pixels) or higher.</p> <ul style="list-style-type: none"> <li>Hard copy example</li> </ul> <div style="display: flex; justify-content: space-around; align-items: center;"> <div style="text-align: center;"> <p>Horizontal</p> </div> <div style="text-align: center;"> <p>Vertical</p> </div> </div>																																
	<p>Reversed Image (Reversed/Normal)</p> <p>Reversed: White and black are reversed for printing. Normal: The exact state of the screen on the unit is printed.</p>																																
Data Sheet	Data Sheet Setting	Configure settings for data sheet printing. For details, refer to <a href="#">page 16-17</a> .																															
Use PictBridge only on USB-B port (Yes/None)	<p>Select "Yes" when using the USB-B port to connect to a PictBridge printer during operation in RUN mode. When transferring screen programs via the USB-B port, switch to Local mode.</p>																																

## Print Size

The print size varies depending on the item to be printed and the paper setting.

### Screen hard copy

- The paper size is fixed to "A4".
- The print start position and print size cannot be changed. The actual margins, however, may differ from the one shown below depending on the printer used.
- When [Vertical] (portrait) is selected (unit: mm):  
The landscape output is available when the printer supports A4 paper and 2-up printing. If not supported, printing is performed in the landscape orientation.

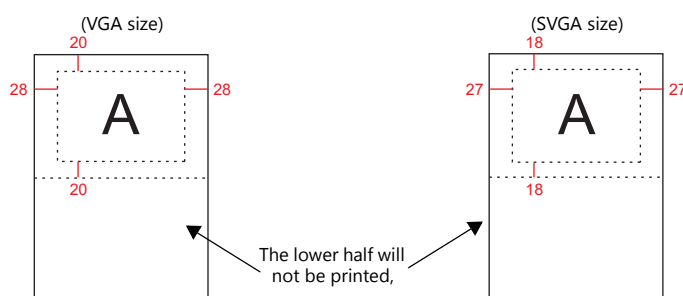

- When [Horizontal] (landscape) is selected (unit: mm):  
The landscape output is available when the printer supports A4 paper and 1-up printing. If not supported, printing is performed in the orientation set on the printer.

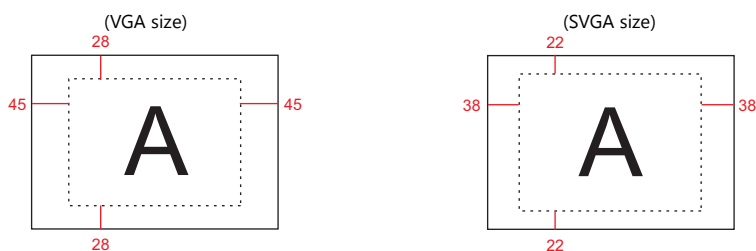

### Printing logs

- Printing is fixed to "A4 vertical (portrait)". If a line cannot be held within the paper width, the remaining section will be printed while wrapping around and going down to the next line.
- The print start position and print size cannot be changed. The actual margins, however, may differ from the one shown below depending on the printer used.

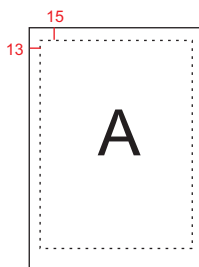

## Data sheet print

- Printing orientation is fixed to “portrait”.
- Select the printer in the [Hardware Setting] window, select [Setting] next to [Data Sheet Setting], and select a paper size for [Paper Size]. If a selected print size is different from the paper size set for the printer, printing cannot be performed correctly. (Data outside the printing area is not printed.)
- The print start position and print size cannot be changed. The actual margins, however, may differ from those shown below depending on the printer used.

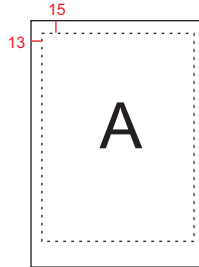

## Data sheet print (expanded)

- The print size is A4 only. Use a printer that handles A4 paper. If A4 paper is fed in landscape orientation or a selected paper size is different from the paper size set for the printer, printing cannot be performed correctly. (Data outside the printing area is not printed.)
- The print start position and print size cannot be changed. Note that margins will vary slightly between different printer models.
- For parts placed on an expanded data sheet screen, the [Show/Hide] setting takes effect. When a part should always be printed, select [Show] for the [Show/Hide] setting.

## Status Output

The status of the connection between the V9 series unit and a PictBridge printer is output to the internal device memory \$s1066.

Value	Description	Cause and Remedy
0	The PictBridge printer is not connected or it is in the normal state.	-
1	Printing in process using the PictBridge printer.	-
-1	Printer error (hardware related)	The cable is not connected. Check the USB cable connection.
		Check if the printer is out of order.
-2	Printer error (paper related)	The printer ran out of paper. Add paper.
		Paper is not correct. Set correct paper.
-3	Printer error (ink related) *	The ink is not set. Install an ink cartridge.
		The ink level is low. Install a new ink cartridge.

\* The error may be output as “-1” (printer error related to hardware) depending on the printer used.

## Notes

- Color printing is performed.
- Error handling varies depending on the printer model. For details, refer to the instruction manual for the printer.

## 16.1.4 PR201 and ESC-P Printers

The V9 series can connect to MS-DOS-compatible printers.

- MS-DOS-compatible printer models in the PR201 series
- MS-DOS-compatible printer models ESC/P24-J84, ESC/P-J84, and ESC/P Super

 For information on connectable models, visit our website at <http://www.monitouch.com>.

### Connection Method

#### USB-A port connection

- Connect the USB-A port of the V9 series unit to the parallel port of the printer with a USB-parallel conversion cable (commercially available).

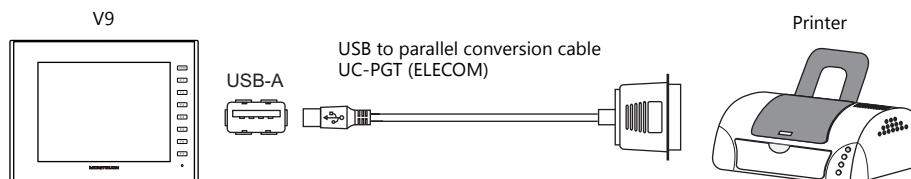

#### Serial connection (MJ1 or MJ2)

- Connect the MJ port of the V9 series unit with the serial port of the printer.

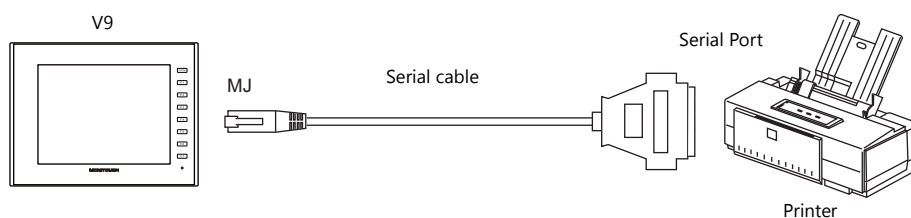

### Hardware Settings

Configure the [System Setting] → [Hardware Setting] → [Printer] settings.

#### Printer model

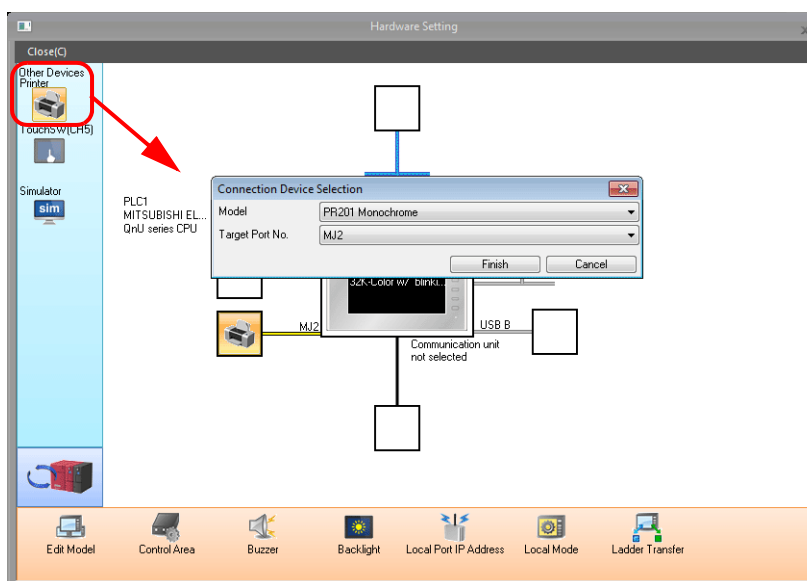

Item	Description
Model	Select the control code of the target printer from the following options: <ul style="list-style-type: none"> <li>• PR201 Monochrome</li> <li>• PR201 Color</li> <li>• ESC-P Monochrome</li> <li>• ESC-P Color</li> </ul>

Item	Description
Target Port No.	Select the port where the printer cable is connected. USB-A: Select this option when connecting to a parallel interface printer with a USB-parallel conversion cable (commercially available). MJ1/MJ2: Select this option when connecting to a printer equipped with a serial interface. Select either MJ1 or MJ2 on the V9 series unit.

## Printer properties

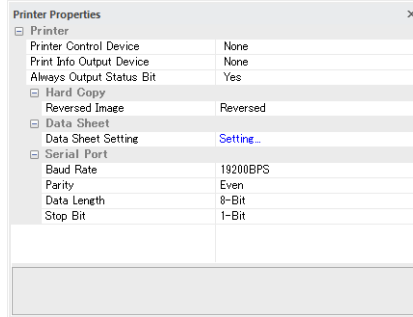

Item	Description																																
Printer Control Device (Yes/None)	When this setting is enabled and the bit is set to ON (0 → 1), screen images and data sheets can be printed out. MSB <span style="float: right;">LSB</span> <table border="1" style="width: 100%; text-align: center;"> <tr> <td>15</td><td>14</td><td>13</td><td>12</td><td>11</td><td>10</td><td>09</td><td>08</td><td>07</td><td>06</td><td>05</td><td>04</td><td>03</td><td>02</td><td>01</td><td>00</td> </tr> <tr> <td>0</td><td>0</td><td>0</td><td>0</td><td>0</td><td>0</td><td>0</td><td>0</td><td>0</td><td>0</td><td>0</td><td>0</td><td>0</td><td>0</td><td>0</td><td>0</td> </tr> </table> 0 → 1: Screen image output 0 → 1: Data sheet output	15	14	13	12	11	10	09	08	07	06	05	04	03	02	01	00	0	0	0	0	0	0	0	0	0	0	0	0	0	0	0	0
15	14	13	12	11	10	09	08	07	06	05	04	03	02	01	00																		
0	0	0	0	0	0	0	0	0	0	0	0	0	0	0	0																		
Printer Info Output Device (Yes/None)	When using a device memory for outputting printer information, the printer state is output to the specified address. MSB <span style="float: right;">LSB</span> <table border="1" style="width: 100%; text-align: center;"> <tr> <td>15</td><td>14</td><td>13</td><td>12</td><td>11</td><td>10</td><td>09</td><td>08</td><td>07</td><td>06</td><td>05</td><td>04</td><td>03</td><td>02</td><td>01</td><td>00</td> </tr> <tr> <td>0</td><td>0</td><td>0</td><td>0</td><td>0</td><td>0</td><td>0</td><td>0</td><td>0</td><td>0</td><td>0</td><td>0</td><td>0</td><td>0</td><td>0</td><td>0</td> </tr> </table> 0: End (standby) 1: Transferring print data 0: Not busy 1: Busy	15	14	13	12	11	10	09	08	07	06	05	04	03	02	01	00	0	0	0	0	0	0	0	0	0	0	0	0	0	0	0	0
15	14	13	12	11	10	09	08	07	06	05	04	03	02	01	00																		
0	0	0	0	0	0	0	0	0	0	0	0	0	0	0	0																		
Always Output Status Bit (Yes/None)	The V9 series outputs [0 → 1] when starting to transfer data upon receiving a print command, and outputs [1 → 0] upon finishing transfer. However, these signals may not be output if the print data is small. Set to "Yes" when bit output is required regardless of the data size. The output area is shown below. <ul style="list-style-type: none"> <li>• Bit 1 of the device memory for outputting printer information</li> <li>• Bit 0 of internal device memory \$s16</li> </ul> \$s16 MSB <span style="float: right;">LSB</span> <table border="1" style="width: 100%; text-align: center;"> <tr> <td>15</td><td>14</td><td>13</td><td>12</td><td>11</td><td>10</td><td>09</td><td>08</td><td>07</td><td>06</td><td>05</td><td>04</td><td>03</td><td>02</td><td>01</td><td>00</td> </tr> <tr> <td>0</td><td>0</td><td>0</td><td>0</td><td>0</td><td>0</td><td>0</td><td>0</td><td>0</td><td>0</td><td>0</td><td>0</td><td>0</td><td>0</td><td>0</td><td>0</td> </tr> </table> 0: End (standby) 1: Transferring print data	15	14	13	12	11	10	09	08	07	06	05	04	03	02	01	00	0	0	0	0	0	0	0	0	0	0	0	0	0	0	0	0
15	14	13	12	11	10	09	08	07	06	05	04	03	02	01	00																		
0	0	0	0	0	0	0	0	0	0	0	0	0	0	0	0																		

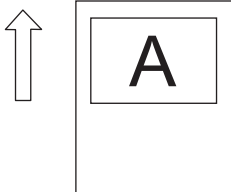
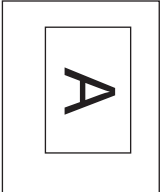
Item	Description
Hard Copy	<p>Select the orientation of the screen image printed on paper. When [Vertical] is selected, the image for printing is rotated 90 degrees on the paper.</p> <p>* This setting is disabled for edit models of SVGA (800 × 600 pixels) or higher.</p> <ul style="list-style-type: none"> <li>• Hard copy example</li> </ul> <div style="display: flex; justify-content: space-around; align-items: center;"> <div style="text-align: center;"> <p>Horizontal</p>  </div> <div style="text-align: center;"> <p>Vertical</p>  </div> </div>
	<p>Reversed Image (Reversed, Normal)</p> <p>Reversed: White and black are reversed for printing. Normal: The exact state of the screen on the unit is printed.</p>
Data Sheet	Data Sheet Setting
Serial Port *	Baud Rate
	Parity
	Data Length
	Stop Bit

\* This setting is only available when MJ1 or MJ2 is selected for [Target Port No].

## 16.1.5 CBM292/293 Printer

The V9 series can connect to CBM line thermal printers (Citizen).

 For information on connectable models, visit our website at <http://www.monitouch.com>.

### Connection Method

#### USB-A port connection

- Connect the USB-A port of the V9 series unit to the parallel port of the printer with a USB-parallel conversion cable (commercially available).

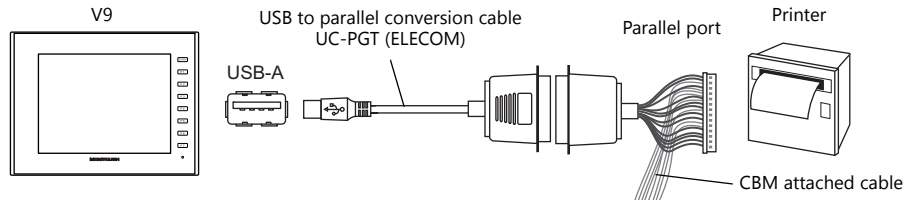

#### Serial connection (MJ1 or MJ2)

- Connect the MJ port of the V9 series unit with the serial port of the printer.

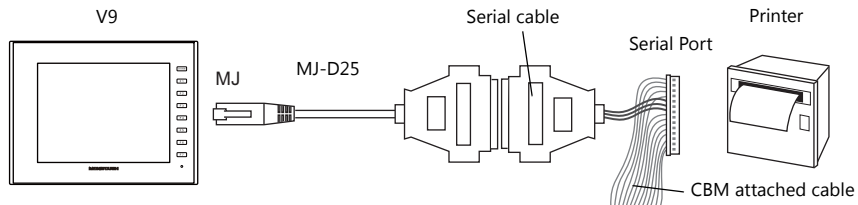

### Hardware Settings

Configure the [System Setting] → [Hardware Setting] → [Printer] settings.

#### Printer model

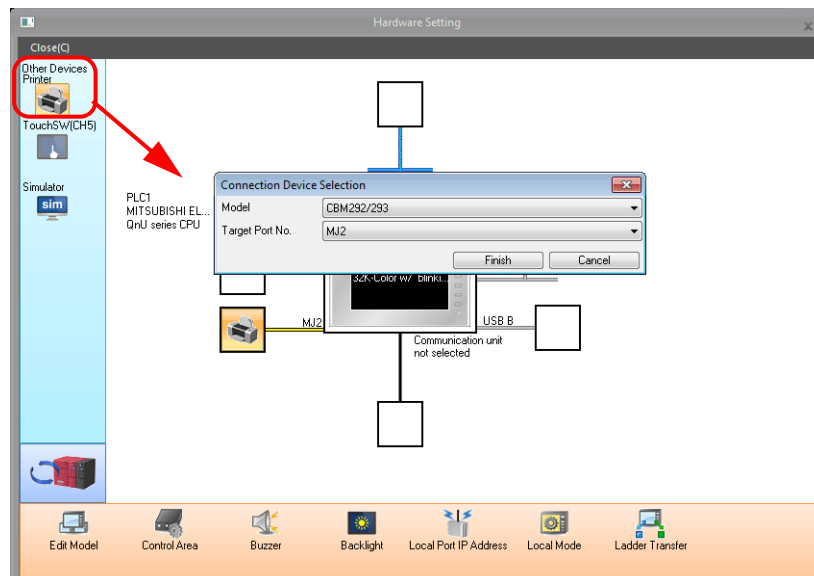

Item	Description
Model	Select CBM292/293.
Target Port No.	Select the port where the printer cable is connected. USB-A: Select this option when connecting to a parallel interface printer with a USB-parallel conversion cable (commercially available). MJ1/MJ2: Select this option when connecting to a printer equipped with a serial interface. Select either MJ1 or MJ2 on the V9 series unit.



## Printer properties

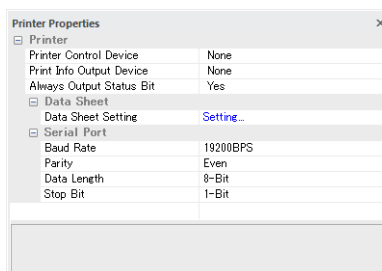

Item	Description																																
Printer Control Device (Yes/None)	<p>When this setting is enabled and the bit is set to ON (0 → 1), screen images and data sheets can be printed out.</p> <p>MSB <span style="float: right;">LSB</span></p> <table border="1" style="width: 100%; text-align: center;"> <tr> <td>15</td><td>14</td><td>13</td><td>12</td><td>11</td><td>10</td><td>09</td><td>08</td><td>07</td><td>06</td><td>05</td><td>04</td><td>03</td><td>02</td><td>01</td><td>00</td> </tr> <tr> <td>0</td><td>0</td><td>0</td><td>0</td><td>0</td><td>0</td><td>0</td><td>0</td><td>0</td><td>0</td><td>0</td><td>0</td><td>0</td><td>0</td><td>0</td><td>0</td> </tr> </table> <p style="text-align: right;">0 → 1: Screen image output 0 → 1: Data sheet output</p>	15	14	13	12	11	10	09	08	07	06	05	04	03	02	01	00	0	0	0	0	0	0	0	0	0	0	0	0	0	0	0	0
15	14	13	12	11	10	09	08	07	06	05	04	03	02	01	00																		
0	0	0	0	0	0	0	0	0	0	0	0	0	0	0	0																		
Printer Info Output Device (Yes/None)	<p>When using a device memory for outputting printer information, the printer state is output to the specified address.</p> <p>MSB <span style="float: right;">LSB</span></p> <table border="1" style="width: 100%; text-align: center;"> <tr> <td>15</td><td>14</td><td>13</td><td>12</td><td>11</td><td>10</td><td>09</td><td>08</td><td>07</td><td>06</td><td>05</td><td>04</td><td>03</td><td>02</td><td>01</td><td>00</td> </tr> <tr> <td>0</td><td>0</td><td>0</td><td>0</td><td>0</td><td>0</td><td>0</td><td>0</td><td>0</td><td>0</td><td>0</td><td>0</td><td>0</td><td>0</td><td>0</td><td>0</td> </tr> </table> <p style="text-align: right;">0: End (standby) 1: Transferring print data 0: Not busy 1: Busy</p>	15	14	13	12	11	10	09	08	07	06	05	04	03	02	01	00	0	0	0	0	0	0	0	0	0	0	0	0	0	0	0	0
15	14	13	12	11	10	09	08	07	06	05	04	03	02	01	00																		
0	0	0	0	0	0	0	0	0	0	0	0	0	0	0	0																		
Always Output Status Bit (Yes/None)	<p>The V9 series outputs [0 → 1] when starting to transfer data upon receiving a print command, and outputs [1 → 0] upon finishing transfer. However, these signals may not be output if the print data is small. Set to "Yes" when bit output is required regardless of the data size.</p> <p>The output area is shown below.</p> <ul style="list-style-type: none"> <li>• Bit 1 of the device memory for outputting printer information</li> <li>• Bit 0 of internal device memory \$s16</li> </ul> <p>\$s16</p> <p>MSB <span style="float: right;">LSB</span></p> <table border="1" style="width: 100%; text-align: center;"> <tr> <td>15</td><td>14</td><td>13</td><td>12</td><td>11</td><td>10</td><td>09</td><td>08</td><td>07</td><td>06</td><td>05</td><td>04</td><td>03</td><td>02</td><td>01</td><td>00</td> </tr> <tr> <td>0</td><td>0</td><td>0</td><td>0</td><td>0</td><td>0</td><td>0</td><td>0</td><td>0</td><td>0</td><td>0</td><td>0</td><td>0</td><td>0</td><td>0</td><td>0</td> </tr> </table> <p style="text-align: right;">0: End (standby) 1: Transferring print data</p>	15	14	13	12	11	10	09	08	07	06	05	04	03	02	01	00	0	0	0	0	0	0	0	0	0	0	0	0	0	0	0	0
15	14	13	12	11	10	09	08	07	06	05	04	03	02	01	00																		
0	0	0	0	0	0	0	0	0	0	0	0	0	0	0	0																		
Data Sheet	<p>Data Sheet Setting</p> <p>Configure settings for data sheet printing. For details, refer to <a href="#">page 16-17</a>.</p>																																
Serial Port *	Baud Rate	Specify the baud rate. 4800 / 9600 / 19200 / 38400 / 57600 / 76800 / 115K BPS																															
	Parity	Set the parity. None, Odd, Even																															
	Data Length	Set the number of bits for data. 7-Bit, 8-Bit																															
	Stop Bit	Set the number of stop bits. 1-Bit, 2-Bit																															

\* This setting is only available when MJ1 or MJ2 is selected for [Target Port No.].

## 16.1.6 Sato's MR-400 Barcode Printer

---

The V9 series can connect to Sato's barcode printer for printing barcodes.

---



Read the instruction manual and command reference book for Sato's MR-400 series barcode printer before using this function.

---



- For details on configuration and printing, refer to "[16.4 Connecting to a Sato MR-400 Barcode Printer](#)" page 16-26.
- For information on connectable models, visit our website at <http://www.monitouch.com>.

## 16.2 Hard copy

### 16.2.1 Overview

The displayed screen can be printed using the switch function or a command from the PLC.

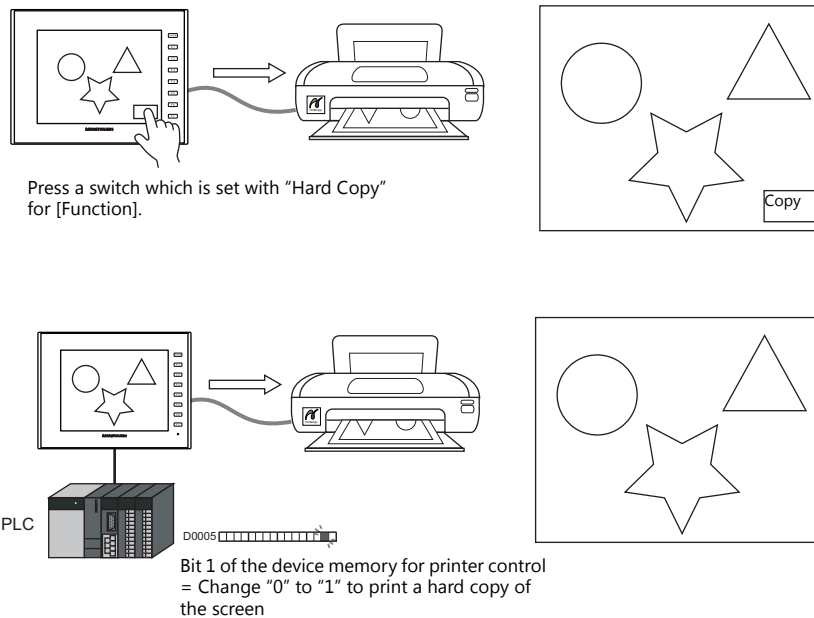

### 16.2.2 Printing

Two methods are available for printing the currently displayed screen.

#### Command from a Switch

A hard copy is produced by pressing the switch. The switch placed on the screen is also printed out.

#### Screen program setting

- 1) Place a switch set with "Hard Copy" for [Function] on the screen targeted for printing.
- 2) Transfer the screen data to the V9 series unit.

#### Printing procedure

- 1) Display the screen to be printed.
- 2) Press the hard copy switch.
- 3) Printing starts.

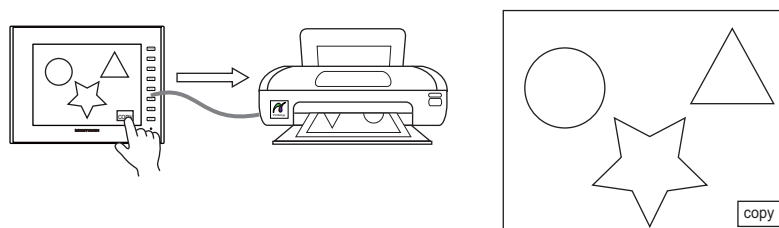

## Command from a Device Memory for Printer Control

---

Bit 1 of the device memory for printer control is the screen hard copy bit.  
When this bit changes from "0" to "1", a hard copy is printed.

### Printing procedure

- 1) Display the screen to be printed.
- 2) Change bit 1 of the device memory for printer control from "0" to "1".
- 3) Printing starts.

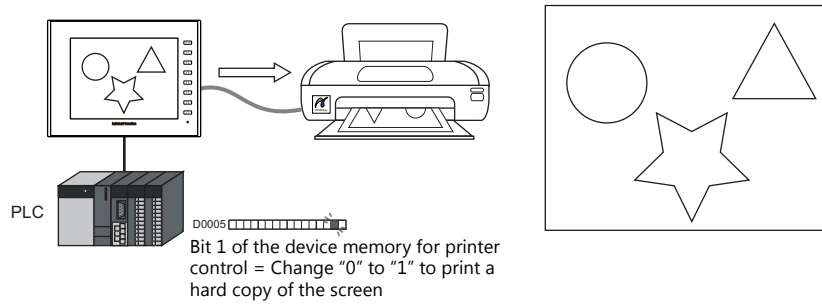

## 16.3 Printing Data Sheets

### 16.3.1 Overview

This section explains printing the data currently displayed on numerical data displays or character displays that are registered on a data sheet.

This print function also enables real-time printing of device memory data that is not shown on the V9 series.

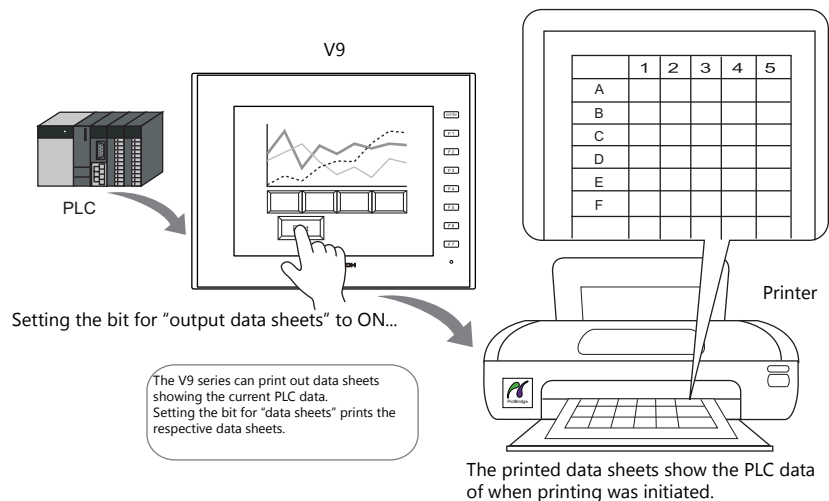

Data can also be output in PDF file format to a storage device.

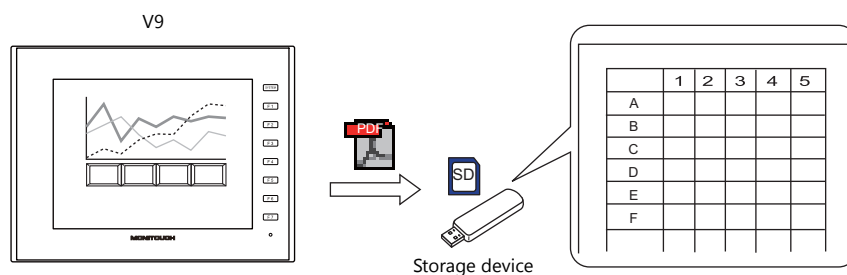

### Expanded functions

The data sheet expanded functions are available with the PictBridge printer or EPSON printer that supports "ESC/P-R" codes. The expanded functions allow additional parts, such as lamps and graphs, to be used and changing of the sizes of those parts. Moreover, the expanded functions allow for part placement regardless of the grid, thereby diversifying layouts on data sheet screens. These data sheets can be printed in color.

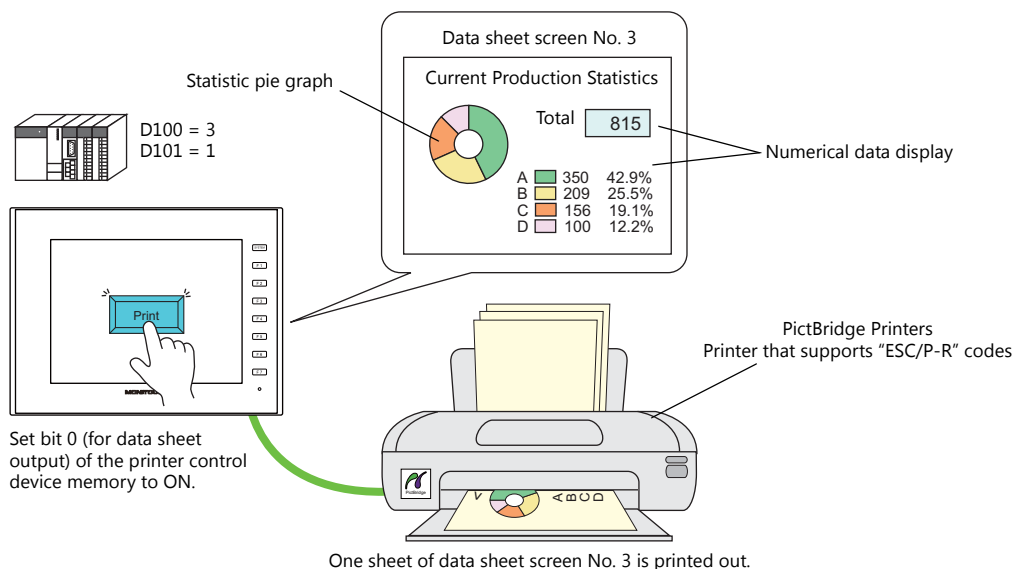

## Data sheet screen

The print screen is formatted in "Data Sheet" in the V9 series screen program file.

Items usable on data sheets vary depending on whether the expanded functions are used.

- Without the expanded functions

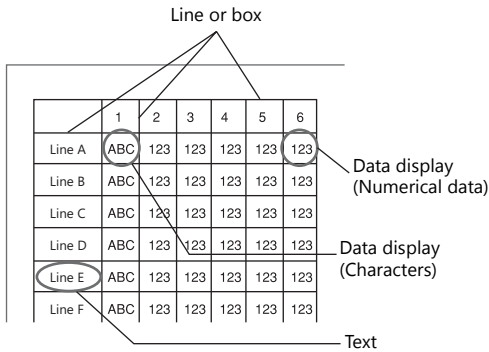

- With the expanded functions

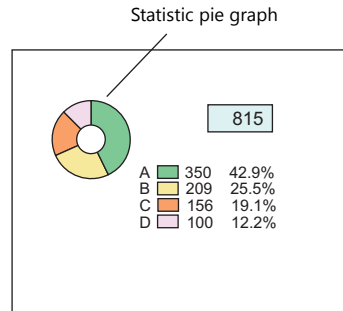

Item	Without Expanded Functions	With Expanded Functions (With PictBridge only)
Graphics	Straight line Rectangle Text	Line/continuous line Box/circle Text/multi text Pixel Paint Scaling Pattern
Parts	Numerical data display Character display	Lamp Numerical data display Character display Message display Bar graph Pie graph Panel meter Statistic bar graph Statistic pie graph Time display/calendar

For details on the data sheet editing procedure, refer to the V9 Series Operation Manual.

## 16.3.2 Detailed Settings

### Data Sheet Setting

#### Use extension data sheet: unselected

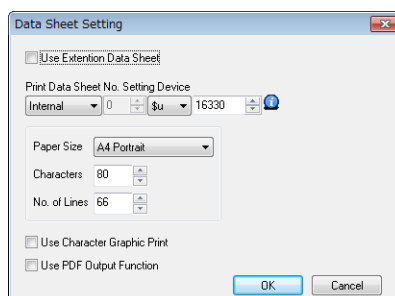

Item	Description																		
Print Data Sheet No. Setting Device	<p>Use this device memory when printing data sheets using a device memory for printer control (refer to <a href="#">page 16-23</a>). Two words are used.</p> <table border="1"> <tr> <td>n</td> <td>Print start data sheet number (→ V)</td> </tr> <tr> <td>n+1</td> <td>Number of pages to be printed (→ V)</td> </tr> </table>	n	Print start data sheet number (→ V)	n+1	Number of pages to be printed (→ V)														
n	Print start data sheet number (→ V)																		
n+1	Number of pages to be printed (→ V)																		
Paper Size (A4 Portrait, A4 Landscape, 15-Inch Landscape, User Designation)	<p>Select a paper size. According to the size selected, the numbers of characters and lines are set. Printed images are always in portrait orientation.</p> <p>* Only A4 portrait and A4 landscape are supported when outputting a PDF to a storage device.</p>																		
Characters (16 to 152)	Specify the number of characters per line on a data sheet page.																		
No. of Lines (2 to 152)	Specify the number of lines per data sheet page.																		
Use Character Graphic Print	<p>Select this checkbox to change the set number of lines. The numbers of characters and lines are automatically set as shown below.</p> <table border="1"> <thead> <tr> <th rowspan="2">Paper Size</th> <th rowspan="2">No. of Characters</th> <th colspan="2">No. of Lines</th> </tr> <tr> <th>Character Graphics Not used</th> <th>Character Graphics Used</th> </tr> </thead> <tbody> <tr> <td>A4 Portrait</td> <td>80</td> <td>66</td> <td>108</td> </tr> <tr> <td>A4 Landscape</td> <td>114</td> <td>40</td> <td>64</td> </tr> <tr> <td>15-Inch Landscape</td> <td>136</td> <td>64</td> <td>64</td> </tr> </tbody> </table> <p>* This setting is valid only for Japanese printers. (ESC/P-R and PictBridge are not supported)</p> <p>* All characters and lines on the data sheet screen are handled as text. Consequently, the printed data sheet looks slightly different from the one on the editor screen.</p>	Paper Size	No. of Characters	No. of Lines		Character Graphics Not used	Character Graphics Used	A4 Portrait	80	66	108	A4 Landscape	114	40	64	15-Inch Landscape	136	64	64
Paper Size	No. of Characters			No. of Lines															
		Character Graphics Not used	Character Graphics Used																
A4 Portrait	80	66	108																
A4 Landscape	114	40	64																
15-Inch Landscape	136	64	64																

Item	Description																																
<p>Use PDF Output Function</p>	<p>Select this checkbox to output data sheets to a storage device in PDF format. Storage target: \access folder\LIST\year month folder\year month day folder</p> <ul style="list-style-type: none"> <li>• With time stamp             <ul style="list-style-type: none"> <li>- (filename) abcd0000_20140420203000.pdf ← with filename specification</li> <li>- LIST0000_20140420203000.pdf ← without filename specification</li> </ul> </li> <li>• Without time stamp             <ul style="list-style-type: none"> <li>- (filename) abcd0000.pdf ← with filename specification</li> <li>- LIST0000.pdf ← without filename specification</li> </ul> </li> </ul>																																
<p>Command Device</p>	<p>Select this checkbox to select the bit status for the data sheet output destination and whether a time stamp is added to filenames.</p> <p>* When using the "STA_LIST" macro, set the output destination and whether to add a time stamp using "\$s1656". The device memory information is the same as the device memory selected as the output destination.</p> <table border="1" data-bbox="630 779 1241 835"> <tr> <td>15</td><td>14</td><td>13</td><td>12</td><td>11</td><td>10</td><td>09</td><td>08</td><td>07</td><td>06</td><td>05</td><td>04</td><td>03</td><td>02</td><td>01</td><td>00</td> </tr> <tr> <td>0</td><td>0</td><td>0</td><td>0</td><td>0</td><td>0</td><td>0</td><td>0</td><td>0</td><td>0</td><td>0</td><td>0</td><td>0</td><td>0</td><td></td><td></td> </tr> </table> <p style="margin-left: 400px;">0: With time stamp 1: Without time stamp</p> <p style="margin-left: 400px;">0: Printer 1: Storage device (PDF output)</p>	15	14	13	12	11	10	09	08	07	06	05	04	03	02	01	00	0	0	0	0	0	0	0	0	0	0	0	0	0	0		
15	14	13	12	11	10	09	08	07	06	05	04	03	02	01	00																		
0	0	0	0	0	0	0	0	0	0	0	0	0	0																				
<p>File Designation (Maximum of 64 one-byte alphanumeric characters)</p>	<p>Specify a filename. Selecting a device memory address allows the output filename to be changed when the unit is in RUN mode. 32 consecutive words are used from the specified address.</p> <p>* This is only available for the internal device memory of the V9 series.</p> <p>Example: With time stamp</p> <ul style="list-style-type: none"> <li>- When specifying a filename Filename: (filename)XXXX_YYYYMMDDHHMMSS</li> </ul> <ul style="list-style-type: none"> <li>- When not specifying a filename or when the device memory contains "null" Filename: LISTXXXX_YYYYMMDDHHMMSS</li> </ul> <p>* If space on the storage device is insufficient, the file is saved after automatically deleting the oldest folder.</p>																																
<p>PDF Output Drive (None, SD, USB)</p>	<p>Select the output target drive for the PDF file.</p> <p>* If "None" is specified, the PDF file is output to [Storage Connection Target] in the [Storage Setting].</p>																																



### Use extension data sheet: selected

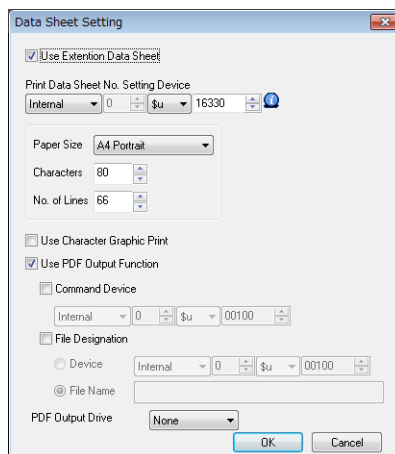

Item	Description						
Print Data Sheet No. Setting Device	<p>Use this device memory when printing data sheets using commands from a device memory for printer control (refer to <a href="#">page 16-23</a>). Two words are used.</p> <table border="1"> <tr> <td>n</td> <td>Print start data sheet number (→ V)</td> </tr> <tr> <td>n+1</td> <td>Number of pages to be printed (→ V)</td> </tr> </table>	n	Print start data sheet number (→ V)	n+1	Number of pages to be printed (→ V)		
n	Print start data sheet number (→ V)						
n+1	Number of pages to be printed (→ V)						
Paper Size (A4 Portrait, A4 Landscape)	<p>Select the orientation of the data sheet screen. (Paper size: A4 fixed)</p> <table border="1"> <thead> <tr> <th>Paper Size (Graphic area: height × width)</th> <th>Orientation</th> </tr> </thead> <tbody> <tr> <td>A4 Portrait (912 × 640 pixels)</td> <td>Vertical</td> </tr> <tr> <td>A4 Landscape (640 × 912 pixels)</td> <td>Horizontal</td> </tr> </tbody> </table> <p>Example: Print on A4 paper fed in portrait orientation</p>	Paper Size (Graphic area: height × width)	Orientation	A4 Portrait (912 × 640 pixels)	Vertical	A4 Landscape (640 × 912 pixels)	Horizontal
Paper Size (Graphic area: height × width)	Orientation						
A4 Portrait (912 × 640 pixels)	Vertical						
A4 Landscape (640 × 912 pixels)	Horizontal						
Use PDF Output Function	<p>Select this checkbox to output data sheets to a storage device in PDF format. Storage target: \access folder\LIST\year month folder\year month day folder</p> <ul style="list-style-type: none"> <li>• With time stamp             <ul style="list-style-type: none"> <li>- (filename) abcd0000_20140420203000.pdf ← with filename specification</li> <li>- LIST0000_20140420203000.pdf ← without filename specification</li> </ul> </li> <li>• Without time stamp             <ul style="list-style-type: none"> <li>- (filename) abcd0000.pdf ← with filename specification</li> <li>- LIST0000.pdf ← without filename specification</li> </ul> </li> </ul>						

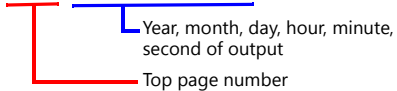
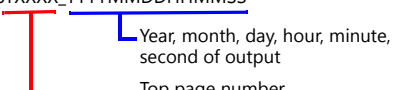
Item	Description																																
Command Device	<p>Select this checkbox to select the bit status for the data sheet output destination and whether a time stamp is added to filenames.</p> <p>* When using the "STA_LIST" macro, set the output destination and whether to add a time stamp using "\$s1656". The device memory information is the same as the device memory selected as the output destination.</p> <table border="1" data-bbox="630 342 1241 398"> <tr> <td>15</td><td>14</td><td>13</td><td>12</td><td>11</td><td>10</td><td>09</td><td>08</td><td>07</td><td>06</td><td>05</td><td>04</td><td>03</td><td>02</td><td>01</td><td>00</td> </tr> <tr> <td>0</td><td>0</td><td>0</td><td>0</td><td>0</td><td>0</td><td>0</td><td>0</td><td>0</td><td>0</td><td>0</td><td>0</td><td>0</td><td>0</td><td></td><td></td> </tr> </table> <p>0: With time stamp 1: Without time stamp</p> <p>0: Printer 1: Storage device (PDF output)</p>	15	14	13	12	11	10	09	08	07	06	05	04	03	02	01	00	0	0	0	0	0	0	0	0	0	0	0	0	0	0		
15	14	13	12	11	10	09	08	07	06	05	04	03	02	01	00																		
0	0	0	0	0	0	0	0	0	0	0	0	0	0																				
Use PDF Output Function	<p>File Designation (Maximum of 64 one-byte alphanumeric characters)</p> <p>Specify a filename. Selecting a device memory address allows the output filename to be changed when the unit is in RUN mode. 32 consecutive words are used from the specified address.</p> <p>* This is only available for the internal device memory of the V9 series.</p> <p>Example: With time stamp</p> <ul style="list-style-type: none"> <li>- When specifying a filename Filename: (filename)XXXX_YYYYMMDDHHMMSS</li> </ul>  <ul style="list-style-type: none"> <li>- When not specifying a filename or when the device memory contains "null" Filename: LISTXXX_YYYYMMDDHHMMSS</li> </ul>  <p>* If space on the storage device is insufficient, the file is saved after automatically deleting the oldest folder.</p>																																
PDF Output Drive (None, SD, USB)	<p>Select the output target drive for the PDF file.</p> <p>* If "None" is specified, the PDF file is output to [Storage Connection Target] in the [Storage Setting].</p>																																

## 16.3.3 Printing

There are two methods for printing configured data sheets from the V9 series unit.

### Command from a Device Memory for Printer Control

Bit 0 of the device memory for printer control is the data sheet output bit.  
When this bit changes from "0" to "1", a data sheet is printed.

### Printing/PDF output procedure

- 1) Set the data sheet number that is the top page to [Print Data Sheet No. Setting Device] "n".
- 2) Specify the number of output pages for [Print Data Sheet No. Setting Device] "n + 1".  
\* **When [Print Data Sheet No. Setting Device] "n + 1" is "0", the printer will not print any data sheets.**
- 3) Change bit 0 of the device memory for printer control from "0" to "1".
- 4) Data sheet printing starts.

Usage Example  
[Printer Control Device] = D0005  
[Designation Device for Print Data Sheet No.] = D0010

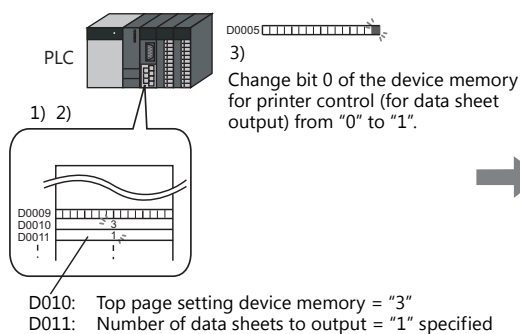
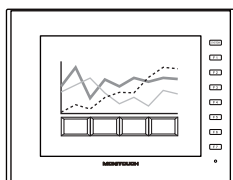

- 4)  
One page of data sheet No. 3 is printed.

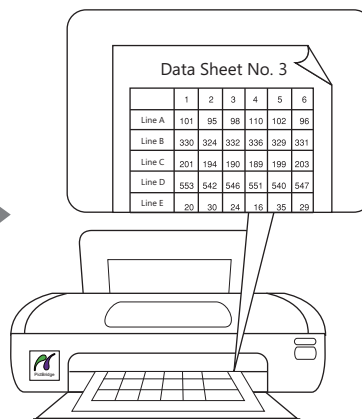

## Command with Macro

Use the "STA\_LIST" macro command to print data sheets.

### Device memory used

	Internal Device Memory	PLC1 to PLC8 Device Memory	Memory Card	Constant
F1	◎			

○: Setting enabled (indirect designation disabled) ◎: Setting enabled (indirect designation enabled)

### Range

	Value	Remarks
F0	STA_LIST	
F1	Print start data sheet number	
F1 + 1	Number of pages to be printed: 1 to 1,024 *	
F1 + 2	ASCII code: Output filename (maximum of 64 one-byte alphanumeric characters)	Only available when \$s1656 = 1 (PDF output)
:		
F1 + 33		

\* No printing is executed when "0" is set as the number of pages to be printed. When the range specified for printing includes an unregistered number, the page corresponding to the number will not be printed.

### Printing procedure

- 1) Set the data sheet number which is to be the top page to the device memory "F1 + 0".
- 2) Set the number of output pages to the device memory "F1+1".
- 3) Execute the "STA\_LIST" macro command.
- 4) Data sheet printing starts.

Print example:

To print data sheet No. 3 with F1 = \$u100:

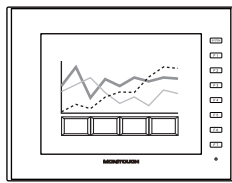

- 1) \$u100 = 3 (W) Print start data sheet number
- 2) \$u101 = 1 (W) Number of pages to be printed
- 3) SYS (STA\_LIST) \$u100 Macro execution

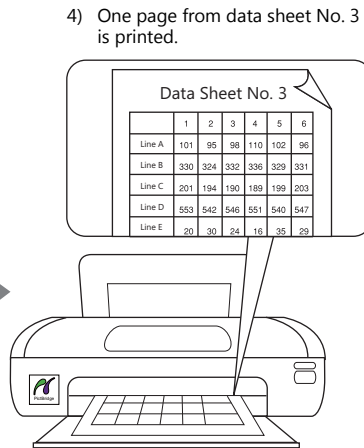

- 4) One page from data sheet No. 3 is printed.

### PDF output procedure

- 1) Set \$s1656 = 1.
- 2) Set the data sheet number which is to be the top page to the device memory "F1 + 0".
- 3) Set the number of output pages to the device memory "F1+1".
- 4) To add a filename to the PDF file, set the filename to "F1 + 2" onwards.
- 5) Execute the "STA\_LIST" macro command.
- 6) The data sheet is output to a PDF file on the storage device.

Operation Example

To output data sheet No. 3 to a PDF with F1 = \$u100:

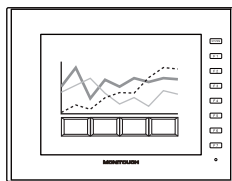

- 1) \$s1656 = 1 (W)
- 2) \$u100 = 3 (W)
- 3) \$u101 = 1 (W)
- 4) \$u102 = TEST (STRING)
- 5) SYS (STA\_LIST) \$u100

Selected output target: PDF  
 Print start data sheet number  
 Number of pages to be printed  
 Filename  
 Macro execution



- 6) One page of data sheet No. 3 is output as a PDF file.

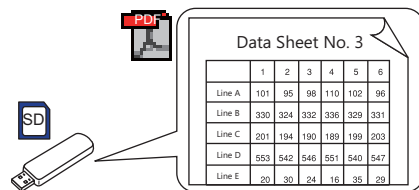

## Notes

When no data sheet screen has been registered, data sheets cannot be printed even if they are specified by number.

Print example:

[Printer Control Device] = D0005

[Print Data Sheet No. Setting Device] = D0010

Diagram showing four data sheet pages: No. 10, No. 11, No. 12, and No. 14. No. 13 is missing. Each page contains a table with columns for 'Printer Control Device' and 'Print Data Sheet No. Setting Device'.

If data sheet pages are registered as shown on the left

D0010 (top page number of data sheet for printing) = 10  
D0011 (number of pages of data sheet to output) = 5

Change bit 0 (data sheet output) of D0005 from "0" to "1".

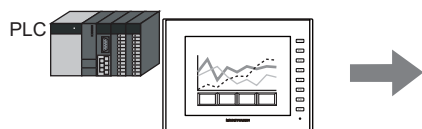

Data sheet No. 10 to 12 and 14 are printed.  
The page that is not stored, No. 13, is ignored, and four pages are output.

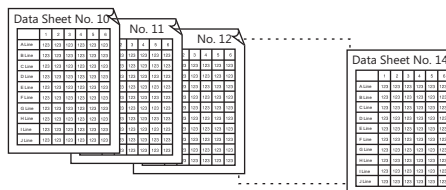

## 16.4 Connecting to a Sato MR-400 Barcode Printer

The V9 series can connect to Sato's barcode printer for printing barcodes.



Read the instruction manual and command reference book for Sato's MR-400 series barcode printer before using this function.



For information on connectable models, visit our website at <http://www.monitouch.com>.

### 16.4.1 Connection Method

#### Serial connection (MJ1 or MJ2)

- Connect the MJ port of the V9 series unit with the serial port of the printer.

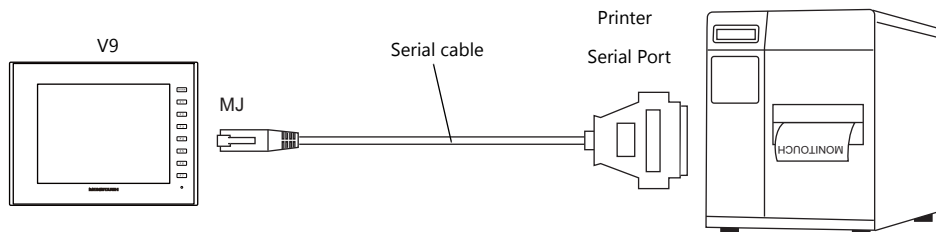

#### Hardware Settings

Configure the [System Setting] → [Hardware Setting] → [Printer] settings.

#### Printer model

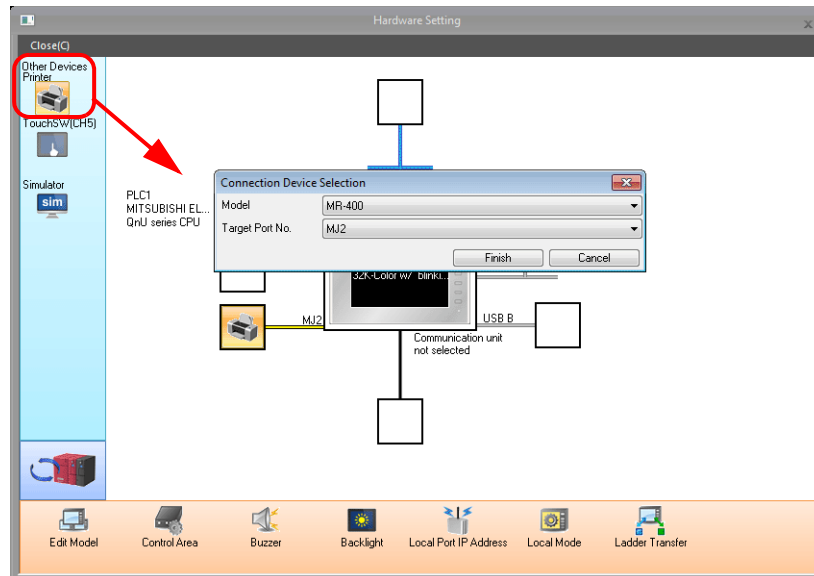

Item	Description
Model	Select MR400.
Target Port No.	MJ1/MJ2 Select either MJ1 or MJ2 on the V9 series unit.

## Printer properties

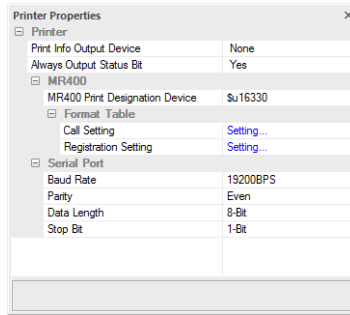

Item	Description																																
Print Info Output Device (Yes/None)	<p>When using a device memory for outputting printer information, the printer state is output to the specified address.</p> <p>MSB <span style="float: right;">LSB</span></p> <table border="1" style="margin-left: auto; margin-right: auto;"> <tr> <td>15</td><td>14</td><td>13</td><td>12</td><td>11</td><td>10</td><td>09</td><td>08</td><td>07</td><td>06</td><td>05</td><td>04</td><td>03</td><td>02</td><td>01</td><td>00</td> </tr> <tr> <td>0</td><td>0</td><td>0</td><td>0</td><td>0</td><td>0</td><td>0</td><td>0</td><td>0</td><td>0</td><td>0</td><td>0</td><td>0</td><td>0</td><td>0</td><td>0</td> </tr> </table> <p style="text-align: center;">0: End (standby) <span style="margin-left: 100px;">0: Not busy</span></p> <p style="text-align: center;">1: Transferring print data <span style="margin-left: 100px;">1: Busy</span></p>	15	14	13	12	11	10	09	08	07	06	05	04	03	02	01	00	0	0	0	0	0	0	0	0	0	0	0	0	0	0	0	0
15	14	13	12	11	10	09	08	07	06	05	04	03	02	01	00																		
0	0	0	0	0	0	0	0	0	0	0	0	0	0	0	0																		
Always Output Status Bit (Yes/None)	<p>The V9 series outputs [0 → 1] when starting to transfer data upon receiving a print command, and outputs [1 → 0] upon finishing transfer. However, these signals may not be output if the print data is small.</p> <p>Set to "Yes" when bit output is required regardless of the data size.</p> <p>The output area is shown below.</p> <ul style="list-style-type: none"> <li>• Bit 1 of the device memory for outputting printer information</li> <li>• Bit 0 of internal device memory \$s16</li> </ul> <p>\$s16 <span style="float: right;">LSB</span></p> <table border="1" style="margin-left: auto; margin-right: auto;"> <tr> <td>15</td><td>14</td><td>13</td><td>12</td><td>11</td><td>10</td><td>09</td><td>08</td><td>07</td><td>06</td><td>05</td><td>04</td><td>03</td><td>02</td><td>01</td><td>00</td> </tr> <tr> <td>0</td><td>0</td><td>0</td><td>0</td><td>0</td><td>0</td><td>0</td><td>0</td><td>0</td><td>0</td><td>0</td><td>0</td><td>0</td><td>0</td><td>0</td><td>0</td> </tr> </table> <p style="text-align: center;">0: End (standby) <span style="margin-left: 100px;">1: Transferring print data</span></p>	15	14	13	12	11	10	09	08	07	06	05	04	03	02	01	00	0	0	0	0	0	0	0	0	0	0	0	0	0	0	0	0
15	14	13	12	11	10	09	08	07	06	05	04	03	02	01	00																		
0	0	0	0	0	0	0	0	0	0	0	0	0	0	0	0																		
MR400	MR400 Print Designation Device	This setting can be configured when MR400 is selected for the printer model. Set the device memory used to issue printing commands to the MR400. For details, refer to "Print Command Device" page 16-37.																															
	Format Table	Register the printing format. For details, refer to "16.4.3 Format Tables" page 16-28.																															
Serial Port	Baud Rate	Specify the baud rate. 4800 / 9600 / 19200 / 38400 / 57600 / 76800 / 115K BPS																															
	Parity	Set the parity. None, Odd, Even																															
	Data Length	Set the number of bits for data. 7-Bit, 8-Bit																															
	Stop Bit	Set the number of stop bits. 1-Bit, 2-Bit																															

### 16.4.2 Notes on Memory Cards

#### Memory Cards

To use this function, a memory card is required for the MR400.  
For the memory card type and mounting procedure, refer to the instruction manual for the MR-400 series.

## Card Slot Number Setting and Memory Card Formatting

To enable the use of memory cards, set the memory card slot number and format the memory card on the MR-400.

\* **“Memory card formatting” means the same as media initialization for USB flash drives etc.**

- 1) Turn off the power to the MR-400 and insert a memory card into the card slot on the rear of the MR-400.
- 2) Hold down the LINE key on the front of MR-400, and turn the power ON.  
“USER MODE” is displayed on the front panel.
- 3) Press the LINE key and FEED key at the same time.  
“ADVANCED MODE” is displayed.
- 4) Press the LINE key and FEED key at the same time again.  
“CARD MODE” is displayed.
- 5) Press the FEED key until “CARD DRIVE NO / 1 2” is displayed.  
Set the memory card slot number.  
(Press the LINE key to select, and press the FEED key to accept.)  
This drive number is the memory card slot number.
- 6) Press the FEED key to accept the options. Select “YES” for “CARD FORMAT / YES NO” and format the memory card.  
If no error is given, formatting has completed successfully.
- 7) To quit “CARD MODE,” turn the printer off.

- Formatting is required if the screen program is transferred after editing the MR-400 format table (registration setting) described in the following section.

In addition to the above formatting procedure, it is possible to format the memory card by outputting the control command of MR-400 from the V9 series. For details, refer to [Example 1: When the following commands are set in No. 22: \(page 16-36\)](#).

- When printing two-byte characters, select “JIS” for “Kanji Code” on MR-400.

### 16.4.3 Format Tables

#### Format Table Types

There are two types of format tables.

When the MR-400 commands are registered in this table, desired formats or data can be printed.

#### MR-400 format table (registration setting)

Set the print format.

\* **The “format” used in the format table includes settings for digits, position, typeface, barcode, etc. for the MR-400.**

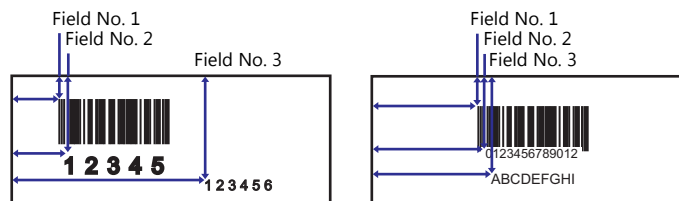

Write these settings on the memory card using the MR\_REG macro command.

Once they are written on the memory card, it is not necessary to repeat this step until the registration setting is changed.

#### MR-400 format table (call setting)

Use the format (registration setting), and change the print data. Set the storage target, type, etc. of the changed data.

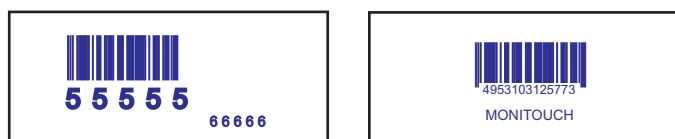

Print the data using the MR\_OUT macro command.



## Format Table (Registration Setting)

Configure the [System Setting] → [Communication Setting] group → [Hardware Setting] → [Printer] → [Format Table (Registration Setting)] settings.

Format table settings (registration settings) range from No. 1 to No. 128.

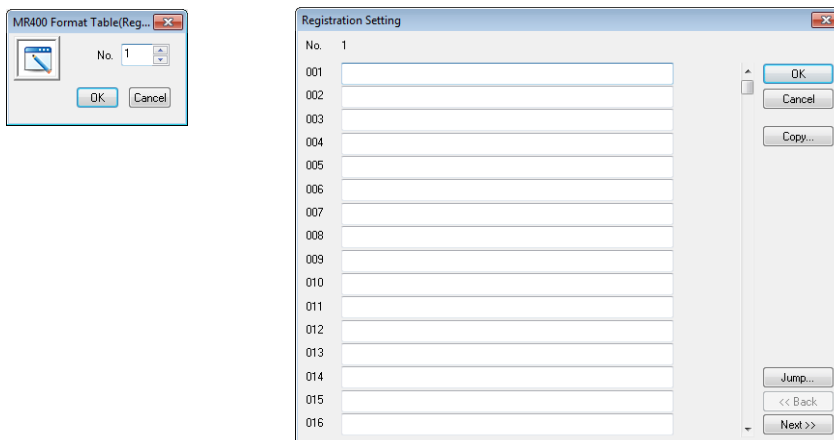

Item	Description
OK	The format table setting is ended.
Cancel	Format table editing is canceled.
Copy	The currently open format table is copied into the specified table.
Jump	The specified format table is opened.
Back	The previous format table number is opened.
Next	The following format table is opened.

### Setting example

To print in the following format:

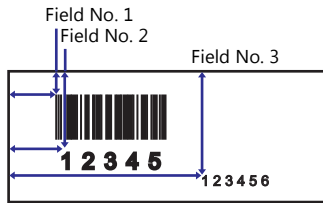

- Description of escape sequence

<A>  
 <Data send start>  
 <CC> 2  
 <Card slot> Slot number  
 <YS>, 1 0  
 <Format register>, Format register number \_\_\_\_\_ Match this number to the registration setting number.

</N>, 1, 1 0  
 <Field register>, field number, print digits  
 <V> 1 0 <H> 5 0  
 <Vertical print position> dots <Horizontal print position> dots  
 <B> 2020801234567890  
 <Barcode> Bar code type, bar width enlargement, bar top/bottom size (dots), data

Data registered for field No. 1

</N>, 2, 5  
 <V>1 0 0 <H> 5 0 <L> 0 2 0 2 <P> 2  
 <X22>, 1 2 3 4 5  
 <X22 characters>, data

Data registered for field No. 2

</N>, 3, 6  
 <V> 1 5 0 <H> 3 0 0 <L> 0 1 0 1 <P> 2  
 <X2 2>, 1 2 3 4 5 6

Data registered for field No. 3

<Z>  
 <Data send end>

- Description of the format table

Match these numbers.

No.	Setting
001	\1b\A\1bCC2
002	\1b\Y,10
003	\1b\N,1,10
004	\1b\10\1bH50
005	\1bB2020801234567890
006	\1b\N,2,5
007	\1b\100\1bH50\1bL0202\1bP2
008	\1b\X22,1,123456
009	\1b\N,3,6
010	\1b\150\1bH300\1bL0101\1bP2
011	\1b\X22,1,123456
012	\1bZ

### Notes on inputting

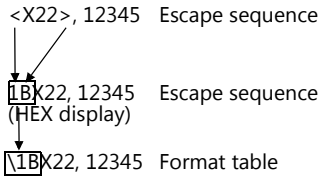

The escape character (ESC) at the top of the escape sequence is expressed as "<>" on MR-400 and as "1B(H)" in hexadecimal notation.

In the format table, "\" denotes hexadecimal data. Consequently, "1B(H)" is shown as "\1B".

To use "\" as a character, enter "\\\".

### MR400 Format Table (Call Setting)

Configure format table settings (call setting) at [System Setting] → [Unit Setting] → [MR400 Format Table] → [Call Setting]. Numbers 1 to 128 can be set in the format table.

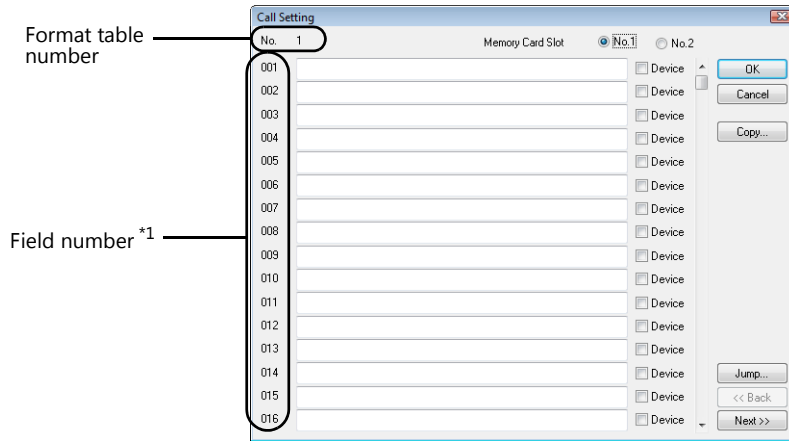

Item	Description
Memory Card Slot (No. 1 / No. 2)	Select the card slot drive number set on the MR-400.
Device	Select the checkbox when field data is stored in device memory.
OK	The format table setting is ended.
Cancel	Format table editing is canceled.
Copy	The currently open format table is copied into the specified table.
Jump	The specified format table is opened.
Back	The previous format table number is opened.
Next	The following format table is opened.

\*1 Field numbers 1 to 99 are used.  
Settings for numbers 100 to 512 are invalid.

### Setting example (1)

Printing "ABCDE" as a fixed string in field No. 1

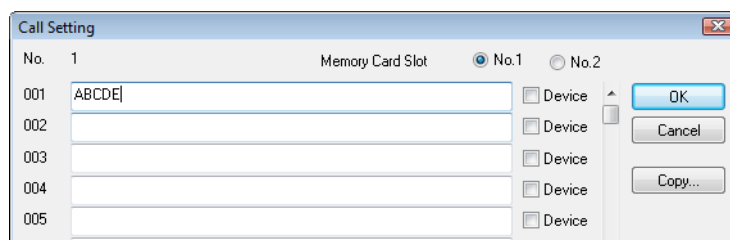

## Setting example (2)

Printing data stored in a device memory in field No. 2

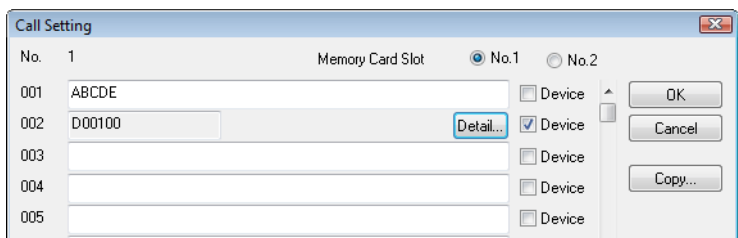

Select the [Device] checkbox of field No. 2.  
Press the [Detail] button to display the [Detail] window.

- Select [Text] for [Type].

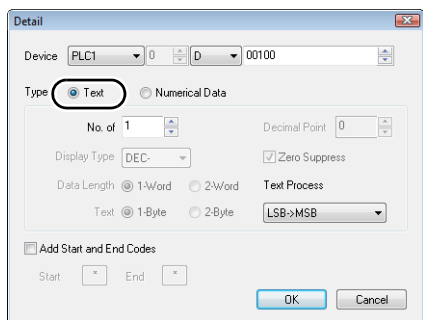

Item	Description						
Device	Specify the top device memory address where data for printing is stored.						
No. of Bytes	The specified number of bytes is output in order from the device memory address specified for [Device]. * To print "ABCDEF" in one-byte characters, specify as shown below in the Shift JIS code. <table border="1" style="margin-left: auto; margin-right: auto;"> <tr> <td>D100</td> <td>4241 [H]</td> </tr> <tr> <td>D101</td> <td>4443 [H]</td> </tr> <tr> <td>D102</td> <td>4645 [H]</td> </tr> </table>	D100	4241 [H]	D101	4443 [H]	D102	4645 [H]
D100	4241 [H]						
D101	4443 [H]						
D102	4645 [H]						
Text Process	LSB → MSB/MSB → LSB Set the order of the first and second bytes within one word.						
Add Start and End Codes	Configure this setting when using "CODE 39" type barcodes. (Refer to <a href="#">page 16-34.</a> )						

- Select [Numerical Data] for [Type].

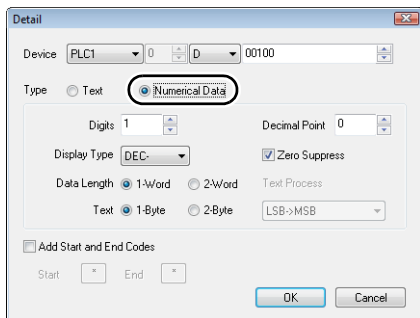

Item	Description
Device	Print data in the specified device memory address in numerical form. * When [Numerical Data] is selected, binary data is converted into characters (JIS code). Example: When "0100 (BIN)" is set for D100, the characters 0100 (= "100") are printed.
Digits	Specify the number of digits for the display type.
Decimal Point	Specify the number of decimal places.
Display Type	Select from DEC-, HEX, OCT, DEC or BIN. When [DEC-] is selected, data is shown in decimal notation with a ± sign.
Zero Suppress	Select whether or not to use the zero suppress function. When the [Zero Suppress] checkbox is selected, any suppressed zeros are filled with spaces.
Data Length	Set the data length for the device memory.
Text	Select one-byte or two-byte characters.
Add Start and End Codes	Configure this setting when using "CODE 39" type barcodes. (Refer to <a href="#">page 16-34.</a> )

## Barcode Type "CODE 39"

CODE 39 has "\*" at the beginning and the end of each barcode.  
 When the format table is created, set "\*" in the following two positions

- [MR-400 Format Table (Registration Setting)] settings
  - Set the number of digits including "\*" for format registration.
  - For the following case for example, set "12" (10 characters + 2).

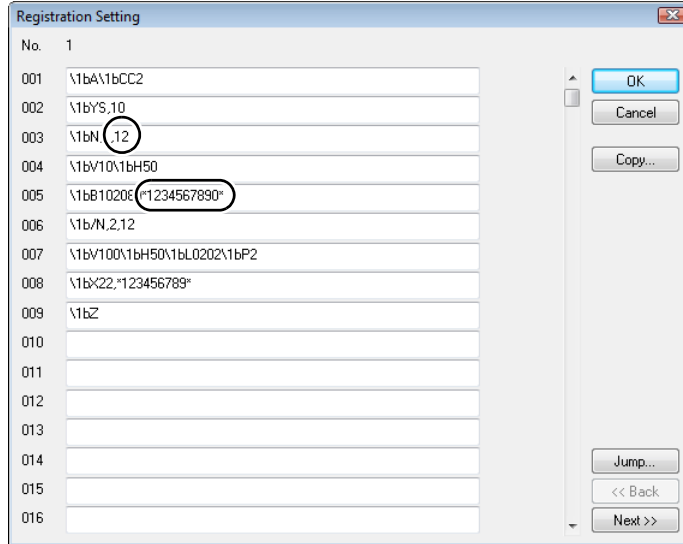

- [MR-400 Format Table (Call Setting)] settings
  - Select [Text] for [Type].

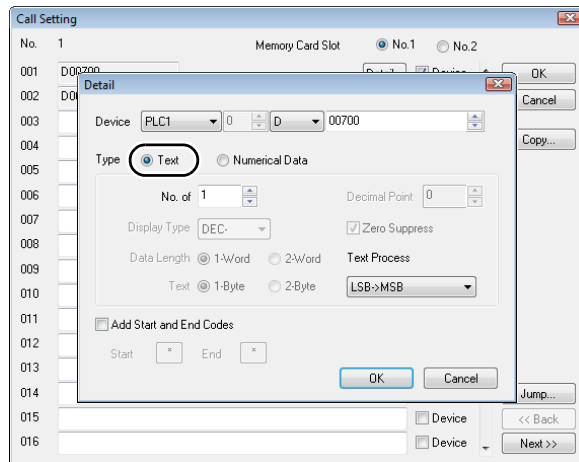

Item	Description
No. of Bytes	Specify the number of bytes including "*".
Add Start and End Codes	Selected: "*" is not included in the data of [Device]. Unselected: "*" is included in the data of [Device].

- Select [Numerical Data] for [Type].

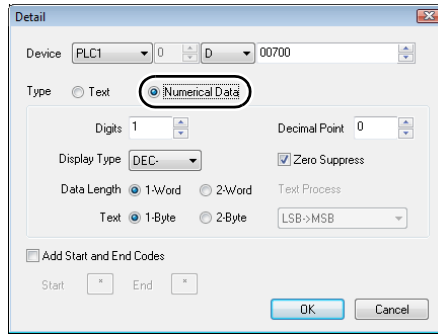

Item	Description
Add Start and End Codes	Selected: "*" is not included in the data of [Device]. Unselected: "*" is included in the data of [Device].

## 16.4.4 Printing

### Macros

The "MR\_REG" macro command is available to write the setting data from format tables (registration setting or call setting) to the MR-400. The "MR\_OUT" macro command is available to print out the data.

### MR\_REG

Device memory used

	Internal Device Memory	PLC1 to PLC8 Device Memory	Memory Card	Constant
F1	◎	◎	○	○

○: Setting enabled (indirect designation disabled) ◎: Setting enabled (indirect designation enabled)

Range

	Value
F0	Format table registration setting numbers 1 to 128

- Example 1: When the following commands are set in No. 22:

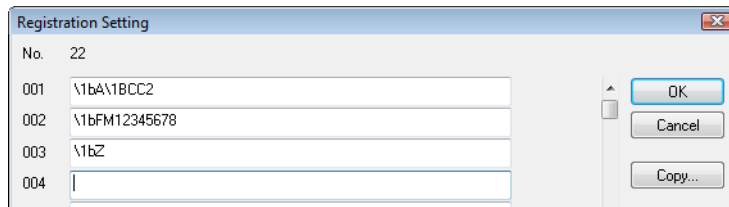

When the "MR\_REG 22" macro command is executed, the memory card is formatted.

- Example 2: When the following commands are set in No. 1:

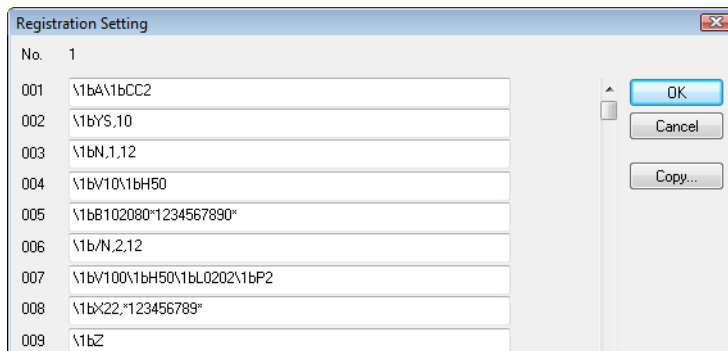

Execute the "MR\_REG 1" macro command as the ON macro of a switch.

First: The format is registered on the memory card of the MR-400.

Second: The registered data is printed and the format can be checked.

### MR\_OUT

Device memory used

	Internal Device Memory	PLC1 to PLC8 Device Memory	Memory Card	Constant
F1	◎	◎	○	○

○: Setting enabled (indirect designation disabled) ◎: Setting enabled (indirect designation enabled)

Range

	Value
F0	Format table call setting numbers 1 to 128

- Example 1: When the "MR\_OUT 50" macro command is executed:  
Data of the MR-400 format table (call setting No. 50) is printed.



## Print Command Device

Printing can be executed using an external command.

Item	Description																																
n	Control device memory MSB <span style="float: right;">LSB</span> <table border="1" style="margin-left: auto; margin-right: auto;"> <tr> <td>15</td><td>14</td><td>13</td><td>12</td><td>11</td><td>10</td><td>09</td><td>08</td><td>07</td><td>06</td><td>05</td><td>04</td><td>03</td><td>02</td><td>01</td><td>00</td> </tr> <tr> <td>0</td><td>0</td><td>0</td><td>0</td><td>0</td><td>0</td><td>0</td><td>0</td><td>0</td><td>0</td><td>0</td><td>0</td><td>0</td><td>0</td><td>0</td><td>0</td> </tr> </table> <p style="text-align: right; margin-right: 100px;">0: Standby 1: Printing</p> <p style="text-align: right; margin-right: 100px;">* This is automatically reset when printing has been completed.</p>	15	14	13	12	11	10	09	08	07	06	05	04	03	02	01	00	0	0	0	0	0	0	0	0	0	0	0	0	0	0	0	0
15	14	13	12	11	10	09	08	07	06	05	04	03	02	01	00																		
0	0	0	0	0	0	0	0	0	0	0	0	0	0	0	0																		
n+1	Format table No. designation device Set the number of the format table (call setting) to be printed.																																

# MEMO

MONITOUCH



## **17 Barcode**

---

## 17.1 Overview

The V9 series reads barcode data, converts the necessary data into ASCII code, and stores the result in the specified PLC device memory address. This allows various types of information to be transferred immediately using a barcode reader. Also, the V9 series can show the read barcode data on the screen.

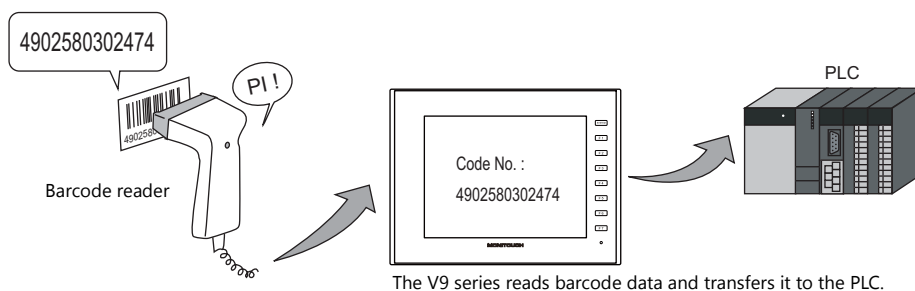

- The V9 series does not perform "handshake" processing with the barcode reader. (The barcode reader is not synchronized with the V9 series.)
- A barcode reader is connectable to either modular jack (MJ1 or MJ2), CN1, or the USB-A port of the V9 series.
- A 2D barcode reader can be connected for data read/write operations.
- The V9 series recognizes a barcode reader connection as a type of 8-way communication. This means that the setting procedure is the same as that for 8-way communication.

☞ For setting examples, refer to [page 17-2](#).

☞ For details on compatible barcode readers, refer to the following.

- Out website at: <http://www.monitouch.com/>
- V9 Series Connection Manual



### Note on serial connection

The cable for connecting the barcode reader to the V9 series differs depending on the type of barcode reader. Users should prepare an appropriate conversion cable if necessary.

☞ For details on wiring, refer to "17.4 Wiring" [page 17-7](#).

## 17.2 Setting Examples

The following describes the procedure for reading "CODE 39" barcode data using a barcode reader and transferring the data as ASCII codes to PLC device memory D1001.

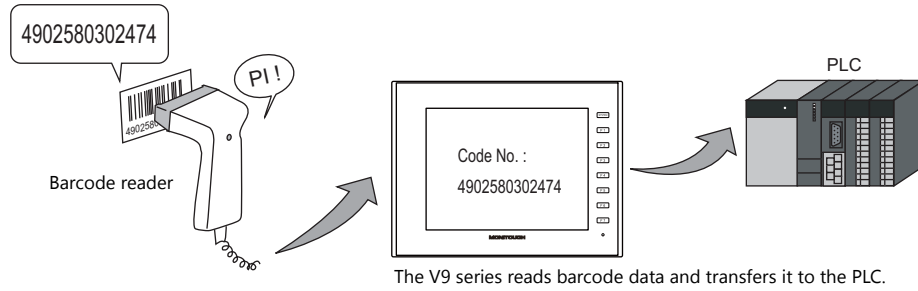

1. Click [System Setting] → [Hardware Setting] to display the [Hardware Setting] window.
2. Double-click an empty position between [PLC2] and [PLC8] and select "Barcode" for [Connected Device] and set [Target Port No.].

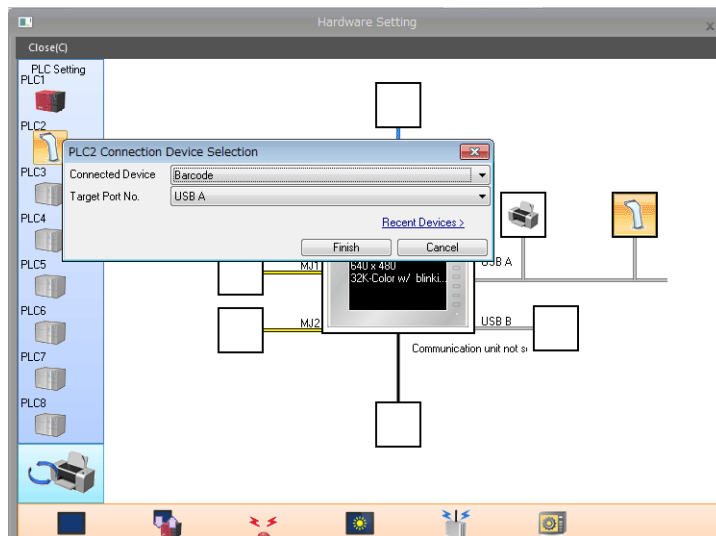

3. Set the parameters of the barcode reader in the [Barcode Properties] window. Set [I/F Device] to D1000.

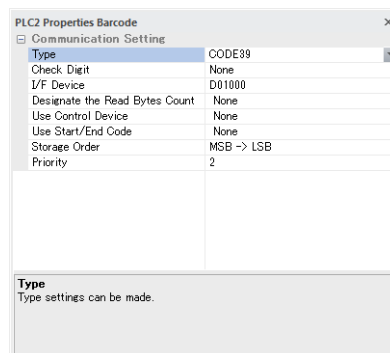

D1000: Flag/amount of data read  
D1001: Barcode data

For details, refer to "Detailed Settings" page 17-3.

4. Place a character display to display the read barcode data and set the PLC device memory to D1001.

This completes the necessary settings.

# 17.3 Detailed Settings

Location of settings: [System Setting] → [Hardware Setting] → “Barcode”

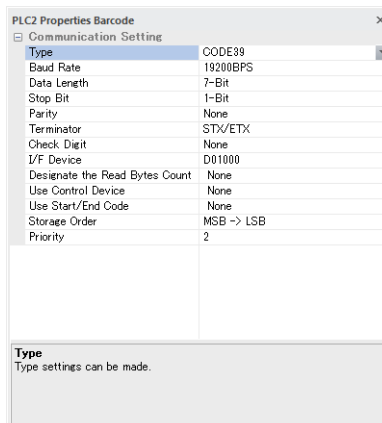

Item	Description																																
Type	Specify the type of barcode reader. JAN (UPC, EAN)/ITF (Interleaved 2 of 5)/CODABAR (NW-7)/CODE39/CODE128/ANY (2D barcode)																																
Baud Rate (serial connection)	Set the transmission speed.4800/9600/19200 BPS																																
Data Length (serial connection)	Set the number of bits for data. 7-Bit, 8-Bit																																
Stop Bit (serial connection)	Set the number of stop bits. 1-Bit, 2-Bit																																
Parity (serial connection)	Set the parity. None, Odd, Even																																
Terminator (serial connection)	Set the terminator.STX/ETX/CR/LF/CR																																
Check Digit	Set the check digit. None, Do Not Delete, Delete																																
I/F Device	This device memory stores the barcode data and the number of read bytes. Specify the top device memory address. For details, refer to <a href="#">page 17-4</a> .																																
Designate the Read Bytes Count	Specify the maximum number of bytes to be read. Always specify an even number of bytes. For details, refer to <a href="#">page 17-5</a> .																																
Use Control Device	Control reading operations of the barcode reader. When the 0th bit is set to “1” (permitted), store data using the I/F device memory. <table border="1" style="margin-left: 20px;"> <tr> <td>15</td><td>14</td><td>13</td><td>12</td><td>11</td><td>10</td><td>9</td><td>8</td><td>7</td><td>6</td><td>5</td><td>4</td><td>3</td><td>2</td><td>1</td><td>0</td> </tr> <tr> <td>0</td><td>0</td><td>0</td><td>0</td><td>0</td><td>0</td><td>0</td><td>0</td><td>0</td><td>0</td><td>0</td><td>0</td><td>0</td><td>0</td><td>0</td><td>0</td> </tr> </table> <div style="margin-left: 20px; margin-top: 5px;"> <span style="margin-left: 100px;">└── Not used (always set to “0”)</span> <span style="margin-left: 100px;">└── Read permission bit 0: Not permitted 1: Permitted</span> </div>	15	14	13	12	11	10	9	8	7	6	5	4	3	2	1	0	0	0	0	0	0	0	0	0	0	0	0	0	0	0	0	0
15	14	13	12	11	10	9	8	7	6	5	4	3	2	1	0																		
0	0	0	0	0	0	0	0	0	0	0	0	0	0	0	0																		
Use Start/End Code (Type: CODE 39)	Set whether or not to add a start and end code of “*” to the barcode data. Yes: Add an “*” code. None: Do not add an “*” code.																																
Storage Order	Set the order in which barcode data is stored in the I/F device memory. For details, refer to <a href="#">page 17-6</a> .																																
Priority	Set the order of precedence among PLC2 to PLC8.																																

## I/F Device

I/F device memory allocation is shown below.

### Type: JAN/ITF/CODABAR/CODE39/CODE128

Device Memory	Description																																
n	Flag / amount of data read <table border="1" style="margin-left: 20px;"> <tr> <td>15</td><td>14</td><td>13</td><td>12</td><td>11</td><td>10</td><td>9</td><td>8</td><td>7</td><td>6</td><td>5</td><td>4</td><td>3</td><td>2</td><td>1</td><td>0</td> </tr> <tr> <td>0</td><td></td><td>0</td><td></td><td>0</td><td>0</td><td></td><td></td><td></td><td></td><td></td><td></td><td></td><td></td><td></td><td></td> </tr> </table> <p style="margin-left: 40px;">                         1: Reading complete                          1: Communication error                          0 to 256 bytes: Amount of data read                     </p> <p>* All unused bits are reset to "0".</p>	15	14	13	12	11	10	9	8	7	6	5	4	3	2	1	0	0		0		0	0										
15	14	13	12	11	10	9	8	7	6	5	4	3	2	1	0																		
0		0		0	0																												
n + 1 - n + m	Data read (ASCII) * "0" (null code) is attached to the end of the data																																

### Type: ANY

Device Memory	Description																																
n	Flag <table border="1" style="margin-left: 20px;"> <tr> <td>15</td><td>14</td><td>13</td><td>12</td><td>11</td><td>10</td><td>9</td><td>8</td><td>7</td><td>6</td><td>5</td><td>4</td><td>3</td><td>2</td><td>1</td><td>0</td> </tr> <tr> <td>0</td><td></td><td>0</td><td></td><td>0</td><td>0</td><td>0</td><td>0</td><td>0</td><td>0</td><td>0</td><td>0</td><td>0</td><td>0</td><td>0</td><td>0</td> </tr> </table> <p style="margin-left: 40px;">                         1: Reading complete                          1: Communication error                          Not used (always set to "0")                     </p> <p>* All unused bits are reset to "0".</p>	15	14	13	12	11	10	9	8	7	6	5	4	3	2	1	0	0		0		0	0	0	0	0	0	0	0	0	0	0	0
15	14	13	12	11	10	9	8	7	6	5	4	3	2	1	0																		
0		0		0	0	0	0	0	0	0	0	0	0	0	0																		
n + 1	Amount of data read: 0 to 2,048 bytes																																
n + 2 - n + m	Data read (ASCII) * "0" (null code) is attached to the end of the data																																

### Flag details

Flag	Description
Communication error (bit 14)	When an error occurs in communication between the barcode reader and the V9 series, bit 14 changes to "1". Check that the barcode reader settings match the connected barcode reader and whether wiring has been performed correctly.
Reading complete (bit 12)	When data from the barcode reader is received and written to the I/F device memory, bit 12 (reading complete) changes to "1". Check that the bit is set to "1" and prepare for reading subsequent data. To read the next barcode data, reset the bit to "0" when the data has been read.
Amount of data read	The number of bytes read by the barcode reader is stored.

## Read Bytes Setting

The number bytes to be read depends on the setting for [Type] and [Read Bytes Setting].

Type	Read Bytes Setting	Number of Bytes Used
JAN ITF CODERBAR CODE39 CODE128	None	Variable for codes to be read, maximum of 254 bytes
	Selected	Fixed to the set number of words, 2 to 254 bytes
ANY	None	Variable for codes to be read, maximum of 2046 bytes
	Selected	Fixed to the set number of words, 2 to 2046 bytes

### Operation example

- I/F Device: D1000
- Read Bytes Setting: Selected
- No. of Bytes: 10 bytes
- Text Processing: LSB → MSB

- When data of "4902580302474" that exceeds 10 bytes is read:

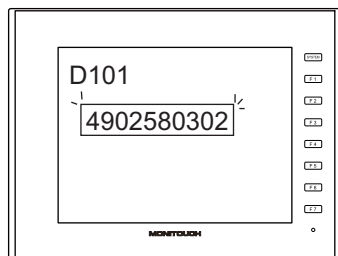

I/F Device	Value
D1000	Flag Amount of data read
D1001	3934HEX
D1002	3230HEX
D1003	3835HEX
D1004	3330HEX
D1005	3230HEX
D1006	Not used

10 bytes of data is stored and the remainder is deleted.

- When data of "12345" that is less than 10 bytes is read:

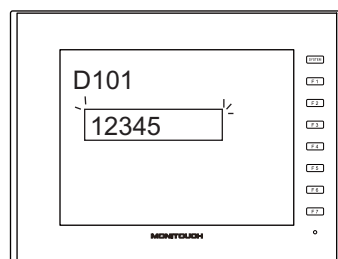

I/F Device	Value
D1000	Flag Amount of data read
D1001	3231HEX
D1002	3433HEX
D1003	0035HEX
D1004	0000HEX
D1005	0000HEX
D1006	Not used

"0" is stored as the HEX value in device memory addresses when there is no corresponding data.



## Storage Order

Data is read in the following manner according to the [Storage Order] setting.

Storage Order	Description
LSB → MSB	Data is read in the order of LSB → MSB 
MSB → LSB	Data is read in the order of MSB → LSB 

## Operation example

- I/F Device: D1000
- Barcode data: 4902580302474 (13 digits)

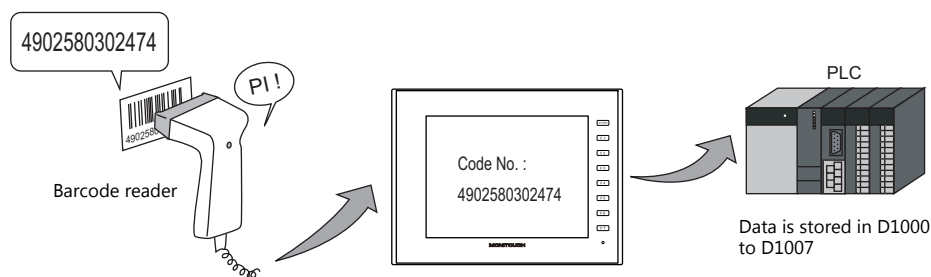

- Storage Order: LSB → MSB

I/F Device	Value (Description)
D1000	100DHEX (reading complete, 13 bytes)
D1001	3934HEX (94)
D1002	3230HEX (20)
D1003	3835HEX (85)
D1004	3330HEX (30)
D1005	3230HEX (20)
D1006	3734HEX (74)
D1007	0034HEX (04)

- Storage Order: MSB → LSB

I/F Device	Value (Description)
D1000	100DHEX (reading complete, 13 bytes)
D1001	3439HEX (49)
D1002	3032HEX (02)
D1003	3538HEX (58)
D1004	3033HEX (03)
D1005	3032HEX (02)
D1006	3437HEX (47)
D1007	3400HEX (40)

## 17.4 Wiring

### 17.4.1 USB Connection

Barcode readers connect to the USB-A port of the V9 series unit.  
Connect the barcode reader using the USB cable provided with the barcode reader.

### 17.4.2 Serial Connection

Use CN1 or a modular jack (MJ1/MJ2) to connect the barcode reader to the V9 series unit.

#### Connector: CN1

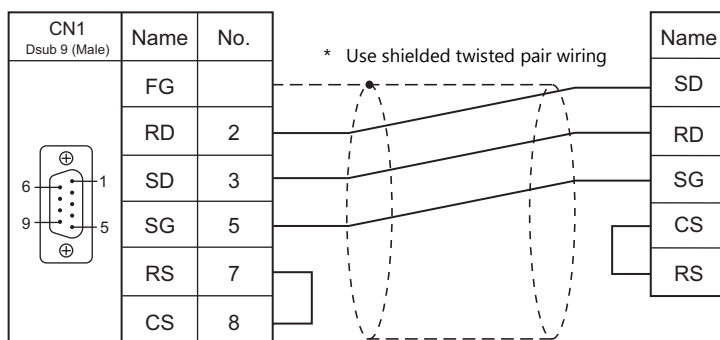

#### Modular jack: MJ1, MJ2



- For barcode readers with CS/RS control, it may be necessary to install a jumper between CS and RS to maintain proper operation.
- For details on the +5 V external power supply of MJ1/MJ2, refer to the V9 Series Hardware Specifications Manual.

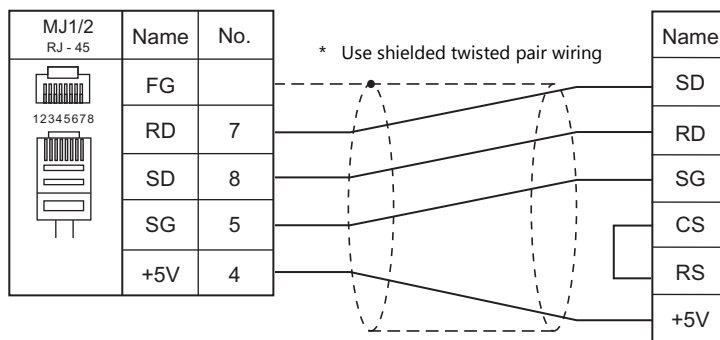

- \* When using Hakko Electronics' cable (model: V6-BCD)
  - Length: 3 m
  - With modular plug



## 17.5 Notes

---

- When connecting multiple USB devices to the V9 series, refer to the V9 Series Hardware Specifications Manual for precautions when using a USB hub.

**Hakko Electronics Co., Ltd.**  
**[www.monitouch.com](http://www.monitouch.com)**

**Sales** 890-1, Kamikashiwano-machi, Hakusan-shi, Ishikawa,  
924-0035 Japan  
TEL +81-76-274-2144 FAX +81-76-274-5136