

Hardware Specifications

MONITOUCH TS Series



Record of Revisions

Reference numbers are shown at the bottom left corner on the back cover of each manual.

Printing Date	Reference No.	Revised Contents
April, 2013	2022NE0	First edition

Preface

Thank you for selecting the Techno Shot series (TS series).

For correct set-up of the TS series, you are requested to read through this manual to understand more about the product.

The manuals shown below are related manuals for the TS series. Refer to them as necessary.

Manual Name	Contents	Reference No.
TS Series Training Manual	Screen configuration procedures using V-SFT version 5 are explained with examples.	1203NE
TS Series Connection Manual	Connecting the TS series with controllers and setting their communication parameters are explained.	2203NE
V8 Series Reference Manual	The functions and instructions of the V8 series are explained.	1055NE
V8 Series Reference: Additional Functions	Additional functions and operations of the V8 series that are available with V-SFT version 5.1.0.0 and later are explained.	1060NE
V Series Macro Reference	An overview of macros as well as macro editor operations and macro command descriptions are explained in detail.	1056NE
V8 Series Operation Manual	Information related to the operations of V-SFT version 5, such as software composition, editing procedure or limitations, is explained.	1058NE

For further details about controllers (PLCs, temperature controllers, etc.), refer to the manual issued by each controller manufacturer.

Notes:

1. This manual may not, in whole or in part, be printed or reproduced without the prior written consent of Hakko Electronics Co., Ltd.
2. The information in this manual is subject to change without prior notice.
3. Windows and Excel are registered trademarks of Microsoft Corporation in the United States and other countries.
4. All other company names or product names are trademarks or registered trademarks of their respective holders.
5. If the specifications of the software do not correspond with the contents of this manual, the software specifications have priority.

Notes on Safe Usage of TS Series

In this manual, you will find various notes categorized under the following levels with the signal words "DANGER" and "CAUTION".



DANGER

Indicates an imminently hazardous situation which, if not avoided, will result in death or serious injury.



CAUTION

Indicates a potentially hazardous situation which, if not avoided, may result in minor or moderate injury and could cause property damage.

Note that there is a possibility that the item listed with  CAUTION may have serious ramifications.



DANGER

- Never use the output signal of the TS series for operations that may threaten human life or damage the system, such as signals used in case of emergency. Please design the system so that it can cope with the malfunctions of a touch switch. A malfunction of a touch switch will result in machine accident or damage.
- Turn off the power supply when you set up the unit, connect new cables or perform maintenance or inspections. Otherwise, electrical shock or damage may occur.
- Never touch any terminals while the power is on. Otherwise, electric shock may occur.
- The liquid crystal in the LCD panel is a hazardous substance. If the LCD panel is damaged, do not ingest the leaked liquid crystal. If the liquid crystal spills on skin or clothing, wash off thoroughly with soap.
- Never disassemble, recharge, deform by pressure, short-circuit, reverse the polarity of the lithium battery, nor dispose of the lithium battery in fire. Failure to follow these conditions will lead to explosion or ignition.
- Never use a lithium battery that is deformed, leaks, or shows any other signs of abnormality. Failure to follow these conditions will lead to explosion or ignition.

 **CAUTION**

- Check the appearance of the unit when it is unpacked. Do not use the unit if any damage or deformation is found. Failure to do so may lead to fire, damage or malfunction.
- For use in a facility or for a system related to nuclear energy, aerospace, medical, traffic equipment, or mobile installations, please consult your local distributor.
- Operate (or store) the TS series under the conditions indicated in this manual and related manuals. Failure to do so could cause fire, malfunction, physical damage or deterioration.
- Understand the following environmental limits for use and storage of MONITOUCH. Otherwise, fire or damage to the unit may result.
 - Avoid locations where there is a possibility that water, corrosive gas, flammable gas, solvents, grinding fluids or cutting oil can come into contact with the unit.
 - Avoid high temperature, high humidity, and outside weather conditions, such as wind, rain or direct sunlight.
 - Avoid locations where excessive dust, salt, and metallic particles are present.
 - Avoid installing the unit in a location where vibration or physical shock may be transmitted.
- Equipment must be correctly mounted so that the main terminal of the TS series will not be touched inadvertently. Otherwise, an accident or electric shock may occur.
- Check periodically that terminal screws on the power supply terminal block and nuts are firmly tightened. Loosened screws or nuts may result in fire or malfunction.
- Tighten terminal screws on the power supply terminal block equally to a torque of 0.5 to 0.6 N•m (5 to 6 kgf•cm). Improper tightening of screws may result in fire, malfunction, or other serious trouble.
- Tighten the nuts on the TS series equally to the specified torque. Excessive tightening may distort the panel surface. Loose tightening may cause the unit to come off, malfunction or be short-circuited.
- The TS series has a glass screen. Do not drop or give physical shock to the unit. Otherwise, the screen may be damaged.
- Connect the cables correctly to the terminals of the TS series in accordance with the specified voltage and wattage. Over-voltage, over-wattage, or incorrect cable connection could cause fire, malfunction or damage to the unit.
- Be sure to establish a ground of the TS series. The FG terminal must be used exclusively for the unit with the level of grounding resistance less than 100 Ω . Otherwise, electric shock or a fire may occur.
- Prevent any conductive particles from entering into the TS series. Failure to do so may lead to fire, damage, or malfunction.
- Do not attempt to repair the TS series at your site. Ask Hakko Electronics or the designated contractor for repair.
- Do not repair, disassemble or modify the TS series. Hakko Electronics Co., Ltd. is not responsible for any damages resulting from repair, disassembly or modification of the unit that was performed by an unauthorized person.
- Do not use a sharp-pointed tool when pressing a touch switch. Doing so may damage the screen.
- Only experts are authorized to set up the unit, connect the cables or perform maintenance and inspection.
- Lithium batteries contain combustible material such as lithium or organic solvents. Mishandling may cause heat, explosion or ignition resulting in fire or injury. Read related manuals carefully and handle the lithium battery correctly as instructed.
- Do not press two or more positions on the screen at the same time. If two or more positions are pressed at the same time, the switch located between the pressed positions may be activated.
- Take safety precautions during such operations as setting change during running, forced output, start, and stop. Any misoperation may cause unexpected machine motions, resulting in machine accident or damage.
- In facilities where a failure of the TS series could lead to accident threatening human life or other serious damage, be sure that the facilities are equipped with adequate safeguards.
- At the time of disposal, the TS series must be treated as industrial waste.
- Before touching the TS series, discharge static electricity from your body by touching grounded metal. Excessive static electricity may cause malfunction or trouble.

[General Notes]

- Never bundle control cables nor input/output cables with high-voltage and large-current carrying cables such as power supply cables. Keep these cables at least 200 mm away from the high-voltage and large-current carrying cables. Otherwise, malfunction may occur due to noise.
- When using the TS series in an environment where a source of high-frequency noise is present, it is recommended that the FG shielded cable (communication cable) be grounded at its ends. However, the cable may be grounded only at one end if this is necessary due to unstable communication conditions or for any other reason.
- Plug connectors or sockets of the TS series in the correct orientation. Failure to do so may lead to damage or malfunction.
- Do not use thinners for cleaning because they may discolor the TS series surface. Use alcohol commercially available.
- If a data receive error occurs when the TS series and the counterpart (PLC, temperature controller, etc.) are started at the same time, read the manual for the counterpart unit and remove the error correctly.
- Avoid discharging static electricity on the mounting panel of the TS series. Static charges can damage the unit and cause malfunctions. Otherwise, malfunction may occur due to noise.
- Avoid prolonged display of any fixed pattern. Due to the characteristic of liquid crystal displays, an afterimage may occur. If prolonged display of a fixed pattern is expected, use the auto OFF function of the backlight.

[Notes on LCD]

Note that the following conditions may occur under normal circumstances.

- The response time, brightness and colors of the TS series may be affected by the ambient temperature.
- Tiny spots (dark or luminescent) may appear on the display due to the liquid crystal characteristics.
- Each unit varies slightly with respect to brightness and colors.

Contents

Preface

Notes on Safe Usage of TS Series

Chapter 1 Product Outline

1. Features.....	1-1
2. Models and Peripheral Equipment.....	1-3
Models.....	1-3
Peripheral Equipment.....	1-4
3. System Composition.....	1-5
TSi Series System Composition.....	1-5
TS Series System Composition.....	1-6

Chapter 2 Specifications

1. Specifications.....	2-1
General Specifications.....	2-1
Installation Specifications.....	2-2
Display Specifications.....	2-2
Touch Switch Specifications.....	2-2
Interface Specifications.....	2-3
Clock and Backup Memory Specifications.....	2-3
Drawing Environment.....	2-4
Display Function Specifications.....	2-4
Function Performance Specifications.....	2-5
2. Dimensions and Panel Cut-out.....	2-6
External Dimensions and Panel Cut-out Dimensions for TS1100.....	2-6
External Dimensions and Panel Cut-out Dimensions for TS1070.....	2-7
3. Names and Functions of Components.....	2-8
4. Serial Connector.....	2-10
COM1: RS-422/485 Communication Connector.....	2-10
COM2: RS-232C/COM3:RS-485 Communication Connector.....	2-11
5. USB Connector.....	2-12
USB-A (Master Port).....	2-12
USB-miniB (Slave Port).....	2-18
Securing USB Cables.....	2-23
Space for USB Connectors Behind the Unit.....	2-24
6. LAN Connector (TS1100i/TS1070i Only).....	2-25
LAN Connector.....	2-25
Wiring.....	2-25

Chapter 3 Installation

1. Mounting Procedure	3-1
Mounting Procedure	3-1
Mounting Angle	3-2
2. Power Supply Cable Connection	3-3
Power Supply Cable Connection	3-3

Chapter 4 Handling of TS Series Components

1. Coin-type Lithium Battery	4-1
Battery Usage	4-1
Time for Battery Replacement	4-1
Battery Replacement	4-1
Notes on Battery: EU Directive 2006/66/EC	4-5
2. DIP Switches	4-6
DIP Switch (DIPSW) Setting	4-6

Chapter 5 TS Series Operations

1. Before Operation	5-1
Procedure before Operation	5-1
Transferring Screen Data to TS Series for the First Time	5-2
2. Main Menu Screen	5-3
Displaying the Main Menu Screen	5-3
Main Menu Screen	5-4
[Main Menu] Switch	5-5
Main Menu Screen Composition	5-5
1. RUN	5-6
2. Language Selection	5-6
3. Communication Parameter	5-7
4. Ethernet (TS1100i/TS1070i Only)	5-8
4-1. IP Address Setting for the TS Series	5-9
5. SRAM/Clock	5-12
5-1. Date and Time Adjustment	5-13
5-2. Formatting SRAM	5-13
6. Extension Program Information	5-14
7. Storage Transfer	5-15
7-1. Storage Folder Configuration	5-17
7-2. Transferring Screen Data	5-18
7-3. Saving Backup Copies of SRAM	5-24
7-4. Storage Data Deletion	5-26
7-5. Message Dialog Displayed during Data Transfer (between TS and Storage)	5-27
8. Brightness Adjustment	5-28

9.	I/O Test.....	5-29
9-1.	Self-loop Test.....	5-30
9-2.	USB Test.....	5-34
9-3.	Print Test.....	5-34
9-4.	Touch Switch Test.....	5-35
9-5.	Keyboard Selection.....	5-37
10.	Extended Setting (TS1100i/TS1070i Only).....	5-38
10-1.	Registering/Unregistering the License for the Remote Desktop Function.....	5-39
11.	Extended Function Setting.....	5-41
11-1.	Setting Local Port Number.....	5-42
3.	System Menu.....	5-43
	Types of the System Menu Switches.....	5-43
	Functions of the System Menu Switches.....	5-43

Chapter 6 Error Handling

1.	Error Messages.....	6-1
1.	Communication Error.....	6-1
2.	Data Loading.....	6-2
3.	Warning.....	6-3
4.	Touch Switch Is Active.....	6-3
2.	Troubleshooting.....	6-4
	In the Event of an Error.....	6-4
	Probable Symptoms.....	6-4

Chapter 7 Inspection and Maintenance

1.	Inspection and Maintenance.....	7-1
	Daily Inspection.....	7-1
	Periodical Inspection.....	7-1
2.	Warranty Policy.....	7-2
	Inquiries about Failure.....	7-2
	Warranty Period.....	7-2
	Free-of-charge Repair.....	7-2
	Chargeable Repair.....	7-2
	Inquiry Form.....	7-3

1 Product Outline

1. Features
2. Models and Peripheral Equipment
3. System Composition

1. Features

The Techno Shot series (the TS series) features:

1. Low-cost standard model

The TS series is a high-performance low-cost model with a high degree of usability. This is a high-resolution, high-definition programmable display unit that offers 65,536 maximum displayable colors and WVGA (800 × 480 dots) resolution, incorporating a LCD with an LED backlight.

2. Ethernet-enabled (TS1100i and TS1070i only)

The TS series, while it is a low-cost model, supports Ethernet connection. The following network systems via Ethernet can be achieved with the TS series.

- Remote desktop

Screens on a server computer can be displayed on the TS series.

Computer functions become available even at worksites where computers cannot be brought in.

* Using the remote desktop function requires licensing.

- Network camera

Images taken by network cameras can be viewed on the TS series.

Angles of network cameras at remote locations can be changed by operation from the TS series.

- FTP server

The TS series can serve as the FTP server.

Via the FTP client tool in the computer, storage (e.g. USB memory) connected to the TS series can be accessed.

- MES interface

From the TS series via the remote monitoring software "V-Server", insertion, retrieval, deletion, and update can be executed on databases.

- TELLUS and V-Server Lite (remote maintenance software)*

TELLUS and V-Server Lite enable monitoring, operating, and gathering information from the TS series at remote locations.

* This software has minimum required functions, and is supplied with the V-SFT-5 (version 5.4.28.0 or later).

3. 8-way communication

A maximum of eight devices, such as PLCs or peripheral equipment, of different models or manufacturers can be connected to one unit of the TS series over a network in combination with Ethernet (max. 8 protocols) and serial communications (max. 3 protocols). A unit can communicate with eight types of devices at one time and exchange data among the connected devices.

Connection example: serial 3 ports + Ethernet

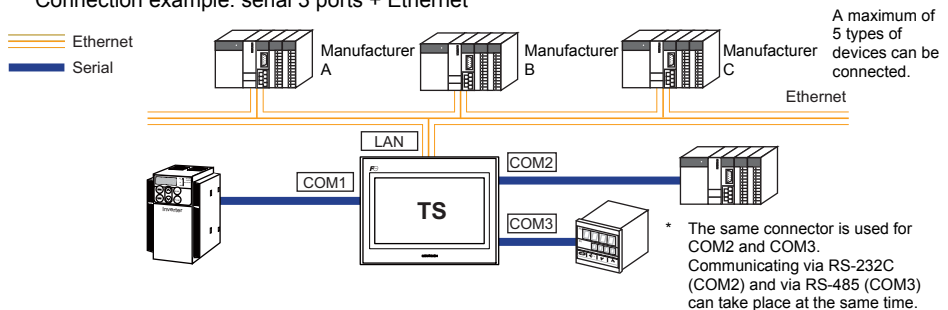

4. Handling operation logs
Logs of screen operations (operation logs) can be output to storage (e.g. USB memory).
If errors occur, such logs should be helpful for cause analysis.
Operation logs can be browsed on the TS series.
5. Security function
Screen display or operation can be controlled according to security levels set for screens or items.
Security levels can be changed at the time of user login.

2. Models and Peripheral Equipment

Models

The model name consists of the following information.

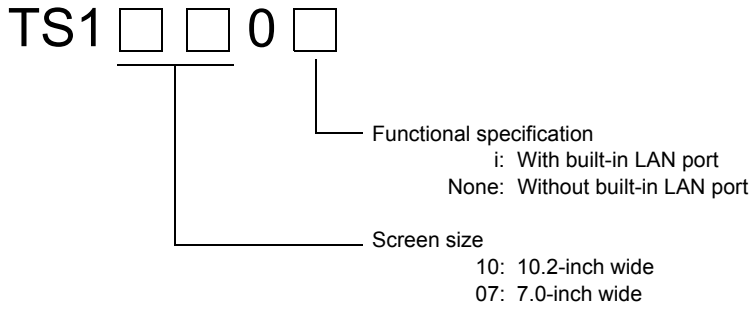

The series consists of the following models:

Analog resistance film type

Series	Model	Specifications	Remarks
TS1100 series 10.2-inch wide	TS1100	TFT color, 800 × 480 dots, without built-in LAN port, DC power supply	CE/KC approved
	TS1100i	TFT color, 800 × 480 dots, with built-in LAN port, DC power supply	
TS1070 series 7.0-inch wide	TS1070	TFT color, 800 × 480 dots, without built-in LAN port, DC power supply	
	TS1070i	TFT color, 800 × 480 dots, with built-in LAN port, DC power supply	

Peripheral Equipment

The following are the options for the TS series:

Drawing Tool

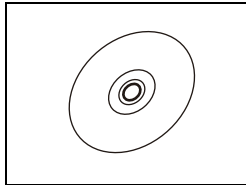

V-SFT-5 (configuration software)

Application software for editing screen data for MONITOUCH.
Use version 5.4.28.0 or later with the TS series.

Applicable OS:

Windows 98SE/NT4.0/Me/2000/XP/XP 64 Edition/Vista (32-bit, 64-bit)/7 (32-bit, 64-bit)/8 (32-bit, 64-bit)

Cables

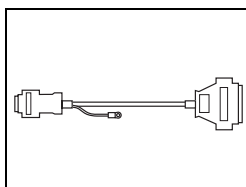

D9-D25 (D-sub 9-pin-to-25-pin conversion cable) 0.3 m

Conversion cable used for connecting the communication cable for the CN1 (D-sub 25-pin) in the V6/V7 series to the COM1 (D-sub 9-pin) in the TS series.

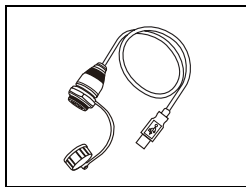

UA-FR (for USB-A port) 1 m

Cable for USB-A (master), with which connection from the front of the control cabinet is allowed.

Waterproof gasket

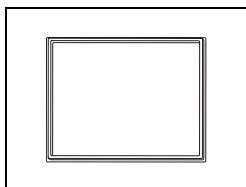

TS1xx0-WP

Waterproof gasket to make the front panel protection compliant with IP65.

TS1100-WP → TS1100 series

TS1070-WP → TS1070 series

Other Options

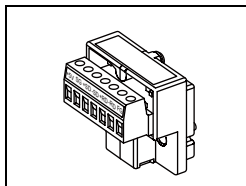

TC-D9 (terminal converter)

Used for connection between COM1 (D-sub 9-pin) of the TS series and a controller at the RS-422/485 terminal block.

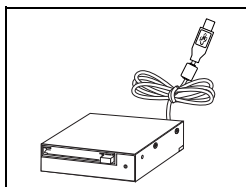

USB-CFREC (USB CF card recorder)

Unit that connects to the USB-A port and makes a CF card available.

3. System Composition

TSi Series System Composition

System configurations available with the TSi series:

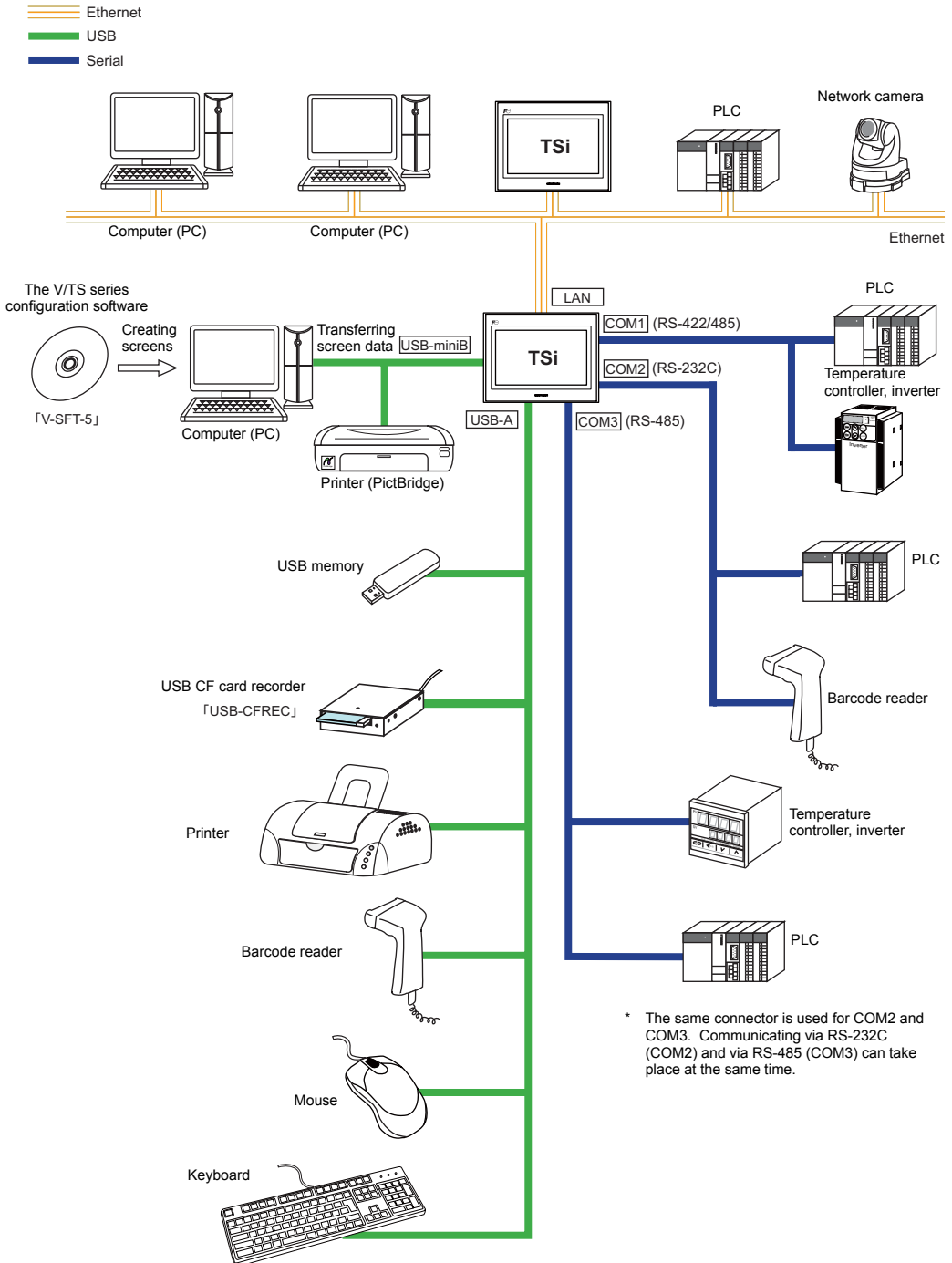

TS Series System Composition

System configurations available with the TS series:

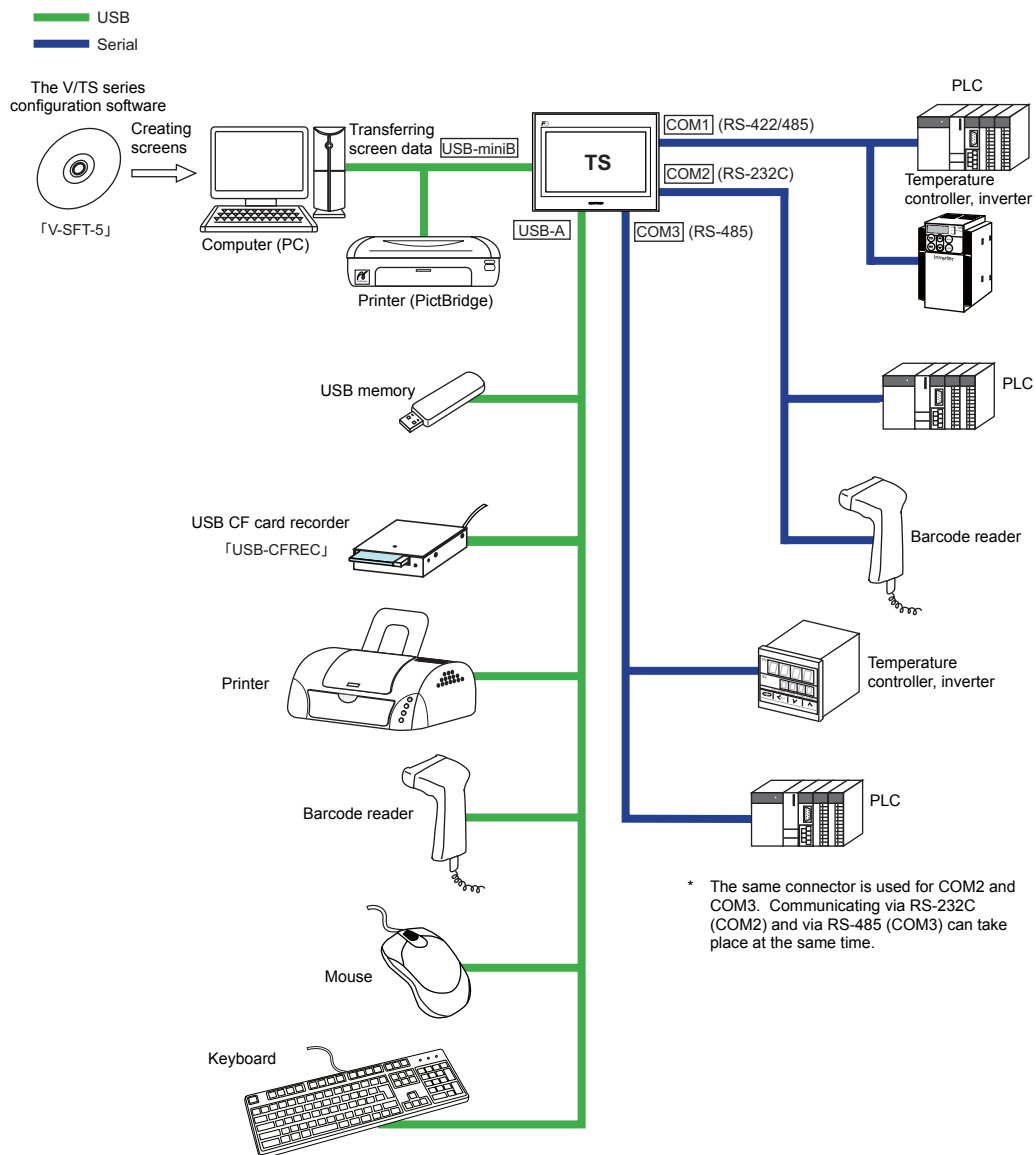

2 Specifications

1. Specifications
2. Dimensions and Panel Cut-out
3. Names and Functions of Components
4. Serial Connector
5. USB Connector
6. LAN Connector (TS1100i/TS1070i Only)

1. Specifications

General Specifications

Item		TS1100	TS1070
Standards		CE (EN61000-6-2, EN61000-6-4), KC	
Power Supply	Permissible Range of Voltage	24 VDC \pm 10 %	
	Permissible Momentary Power Failure	Within 1 ms	
	Power Consumption (Maximum Rating)	16.0 W or less	
	Rush Current	22 A or less (within 2 ms)	
	Withstand Voltage	DC external terminals to FG: 500 VAC, 1 minute	
Insulation Resistance		DC external terminals to FG: 500 VDC, 10 M Ω or above	
Physical Environment	Operational Ambient Temperature	0 °C to +50 °C *1	
	Storage Ambient Temperature	-10 °C to +60 °C *1	
	Operational Ambient Humidity	85 %RH or less (without dew condensation) *1	
	Storage Ambient Temperature	85 %RH or less (without dew condensation) *1	
	Altitude	2000 m or less	
	Atmosphere	No corrosive gas, no excessive dust, and no conductive dust	
	Contamination Level *2	Contamination level: 2	
Mechanical Working Conditions	Vibration Resistance	JIS B 3502 (IEC61131-2) compliant Vibration frequency: 5 to 9 Hz Half-amplitude: 3.5 mm, Vibration frequency: 9 to 150 Hz Constant acceleration: 9.8 m/s ² (1 G), 3 directions of X, Y, and Z: 10 times	
	Shock Resistance	JIS B 3502 (IEC61131-2) compliant Peak acceleration: 147 m/s ² (15 G), 3 directions of X, Y, and Z: 3 times each	
Electrical Working Conditions	Noise Resistance	Noise voltage: 1000 Vp-p, pulse width: 1 μ s, rising time: 1 ns (Measured by using a noise simulator)	
	Static Electricity Discharge Resistance	Compliant with IEC61000-4-2, contact: 6 kV, air: 8 kV	
Mounting Conditions	Weight	Approx. 1.5 kg	Approx. 0.9 kg
	Dimensions W \times H \times D	283.0 \times 220.0 \times 42.0 mm	215.0 \times 155.0 \times 42.0 mm
	Panel Cut-out Dimensions	257.0 ^{+0.5} \times 199.0 ^{+0.5} mm	189.0 ^{+0.5} \times 134.0 ^{+0.5} mm
Case Color		Black	
Material		PC / PS	

*1 Use MONITOUCH in the environment whose wet-bulb temperature is 39 °C or less. Otherwise, MONITOUCH may be damaged.

*2 This is an index that expresses the degree of conductive contamination in the environment where MONITOUCH is used.
"Contamination level 2" indicates the condition where only non-conductive contamination occurs. However, due to condensation, temporary conductive contamination may occur.

CE Marking

- The TS series complies with following EMC Directives:
EN61000-6-2, EN61000-6-4
- The TS series is identified as a class-A product in industrial environments. In the case of use in a domestic environment, the TS series is likely to cause electromagnetic interference. Preventive measures should thereby be taken as appropriate.

Installation Specifications

Item		Specifications
Grounding		Less than 100 Ω, FG/SG separated
Protection Structure	Front Panel *1	With waterproof gasket "TS1xx0-WP" (optional): IP65-compliant *2 Without waterproof gasket "TS1xx0-WP" (optional): IP40-compliant
	Rear Case	Compliant with IP20
Cooling System		Cooling naturally
Structure		Inserted in a mounting panel
Appropriate Mounting Panel Thickness		1.5 to 5 mm

*1 Protection structure for the front when the TS series is mounted on the mounting panel

*2 The strength differs depending on the material of the mounting panel. Check the environment where the TS series is used.

Display Specifications

Item	TS1100	TS1070
Display Device	TFT color	
Display Size	10.2-inch wide	7.0-inch wide
Colors	65,536 colors (without blinks) 32,768 colors (with blinks) 128 colors (with 16-color blinks)	
Display Resolution (W × H)	800 × 480 dots	
Dot Pitch (W × H)	0.2775 × 0.276 mm	0.192 × 0.1805 mm
Backlight	LED	
Backlight Life (average life of backlight only) *1	Approx. 40,000 hours	
Backlight Auto OFF Function	Always ON, random setting	
Brightness Adjustment	System menu: 3 levels Main Menu screen (Bright Adjustment screen): 128 levels Macro: 128 levels	
Surface Sheet Material	PET, 188 μm	

*1 Time until the surface brightness becomes 50 % of the initial value at an ambient temperature of 25 °C.

Touch Switch Specifications

Item	Specifications
Method	Analog resistance film type
Switch Resolution	1024 × 1024
Mechanical Life	One million activations or more
Surface Treatment	Anti-glare coating

Interface Specifications

Item		Specifications	
D-sub 9-pin (COM1/2/3)	COM1	Applicable Standards	RS-422 (4-wire connection) / RS-485 (2-wire connection) ^{*1}
		Synchronization	Asynchronous type
		Data Length	7- or 8-bit
		Parity	None, odd, even
		Stop Bit	1- or 2-bit
		Baud Rate	4800, 9600, 19200, 38400, 57600, 76800, 115 Kbps (For PPI/MPI connection with a Siemens PLC: 187.5 Kbps ^{*2})
	Applications	PLC, temperature controller, etc.	
	COM2 COM3	Applicable Standards	COM2: RS-232C / COM3: RS-485 (2-wire connection) ^{*3}
		Synchronization	Asynchronous type
		Data Length	7- or 8-bit
		Parity	None, odd, even
		Stop Bit	1- or 2-bit
Baud Rate		4800, 9600, 19200, 38400, 57600, 76800, 115 Kbps	
Applications	PLC, temperature controller, barcode reader, etc.		
USB Connector (USB-A / B)	USB-A	Applicable Standards	USB versions 2.0 and 1.1
		Baud Rate	Version 2.0: High-speed 480 Mbps Version 1.1: Low-speed 1.5 Mbps, full-speed 12 Mbps
		Applications	Printer (EPSON STYLUS PHOTO series), USB memory, USB-CFREC, keyboard, mouse, etc.
	USB-miniB	Applicable Standards	USB versions 2.0 and 1.1
		Baud Rate	Version 2.0: High-speed 480 Mbps Version 1.1: Low-speed 1.5 Mbps, full-speed 12 Mbps
		Applications	Screen data transfer, PictBridge-compatible printer
Ethernet Port 100BASE-TX / 10BASE-T (LAN) ^{*4}	Applicable Standards	IEEE802.3u (100BASE-TX), IEEE802.3 (10BASE-T)	
	Baud Rate	10 Mbps, 100 Mbps	
	Protocol	TCP/IP, UDP/IP	
	Functions	Auto-MDIX	
	Recommended cable ^{*5}	100 Ω UTP (unshielded twist-pair cable), category 5, max. 100 m long	
	Applications	Screen data transfer, PLC, etc.	

*1 Use DIP switches to switch between RS-422 (4-wire connection) and RS-485 (2-wire connection). For more information, refer to page 4-6.

*2 For more information, refer to the TS Series Connection Manual.

*3 The same connector is used for RS-232C and RS-485 (2-wire connection) ports. Communicating via RS-232C (COM2) and RS-485 (COM3) can take place at the same time.

*4 Provided as standard for TS1100i and TS1070i only

*5 Both straight and cross cables are usable, irrespective of the presence or absence of a hub.

Clock and Backup Memory Specifications

Item	Specifications
Battery Specification	Coin-type lithium primary cell (CR2032)
Backup Memory	SRAM 128 kbytes
Backup Period	3 years from the date of manufacturing (ambient temperature at 25 °C)
Calendar Accuracy	Monthly deviation ±5 sec (ambient temperature at 25 °C) [*]

* The range of deviation may increase, depending on the ambient temperature. Check and correct the clock periodically.

Drawing Environment

Item	Specifications
Drawing Method	Exclusive configuration software
Drawing Tool	Name of exclusive configuration software: V-SFT-5 (version 5.4.28.0 or later) Personal computer: Pentium III 800 MHz or above (Pentium IV 2.0 GHz or above recommended) OS: Windows 98SE/NT4.0/Me/2000/XP/XP 64 Edition/Vista (32-bit, 64-bit)/ 7 (32-bit, 64-bit)/ 8 (32-bit, 64-bit) Memory: 512 MB or more Hard disk capacity: Free space of approx. 1.5 GB or more CD-ROM disk drive: 24X or above recommended Display: Resolution 1024 × 768 or above Screen color: 16 bits or more Others: Microsoft .NET Framework 4.0 or 4.5 (If a PC running on Windows XP/Vista/7/8 does not have .NET Framework 4.0 or 4.5, Framework 4.0 will automatically be installed on the PC.)

Display Function Specifications

Item		Specifications				
Interface Language *1		Japanese	English/Western Europe	Chinese (Traditional)	Chinese (Simplified)	Korean
Characters	1/4-size, 1-byte	ANK code	Latin 1	ASCII code	ASCII code	ASCII code
	2-byte 16-dot	JIS #1, 2 levels	–	Chinese (traditional)	Chinese (simplified)	Hangul (without Kanji)
	2-byte 32-dot	JIS #1 level	–	–	–	–
Font		Bitmap font, Gothic font, Windows font				
Character Size	1/4-size	8 × 8 dots				
	1-byte	8 × 16 dots				
	2-byte	16 × 16 dots or 32 × 32 dots				
	Enlargement Factor	X: 1 to 8 times, Y: 1 to 8 times Point *2: 8, 9, 10, 11, 12, 14, 16, 18, 20, 22, 24, 26, 28, 36, 48, 72				
Number of Displayable Characters	Display Resolution	800 × 480 dots				
	1/4-size	100 characters × 60 lines				
	1-byte	100 characters × 30 lines				
	2-byte	50 characters × 30 lines				
Character Properties	Display Properties	Normal, reverse, blink, bold, shadow, transparent				
	Colors	65,536 colors (without blinks), 32,768 colors (with blinks), 128 colors (with 16-color blinks)				
Graphics	Lines	Line, continuous line, box, parallelogram, polygon				
	Circles	Circle, arc, sector, ellipse, elliptical arc				
	Others	Tile patterns				
Graphic Properties	Line Types	6 types (thin, thick, dot, chain, broken, two-dot chain)				
	Tile Patterns	16 types (including user-definable 8 patterns)				
	Display Properties	Normal, reverse, blink				
	Colors	65,536 colors (without blinks), 32,768 colors (with blinks), 128 colors (with 16-color blinks)				
	Color Selection	Foreground, background, boundary (line)				

*1 In addition, the following fonts are available.

Gothic, English/Western Europe HK Gothic, English/Western Europe HK Times, Central Europe, Cyrillic, Greek, Turkish, Baltic

For more information, refer to the V8 Series Reference Manual.

*2 Applicable when Gothic font is used.

With Windows fonts, the allowable number of points ranges from 6 to 999.

For more information on the number of points for Windows fonts, refer to the V8 Series Reference: Additional Functions.

Function Performance Specifications

Item		Specifications
Screens		Max. 4000
Screen Memory		Flash memory: Approx. 10.5 MB (variable depending on the font)
Switch		1024 per screen
Switch Actions		Set, reset, momentary, alternate, to light
Lamp		Reverse, blink, exchange of graphics 1024 per screen
Graph		Pie, bar, panel meter and closed area graph: No limitation ^{*1} Statistics and trend graphs: Max. 256 per layer ^{*2}
Data Setting	Numerical Data Display	No limitation ^{*1}
	Character Display	No limitation ^{*1}
	Message Display	No limitation ^{*1} Maximum number of characters per line: 100 one-byte characters
Sampling		Sampling display of buffer data (Constant sampling, bit synchronization, alarm logging, time order alarming, alarm function)
Graphic Library		Max. 2560
Overlap Library		Max. 4000
Data Blocks		Max. 1024
Messages		Max. 32768 lines
Patterns		Max. 1024
Macro Blocks		Max. 1024
Page Blocks		Max. 2048
Direct Blocks		Max. 1024
Screen Blocks		Max. 1024
Data Sheets		Max. 1024
Screen Library		Max. 4000
Comments		Max. 32767
Device Memory Map		Max. 32 × 8 (PLC1 to 8)
Time Display		Provided
Hard Copy		Provided
Buzzer		Provided, 3 sounds (short beep, long beep, continuous beep)
Auto OFF Function		Always ON, random setting
Self-diagnostic Function		Switch self-test function Communication parameter setting check function Communication check function

*1 The number of setting memory locations is limited to 1024 per screen.

*2 Layer: 5 layers per screen (base + 4 overlap displays including global overlap)

2. Dimensions and Panel Cut-out

External Dimensions and Panel Cut-out Dimensions for TS1100

- Front View

(Unit: mm)

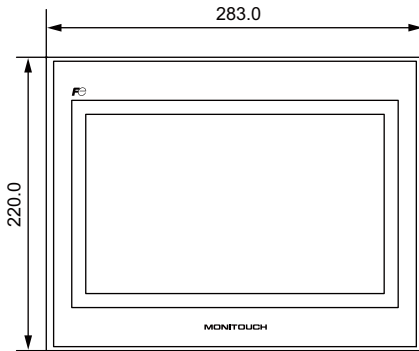

- Rear View

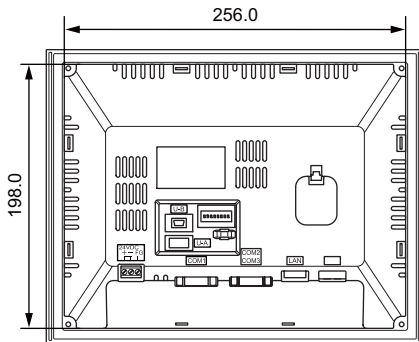

- Side View

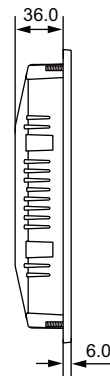

- Bottom View

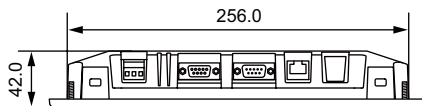

- Panel Cut-out Dimensions

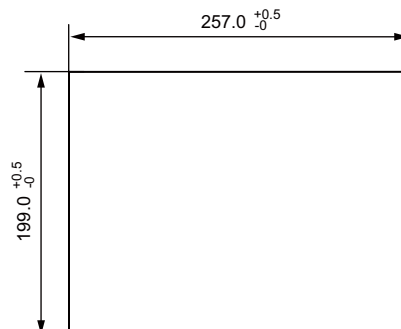

External Dimensions and Panel Cut-out Dimensions for TS1070

- Front View

(Unit: mm)

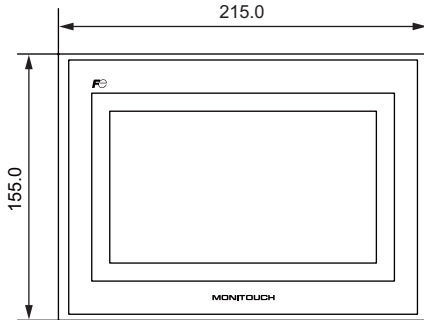

- Rear View

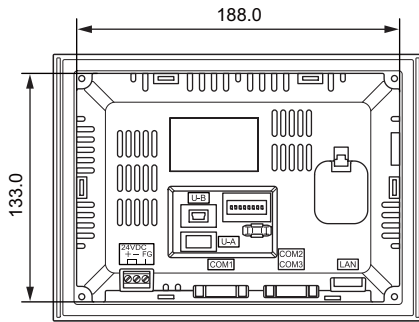

- Side View

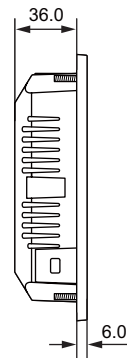

- Bottom View

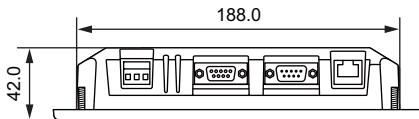

- Panel Cut-out Dimensions

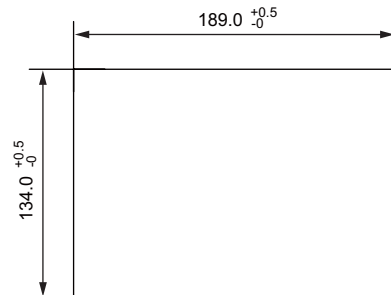

3. Names and Functions of Components

TS1100

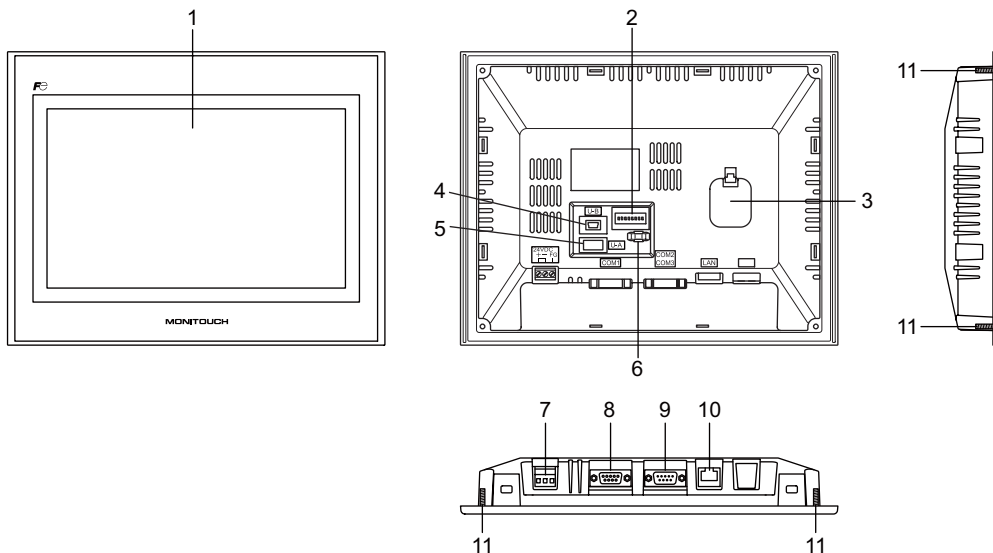

TS1070

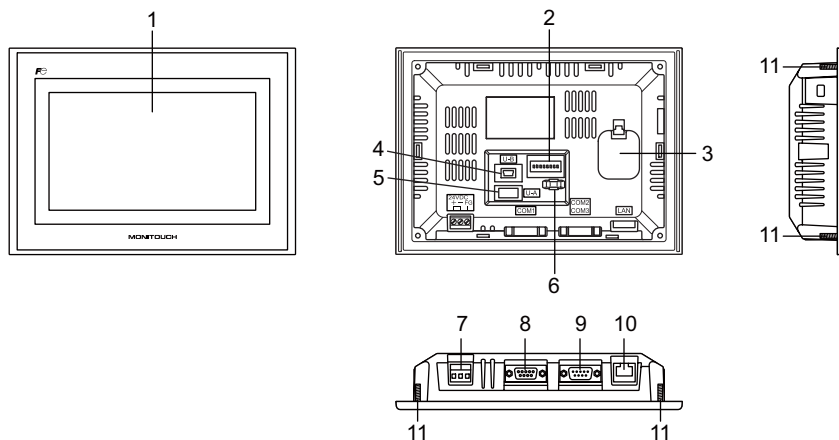

1. Display
This is the display unit.
2. DIP switches
Used to switch between RS-422 (4-wire connection) and RS-485 (2-wire connection) at COM1 or setting the terminal resistance of the RS-422/RS-485 signal line at COM1 or COM3.
3. Battery holder
Contains a backup battery for SRAM and clock.
Replace the battery when its voltage has decreased.
4. USB-miniB (slave port)
Used for screen data transfer or connection with a PictBridge-compatible printer.

5. USB-A (master port)
Used to connect a printer, a USB memory device, a USB CF card recorder USB-CFREC (optional unit), a keyboard, or a mouse.
6. USB cable clamp hole
Used to attach a USB cable tie.
7. Power supply terminal block
Used for power supply (24 VDC) to the TS series.
8. RS-422/RS-485 communication connector (COM1)
Used to connect a controller (such as PLC, temperature controller, or inverter) via RS-422 (4-wire connection) or RS-485 (2-wire connection).
9. RS-232C/RS-485 communication connector (COM2/COM3)
Used to connect a controller or a barcode reader via RS-232C or to connect a controller via RS-485 (2-wire connection).
10. 100BASE-TX/10BASE-T connector (LAN) for TS1100i and TS1070i only
Used for Ethernet connection.
11. Mounting screws
Used to attach fixtures for securing the TS series to the mounting panel.

4. Serial Connector

COM1: RS-422/485 Communication Connector

This connector is used to connect a controller via RS-422 (4-wire connection) or RS-485 (2-wire connection).

- TS1100

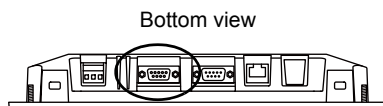

- TS1070

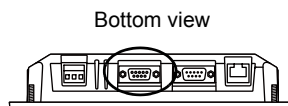

The serial connector pins (COM1) correspond to signals as given below.

COM1 (D-sub 9-pin, female)	Pin No.	Signal	Contents
	1	+RD	Receive data (+)
	2	-RD	Receive data (-)
	3	-SD	Send data (-)
	4	+SD	Send data (+)
	5	SG	Signal ground
	6	NC	Not used
	7		
	8		
	9		

* Use DIP switches 2 and 3 to switch between RS-422 (4-wire connection) and RS-485 (2-wire connection). Setting the DIP switches 2 and 3 to ON connects +RD with +SD, and -RD with -SD in the TS unit. For more information on DIP switches, refer to page 4-6.

Recommended Connector

The following connector is recommended for a self-made cable.

Recommended connector	DDK's 17JE-23090-02(D8C)-CG	D-sub 9-pin / male / inch screw thread (#4-40UNC) type / with hood / lead- and cadmium-free
-----------------------	-----------------------------	---

Connection with PLC/Temperature Controller

The PLC or temperature controller can be connected.

For details on available models or settings on the V-SFT-5, refer to the TS Series Connection Manual.

COM2: RS-232C/COM3:RS-485 Communication Connector

This connector is used to connect a controller or a barcode reader via RS-232C or to connect a controller via RS-485 (2-wire connection).

Communicating via RS-232C (COM2) and RS-485 (COM3) can take place at the same time.

- TS1100

Bottom view

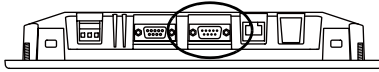

- TS1070

Bottom view

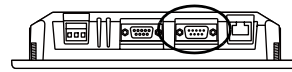

The serial connector pins (COM2/COM3) correspond to signals as given below.

COM2/COM3 (D-sub 9-pin, male)	Pin No.	RS-232C (COM2)		RS-485 (COM3)	
		Signal	Contents	Signal	Contents
	1	-	-	-SD/RD	Send/receive data (-)
	2	RD	Receive data	-	-
	3	TD	Send data	-	-
	4	NC	Not used	-	-
	5	SG	Signal ground	-	-
	6	-	-	+SD/RD	Send/receive data (+)
	7	RTS	Request to send	-	-
	8	CTS	Permission to send	-	-
	9	-	-	SG	Signal ground

Recommended Connector

The following connector is recommended for a self-made cable.

Recommended connector	DDK's 17JE-13090-02(D8C)A-CG	D-sub 9-pin / female / inch screw thread (#4-40UNC) type / with hood / lead- and cadmium-free
-----------------------	------------------------------	---

Connection with PLC/Temperature Controller

The PLC or temperature controller can be connected.

For details on available models or settings on the V-SFT-5, refer to the TS Series Connection Manual.

Connection with Barcode Reader

The barcode reader can be connected to read barcode data.

For details on settings on the V-SFT-5, refer to the TS Series Connection Manual.

5. USB Connector

USB-A (Master Port)

This connector is used to connect a printer, a USB memory device, a USB-CFREC, a barcode reader, a keyboard, a mouse, or a USB hub.
 The USB-A port on the TS series complies with USB versions 2.0 and 1.1.

- TS1100

Rear view

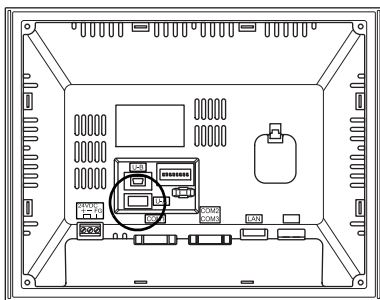

- TS1070

Rear view

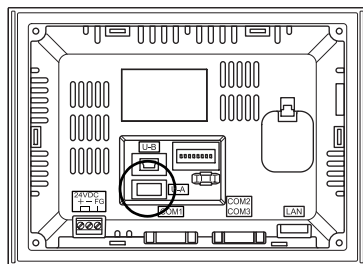

Enlarged view

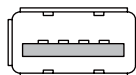

Printer

By connecting a printer to the TS series, screen data, historical data, or data sheets can be printed out.

Connection Example

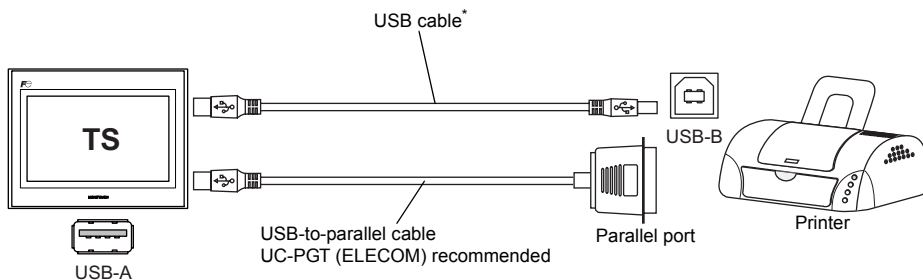

* Use the cable included with the printer.

Available Printer

Model*	Port on the Printer Side	Cable
PR-201 ESC-P	Parallel port	UC-PGT
EPSON STYLUS PHOTO series EPSON PX-V600/700 EPSON PX-V500	Parallel port	UC-PGT
	USB-B	USB cable

* For more information on available printers, visit our website (<http://www.monitouch.com>).

V-SFT-5 Setting

Click [System Setting] → [Device Connection Setting] → [Others] → [Printer]. In the tab window, select [USB A] for [Connect to:] and a desired option for [Type].

USB Memory

By inserting a USB memory device (commercially available) into the TS series, the device can be used for screen data transfer or historical data saving.

Connection Example

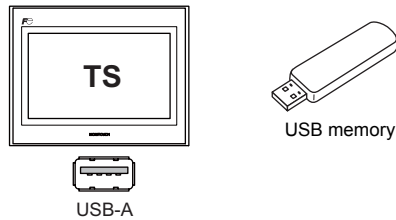

V-SFT-5 Setting

Click [System Setting] → [Storage Setting]. In the dialog, select [USB Port] for [Storage Connection Target].

Notes on Handling the USB Memory

1. The TS series can recognize USB memory in FAT or FAT32 file systems.
2. Do not turn off the unit while the TS series is accessing the USB memory.
3. Make a backup copy of the USB memory at regular intervals.
4. If a disk error occurs and data read/write operation is disabled, execute ScanDisk on Windows and try to restore the device.
If not restored, format the device. Note that formatting will completely delete any stored data. (For information on executing ScanDisk on Windows, refer to the manual for Windows.)
5. The number of write cycles for a USB memory is limited. Consequently, frequent writing at short intervals may shorten the service life of the USB memory. When using USB memory to save sampling data, be aware of the sampling time. Also, avoid repeated writing using a CYCLE macro command.
6. When disconnecting the USB memory, open the Main Menu screen or hold down the [Storage Removal] switch on the screen.

USB CF Card Recorder (USB-CFREC)

By connecting a USB-CFREC to the TS series, a CF card can be used for screen data transfer or historical data saving.

Connection Example

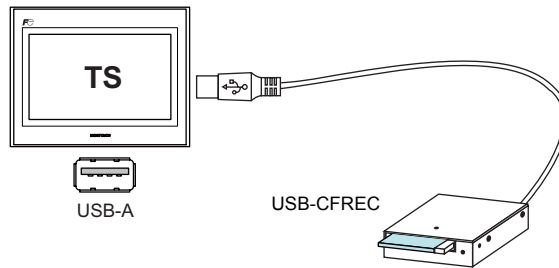

V-SFT-5 Setting

Click [System Setting] → [Storage Setting]. In the dialog, select [USB Port] for [Storage Connection Target].

Notes on Handling the CF Card

1. The TS series can recognize CF cards in FAT or FAT32 file systems.
2. Do not turn off the unit while the TS series is accessing the CF card.
3. Make a backup copy of the CF card at regular intervals.
4. If a disk error occurs and data read/write operation is disabled, execute ScanDisk on Windows and try to restore the device.
If not restored, format the device. Note that formatting will completely delete the stored data. (For information on executing ScanDisk on Windows, refer to the manual for Windows.)
5. The number of write cycles per CF card is limited (approx. 300,000 times). Consequently, frequent writing at short intervals may shorten the service life of the CF card. When using a CF card to save sampling data, be aware of the sampling time. Also, avoid repeated writing using a CYCLE macro command.
6. When disconnecting the CF card, open the Main Menu screen or hold down the [Storage Removal] switch on the screen.
7. When inserting a CF card, take care not to invert the card (make a distinction between its front and back).
If a CF card is inserted upside down into the USB-CFREC, the card, the data stored on the card, or the socket of the USB-CFREC may be damaged.

Barcode Reader

By connecting a barcode reader to the TS series, barcode data can be read through the barcode reader.

Connection Example

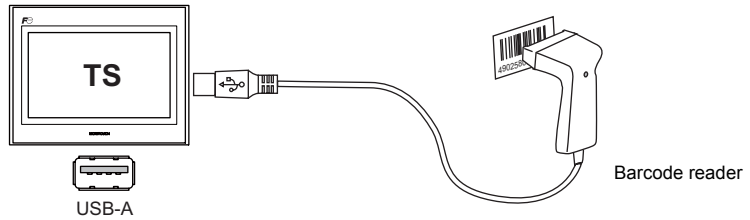

Available Barcode Reader

A USB-HID-compliant barcode reader can be connected.
For details on barcode readers of which operations have been verified, visit our website (<http://www.monitouch.com>).

V-SFT-5 Setting

Click [System Setting] → [Device Connection Setting] → [PLC n: Barcode]. Select [USB A] for [Connect to:]. In the [Communication Setting] tab window, select an option for [Type].

Keyboard

Numerals or characters can be entered by connecting a keyboard or a numeric keypad to the TS series.

Connection Example

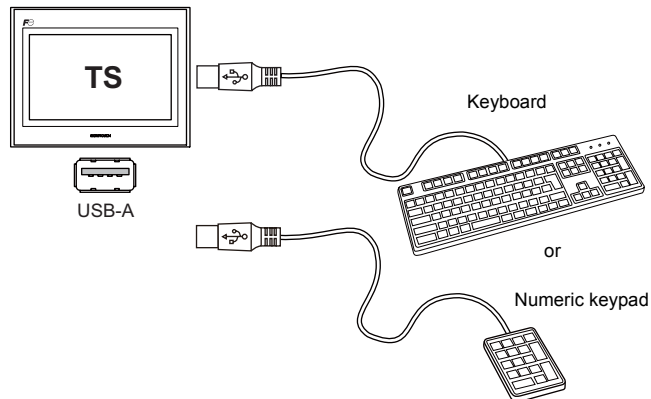

Available Keyboard

Type	Remarks
Japanese keyboard	106 keyboard, 109 keyboard, etc.
US standard keyboard	101 keyboard, 104 keyboard, etc.
Numeric keypad	

V-SFT-5 Setting

An [Entry] icon must be registered on the screen where the keyboard is to be used.
In addition, numerical data or character display parts of [Display Function: Entry Target] are required.
For more information, refer to the V8 Series Reference: Additional Functions.

TS Unit Setting

On the Main Menu screen, select a type of the keyboard to be connected.
For details, refer to “Keyboard Selection” page 5-37.

Mouse

By connecting a mouse to the TS series, the mouse can be used to operate screens displayed on the unit.

Connection Example

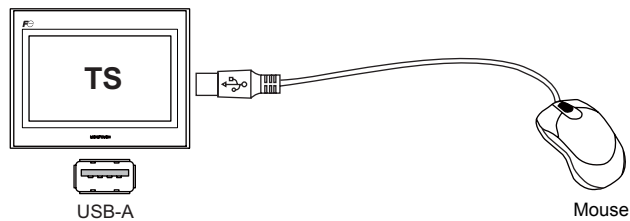

For more information, refer to the V8 Series Reference: Additional Functions.

USB Hub

By connecting a USB hub to the TS series, devices like a printer or a USB-CFREC can be used at the same time.

Connection Example

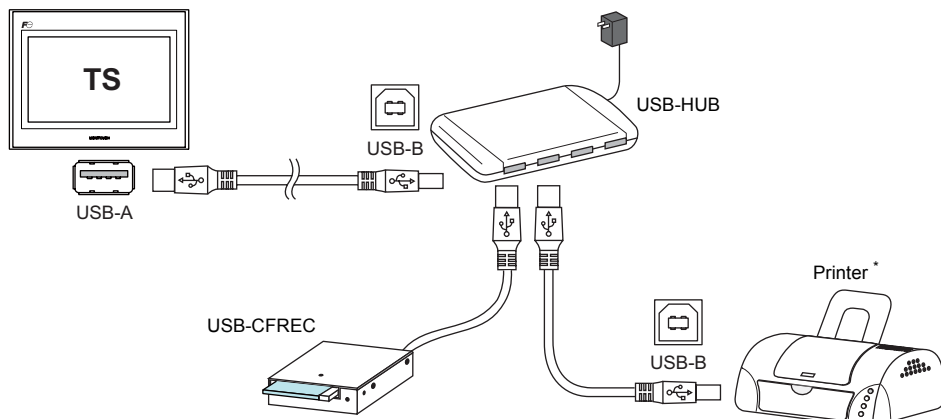

* A parallel printer can also be connected (on conditions that the model is available with the TS series and connected with a commercially available parallel-to-USB cable (ELECOM's UC-PGT recommended)). For more information on available printer models, visit our website (<http://www.monitouch.com>).

V-SFT-5 Setting

Refer to the previous "V-SFT-5 Setting":

- Printer (page 2-12)
- USB Memory (page 2-13)
- USB CF Card Recorder (USB-CFREC) (page 2-14)
- Barcode Reader (page 2-15)
- Keyboard (page 2-15)

Notes

- A barcode reader and a keyboard cannot be connected to a USB hub at the same time.
- Two or more barcode readers or keyboards cannot be connected to a USB hub at the same time.
- A maximum of two USB hubs can be connected (cascaded) to the TS unit.
Note that performance will decrease when two USB hubs are connected.
- When a USB hub connected to the TS unit is powered through its accessory power supply adaptor, do not turn off the adaptor or disconnect the connector between the adaptor and the USB hub.
Doing so may cause insufficient power supply to the TS unit resulting in faulty operation such as repeated restarting.
- When connecting two USB hubs to the TS unit, supply the power to each USB hub using its accessory power supply adaptor.
Even when connecting only one USB hub, use its power supply adaptor (if the one is supplied with a hub).
- Before disconnecting the USB memory device or the USB cable of the USB CF card recorder USB-CFREC, open the Main Menu screen on the unit or hold down the [Storage Removal] switch on the screen.

USB-miniB (Slave Port)

This connector is used for screen data transfer or connection with a PictBridge-compatible printer. The USB-miniB port on the TS series complies with USB versions 2.0 and 1.1.

- TS1100

Rear view

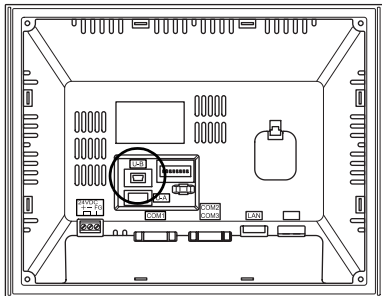

- TS1070

Rear view

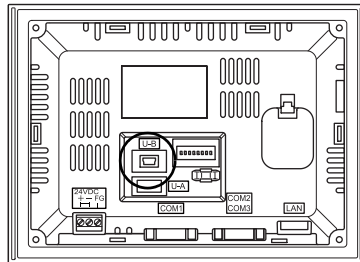

Enlarged view



Printer (PictBridge)

Screen hard copy, historical data or data sheet can be printed out from the PictBridge-compatible printer.

Connection Example

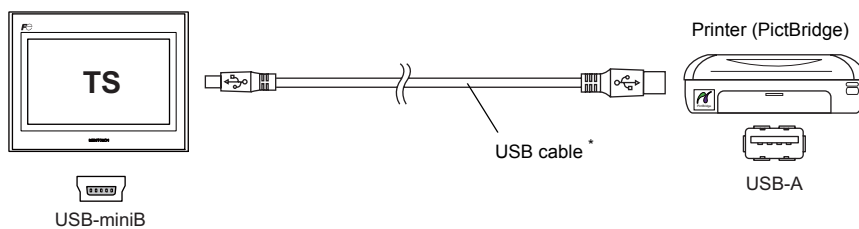

* Use a commercially available USB cable. You are recommended to use a shielded twist-pair USB cable of 5 m in length.

Available Printer

Any PictBridge-compatible printer can be connected.

V-SFT-5 Setting

Select [System Setting] → [Device Connection Setting] → [Others] → [Printer], and select "PictBridge" for [Type] in the [Printer] tab window.

Transferring Screen Data

Screen data can be transferred via USB-miniB (USB slave port).

Be sure to install the dedicated USB driver for the TS series on the computer. For the installation procedure, refer to "Installation Procedure of the Driver for Screen Data Transfer" on (page 2-19).

Connection Example

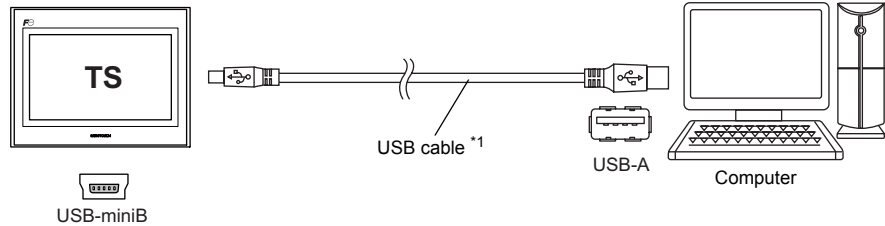

*1 Use a commercially available USB cable. You are recommended to use a shielded twist-pair USB cable of 5 m in length.

Installation Procedure of the Driver for Screen Data Transfer

- For Windows Vista/7/8
 1. Connect the USB-mini B port of the TS series (with power on) to the computer (with power on) using a USB cable.
 2. The USB driver is automatically installed. During installation, the following message is displayed on the computer's taskbar.

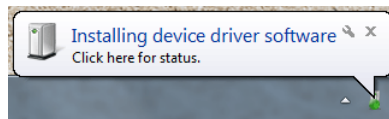

3. The following message is displayed on the computer's taskbar when installation is finished. If installation has terminated due to an error, reinstall the USB driver. See page 2-21.

- When successfully completed

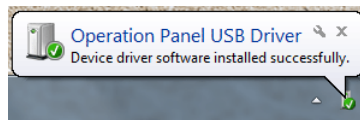

- When terminated due to error

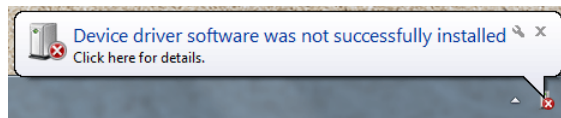

- For Windows XP
 1. Connect the USB-mini B port of the TS series (with power on) to the computer (with power on) using a USB cable.
 2. The message "Found New Hardware" and then the driver installation wizard appear on the computer.
Select [No, not this time] and click the [Next] button.

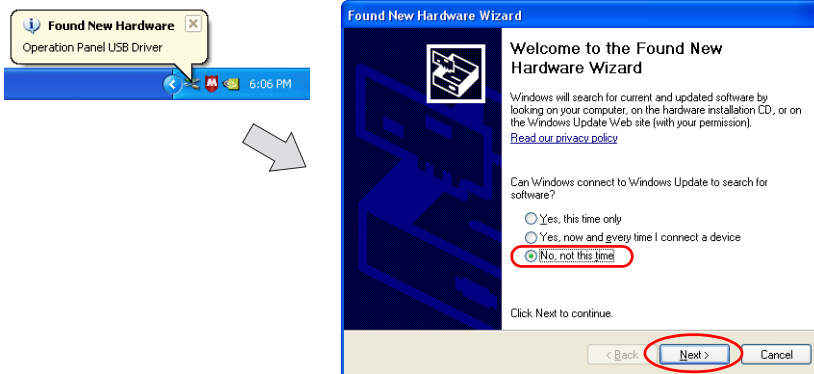

3. Select [Install the software automatically (Recommended)] on the [Hardware Update Wizard] and click [Next].

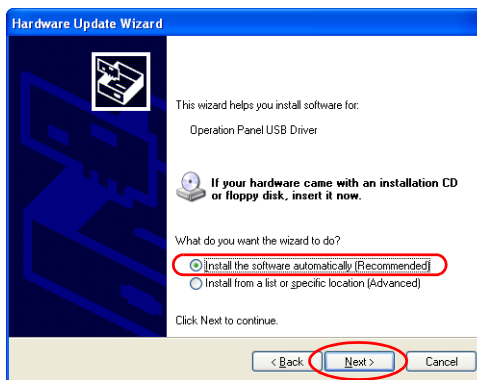

4. Installation of the USB driver starts.

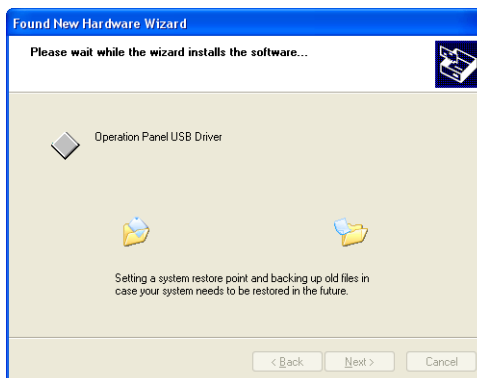

- Click the [Finish] button on the screen below.

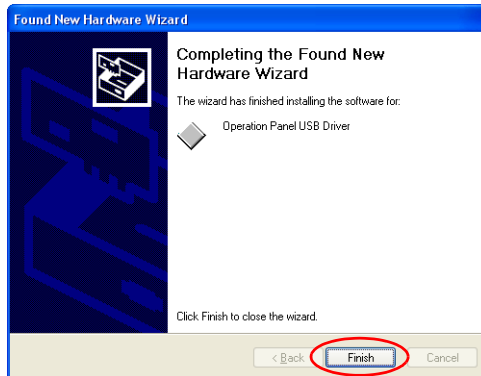

- For OSs earlier than Windows XP
For more information, refer to the V8 Series Operation Manual.
- When USB driver installation fails
If automatic installation of the USB driver fails, perform installation by the following procedure.
 - Open the following folder from [My Computer] or [Windows Explorer].
 - For Windows Vista/7/8
C:\MONITOUCH\V-SFT V5\INF
 - For Windows XP
C:\Program Files\V-SFT V5\INF
 - Double-click "V-SFTV5_USBDriver.exe".

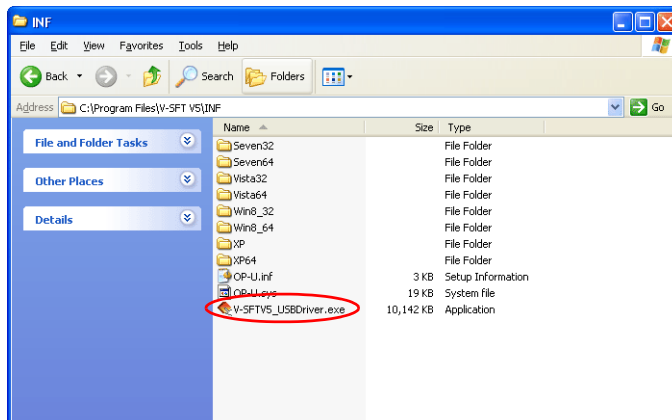

Depending on your computer, the following dialog may be displayed when using Windows Vista/7/8. Click the [Yes] button.

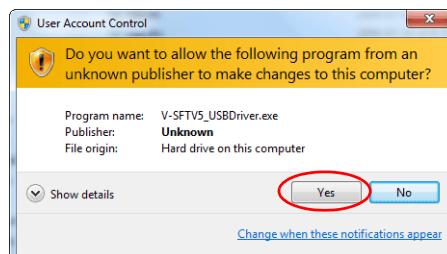

3. Click the [Next] button on the screen below. Installation of the USB driver starts.

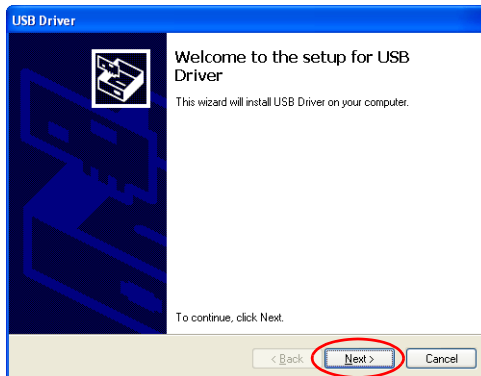

4. Click the [Finish] button on the screen below.

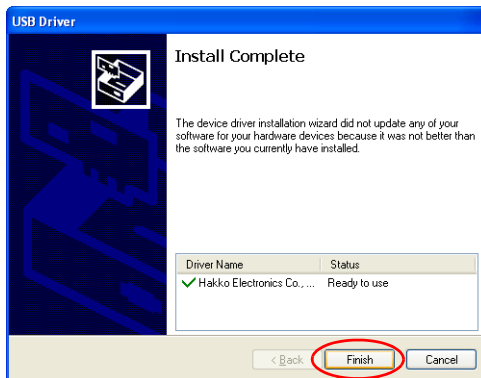

USB driver installation is complete.

Recognition of USB Driver

When the driver has been installed successfully, the [Device Manager] window shows "Operation Panel - Operation Panel USB Driver".

- For Windows Vista/7/8
- For Windows XP

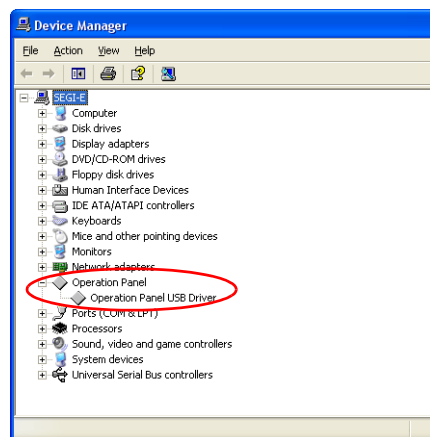
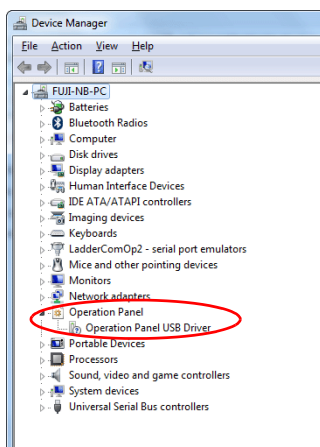

This will disappear when MONITOUCH and computer are disconnected. If [Other Device] or a mark other than shown above is displayed even while the USB is connected, the USB driver is not recognized. If this happens, uninstall the USB driver and reinstall it.

Securing USB Cables

A USB cable may be disconnected from the TS unit depending on the mounting condition. Using the cable tie supplied with the unit should prevent such a problem.

Securing the USB Cable

1. Preparing a cable tie
Draw a cable tie through the hole as shown in the figure below.

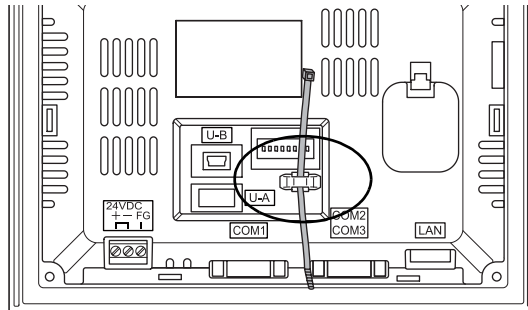

2. Inserting and securing a USB cable
Insert a USB cable and secure it using the cable tie.

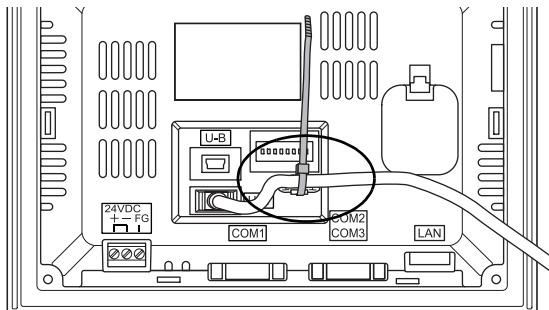

The following figures show cases where only USB-miniB is used and where both USB-A and USB-miniB are used.

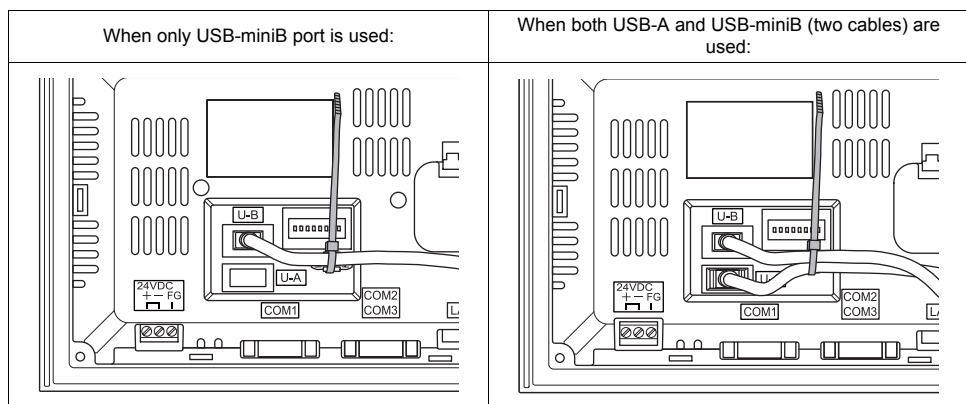

Space for USB Connectors Behind the Unit

On the TS series, ports to connect USB cables or USB memory are provided on its backside. Because of this design, space is needed behind the unit. To allow connection of USB cables or USB memory, leave 150.0 mm (or more) of space to the rear of the TS unit.

Example: A USB cable (with ferrite core) connected

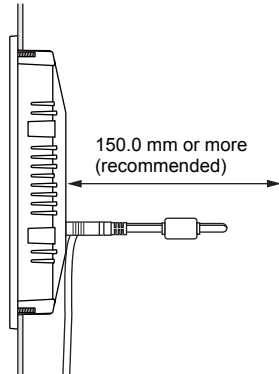

6. LAN Connector (TS1100i/TS1070i Only)

LAN Connector

This connector is used to connect a controller via Ethernet.
The LAN connector supports 100BASE-TX/10BASE-T.

- TS1100

Bottom view

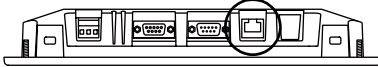

- TS1070

Bottom view

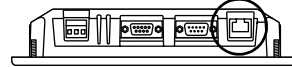

The LAN connector pins correspond to signals as given below.

Specification: IEEE802.3 (u)-compliant, supporting UDP/IP, TCP/IP, and Auto-MDIX

LAN	Pin No.	Signal	Contents
	1	TX+	Ethernet send signal (+)
	2	TX-	Ethernet send signal (-)
	3	RX+	Ethernet receive signal (+)
	4	NC	Not used
	5	NC	Not used
	6	RX-	Ethernet receive signal (-)
	7	NC	Not used
	8	NC	Not used

The LAN connector is associated with LEDs as given below.

LAN	LED Status		Contents
	Green	Orange	
	ON	ON	Connected via 100 BASE-TX
	ON	OFF	Connected via 10 BASE-T
	Blinking	ON/OFF	Sending/receiving data

Wiring



CAUTION

When using the LAN port, keep the LAN cable away from the power supply cable as much as possible.

Use a commercially available cable. Using a self-made cable may cause an error in network connection.

Recommended cable: 100 Ω UTP (unshielded twist-pair) cable, category 5, max. 100 m long

* Both straight and cross cables are usable, irrespective of the presence or absence of a hub.

MEMO

Please use this page freely.

3 Installation

1. Mounting Procedure
2. Power Supply Cable Connection

1. Mounting Procedure

Mounting Procedure

1. Insert the TS unit into the mounting panel (max. thick: 5 mm).

* When using an optional waterproof gasket "TS1xx0-WP", firmly sandwich the gasket between the mounting panel and the TS series.

Panel cut-out hole

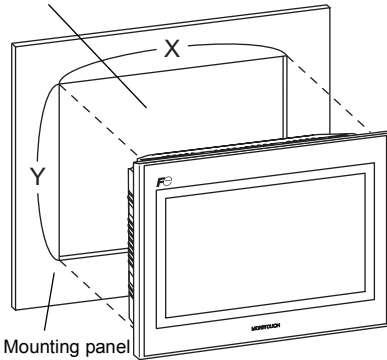

Panel cut-out dimensions

Model	X	Y
TS1100	257.0 ^{+0.5} ₋₀	199.0 ^{+0.5} ₋₀
TS1070	189.0 ^{+0.5} ₋₀	134.0 ^{+0.5} ₋₀

Unit: mm

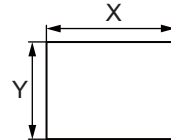

2. Fit the supplied four fixtures onto the screws of the TS series. Tighten them with the supplied four nuts. (Tightening torque: 0.3 to 0.4 N·m)

* When the TS unit is attached to the mounting panel, the fixtures and frame grounds (FG) are connected.

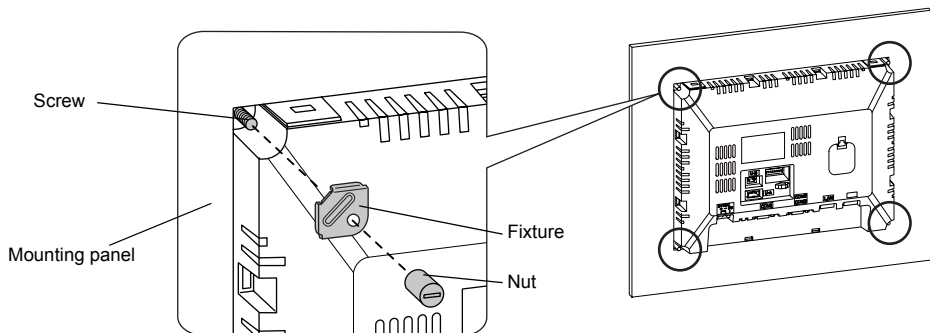

- Nut dimensions

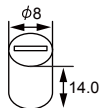

- Fixture dimensions

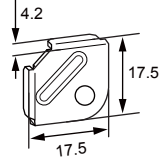

- Dimensions of a tightened fixture that lies off the edges of the TS unit (Unit: mm)

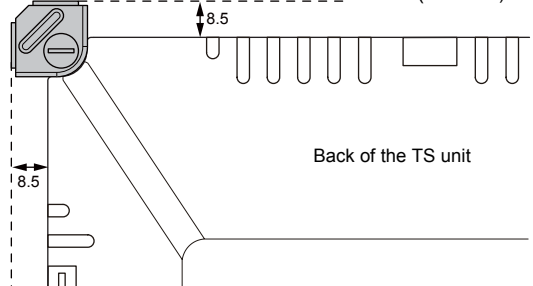

Mounting Angle

Install the unit within the angle of 15° to 135° as shown below.

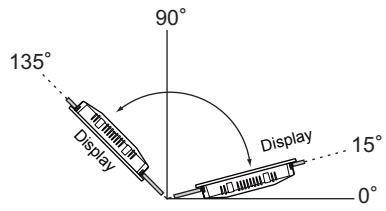

2. Power Supply Cable Connection



DANGER

Electric shock hazard
Shut the power off before connecting the power supply cable.

Power Supply Cable Connection

Connect the power supply cable to the terminal on the backside of the unit.

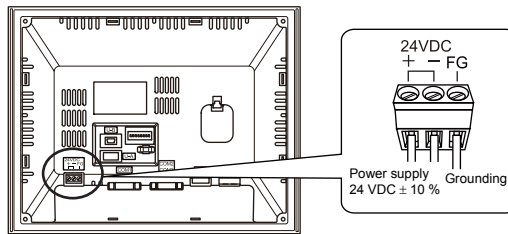

Cable Specifications

For information on the tightening torque of the screws on the terminal block, refer to the following table.

Tightening Torque	0.5 to 0.6 N•m (5 to 6 kgf•cm)
Recommended Screwdriver	SZS 0.6 × 3.5 (Phoenix Contact)

When Using Bare Cables



CAUTION

- Do not solder the end sections of power cable wires. Soldering may result in bad electrical contacts.
- When using stranded wire for the power cable, make sure the strands are sufficiently twisted.
Failure to do so may cause shorting between stray strands or adjacent electrodes.

Cable Size	Power supply cable: AWG 18 to AWG 14, twisted/single (1.0 to 1.6 mm diameter) Frame ground (FG): AWG 20 to AWG 14, twisted/single (0.8 to 1.6 mm diameter)
Wire Length	6.5 mm

When Using Ferrules

Recommended Ferrule (Pin type)*	Phoenix Contact	Al 0.75-6 GY
		Al 1-6 RD
		Al 1.5-6 BK
Recommended Crimping Tool	Phoenix Contact	CRIMPFOX 6

* Select a ferrule according to the cross section area (diameter) of the power cable.

Power Supply Cable Connection



DANGER

Avoid applying excessive force to the power supply cable. This may lead to unintentional disconnection of the cable and cause serious accidents such as electric shock.

- The power source must be within the allowable voltage fluctuation.
- Use a power source with low noise between the cables or between the ground and the cable.
- Use the thickest power supply cable possible to minimize drops in voltage, and twist.
- Keep power supply cables away from high-voltage, large-current carrying cables.

Grounding



CAUTION

Be sure to establish a ground of the TS Series.
(The level of grounding resistance should be less than 100 Ω .)

- An independent earth pole must be used for the TS Series.
- Use AWG20 to AWG14 size wiring for the grounding cable.
- Set the grounding point near the TS Series to shorten the distance of grounding cables.

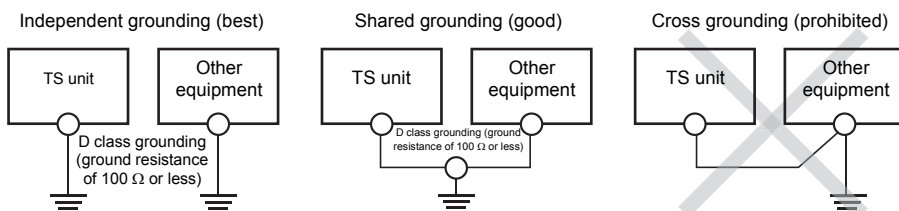

4 Handling of TS Series Components

1. Coin-type Lithium Battery
2. DIP Switches

1. Coin-type Lithium Battery

CAUTION The battery is inserted upon delivery.

Battery Usage

This battery for memory backup is used for the user memory area in SRAM (non-volatile memory \$L and \$LD, sampling data) and the built-in clock.

Time for Battery Replacement

The battery validity period is about three years after the date of manufacture.

When the time to replace the battery is approaching, the [Press this switch after battery replacement.] switch and the message "Battery changeover required" appear at the bottom of the Main Menu screen on the TS unit.

* For more information about the Main Menu screen, refer to "Main Menu Screen" (page 5-3).

Main Menu screen

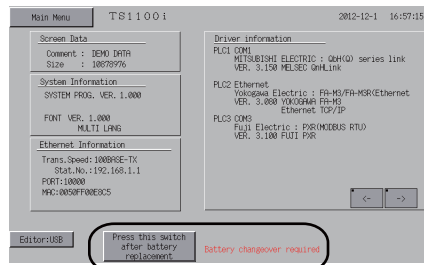

Battery Replacement

Recommended Battery

Recommended battery manufacturers and battery model are as follows:

Recommended Manufacturer	Model	
Mitsubishi Electric Home Appliance	CR2032	Coin-type lithium primary cell
Hitachi Maxell		
Panasonic		
FDK		

Safety Instructions on Handling the Battery

Lithium batteries contain combustible material such as lithium or organic solvents. Mishandling may cause heat, explosion or ignition resulting in fire or injury. To prevent accidents, pay attention to the following cautions when handling lithium batteries.



CAUTION

- Be sure to discharge static electricity from your body before battery replacement.
- Use the recommended battery for replacement.
- Rough handling of the battery may cause fire or chemical burn hazard.
- Do not disassemble, incinerate or heat the battery.
- Observe local and governmental regulations when disposing of waste batteries.
- Keep batteries out of reach of children. (If swallowed, immediately consult a doctor.)
- Never re-charge the battery.
- If the battery leaks or smells, the leaking battery electrolyte is flammable. Keep from heat or flame.

SRAM Area Backup Procedure

Before replacing the battery, be sure to make a backup copy of data stored in SRAM using the V-SFT-5 editor.

When Using the V-SFT-5 Editor:

- 1) Connecting a USB cable
Connect the TS unit and the computer with a USB cable.
 - 2) Starting the V-SFT-5 editor
Start the V-SFT-5 editor on the computer.
 - 3) Displaying the [Transfer] dialog
Click the [Transfer] icon. The [Transfer] dialog is displayed.
 - 4) Selecting data to be transferred
Select [Transfer Device: Display] and [Transfer Data: SRAM Data].
Do not check [Use Simulator].
 - 5) Starting SRAM data transfer
Click the [PC <-] button under [Transfer]. Data transfer from the SRAM is started.
 - 6) Saving the SRAM data
When the SRAM data has been transferred, the [Save As] dialog is displayed on the computer. Save the data as a backup copy. The extension is "*.RAM".
- * To transfer the "*.RAM" data saved as a backup to the TS unit, click the [PC ->] button under [Transfer] in step 5.

When Using Storage:

For backing up data to storage such as a USB memory, refer to "Saving Backup Copies of SRAM" (page 5-24).

Battery Replacement Procedure



Electric shock hazard

Turn off the power to the TS series before performing steps 3 through 7 below.

1. Make a backup copy of data stored in the SRAM area.
For backing up procedure, refer to "SRAM Area Backup Procedure" (page 4-2).
2. Turn off the TS unit.
3. Lift and remove the cover of the battery holder according to the arrows marked in the figures below.

Example: TS1070

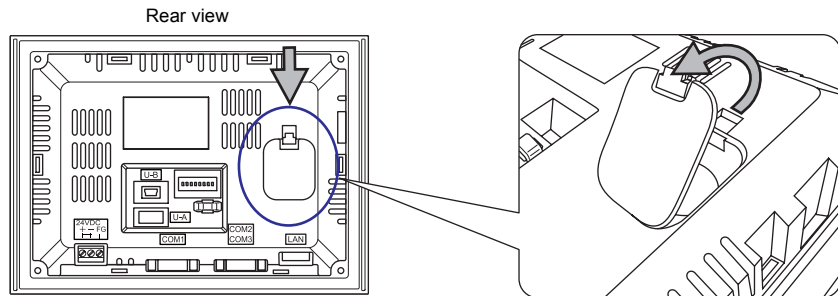

4. Press the detent on the right of the battery in the direction of the arrow.

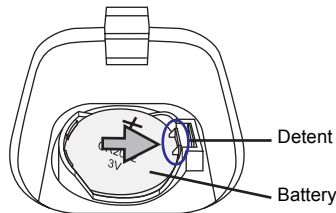

5. When the right side of the battery rises, insert a finger under the battery as indicated by the arrow and take it out.

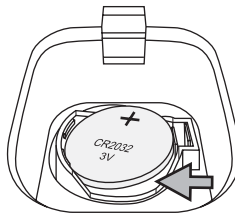

6. Slide a new battery with the "+" side of facing upward, to the left into the battery holder. Press the right side of the battery until it clicks.

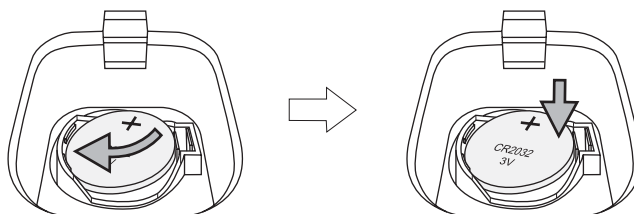

7. Insert the detent on the underside of the battery holder cover into the TS unit. Press the top of the cover until it clicks.

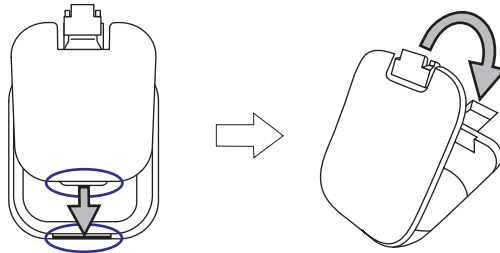

8. Turn on the TS unit. Go to the Main Menu screen and press the [Press this switch after battery replacement.] switch.

The following confirmation dialog appears. Press [Completed].

* If not replacing with a new battery, press [Cancel].



If the [Completed] switch is pressed though no new battery is set, no power will be supplied to retain the clock time and SRAM.
Finish replacing with a new battery before pressing [Completed].

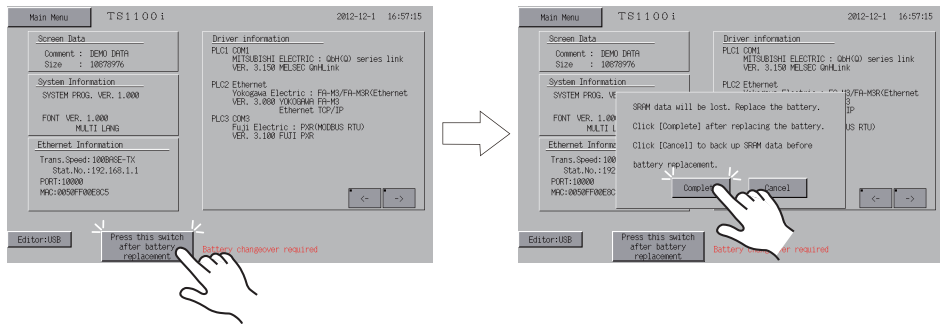

9. Check that the [Press this switch after battery replacement.] switch and the message "Battery changeover required" are cleared from the bottom of the Main Menu screen.

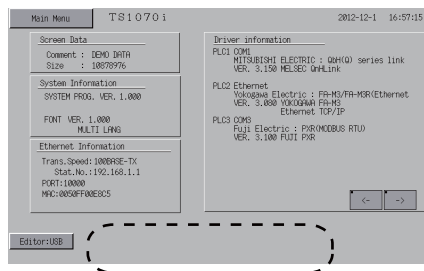

10. When a backup file "*_RAM" is saved, transfer it to the TS series.

Notes on Battery: EU Directive 2006/66/EC

According to the EU directive 2006/66/EC effective in EU countries, the battery supplied with the TS series as well as the package box of the TS series have the marking shown below:



CAUTION

- The marking shown above is effective only in EU countries.
- The details on the marking are designated in Article 20 "Information for end-users" and ANNEX II in EU directive 2006/66/EC.
- The marking indicates that the battery should be disposed of separately from general household waste.
- If element symbols are indicated below the marking, it means that the battery contains the specified heavy metal at a concentration exceeding the control value. See the following for the control values of concentration.
Hg: mercury (0.0005 %), Cd: cadmium (0.002 %), Pb: lead (0.004 %)
- The EU has determined the separating program for used batteries.
Dispose of used batteries properly at your local waste-disposal/recycling center.

2. DIP Switches

DIP Switch (DIPSW) Setting

The TS series is equipped with DIP switches 1 to 8. When setting the DIP switches, turn the power off. Upon delivery, all the DIP switches are set to OFF.

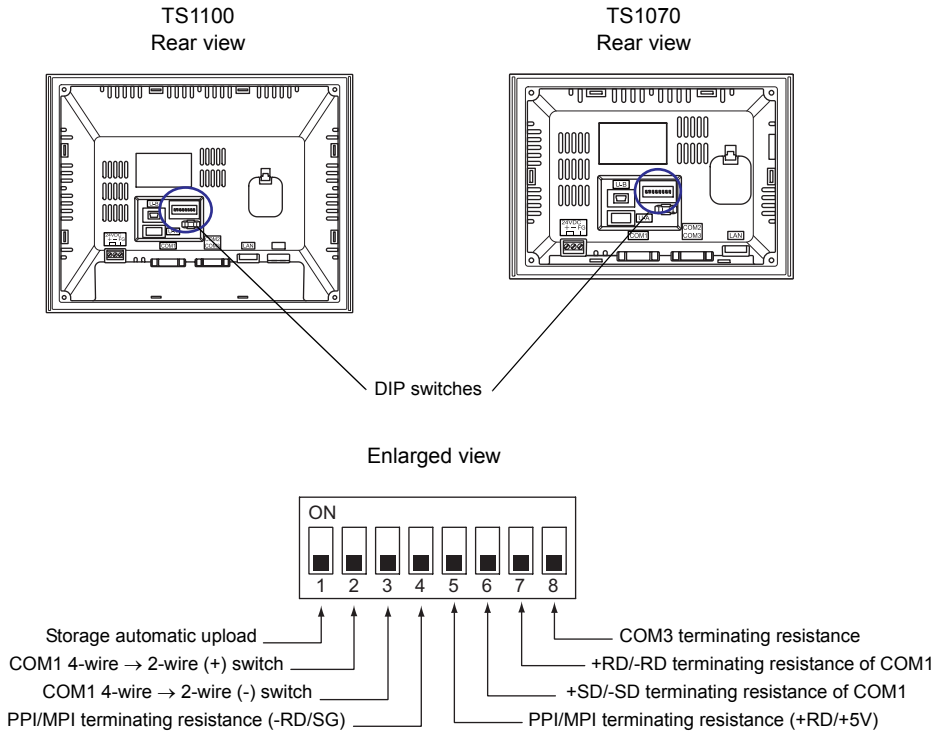

DIPSW1* (Storage automatic upload)

Set the DIPSW1 to ON when automatically uploading screen data from storage such as a USB memory.

Procedure

1. Preparation of storage
Prepare storage such as a USB memory with screen data written from V-SFT-5. (For the loading procedure, refer to the V8 Series Reference Manual.)
2. Connection of storage
Turn off the TS unit. Connect the storage device to the USB-A port.
3. DIP switch setting
Slide the DIPSW1 to ON.
4. Automatic upload start
Turn on the TS unit. Screen data is automatically loaded into the flash memory of the TS unit.

* Be sure to set the DIPSW1 to OFF when automatic upload is not performed.

DIPSW2 and DIPSW3 (COM1 switching between 4-wire and 2-wire)

- When connecting a controller to COM1 via RS-422/485 (2-wire connection), set the DIPSW2 and DIPSW3 to ON.
- When connecting a controller to COM1 via RS-422/485 (4-wire connection), set the DIPSW2 and DIPSW3 to OFF.

DIPSW4 and DIPSW5 (PPI/MPI terminating resistance setting)

When connecting a Siemens PLC (PPI/MPI) to COM1, set the DIPSW4 and DIPSW5 to ON.

DIPSW6, DIPSW7, and DIPSW8 (terminating resistance setting)

- When connecting a controller to COM1 via RS-422/485 (2-wire connection), set the DIPSW7 to ON.
- When connecting a controller to COM1 via RS-422/485 (4-wire connection), set the DIPSW6 and DIPSW7 to ON.
- When connecting a controller to COM3 via RS-422/485 (2-wire connection), set the DIPSW8 to ON.

MEMO

Please use this page freely.

5 TS Series Operations

1. Before Operation
2. Main Menu Screen
3. System Menu

1. Before Operation

Procedure before Operation

1. Mount the TS series on the mounting panel, install it and carry out wiring.
For more information, refer to “Chapter 3”.
2. Install peripheral devices, such as PLCs or temperature controllers, and carry out wiring.
For information on precautions, refer to the TS series Connection Manual separately provided.
3. Turn the TS series on.

When turning the power on for the first time:



Other cases:

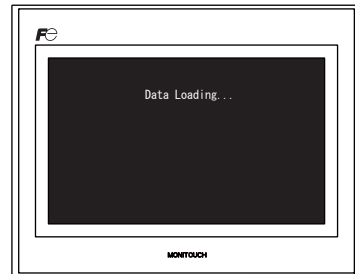

4. Transfer the created screen data.
 - When transferring screen data for the first time:
For details, refer to “Transferring Screen Data to TS Series for the First Time” (page 5-2).
 - Other cases:
For information on the procedure to change screen data with another, refer to the V8 series Operation Manual.
5. Start MONITOUCH operation. To change to the RUN mode, refer to “Main Menu Screen” (page 5-3).

When the connection with controllers has been established, the RUN screen is displayed.

- * If MONITOUCH does not operate normally and shows an error message, eliminate the cause by referring to Chapter 6 or the V8 Series Reference Manual.

Transferring Screen Data to TS Series for the First Time

There are four methods for transferring screen data for the first time after purchase.

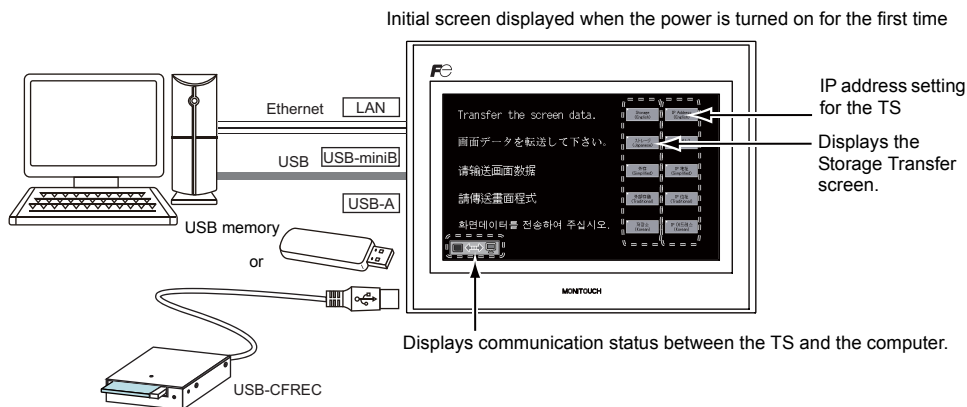

- 1) Transfer via USB
Connect a USB cable to the USB slave port (USB-miniB) on the TS series, and transfer screen data from the computer.
- 2) Transfer from storage
Use a USB memory device or an optional USB-CFREC with a CF card.
Load screen data from the computer into storage in advance.
Press the [Storage (English)] switch on the initial screen. The Storage Transfer screen is displayed. Data transfer can be performed on the screen.

Storage (English)

IP Address (English)
- 3) Transfer from storage (automatic upload)
Load screen data from the computer to the storage device (e.g. USB memory) in advance.
When the power to MONITOUCH is turned on, screen data transfer is automatically started.
- 4) Transfer via Ethernet (TS1100i/TS1070i only)
Connect an Ethernet cable to the LAN port on the TS series, and transfer screen data from the computer.
Pressing the [IP Address (English)] switch on the initial screen brings up the Ethernet screen. Set the IP address for the TS series on the screen.

Storage (English)

IP Address (English)

When the screen data has been transferred, the following screen is brought up. For details, refer to “Main Menu Screen” (page 5-3).

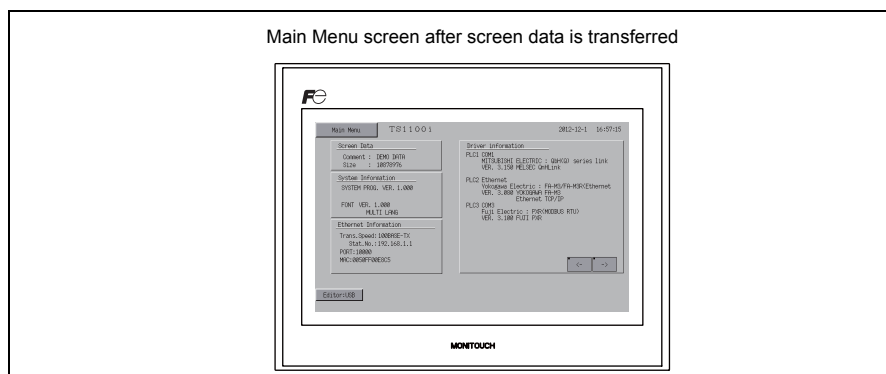

2. Main Menu Screen

Displaying the Main Menu Screen

To bring up the Main Menu screen in the RUN mode, press the corners on the TS series unit and the [MODE] switch on the System Menu*.

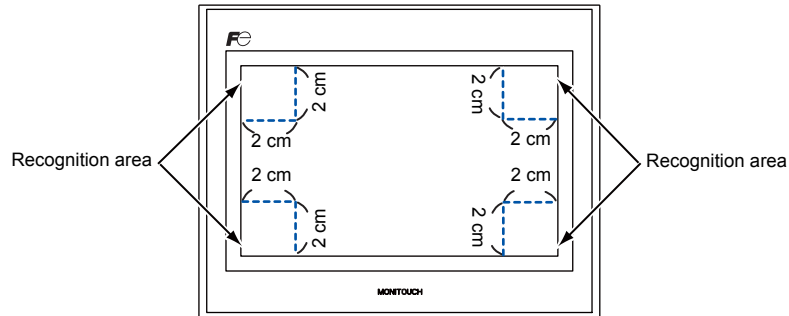

* For the details on the System Menu, refer to "System Menu" (page 5-43).

1. Hold down any corner for two seconds or longer, and remove your finger.

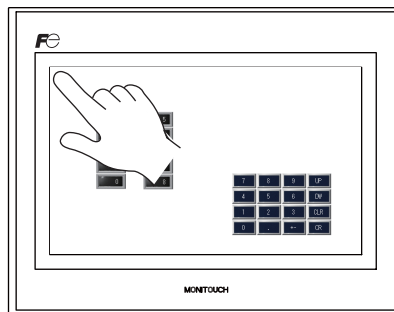

Hold down the upper left corner for two second or longer.

2. Hold down one of the other three corners for two seconds or longer. Then the System Menu is displayed.

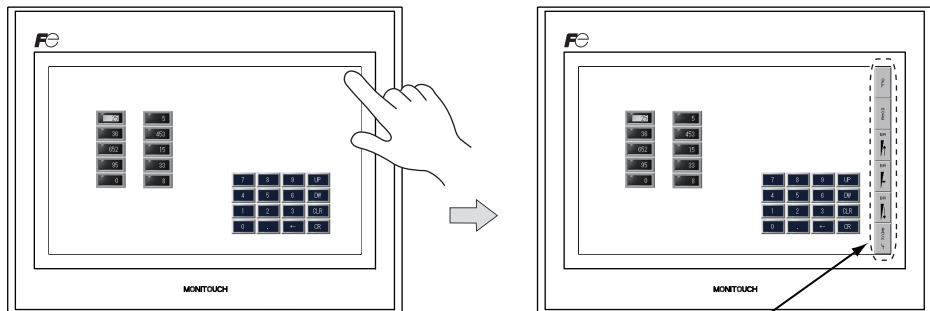

Hold down one of the other three corners for two second or longer.

System Menu

* When an item, such as a switch, data display part with switch, display area, slider switch, scroll bar, or table data display part, is placed on the position you press, the switch in the recognition area becomes invalid. Press a corner where none of the items described above is placed. If the items are placed on all of the corners, change the screen to another and display the Main Menu screen by following the procedure described above.

- Press the [MODE] switch while the System Menu is displayed. Then the Main Menu screen is displayed.

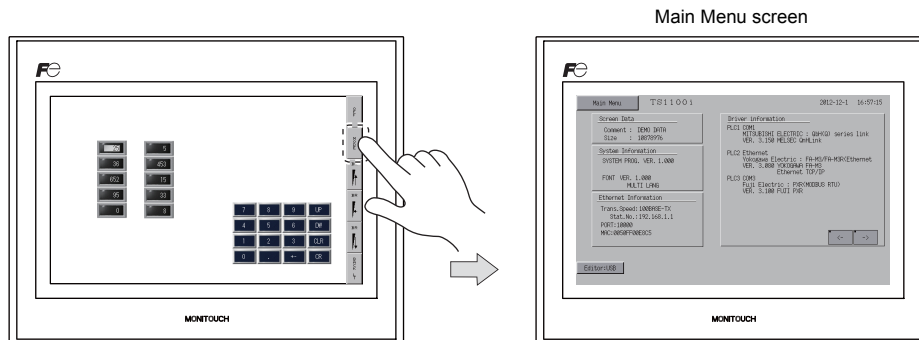

Main Menu Screen

The Main Menu screen indicates the TS series model, system information, and screen data information.

Also, it works as the system screen when the screen data is transferred between a computer and the TS series.

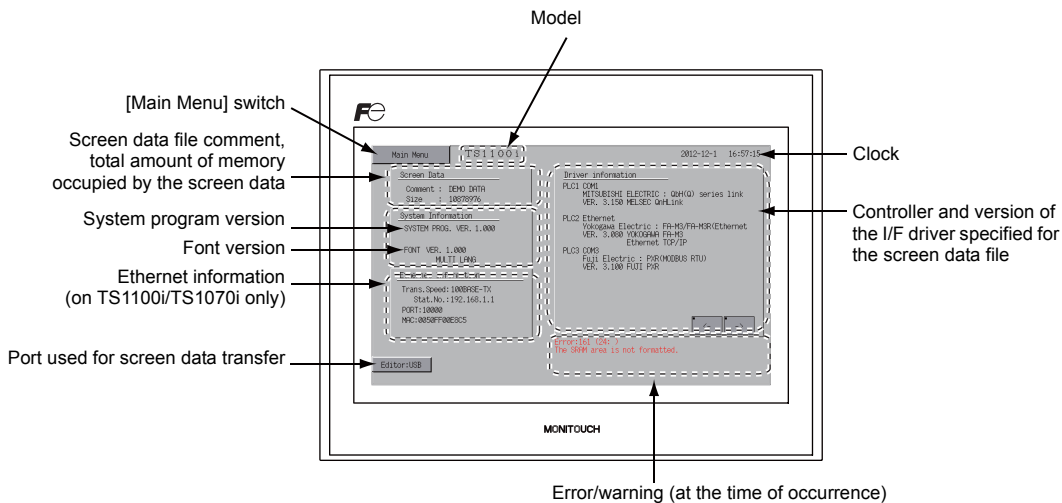

[Main Menu] Switch

Pressing the [Main Menu] switch brings up the following drop-down window.

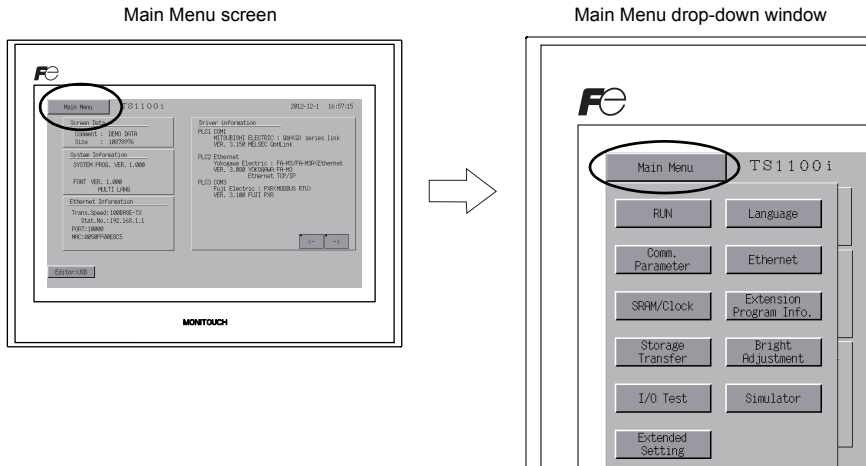

Main Menu Screen Composition

The Main Menu screen is configured as shown below:

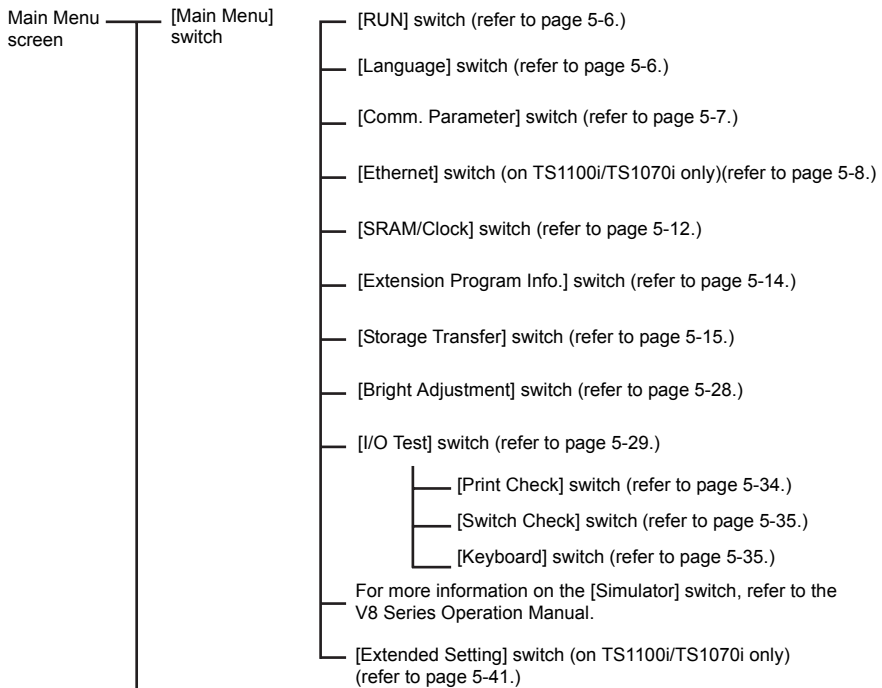

Hold down the [Editor : USB] switch at the bottom left corner of the Main Menu screen for three seconds or longer.
For more information, refer to "Extended Function Setting" (page 5-41).

1. RUN

Pressing the [RUN] switch on the Main Menu drop-down window switches the screen to the RUN mode.

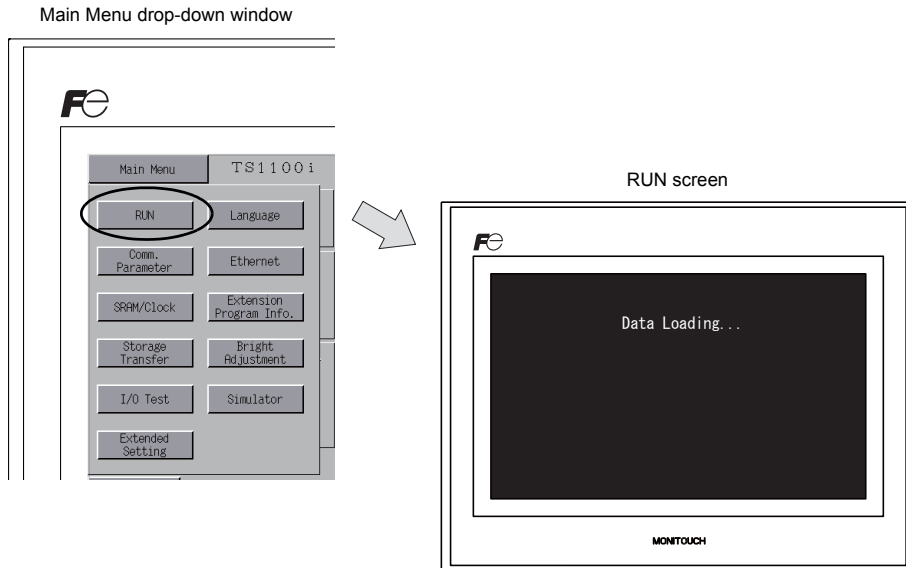

2. Language Selection

Pressing the [Language] switch on the Main Menu drop-down window brings up the Language Selection screen.

Languages* selected in the [Font Setting] dialog of the V-SFT-5 editor are displayed on the Language Selection screen that is used for selecting an interface language for the Main Menu screen.

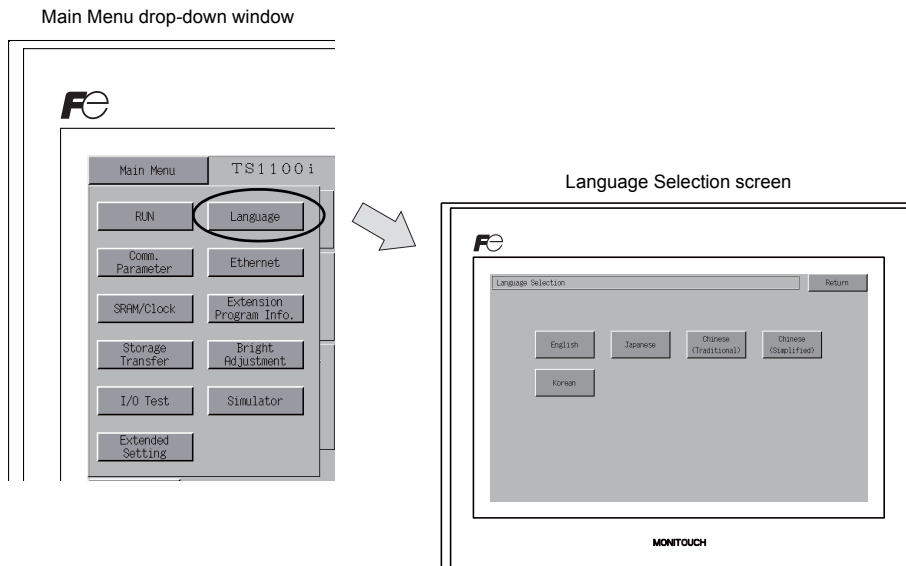

* The interface language for the Main Menu screen can be selected from English, Japanese, Chinese (Simplified), Chinese (Traditional) or Korean. English is always displayed.

3. Communication Parameter

Pressing the [Comm. Parameter] switch on the Main Menu drop-down window brings up the Comm. Param. screen.

Communication parameters of PLC1 to PLC8 that are set on the V-SFT-5 editor can be checked on this screen.

Main Menu drop-down window

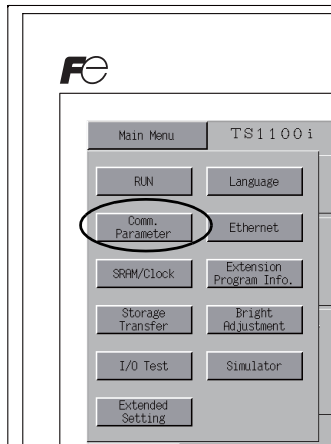

Comm. Param. screen

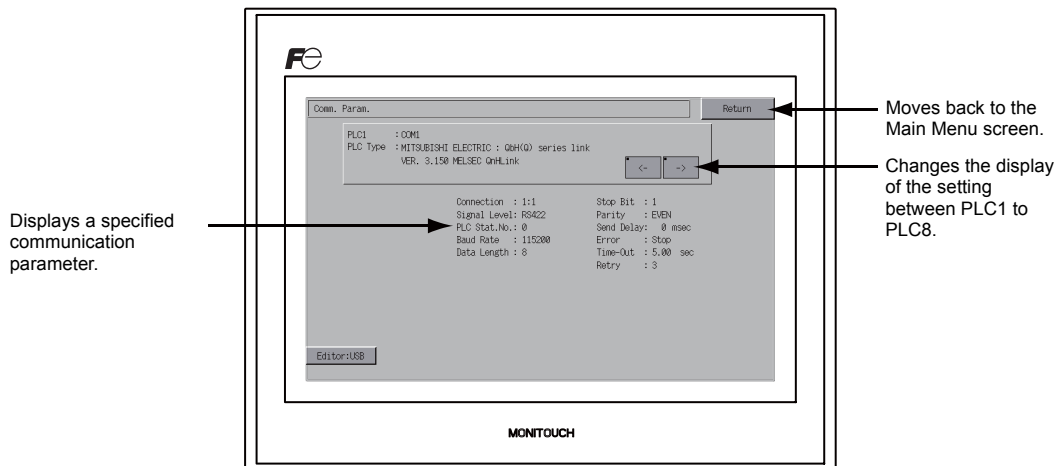

4. Ethernet (TS1100i/TS1070i Only)

Pressing the [Ethernet] switch on the Main Menu drop-down window brings up the Ethernet screen. This screen is used to set an IP address for the TS unit.

Main Menu drop-down window

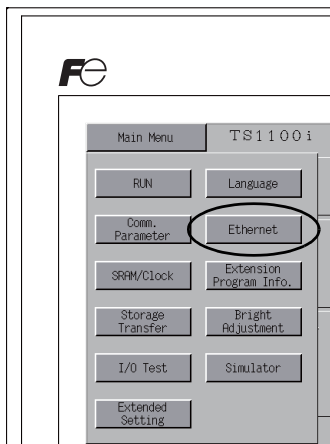

Ethernet screen

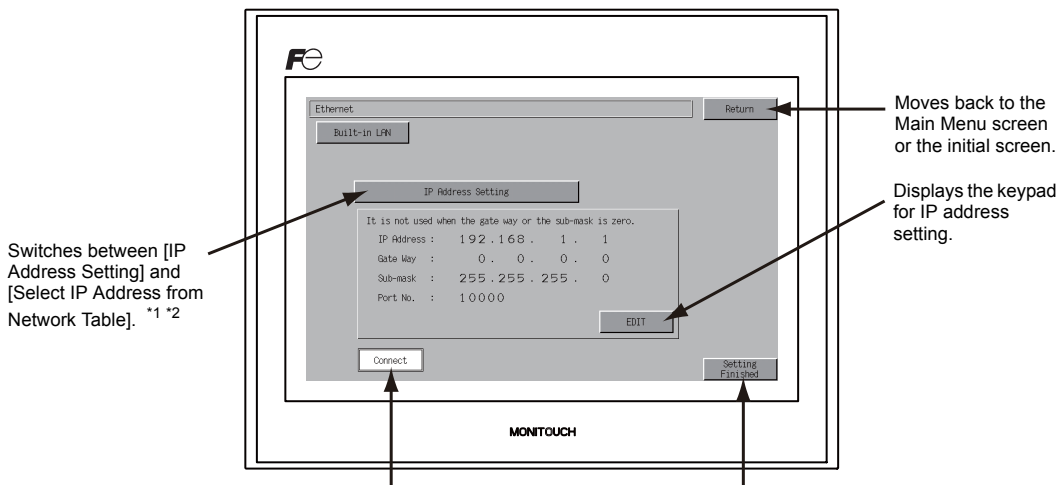

Indicates whether the LAN port works correctly with an Ethernet cable inserted.

Normal: Connect (white)
Abnormal: Disconnect (gray)

When making the setting, press the [Setting Finished] switch to determine the setting. The Main Menu screen is displayed.

*1 For more information, refer to the TS Series Connection Manual.

*2 This switch is not displayed if [IP Address Setting] (page 5-10) is set using V-SFT editor.

4-1. IP Address Setting for the TS Series

For communicating via Ethernet, set the IP address for the TS unit. An IP address can be set either on the TS unit or in screen data using the V-SFT editor.

Setting on the TS Unit

1. Press the [Ethernet] switch on the Main Menu drop-down window to display the Ethernet screen.
2. Press the [EDIT] switch and set each item.

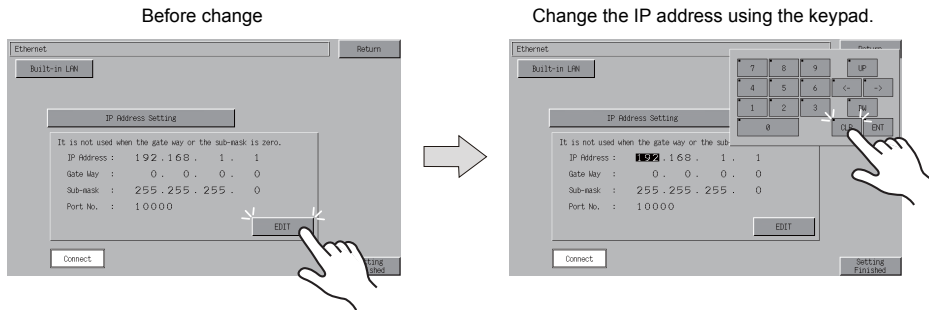

3. Press the [Setting Finished] switch to determine the IP address. Check the IP address displayed under [Ethernet Information] on the Main Menu screen.

Determine the IP address setting.

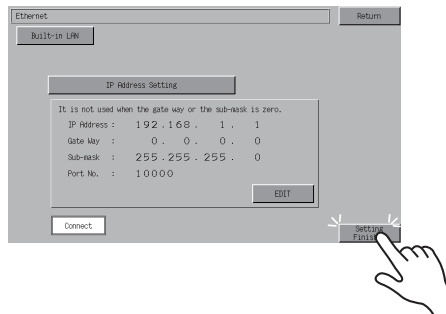

Setting using the V-SFT Editor

1. Select [System Setting] → [Ethernet Communication] → [Local Port IP Address] on the V-SFT editor. The [IP Address Setting] dialog is displayed.
2. Check the [Set IP] check box and set each item.

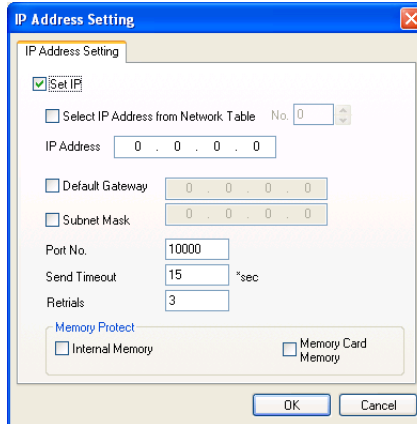

<input type="checkbox"/> Select IP Address from Network Table	This is valid when the IP address of the TS has been registered in the network table. Select a network table number from 0 to 99 to set the IP address.
IP Address *	Set the IP address for the TS.
<input type="checkbox"/> Default Gateway *	Set the default gateway.
<input type="checkbox"/> Subnet Mask *	Set the subnet mask. When this box is not checked, the subnet mask is automatically assigned based on the byte at the extreme left of the IP address. Example: IP address 172.16.200.185: "255.255.0.0" is set. IP address 192.168.1.185: "255.255.255.0" is set.
<input type="checkbox"/> Port No. *	Set a port No. 1024 to 65535, except for 8001.
Send Timeout	Set a timeout period for transmitting macro commands SEND, EREAD or EWRITE, or macro commands for MES.
Retrials	0 to 255 Set the number of retrials to be performed when a time-out occurs.
Memory Protect <input type="checkbox"/> Internal Memory <input type="checkbox"/> Memory Card Memory	Check either check box to write-protect the memory from computers or other stations.

* For more information on setting items, refer to page 5-11.

3. Click [OK].
4. Transfer the screen data to the TS unit. Check the IP address displayed under [Ethernet Information] on the Main Menu screen.

IP Address

This is an address that is used for recognizing each node on the Ethernet and should be unique. The IP address is 32-bit data which consists of the network address and the host address and can be classified into A to C depending on the network size.

Class A	0	Network address (7)	Host address (24)
Class B	10	Network address (14)	Host address (16)
Class C	110	Network address (14)	Host address (8)

Notation
 A string of 32-bit data is divided into four, and each segment delimited with a period is in decimal notation.
 Example: The IP address in class C shown below is represented as "192.128.1.50".
 11000000 10000000 00000001 00110010

<Unusable IP addresses>

- "0" is specified for one byte at the extreme left. Example: 0.x.x.x
- "127" is specified for one byte at the extreme left (loop back address). Example: 127.x.x.x
- "224" or more is specified for one byte at the extreme left (for multi-cast or experiment). Example: 224.x.x.x
- The host address consists of only "0" or "255" (broadcast address). Example: 128.0.255.255, 192.168.1.0

Port Number

Multiple applications are running on each node, and communications are carried out for each application between the nodes. Consequently, it is necessary to have a means to identify the application that data should be transferred to. The port number works as this identifier. Each port number is 16-bit data (from 0 to 65535). The TS series uses ports for screen data transfer (8001), PLC communication (as desired), and the simulator (8020). Set a unique number in the range of 1024 to 65535. For a PLC or a computer, set the port number in the range of 256 to 65535. It is recommended to set a greater number.

Default Gateway

A gateway and a router are used for communication between different networks. The IP address of the gateway (router) should be set to communicate with the node(s) on other networks.

Subnet Mask

A subnet mask is used for dividing one network address into multiple networks (subnet). The subnet is assigned by specifying a part of the host address in the IP address as a subnet address.

Class B	10	Network address (14)	Host address (16)
Subnet mask		255. 255.	255. 0
	11111111	11111111	11111111 00000000
	Network address	Subnet address	Host address

<Unusable subnet masks>

- All bits are set to "0". 0.0.0.0
- All bits are set to "1". 255.255.255.255

5. SRAM/Clock

Pressing the [SRAM/Clock] switch on the Main Menu drop-down window brings up the SRAM/Clock screen.

This screen is used for correcting the built-in calendar (date and time) and for formatting the SRAM area.

Main Menu drop-down window

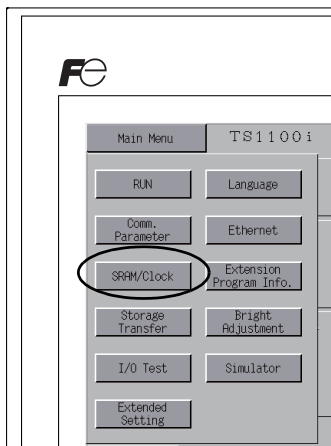

SRAM/Clock screen

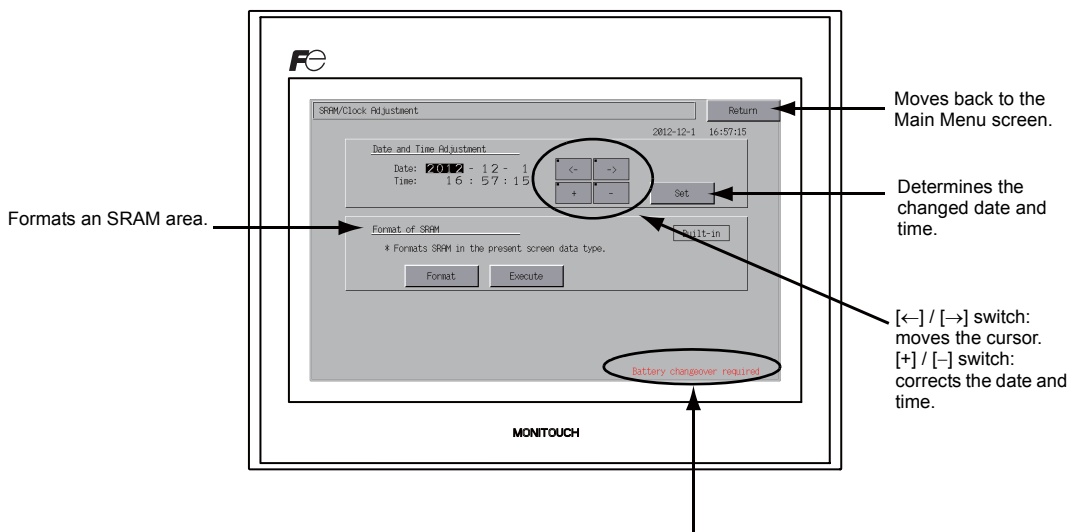

Displayed when the time for battery replacement is approaching. *1

*1 Be sure to replace the battery. SRAM and clock time cannot be retained without battery power. For replacing the battery, refer to "Coin-type Lithium Battery" (page 4-1).

5-1. Date and Time Adjustment

This screen is used for correcting the built-in clock of the TS series.

To use the built-in clock of the TS series, check [Use Built-in Clock] in the [SRAM/Clock Setting] dialog that is displayed by selecting [System Setting] → [Unit Setting] → [SRAM/Clock] on the V-SFT-5 editor.

1. Move the cursor using the [←] and [→] switches. Correct the date and time using the [+] and [-] switches.
2. Press the [Set] switch to determine the setting. The clock displayed on the upper right is modified.

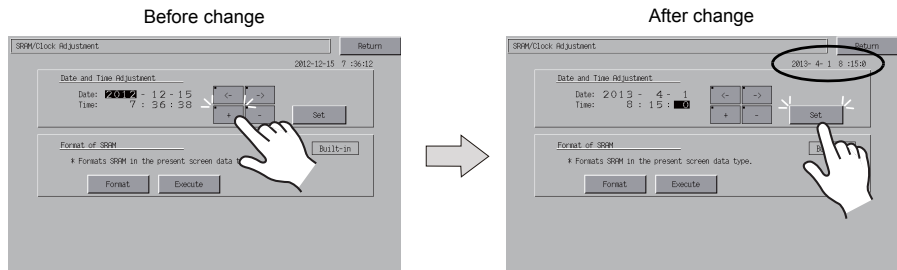

3. Pressing the [Return] switch displays the Main Menu screen again.

5-2. Formatting SRAM

An SRAM area can be formatted.

When the SRAM area is formatted, the contained data (historical data saved in SRAM, internal memory \$L, etc.) is cleared. Double-check before formatting the SRAM.

1. Press the [Format] switch and the [Execute] switch.
The SRAM area is formatted in the current screen data format. When formatting has been completed, the message "**Format Completed**" is displayed.

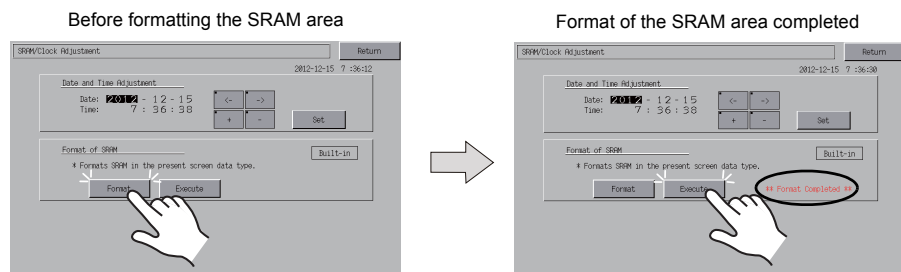

2. Pressing the [Return] switch displays the Main Menu screen again.

6. Extension Program Information

Pressing the [Extension Program Info.] switch on the Main Menu drop-down window brings up the Extension Program Info. screen. This screen is used for checking program versions of the ladder transfer function, simulator, etc.

Main Menu drop-down window

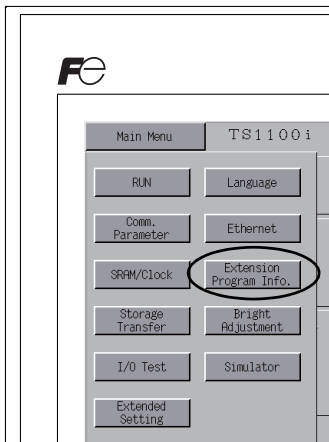

Extension Program Info. screen

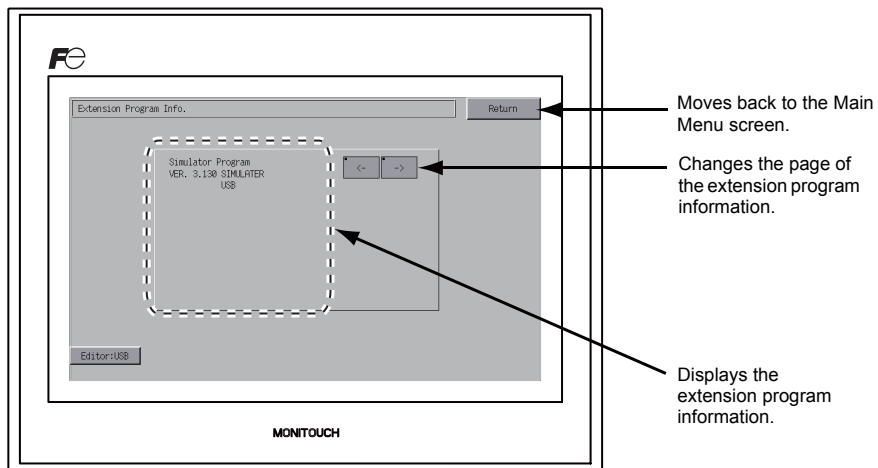

7. Storage Transfer

Pressing the [Storage Transfer] switch on the Main Menu drop-down window brings up the Storage Transfer screen.

This screen is used to transfer screen data between the TS series and a USB memory device or a CF card (with an optional USB-CFREC).

Main Menu drop-down window

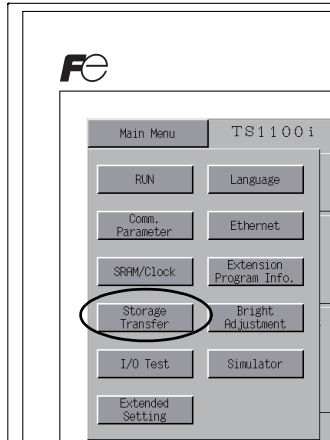

Storage Transfer screen

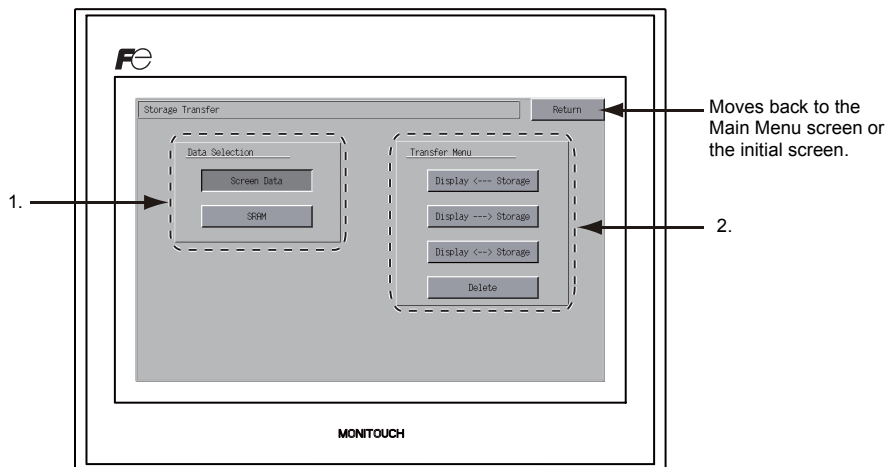

1. [Data Selection] field

- [Screen Data]
Press this switch when transferring screen data to/from storage.
- [SRAM]
Press this switch when backing up data from the SRAM in the TS series to a storage device before battery replacement or when uploading from a storage device to the SRAM.

2. [Transfer Menu] field
 - [Display <--- Storage]
Press this switch when transferring data from a storage device to the TS series.
 - [Display---> Storage]
Press this switch when transferring data from the TS series to a storage device.
 - [Display <--> Storage]
Press this switch when comparing stored data between the TS series and a storage device.
 - [Delete]
Press this switch when deleting data from storage.

7-1. Storage Folder Configuration

The table below lists the folders in storage, the files in the folders, and the contained data. For more information, refer to the V8 Series Reference Manual.

Storage (USB memory/CF card)

 DAT0000 (Access folder name: User-definable within 32 one-byte characters)

Folder Name (fixed)	Contents	File Name	Transfer Direction
BITMAP	Pattern (bitmap) data	BMPxxxx.BIN	TS ← Storage
CARD	Recipe data using the V6-compatible memory manager function	MCMHEAD.BIN MCMxxxx.BIN	TS ↔ Storage
DSP	Screen data	DSP0000.BIN	TS ↔ Storage
FONT	Gothic fonts or language data	xxxxxx.FTD	TS ← Storage
HDCOPY	Hard copy image (JPEG/BIN format selectable for 128-color display) *1	HDxxxx.JPG HDxxxx.BIN	TS → Storage *4
JPEG	JPEG file (except for some models)	xxxxx.JPG JPxxxxx.JPG	TS ← Storage
LADDER	Ladder data associated with the ladder monitor function *2		TS ← Storage
MEMO	Memo pad data	MEMxxxx.BIN	TS → Storage *5
MSG	Message file	MSGxxxxy.BIN MSGxxxxy.TXT	TS ← Storage
OPELOG	Operation log file *3	OPELOG_hhmmss.BIN	TS ↔ Storage
RECIPE	Recipe data *1	RECxxxx.CSV xxxxxxx.CSV	TS ↔ Storage
SAMPLE	Data of data logging and alarm history	SMPxxxx.BIN SMPxxxx.CSV	TS → Storage *5
	Title file	SMHxxxx.CSV	TS ← Storage
SCRN	Header file	SCHEADER.BIN	TS ← Storage
	Screen file Component parts (macro blocks, sampling messages)	SCxxxx.BIN MCRxxxx.BIN MSGxxxx.BIN	
	3D parts file	3Dxxxx.BIN	
	Windows font file (graphics, messages)	WFSxxxx.BIN WFMxxxx.BIN	
SRAM	Backup copy of SRAM	SRM0000.BIN	TS ↔ Storage
WEBSERV	Files to be accessed from the Web browser	*.SHT, *.HTML, *.TXT etc.	TS ← Storage

*1 Refer to the V Series Macro Reference.

*2 Refer to the V8 Series Ladder Monitor Specifications.

*3 Refer to the V8 Series Reference: Additional Functions.

*4 On the Web server: TS ← Storage

*5 Files created on the TS: TS ← Storage

Storage (USB memory/CF card)

 DSPDEF (Screen data automatic upload folder: Fixed folder name)

Folder Name (fixed)	Contents	File Name	Transfer Direction
DSP	When a storage device is inserted into the TS unit on condition that DIP switch settings on the unit are finished, screen data will automatically be uploaded into the unit.	DSPDEF.BIN	TS ← Storage

(Other folders are the same as the "access folder".)

7-2. Transferring Screen Data

This section describes how to transfer data to/from a USB memory device inserted in the TS series.

1. USB memory connection
Connect a USB memory device to the USB-A port.
2. Storage Transfer Screen display
Open the Main Menu drop-down window on the Main Menu screen. Press the [Storage Transfer] switch on the window.
The Storage Transfer screen is displayed.
* Do not remove and reinsert the USB memory device from now on.
3. USB memory data selection
Select [Screen Data] from the [Data Selection] field.

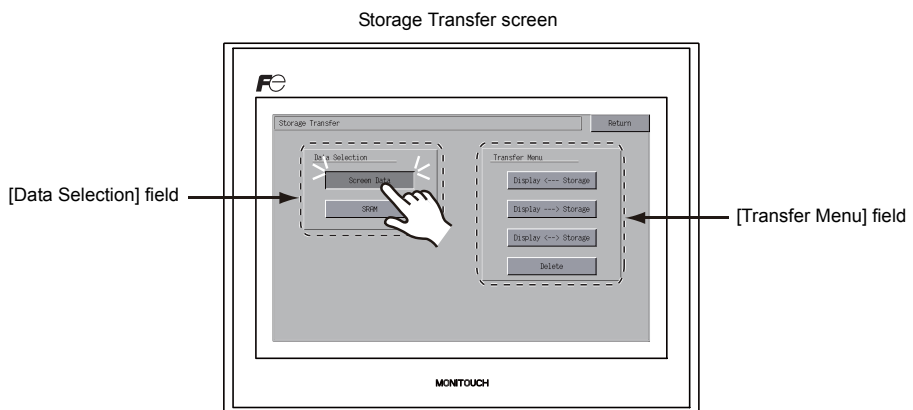

4. [Transfer Menu] field
 - Refer to “When [Display <--> Storage] Is Selected:” (page 5-19).
 - Refer to “When [Display <--> Storage] Is Selected:” (page 5-22).
 - Refer to “When [Display <--> Storage] Is Selected:” (page 5-23).

When [Display ← Storage] Is Selected:

1. When [Display ← Storage] is selected, the Storage Transfer screen below is displayed.

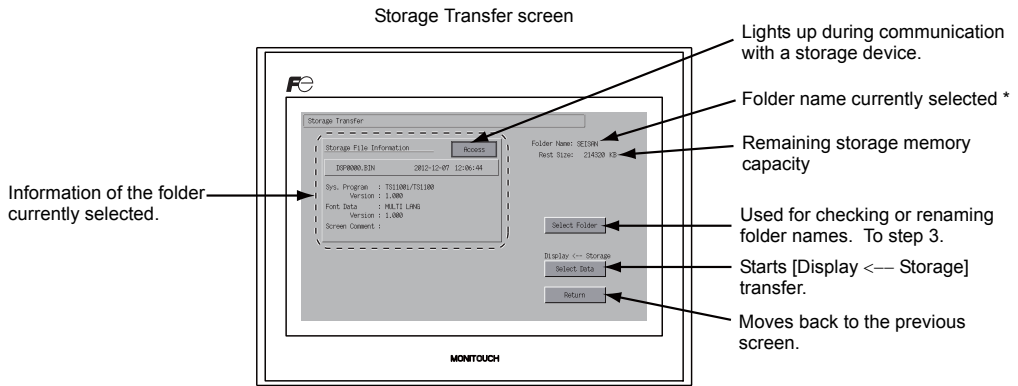

* The access folder name that is set for screen data is displayed as default. If there is no screen data in the TS series, "DAT0000" is displayed.

2. Access folder confirmation
Check [Folder Name], [Rest Size], and [Storage File Information]. When the selected folder is OK, go to step 4. To change the folder, go to step 3.
3. Access folder change (showing folders in storage)
When changing the access folder to another folder, press the [Select Folder] switch. The Select Folder screen is displayed. Select the desired folder and press the [OK] switch.

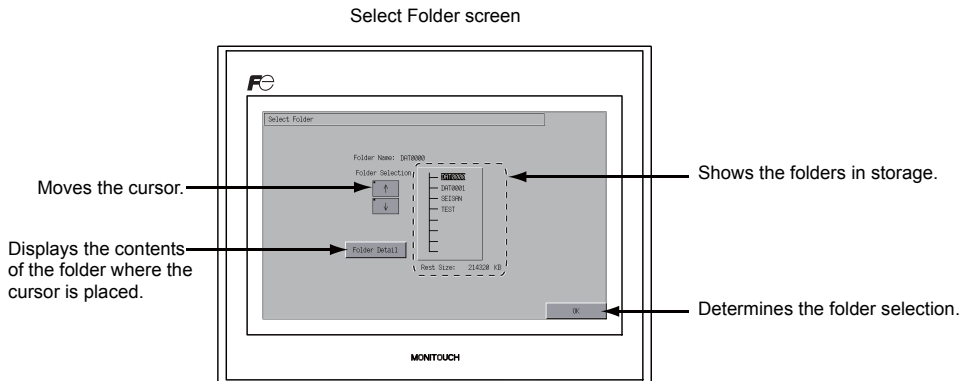

Pressing the [Folder Detail] switch displays the contents of the folder where the cursor is placed.

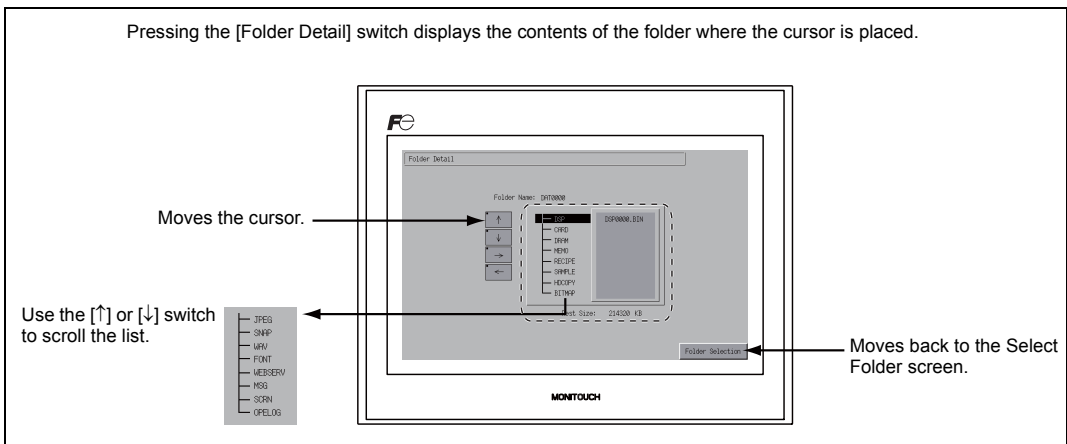

4. Transfer data selection

After selecting the folder, press the [Select Data] switch.

The [Data Selection] dialog is displayed, and the [Select Data] switch changes to [Start].

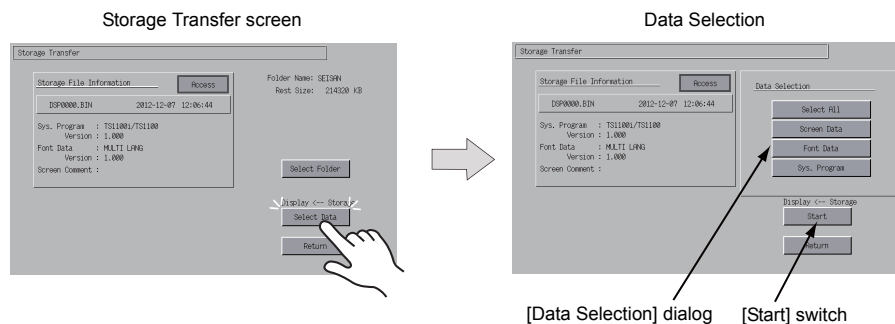

* To cancel the [Data Selection] dialog, press the [Return] switch.

5. Data transfer start

Select the desired data, and press the [Start] switch. The [Start] switch changes to [Transferring].

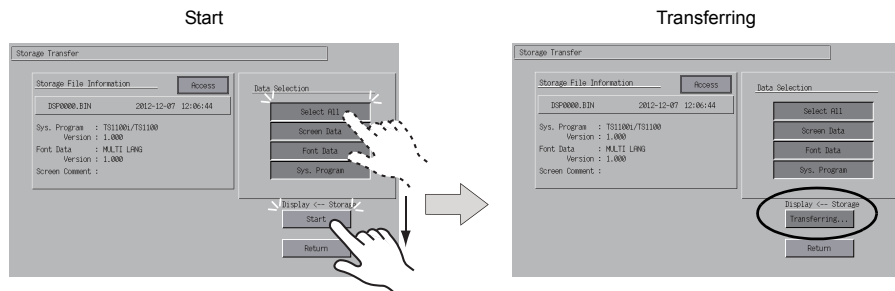

6. Data transfer completed
When the data has been transferred successfully, the following message dialog is displayed. Press the [OK] switch.
If the [Sys. Program] or [Select All] switch was selected on the [Data Selection] dialog, the Main Menu screen is automatically displayed on completion of data transfer.

Data transfer completed

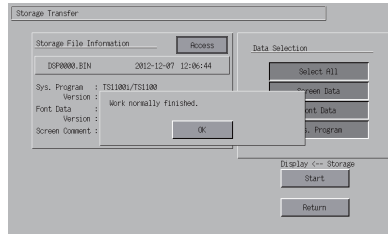

- * If any other message is displayed, refer to “Message Dialog Displayed during Data Transfer (between TS and Storage)” (page 5-27).

When [Display → Storage] Is Selected:

1. When [Display → Storage] is selected, the Storage Transfer screen below is displayed.

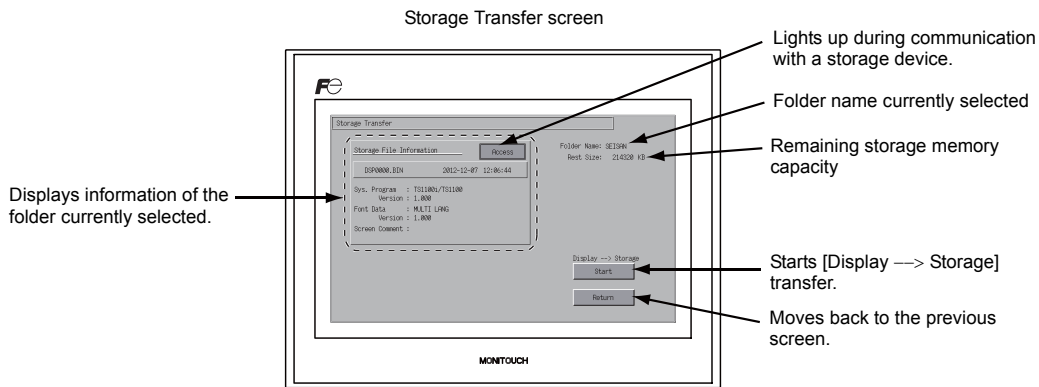

2. Data transfer start

Check [Folder Name] and [Storage File Information], and press the [Start] switch.

* If the access folders of the screen data and the storage device are given the same name, the folder in the storage device will be overwritten.
 If [Storage File Information] field is blank, a new file "DSP0000.BIN" will be created in the DSP folder under the access folder.

3. During data transfer to data transfer completed

During data transfer, the [Start] switch changes to [Transferring]. When data has been transferred successfully, the following message dialog is displayed. Press the [OK] switch.

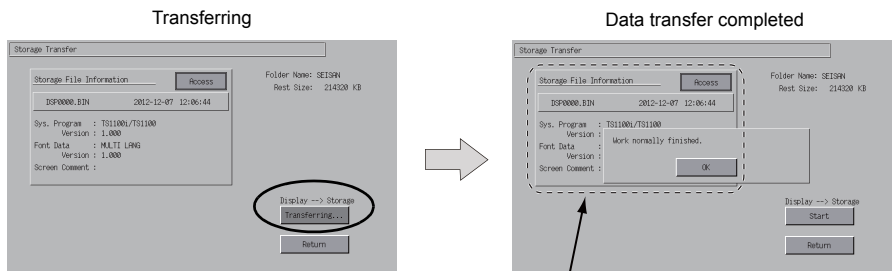

[Storage File Information] switches to the information on the transferred data.

* If any other message is displayed, refer to "Message Dialog Displayed during Data Transfer (between TS and Storage)" (page 5-27).

When [Display <=> Storage] Is Selected:

1. When [Display <=> Storage] is selected, the Storage Transfer screen below is displayed. The screen data in the unit is compared with the screen data (in the DSP folder) in the access folder.

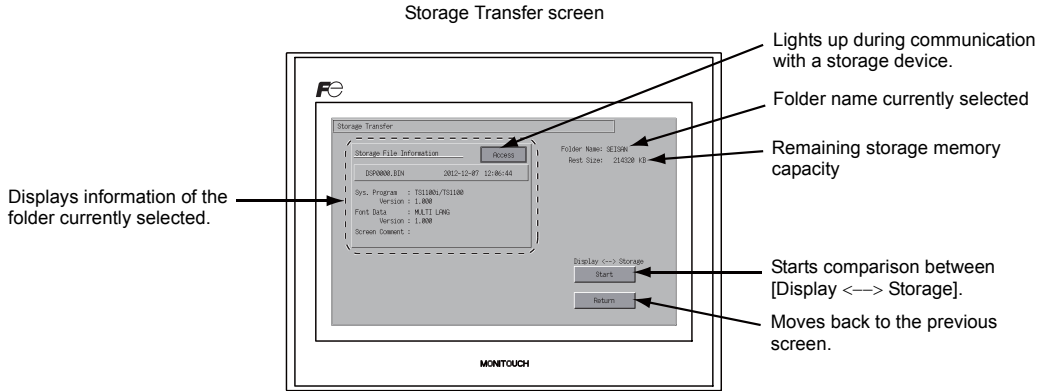

2. Data comparison start
Press the [Start] switch.
3. During data comparison to data comparison completed
During data comparison, the [Start] switch changes to [Transferring]. On successful completion, the following message dialog is displayed. Press the [OK] switch.

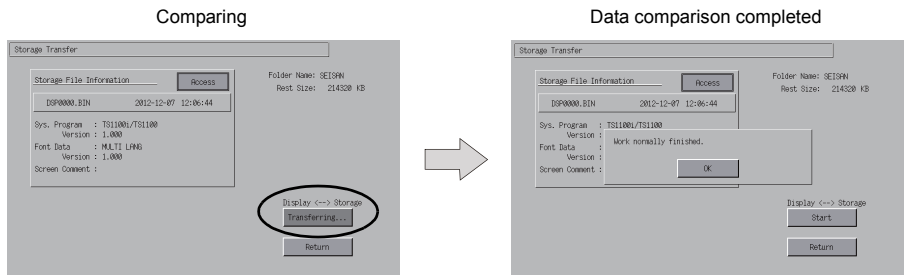

* If any other message is displayed, refer to “Message Dialog Displayed during Data Transfer (between TS and Storage)” (page 5-27).

7-3. Saving Backup Copies of SRAM

This section explains the procedure for saving backup copies of the SRAM memory for battery replacement.

1. Data selection
Press the [SRAM] switch on the Storage Transfer screen. When the switch is in the pressed state, it is selected.
2. Transfer operation selection
Select [Display <--- Storage], [Display ---> Storage] or [Display <--> Storage] from [Transfer Menu].

[Transfer Menu] field

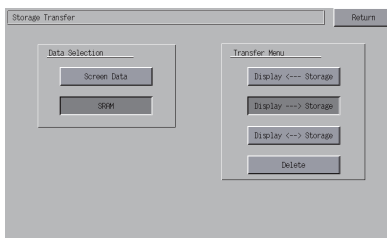

3. Access folder confirmation and selection
The SRAM Transfer screen is displayed.
 - When [Display ---> Storage] or [Display <--> Storage] is selected:
The access folder given the same name as the screen data in the TS unit is selected from storage. The selected folder name is displayed.

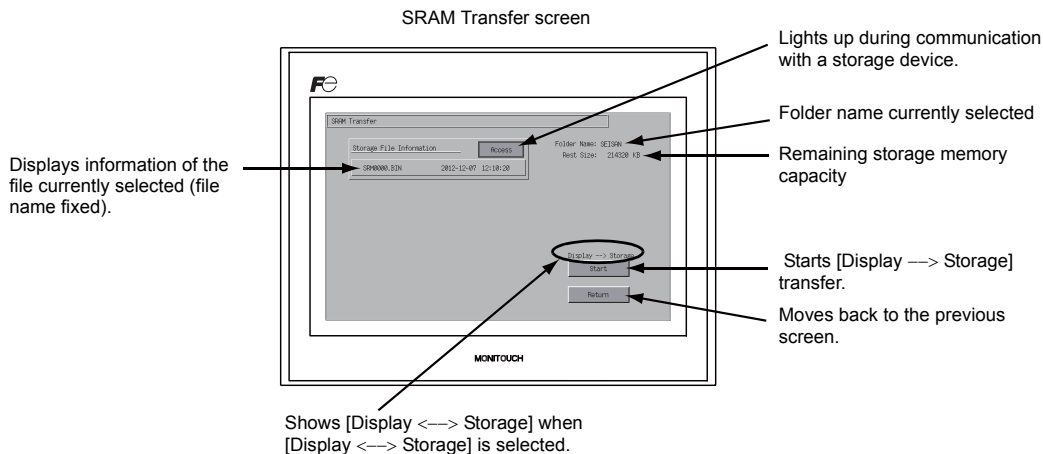

- When [Display ← Storage] is Selected:

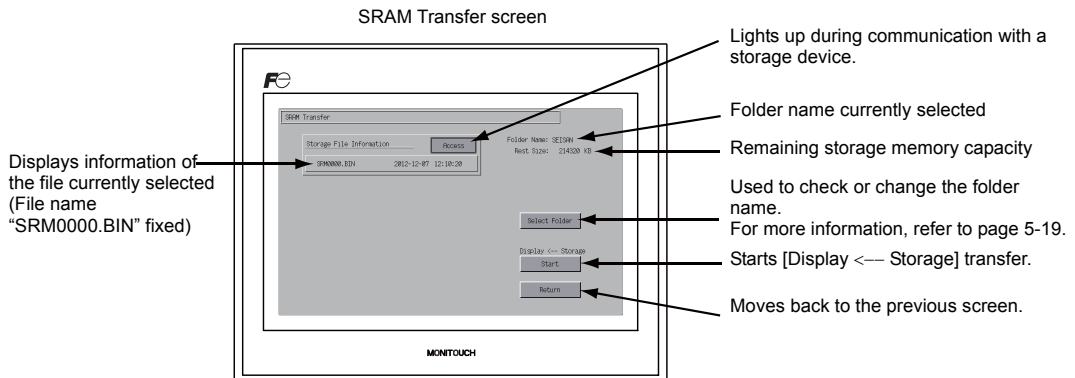

4. Transfer or comparison start
Check [Folder Name], [Rest Size], and the transfer direction. Press the [Start] switch. During data transfer or comparison, the [Start] switch changes to [Transferring].

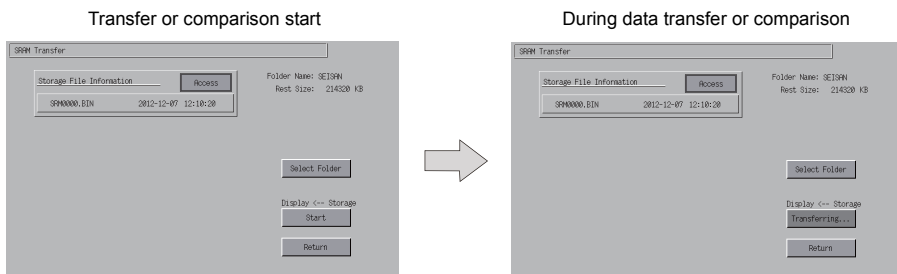

5. Data transfer completed
On successful completion, the following message dialog is displayed. Press the [OK] switch.

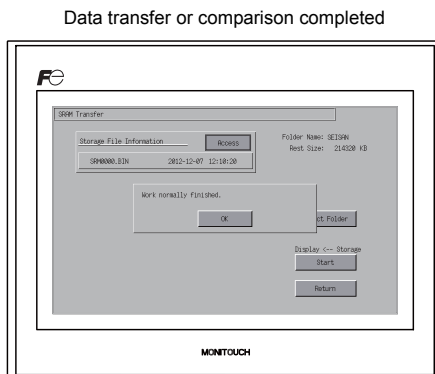

* If any other message is displayed, refer to "Message Dialog Displayed during Data Transfer (between TS and Storage)" (page 5-27).

7-4. Storage Data Deletion

Data can be completely deleted from storage. To delete data, follow the procedures described below.

1. Transfer operation selection

Select [Delete] in the [Transfer Menu] field to display the Delete Data in Storage screen. To move back to the previous screen, press the [Return] switch.

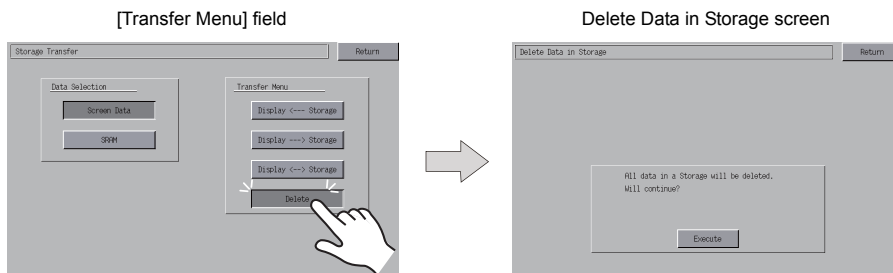

2. Execution of data delete to during execution

Press the [Execute] switch if deleting all data from storage. The switch is lit for a while.

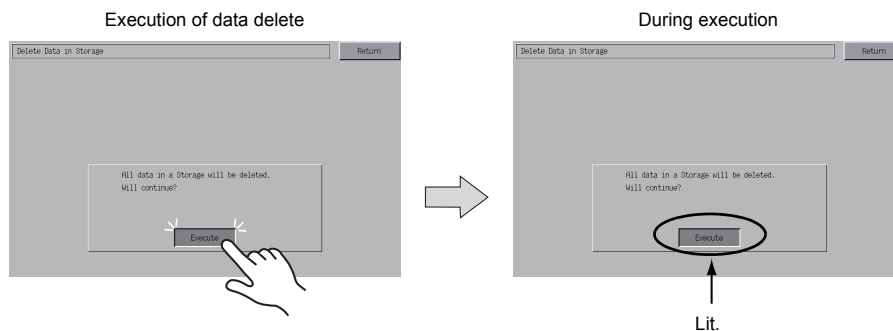

3. Data delete completed

When the data has been completely deleted, the message "Deleting Completed" is displayed. Data is completely deleted. Press the [Return] switch. The Storage Transfer screen is displayed again.

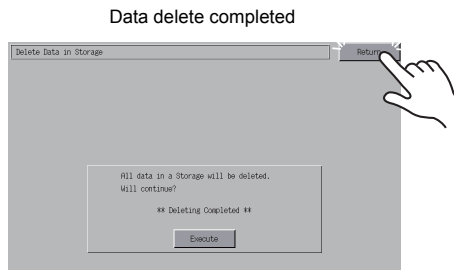

* Data in storage is completely deleted. However, redisplaying the Main Menu screen by the [Return] switch will automatically create the access folder of the screen data transferred to MONITOUCH.

7-5. Message Dialog Displayed during Data Transfer (between TS and Storage)

If an error occurs during data transfer, the message dialog shown on the right is displayed.



Messages and their contents are shown below.

Messages	Contents	Storage
Work normally finished.	The specified operation has been concluded normally.	○
Storage is not connected.	No storage device is inserted.	○
Storage Capacity over	Cannot write data to a storage device because the data size in the TS unit is larger than the capacity of the storage device.	○
Write Protect: ON	Cannot write data to a storage device because the device is write-protected with the write-protect switch.	-
Writing Error occurred.	An error occurred during writing to a storage device.	○
Selected data does not exist.	The data does not exist in the reading target.	○
Data type is different.	When writing to the TS unit, the type of data in storage does not match the model of the TS unit.	○
Selected data can not be read.	The data in storage cannot be read.	○
Reading Error occurred.	An error occurred during writing to the flash ROM in the TS unit.	○
Data discrepant	Data comparison found a discrepancy between the storage device and the TS.	○
Screen data on TS will be broken.	Warning about data destruction in the TS unit that may occur when transferring font data larger than the present data from storage to the TS unit. (When you press the [OK] switch to continue, transfer the screen data again.)	○
Undefined Error occurred.	An error occurred due to a cause other than those mentioned above.	○
Invalid format.	The format of the file system in storage cannot be identified. Reformat it to FAT or FAT32 in the computer.	○

8. Brightness Adjustment

Pressing the [Bright Adjustment] switch on the Main Menu drop-down window brings up the Bright Adjustment screen. This screen is used to adjust the brightness of the TS series.

Main Menu drop-down window

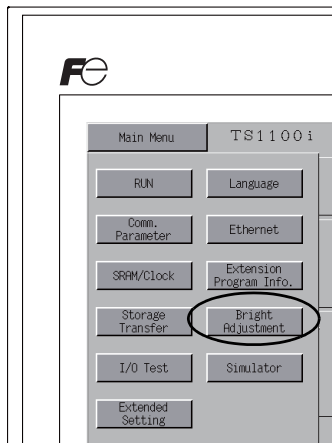

Bright Adjustment screen

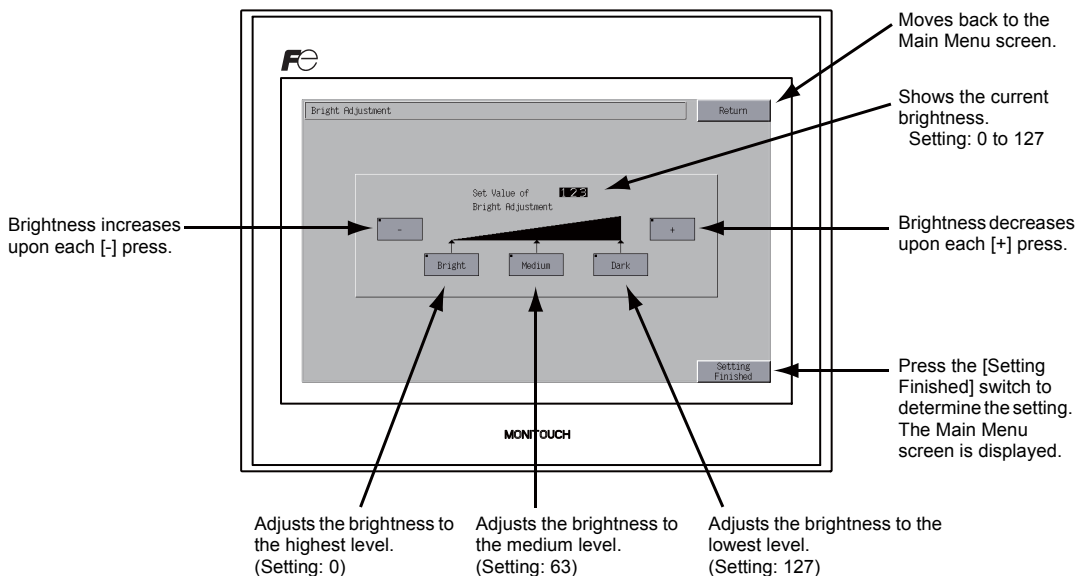

9. I/O Test

Pressing the [I/O Test] switch on the Main Menu drop-down window brings up the I/O Test screen. This screen is used to check that there is no problem with the TS interfaces and touch switch operation.

Main Menu drop-down window

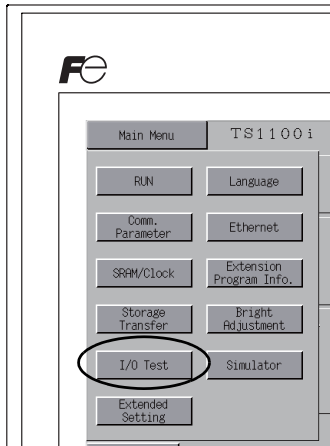

I/O Test screen

Moves to the touch switch test screen. (page 5-35)

Used to check USB connections. (page 5-34)

Performs a COM1/COM2/COM3 interface test. (page 5-30)

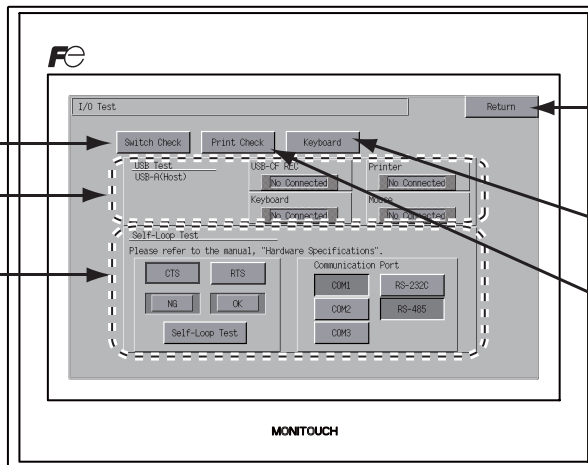

Moves back to the Main Menu screen. (page 5-3)

Moves to the Keyboard Selection screen. (page 5-37)

Moves to the Print Test screen. (page 5-34)

9-1. Self-loop Test

This is a signal test for communications through the COM1, COM2 or COM3 connector. Perform this test if the communication is not successfully established when connecting a controller (PLC, temperature controller, etc.) using COM1, COM2 or COM3.

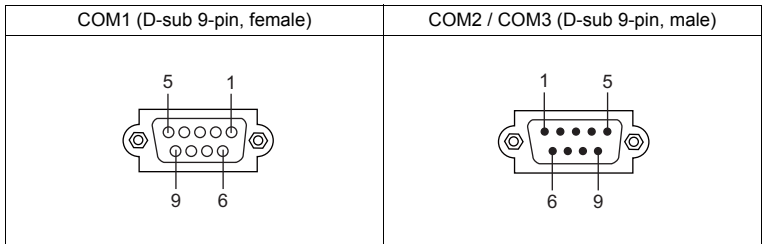

COM1: RS-485 Signal Test

SD/RD Test

Check the signals [SD] and [RD].

- Set DIP switch Nos. 2 and 3 to OFF.
 - * Turn the power off when setting DIP switches.
- Install a jumper between pins 1 and 4, and between pins 2 and 3 of COM1 on the TS series.

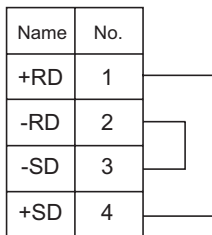

- Press the [COM1] switch in the [Communication Port] field. The [RS485] lamp comes on.

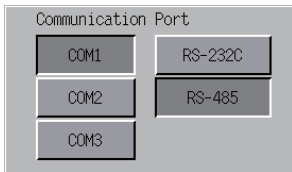

- Press the [Self-Loop Test] switch. When the [OK] lamp lights up, the test is successfully completed.

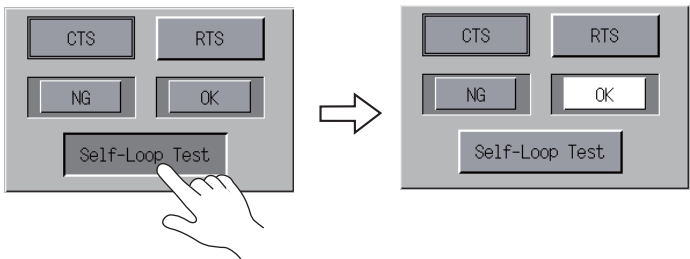

* If the [NG] lamp lights up, a pin may be faulty. Contact your local distributor.

COM2: RS-232C Signal Test

SD/RD Test

Check the signals [SD] and [RD].

1. Install a jumper between pins 2 and 3 of COM2 on the TS series.

Name	No.
RD	2
SD	3



2. Press the [COM2] switch in the [Communication Port] field. The [RS232C] lamp comes on.

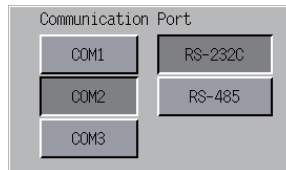

3. Press the [Self-Loop Test] switch. When the [OK] lamp lights up, the test is successfully completed.

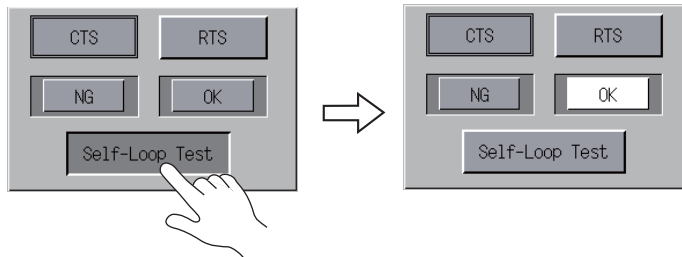

* If the [NG] lamp lights up, pin 2 or 3 may be faulty. Contact your local distributor.

CTS/RTS Test

Check the signals [CTS] and [RTS].

1. Install a jumper between pins 7 (RTS) and 8 (CTS) of COM2 on the TS series.

Name	No.
RTS	7
CTS	8



2. Press the [COM2] switch in the [Communication Port] field. The [RS232C] lamp comes on.

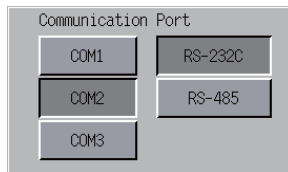

3. Press the [RTS] switch and check that both [RTS] and [CTS] lamps light up at the same time. Press the [RTS] switch again and check that both [RTS] and [CTS] lamps go off at the same time.

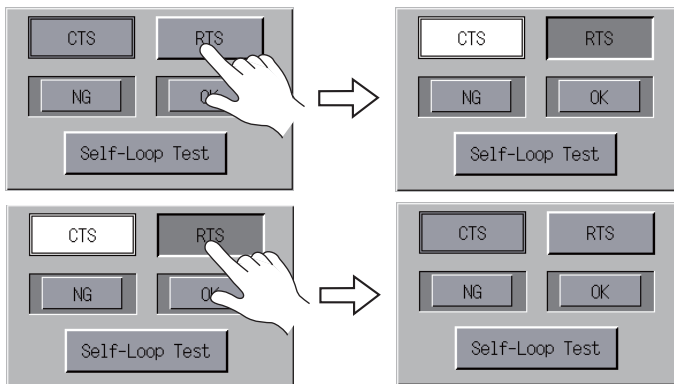

COM3: RS-485 Signal Test

SD/RD Test

Check the signals [SD] and [RD]. Be sure that no problem is found in "COM1: RS-485 Signal Test" (page 5-30) beforehand.

- Set DIP switch Nos. 2 and 3 to ON.
 - * Turn the power off when setting DIP switches.
- On the TS series, connect pin 1 of COM1 with pin 6 of COM3, and pin 2 of COM1 with pin 1 of COM3.

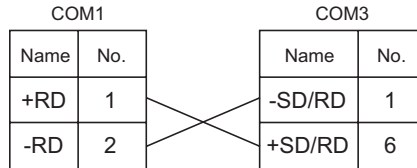

- Press the [COM3] switch in the [Communication Port] field. The [RS485] lamp lights up.

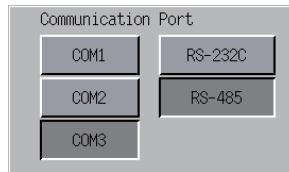

- Press the [Self-Loop Test] switch. When the [OK] lamp lights up, the test is successfully completed.

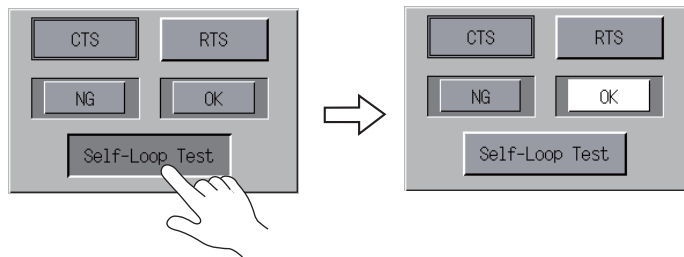

- * If the [NG] lamp lights up, a pin may be faulty. Contact your local distributor.

9-4. Touch Switch Test

If a touch switch does not activate at all or if an operation is performed without pressing any touch switch, check if the touch switches on the TS panel are working properly.

1. Touch switch test screen:
Press the [Switch Check] switch. Grids appear on the screen as shown below.

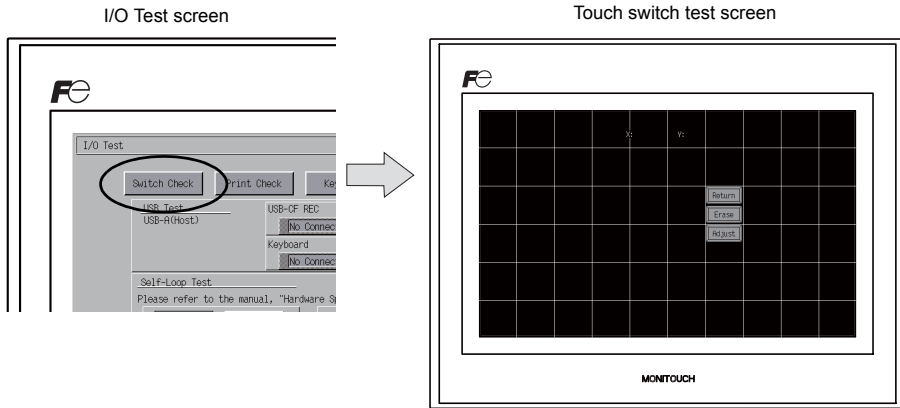

2. Checking the switch output state:
Press a position on the panel, and check if the pressed position turns white. When the pressed position turns white, the switch is activated normally. To move back to the I/O Test screen, press the [Return] switch. To delete white dots, press the [Erase] switch.

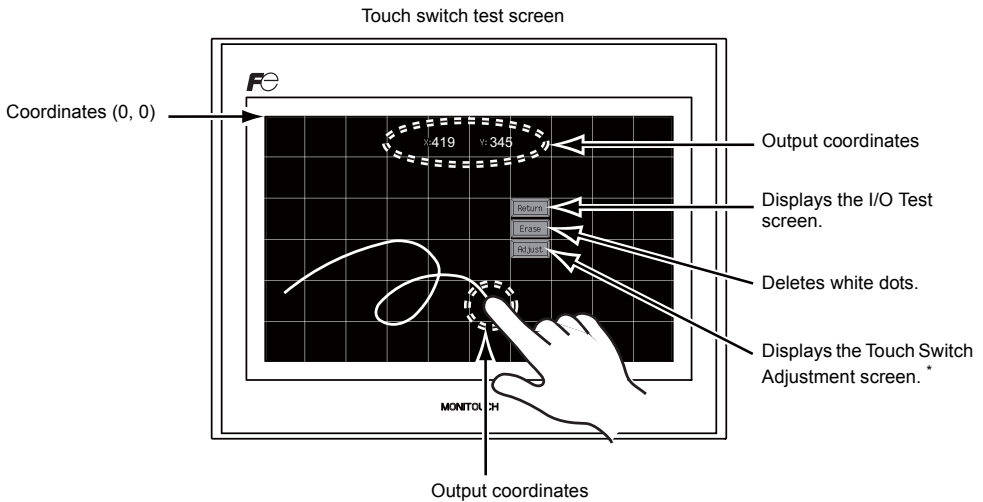

* If a position different from the pressed position turns white, refer to "Touch Switch Adjustment" on the next page and adjust the touch switch position.

Touch Switch Adjustment

If a position different from the pressed position turns white on the touch switch test screen, follow the steps described below to adjust the touch switch position.

1. Press the [Adjust] switch on the touch switch test screen. The Touch Switch Adjustment screen appears.

Touch switch test screen

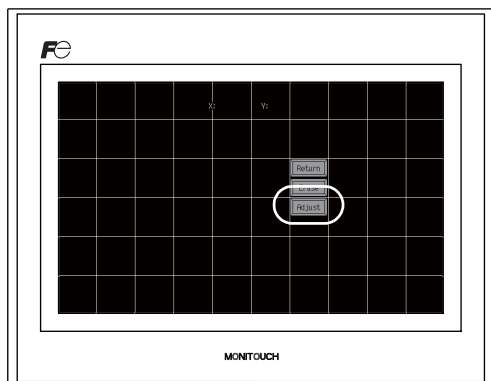

Touch Switch Adjustment screen

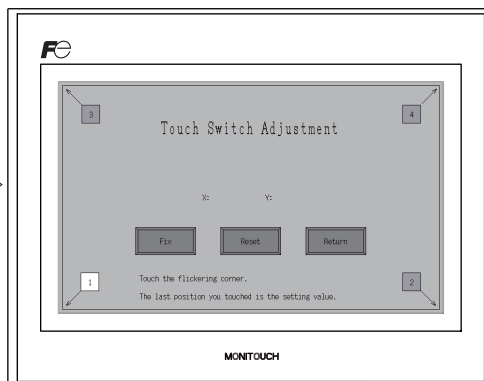

2. Press on "1" that is flashing at the corner. When the finger is released, a beep sounds and the position is set. "2" flashes.
3. Press on "2" that is flashing at the corner. When the finger is released, a beep sounds and the position is set. "3" flashes.
4. Press on "3" that is flashing at the corner. When the finger is released, a beep sounds and the position is set. "4" flashes.
5. Press on "4" that is flashing at the corner. When the finger is released, a beep sounds and the position is set.

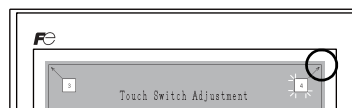
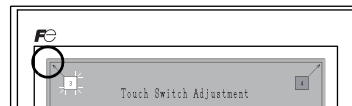
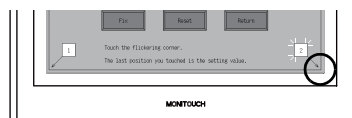
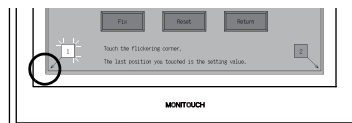

6. To re-set the positions, press the [Reset] switch and follow step 2 and later.
7. To cancel the setting, press the [Return] switch. The touch switch test screen is displayed again.
8. To determine the setting, press the [Fix] switch. A long beep sounds and the positions are determined. The touch switch test screen is displayed again.

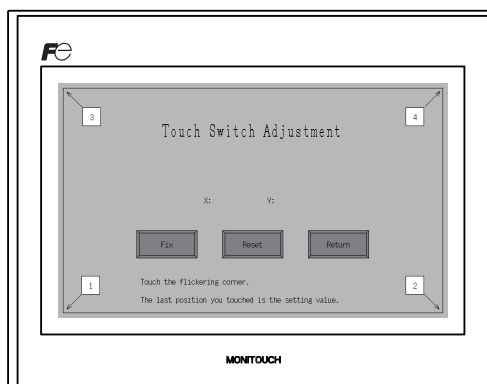

9-5. Keyboard Selection

This section describes how to select the type of the keyboard to be connected to the USB-A (master) port.

1. Keyboard Selection screen
Press the [Keyboard] switch to display the Keyboard Selection screen.

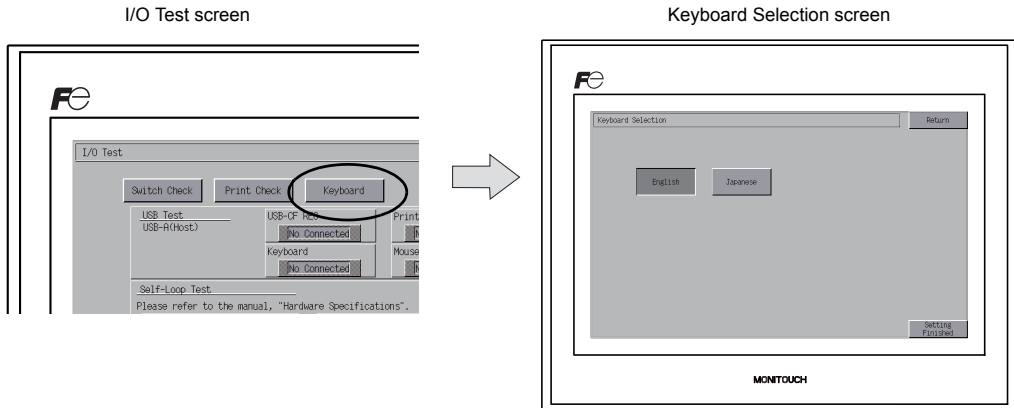

2. Keyboard type selection
Select the keyboard type by pressing the [English] or [Japanese] switch.

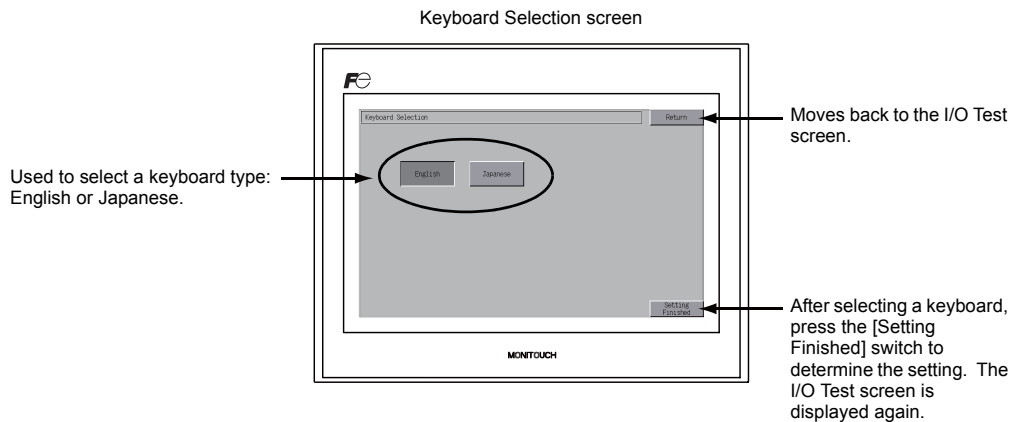

- * [English] is selected as the default.
After selecting a keyboard type from the Keyboard Selection screen and pressing the [Setting Finished] switch, the selected keyboard remains effective even after turning off and on the power.

3. Press the [Setting Finished] switch to determine the setting. The I/O Test screen is displayed again.

10. Extended Setting (TS1100i/TS1070i Only)

Pressing the [Extended Setting] switch on the Main Menu drop-down window brings up the Extended Setting screen.

Go to this screen when registering or unregistering the license for the remote desktop function.

Main Menu drop-down window

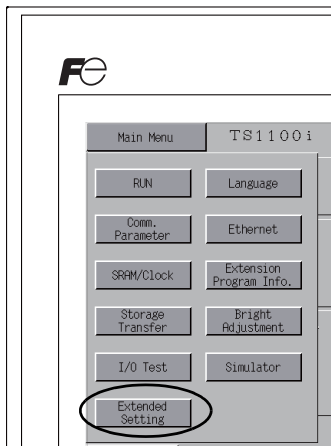

Extended Setting screen

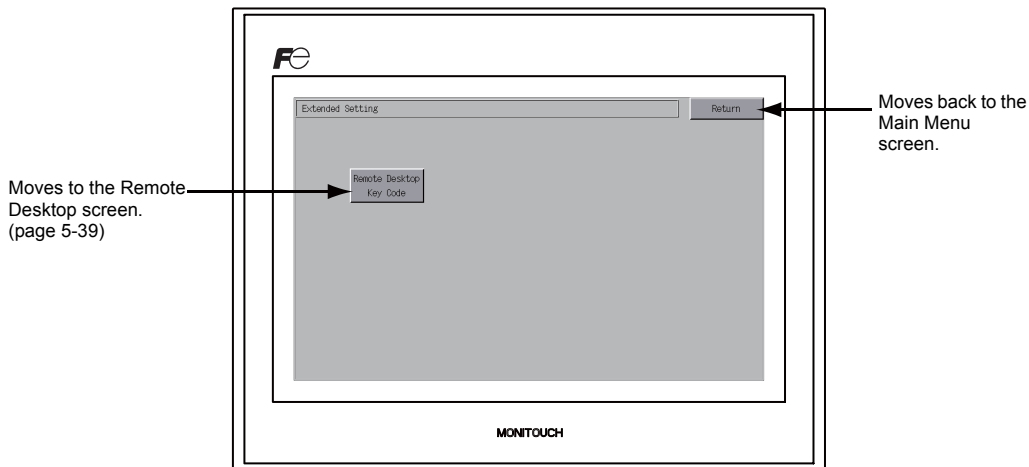

10-1. Registering/Unregistering the License for the Remote Desktop Function

Pressing the [Remote Desktop Key Code] switch on the Extended Setting screen brings up the Remote Desktop screen. This screen is used to register or unregister the license for the remote desktop function.

Licensing is required for using the remote desktop function.

One license is granted per TS unit.

- * For purchasing the license "V-RemoteDT", please consult with your local distributor.

Registering the License

1. Key in the key code (8 numerals) on the keypad and enter the code by pressing the [Setting Finished] switch.

Remote Desktop screen

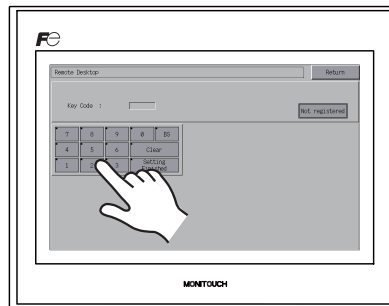

2. On completion of registration, the screen switches to the Main Menu screen.

Unregistering the License

The license registered with the TS series can be unregistered.

- * If using the remote desktop function again, reregister the key code. Be careful in managing the key code because it will not be reissued.

1. Press the [Delete] switch. When the dialog appears, press the [Execute] switch.

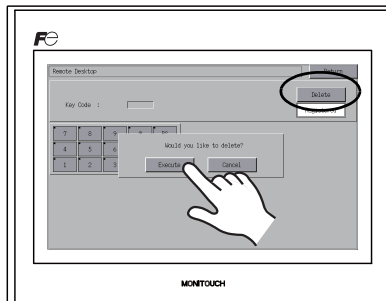

- The [Delete] switch disappears, and the [Not registered] switch appears instead.

Password unregistered

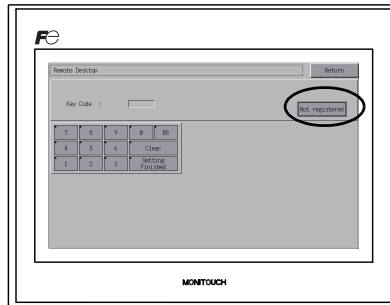

- The procedure for unregistering is complete.

11. Extended Function Setting

Holding down the [Editor: USB] switch for three seconds on the Main Menu screen displays the Extended Function Setting screen. This screen is used to set the local port number for V-Link, Modbus slave or multi-link communication.

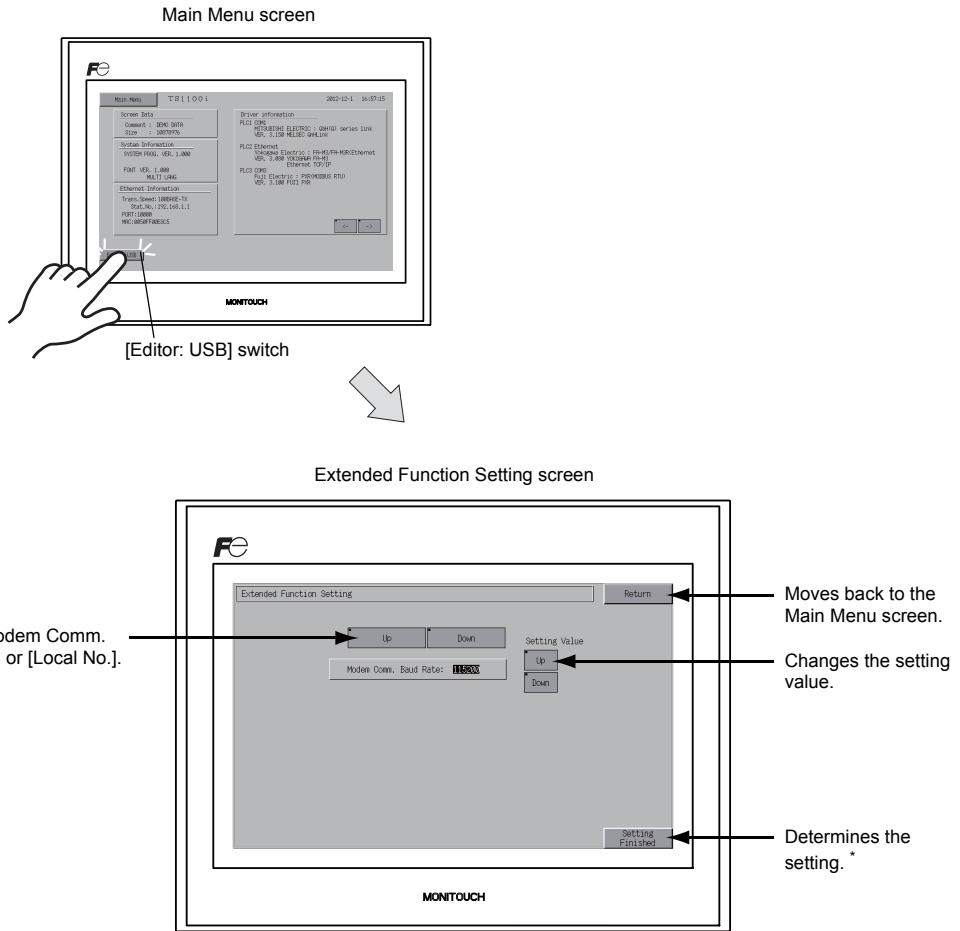

* The switches on the Main Menu screen are not valid for 15 seconds after the [Setting Finished] switch is pressed.

11-1. Setting Local Port Number

For V-Link, Modbus slave or multi-link communication, set the local port number from the Main Menu screen.

(The local port number can be set when [Set Local Port No. in Main Menu] is checked with [PLCn: V-Link] or [PLCn: Modbus Slave (RTU)] selected in the [Device Communication Setting] dialog ([System Setting] → [Device Connection Setting]) or with [Connection Mode: Multi-link] selected in the [Communication Setting] tab window ([System Setting] → [Device Connection Setting] → [Communication Setting]) on the V-SFT-5 editor.

1. Displaying the [Local No.] field:
Press the [Down] switch to display the [Local No.] field.
2. Setting the local port number:
Select a local port number using the [+] or [-] switch. The local port number can be selected from 1 to 254.
Press the [Setting Finished] switch to complete the setting.

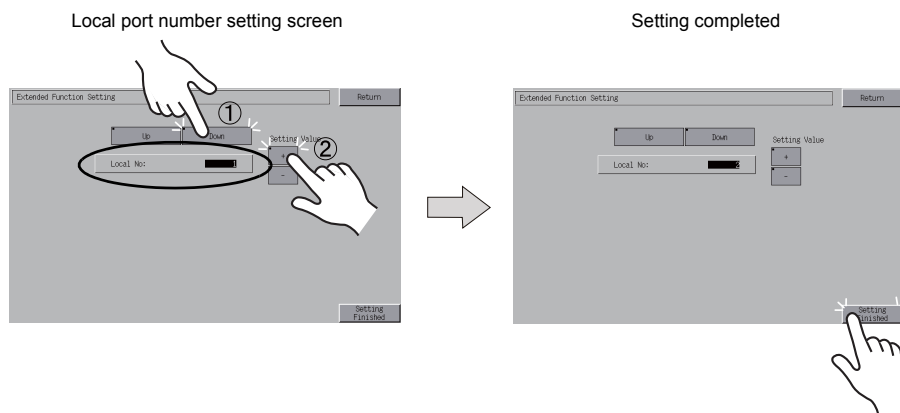

3. The Main Menu screen is automatically displayed again.

3. System Menu

Types of the System Menu Switches

System menu switches comprise four kinds of switches: [OFF], [MODE], [BR], and [BACK LT]. For the way to display the System Menu, refer to “Displaying the Main Menu Screen” on page 5-3.

Functions of the System Menu Switches

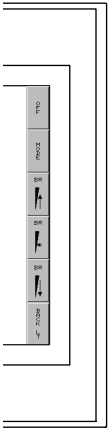
	Function	Specifications	TS	
OFF	System Menu hiding	Hides the System Menu.		
MODE	Mode selection	Switches the screen from the RUN mode to the System Menu.		
BR ↑	Brightness adjustment	Bright		
BR ←		Medium		
BR ↓		Dark		
BACK LT	Backlight control	Always ON		-
		Auto 1 Auto 2 Auto 3		<ul style="list-style-type: none"> The [BACK LT] switch turns the backlight off. This is available when the backlight control bit (bit 11) in the read area “n+1” in the system memory is reset (OFF: 0).
		Manual	The [BACK LT] switch turns the backlight off. To turn the backlight on, press somewhere on the screen.	

MEMO

Please use this page freely.

6 Error Handling

1. Error Messages
2. Troubleshooting

1. Error Messages

There are five kinds of error messages displayed on the TS series:

1. Communication Error
2. Data Loading
3. Warning
4. Touch switch is active.

1. Communication Error

When communication is not established between the TS series and a controller, or any abnormality (noise etc.) is detected, the following messages are displayed on the TS series.

- Comm. Error Handling: Continue
- Comm. Error Handling: Stop

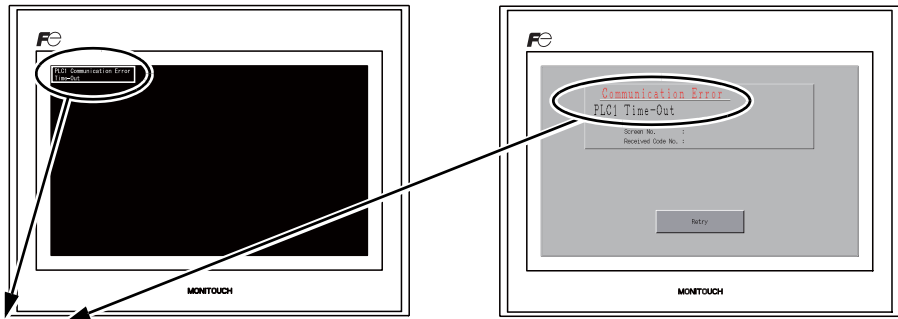

Error Messages	Contents	Solution	Remarks
Time-Out	Although a request to send is given to a controller, no answer is returned within the specified time.	1. Check settings in the [Communication Setting] tab window of the [Device Connection Setting] dialog.	1
		2. Check the cable connection.	
Parity	An error occurred in parity check.	3. Data may be disrupted because of noise. Fix noise.	2
		1. Check the cable connection.	1
Framing	Although the stop bit must be [1], it is detected as [0].	2. Data may be disrupted because of noise. Fix noise.	2
		1. Check settings in the [Communication Setting] tab window of the [Device Connection Setting] dialog.	1
Overrun	After one character is received, the next character is received before internal processing is completed.	2. Check the cables and wiring.	
		3. Data may be disrupted because of noise. Fix noise.	2
Check code error	The check code in the controller response was not correct.	1. Check settings in the [Communication Setting] tab window of the [Device Connection Setting] dialog.	1
		2. Data may be disrupted because of noise. Fix noise.	2

* If the above error messages are displayed on the TS series without establishing communication between TS and PLC, test the solution of remark "1". If the error occurs suddenly in communication, test the solution of remark "2".

Error Messages	Contents	Solution
Error code received	An error code was sent by a controller. (NAK)	Examine the controller error code and solve the problem.
Break	The controller's SD remains at the low level.	Examine the connection between the controller's SD and the TS's RD.
Invalid memory (Mitsubishi CPU)	You specified an address that exceeds the memory range of the PLC that you are linked to.	Check the type and range of memory that you set.
Format	The code of the received data is invalid.	<ol style="list-style-type: none"> 1. Confirm link unit settings. (After making settings, cut power to the controller.) 2. On the V-SFT-5 editor, select [System Setting] → [Device Connection Setting] and check the settings. 3. If errors only occur from time to time, a noise-based communication error may be present.
Compare (HIDIC S10)	Transmission data and received data are different.	
NAK	A NAK code is received.	
Transaction Error (Allen-Bradley PLC)	Transmitted transaction data and received transaction data are not in agreement.	
Communication Error	An unclear communication error is detected.	
Count error (Mitsubishi CPU and Q link unit)	The expected data amount is different from the count value.	
Command error (Mitsubishi CPU and Q link unit)	The response code differs from the expected code.	

2. Data Loading

If an error is detected on the screen data in the RUN mode, the following messages are displayed on the TS series.

Screen No. Error

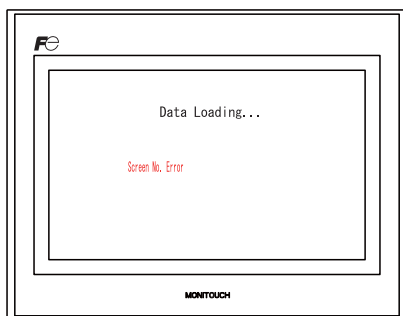

Error : XX (XX : XXX)

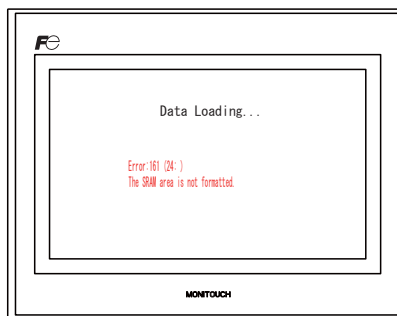

Error Messages	Contents	Solution
Screen No. Error	There is no setting for the received screen.	At the start of communications, the TS series regards the value in the read area "n + 2" as the screen number. Check that this value is an existing screen number on the controller.
Error : XX (XX : XXX)	There is an error in the created screen data.	<p>According to the item number and the sub-item number displayed on the TS series, find the edited screen where the error occurs. Check the contents of the error (error number) and remove the error.</p> <p>Error : XX (XX : XXX)</p> <ul style="list-style-type: none"> Sub-item No. Item No. Error No. <p>For details on the item number and sub-item number, refer to the TS Series Reference Manual.</p>

3. Warning

A message may be displayed on the Main Menu screen. This is a warning message. For the warning details and solutions, refer to the V8 Series Reference Manual and correct screen data.

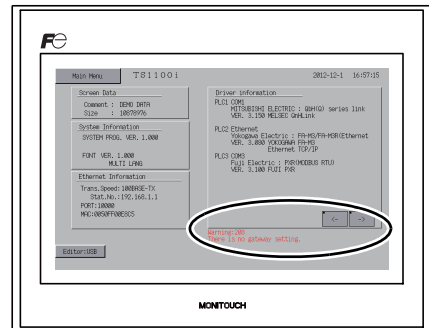

4. Touch Switch Is Active

If the power is turned off while a touch switch is activated, the error screen shown on the right is displayed. Remove your finger from the screen. If the error screen remains displayed, contact your local distributor.

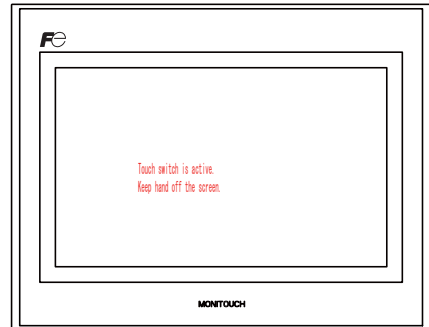

2. Troubleshooting

In the Event of an Error

Perform the steps below:

1. If the current error matches a symptom in the following table, correct it by following the instructions provided.
2. If the error does not match the symptoms in the table, contact your local distributor. Please provide the distributor with the information on the MONITOUCH model, serial number, symptom of the error, error message, etc.

Probable Symptoms

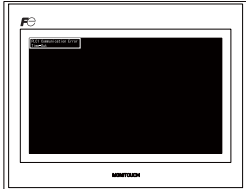
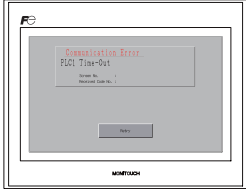
Symptom	Cause	Solution
<p>MONITOUCH is connected to controllers; however, communication fails. "Communication Error: Time-Out" appears on the screen.</p> <ul style="list-style-type: none"> • Comm. Error Handling: Continue  <ul style="list-style-type: none"> • Comm. Error Handling: Stop 	<p>Probable causes are:</p> <ol style="list-style-type: none"> 1) Cables are not connected correctly or any cable is disconnected. 2) Parameter settings in the controller are not correct or disagree with the TS-series settings. 3) The MONITOUCH is faulty. 	<p>Solutions are:</p> <ol style="list-style-type: none"> 1) Check the cable connection. 2) Recheck the parameter settings in the controller. 3) Perform a self-loop test on the I/O Test screen (page 5-30). If the test is not successful, please return MONITOUCH to your local distributor immediately.

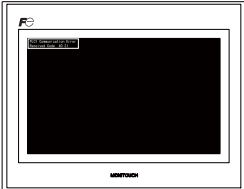
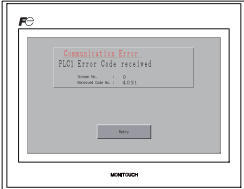
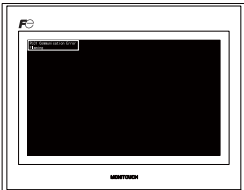
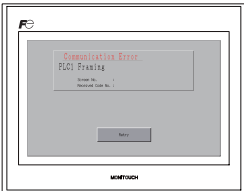
Symptom	Cause	Solution
<p>Communications have been successful. However, opening a certain page always causes a "Communication Error: Error Code xxxx" or "Communication Error: Error Code received" error.</p> <ul style="list-style-type: none"> Comm. Error Handling: Continue  <ul style="list-style-type: none"> Comm. Error Handling: Stop 	<p>The error code denotes a controller error (NAK).</p> <ol style="list-style-type: none"> When the error code appears only on a certain screen, a memory address that does not exist on the controller may be set on the TS-series screen. When the error code appears at power-on, the memory address set for buffering area or initial macro or in the [Read/Write Area] tab window ([System Setting] → [Device Connection Setting]) may not exist in the controller. 	<ol style="list-style-type: none"> Check if any address outside the allowable range for controller memory is set on the screen. Check if the address set for buffering area or initial macro or in the [Read/Write Area] tab window ([System Setting] → [Device Connection Setting]) is outside the allowable range for the controller memory.
<p>Communications have been successful. However, "Communication Error: Parity" or "Communication Error: Framing" suddenly occurs.</p> <ul style="list-style-type: none"> Comm. Error Handling: Continue  <ul style="list-style-type: none"> Comm. Error Handling: Stop 	<p>Noise may cause the error.</p>	<p>Check if appropriate measures are taken against noise.</p> <p>Example:</p> <ul style="list-style-type: none"> Check if communication and power cables are bundled together. Try to attach a ferrite core to the communication cable. Try to attach a noise filter to the power supply, etc.

Symptom	Cause	Solution
Switches do not work.	<p>1) Switches do not work in the RUN mode. A beep sounds. ↓ Is the switch interlock enabled?</p> <p>2) Switch activation position is wrong. On the I/O Test screen displayed from the Main Menu screen, press the [Switch Check] switch. On the touch switch test screen, a position different from the pressed position is activated. ↓ The switch activation position may be misaligned.</p> <p>3) Switches do not work even in the STOP mode. On the I/O Test screen displayed from the Main Menu screen, press the [Switch Check] switch. When the touch switch test screen is pressed, nowhere is activated. ↓ MONITOUCH switches may be faulty.</p>	<p>1) Check the settings of switch functions, etc. on the V-SFT-5 editor.</p> <p>2) Perform a touch switch adjustment (page 5-36).</p> <p>3) Return MONITOUCH to your local distributor.</p>
The screen becomes dark or black.	<p>1) Touching the screen restores it to the previous illuminated state. ↓ The backlight operates automatically as preset.</p> <p>2) Touching the screen does not restore it. ↓ The backlight may be at the end of its life. Or MONITOUCH may be faulty.</p>	<p>1) The time for turning off the backlight can be changed on the V-SFT-5 editor.</p> <p>2) Return MONITOUCH to your local distributor.</p>
Screen data cannot be transferred.	<p>1) An error is displayed on the computer when screen data is transferred. ↓ There may be some errors in the Ethernet or USB settings.</p>	<p>1) Transfer via USB Is the USB driver identified? Is the driver installation successfully finished (page 2-19)?</p> <p>Transfer via Ethernet Check that the IP addresses set on the V-SFT-5 editor and MONITOUCH are the same. Also check if any error due to Ethernet connection occurs on MONITOUCH.</p> <p>If the problem persists, contact your local distributor.</p>

7 Inspection and Maintenance

1. Inspection and Maintenance
2. Warranty Policy

1. Inspection and Maintenance

**DANGER**

Be sure to turn off the power before conducting inspection or maintenance. Failure to do so could cause an electric shock or damage to the unit.

Daily Inspection

- Check that the nuts on the TS series are tightened firmly.
- Check that the connectors and terminal screws used for connection with other devices are tightened firmly.
- If the display surface or frame is dirty, wipe it with a soft cloth soaked in alcohol (commercially available).
- Conduct periodical inspection once or twice a year. The number of inspections may be increased as necessary if facilities are relocated or modified, or the environment is hot, humid, or dusty.

Periodical Inspection

Inspect the following points periodically.

- Are the ambient temperature and humidity appropriate?
0 to +50 °C, 85 %RH or less
- Are the environmental conditions appropriate?
No excessive dust, and no conductive dust
- Is there corrosive gas in the atmosphere?
- Is the source voltage in the allowable range?
With CD power supply: 24 VDC \pm 10 %
- Are the nuts on the TS series tightened firmly?
- Are the connectors and terminal screws used for connection with other devices tightened firmly?
- Is a coin-type lithium battery within the expiry date used?
Within about 3 years from the date of manufacture

2. Warranty Policy

Inquiries about Failure

Please direct inquiries about failure or repair to your local distributor. Your information on the MONITOUCH model, serial number, symptom of the failure, error message (if shown), etc. will be appreciated.

- * An inquiry form is provided on the final page (page 7-3) of this chapter. The form may be used for your inquiry.

Warranty Period

The product is under warranty for one year after the date of purchase or delivery to the specified place. On the assumption that the maximum stock period of the product after manufacture is 6 months, the warranty period is limited to 18 months (checked by the serial number) after manufacture. When a warranty period is specified in the contract, however, the period in the contract takes precedence.

Free-of-charge Repair

If the product fails before the expiry of the warranty, it will be repaired free of charge. However, repair of any failure resulting from the causes below will be chargeable even within the warranty period.

- Breakage of or damage to the appearance (case or surface sheet), touch switches, LCD, or other components due to dropping, impact, or mishandling
- LCD or backlight at the end of life
- Fusion of a printed circuit board pattern associated with connection to external devices, or fusion of a pattern in the terminal block or connector section of a printed circuit board caused by short-circuiting of external load circuit.
- Overvoltage or different voltage applied due to wiring mistakes (power supply terminal, external communication terminal, or other terminal blocks)
- Failure caused by lightning surge
- Failure due to the entry of conductive substances, water, solvent, particles, etc. under inappropriate environmental conditions
- Failure due to inappropriate environmental conditions (e.g. corrosive gas or high humidity)
- Failure due to vibration or impact exceeding the specified level
- Disassembly and modification by the customer or failure obviously resulting from improper handling by the customer

Chargeable Repair

Any failure that occurs after the expiry of the warranty or does not satisfy the requirements for the free-of-charge repair will be repaired on a chargeable basis.

Inquiry Form

Your name			
Company name			
Contact	Phone		Fax
	E-mail		
Model code (*1)			Ser. No. (*1)
MONITOUCH version (*2)	SYSTEM PROG. Ver. :		I/F DRV. Ver.:
Purchased from: (Distributor)			
Person in charge			Date of purchase
Symptom			
(Please describe the symptom of the failure and also include the error message if any is displayed.)			

*1 See the label on the back of MONITOUCH for the model code and serial number (seven digits plus one letter of the alphabet).
 *2 Enter the version if it can be checked.
 The version is displayed on the Main Menu screen (page 5-3).

MEMO

Please use this page freely.

Hakko Electronics Co., Ltd.
www.monitouch.com

Sales 890-1, Kamikashiwano-machi, Hakusan-shi, Ishikawa,
924-0035 Japan
TEL +81-76-274-2144 FAX +81-76-274-5136