

TS3000 series Robot Controller

TS3000 SCARA / LINEAR system
TS3100 SCARA / LINEAR system
TSL3000 SCARA system

INSTRUCTION MANUAL

OPERATOR'S MANUAL

Notice

- Make sure that this instruction manual is delivered to the final user of Toshiba Machine's industrial robot.
- Before operating the industrial robot, read through and completely understand this manual.
- After reading through this manual, keep it nearby for future reference.

TOSHIBA MACHINE CO., LTD.

Copyright 2012 by Toshiba Machine Co., Ltd.
All rights reserved.

No part of this document may be reproduced in any form without obtaining prior written permission from Toshiba Machine Co., Ltd.

The information contained in this manual is subject to change without prior notice to effect improvements.

Preface

Structure of TS series robot controller instruction manuals:

These instruction manuals were published in parts according to the application and purpose, and the name and outline of each manual are as follows:

[Safety Manual]

This manual contains the important information to use the robot safely and correctly. Be sure to read through and understand this manual before operating the robot. Also, strictly observe the descriptions made there.

[Startup Manual]

This manual describes the procedures covering from power ON of the robot after installation to robot operation by manual guide. When you use the TS series robot controller for the first time, be sure to read through this manual.

[Operator's Manual]

This manual deals with the TS series robot controller operating procedures. Read through this manual before operating the robot, and refer to it as necessary.

[Robot Language Manual]

This manual refers to the robot language called "SCOL". When you have to create a program based on this language, read through the manual.

[Interface Manual]

This manual describes the external signals for the robot. Concerning the interface conditions between the robot and peripheral equipment, specifications, timing, etc., refer to the manual when necessary.

[Installation & Transport Manual]

This manual describes the transport, unpacking and installation of the robot and controller. Be sure to read through this manual before unpacking the shipment containing the robot.

[Maintenance Manual]

This manual deals with the daily and regular inspections to be made on the robot and controller. Read through this manual to use the robot safely over long years to come.

[Communication Manual]

This manual describes the serial communication between the robot controller and other equipment. Refer to this manual when connecting the robot controller with a host computer, optical sensor, etc., via a serial cable.

[User Parameter Manual]

This manual describes the setting procedures of the robot controller. Refer to this manual when you perform the setting of communication, I/O and motion conditions.

[Alarm Manual]

This manual describes the contents, causes, and remedies of alarms. Refer to this manual when an alarm occurs.

This manual describes how to use various functions of the robot system to manually guide the robot, edit programs, compile data and perform automatic operation through the control panel (TS3000 controller front switches 3) and the teach pendant.

This manual is intended for the robot operator.



Before reading this manual, he or she should first read the Safety Manual and Startup Manual.

Cautions on Safety

This manual contains the important information on the robot and controller to prevent injury to the operators and persons nearby, to prevent damage to assets and to assure correct use.

Make sure that the following details (indications and symbols) are well understood before reading this manual. Always observe the information that is noted.





[Explanation of indications]

Indication	Meaning of indication
 DANGER	This means that "incorrect handling will lead to fatalities or serious injuries."
 CAUTION	This means that "incorrect handling may lead to personal injuries *1) or physical damage *2).

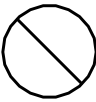

*1) Injuries refer to injuries, burns and electric shocks, etc., which do not require hospitalization or long-term medical treatment.



*2) Physical damage refers to damages due to destruction of assets or resources.

[Explanation of symbols]

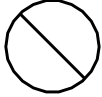
Symbol	Meaning of symbol
	This means that the action is prohibited (must not be done). Details of the actions actually prohibited are indicated with pictures or words in or near the symbol.
	This means that the action is mandatory (must be done). Details of the actions that must be done are indicated with pictures or words in or near the symbol.
	This means danger. Details of the actual danger are indicated with pictures or words in or near the symbol.
	This means caution. Details of the actual caution are indicated with pictures or words in or near the symbol.

[Operation]

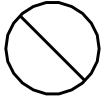
 DANGER	
 Prohibited	<ul style="list-style-type: none"> • During operation, NEVER enter the dangerous area of the robot. Otherwise, you will be injured seriously. • DO NOT leave in the working range any machinery or materials which will hinder the operation. If the equipment went wrong, a person nearby will be injured or involved in an accident. • Anyone other than the operator MUST NOT approach the equipment. Should he negligently touch the dangerous part of the equipment, he will get injured or involved in a serious accident. • NEVER perform an inappropriate operation which is not described in the instruction manual. Otherwise, the equipment will start by mistake, resulting in personal injury or serious accident.
 Danger	<ul style="list-style-type: none"> • If you feel even a little that you are exposed to danger or that the equipment works abnormally, press the EMERGENCY stop pushbutton switch to stop the equipment. If the equipment is used as it is, you will be injured or involved in a serious accident. When this happens, ask our after-sale service agent for repair. • During operation, be sure to close the equipment cover. Should the cover be opened during operation, you will be struck by an electric shock or get injured. • Only a well-trained and qualified person is allowed to perform the operation. Should the equipment be operated improperly, it will start by mistake, causing a personal injury or serious accident. • If the equipment has malfunctioned, turn the power off, identify and remove the cause of the abnormality, maintain the peripheral equipment and completely restore the malfunctioned equipment. Then start the equipment at a slow speed. If the equipment starts, leaving the abnormality, you will be involved in a serious accident.

 CAUTION	
 Prohibited	<ul style="list-style-type: none"> • DO NOT change the data of the system structure file. Otherwise, the robot will move abnormally, resulting in damage or an accident.
 Mandatory	<ul style="list-style-type: none"> • In principle, teaching operation should be performed outside the dangerous area of the robot. If it should be performed inevitably within the dangerous area, strictly observe the following matters. <ol style="list-style-type: none"> (1) The teaching operation should always be performed by two (2) persons. One person performs the job and the other person watches outside the dangerous area. Also, both persons should try to prevent mis-operation with each other. (2) The operator should do the job in an attitude ready to press the EMERGENCY stop pushbutton switch at any time. Also, he should perform the job at a position from which he can evacuate immediately at the time of an emergency after confirming the robot working range and shields nearby. (3) The supervisor should keep watch on the job at a position where he can see the entire robot system and operate the EMERGENCY stop pushbutton switch at the time of an emergency. Also, he should keep anyone from entering the dangerous area. Unless the operator or other person follows the instructions of the supervisor, an accident will be caused. • If an abnormality has generated or the POWER LED lamp remains off after the main power switch of the equipment was turned on, turn off the main power immediately and confirm the wiring. Otherwise, you will be struck by an electric shock or a fire will break out. • Unless the robot operates toward a designated direction at manual guide, turn off the servo power. Otherwise, the robot will be damaged or you will be involved in an accident. When this happens, call the after-sale service agent. • Pushbutton operations of the control panel and teach pendant should be confirmed visually. Otherwise, you will be involved in an accident due to mis-operation. • After the power is turned on, be sure to reset a program to start an automatic operation. If the program is executed continuously, the robot will interfere with the peripheral equipment, resulting in damages or accidents.



 CAUTION	
 Mandatory	<ul style="list-style-type: none"> • Before operating the equipment, perform the following inspection. <ol style="list-style-type: none"> (1) Make sure that visual appearance of the robot, controller, peripheral equipment and cables is in the good condition. (2) Make sure that no obstacle stands in or near the working range of the robot and peripheral equipment. (3) Make sure that the emergency stop and other safety devices operate properly. (4) Make sure that no abnormal noise or vibration is involved in the robot operation. <p>If the above prior inspection is skipped, the equipment will be damaged or you will be involved in an accident.</p>
 Caution	<ul style="list-style-type: none"> • The speed of test operations is initially set at 25% of the maximum robot speed. • The speed of automatic operation is initially set at 100% of the maximum robot speed.

Table of Contents

	Page
Section 1 Before Operating Your Robot	1-1
1.1 Overview of Operation Functions.....	1-1
1.2 Mode Structure	1-3
1.2.1 External Automatic Mode	1-4
1.2.2 Internal Automatic Mode.....	1-5
1.2.3 Teaching Mode (Including Test Operation)	1-6
1.2.4 Edit	1-7
1.3 General Operation	1-8
1.3.1 Entry of Alphanumeric Characters and Symbols	1-9
1.3.2 Combined Key Operation	1-10
1.3.3 Use of Function Keys	1-11
1.3.4 Repeating an Entry.....	1-12
1.3.5 Correcting Incorrect Entries.....	1-12
1.3.6 Canceling an Entry	1-13
1.3.7 Use of Wild Cards (*).....	1-13
1.3.8 Format for Operating Instructions.....	1-14
1.4 Assigning Names.....	1-15
1.4.1 Assigning a File Name.....	1-15
1.4.2 Assigning a Point Name	1-16
1.4.3 Assigning a Name to Coordinate Data	1-17
1.4.4 Assigning a Name to Load Data.....	1-18
1.5 File.....	1-19
1.5.1 Kind of File	1-19
1.5.2 Batch File	1-21
1.5.3 Backup	1-21
Section 2 Basic Operation	2-1
2.1 Basic Operating Procedures	2-1
2.2 Main Power and Servo Power of TS3000 Controller.....	2-2
2.2.1 Control Panel (TS3000).....	2-2
2.2.2 Turning ON the Main Power (TS3000)	2-4
2.2.3 Turning ON the Servo Power	2-6
2.2.4 Turning OFF the Servo Power (TGS3000)	2-6
2.2.5 Turning OFF the Main Power (TGS3000).....	2-9

2.3	Main Power and Servo Power of TSL3000 Controller.....	2-10
2.3.1	Controller Front Panel (TSL3000).....	2-10
2.3.2	Turning ON the Main Power	2-11
2.3.3	Turning ON the Servo Power	2-12
2.3.4	Turning OFF the Servo Power	2-14
2.3.5	Turning OFF the Main Power	2-15
Section 3	Teaching Operation	3-1
3.1	Selecting the Teaching Mode	3-1
3.2	Guidance Coordinates	3-3
3.3	Guide Mode	3-4
3.4	Guide Speed.....	3-5
3.5	Guidance	3-6
3.6	Servo Free	3-7
Section 4	Program Editing.....	4-1
4.1	Starting Up the Program Editor [EDIT].....	4-1
4.2	Character Input	4-5
4.2.1	Character Input Mode Selection	4-5
4.2.2	Insert Mode [INS]	4-6
4.2.3	Replace Mode [Replace]	4-9
4.2.4	Input Correction [BS]	4-11
4.2.5	Character Deletion [DEL].....	4-12
4.2.6	Moving the Cursor [↑] [↓] [←] [→].....	4-13
4.3	Edit Command Input	4-14
4.3.1	List of Edit Commands	4-14
4.3.2	Command Menu Selection	4-15
4.3.3	Input Correction [BS]	4-16
4.3.4	Cancel [ESC].....	4-17
4.4	Descriptions on Edit Commands.....	4-18
4.4.1	Data Editing [DEDIT]	4-18
4.4.2	Jump to Specified Line [JUMP]	4-18
4.4.3	Deleting Block [CUT]	4-20
4.4.4	Copying [COPY]	4-22
4.4.5	Pasting [PASTE].....	4-24
4.4.6	Searching Character String [FIND].....	4-26
4.4.7	Replacing Character String [CHANG].....	4-28
4.4.8	Quit [SAVE]	4-32

4.4.9	Aborting and Quitting Edit [NOSAVE].....	4-33
4.5	Automatic Start File.....	4-34
Section 5	Data Editing.....	5-1
5.1	Starting Up the Data Editor.....	5-1
5.2	Positional Data Directory Display Mode.....	5-3
5.2.1	Editing of Positional Data Name.....	5-7
5.2.2	Editing of Position Element.....	5-10
5.2.3	Addition of New Positional Data (INS).....	5-13
5.2.4	Deletion of Positional Data (ALT + BS).....	5-15
5.2.5	Quitting Data Editing [SAVE].....	5-16
5.2.6	Abortion and Quitting Data Editing [NOSAVE].....	5-18
5.2.7	Return to Program Editor [PRG].....	5-20
5.2.8	Call of Detailed Positional Data Display [FULL].....	5-21
5.2.9	Call of Coordinate Data Directory Display [TRANS].....	5-22
5.2.10	Call of Load Data Directory Display [PYLD].....	5-23
5.2.11	Search of Positional Data [FIND].....	5-24
5.2.12	Teach of Positional Data [TEACH].....	5-27
5.2.13	Move to Teach Point [M-TO].....	5-29
5.2.14	Cut of Positional Data [CUT].....	5-31
5.2.15	Paste of Positional Data [PASTE].....	5-34
6.2.16	Move to Teach Point [BYPAS].....	5-35
5.3	Detailed Positional Data Display Mode.....	5-39
5.3.1	Editing of Detailed Positional Data Name.....	5-42
5.3.2	Editing of Detailed Position Data Element.....	5-45
5.3.3	Call of Positional Data Directory Display [DIR].....	5-48
5.4	Coordinate Data Directory Display Mode.....	5-49
5.4.1	Addition of New Coordinate Data (INS).....	5-52
5.4.2	Deletion of Coordinate Data (ALT + BS).....	5-54
5.4.3	Call of Detailed Coordinate Data Display.....	5-55
5.4.4	Call of Load Data Directory Display [PYLD].....	5-56
5.4.5	Setting of Work Coordinate System (Call of Positional Data Directory Display) [WORK].....	5-57
5.4.6	Setting and Cancel of Tool Coordinate System [TOOL].....	5-58
5.4.7	Search of Coordinate Data [FIND].....	5-59
5.4.8	Cut of Coordinate Data [CUT].....	5-62
5.4.9	Paste of Coordinate Data [PASTE].....	5-65
5.5	Detailed Coordinate Data Display Mode.....	5-66

5.5.1	Editing of Coordinate Data Name	5-68
5.5.2	Editing of Coordinate Element	5-71
5.5.3	Teaching of Coordinate Data [TEACH].....	5-74
5.6	Load Data Display Mode.....	5-80
5.6.1	Editing of Load Data Name	5-83
5.6.2	Editing of Load Data Element.....	5-86
5.6.3	Addition of New Load Data [INS].....	5-89
5.6.4	Deletion of Load Data (ALT + BS).....	5-91
5.6.5	Call of Positional Data Directory Display [POINT]	5-92
5.6.6	Call of Coordinate Data Directory Display [TRANS]	5-93
Section 6	Test Operation.....	6-1
6.1	Selecting Test Operation Mode	6-2
6.2	Selecting File [SEL].....	6-4
6.3	Selecting Run Mode [MODE].....	6-6
6.4	Speed Override [OVRD]	6-8
6.5	Executing Program Step [STEP].....	6-10
6.6	Startup [RUN]	6-13
6.7	Stop	6-15
6.7.1	CYCLE Stop	6-15
6.7.2	STOP.....	6-17
6.7.3	BREAK	6-18
6.7.4	FEED HOLD	6-19
6.7.5	EMERGENCY Stop	6-21
6.8	Reset [RESET]	6-22
6.8.1	Program Reset	6-22
6.8.2	Step Reset.....	6-24
6.8.3	Cycle Reset	6-26
6.8.4	Output Signal Reset	6-28
6.8.5	Execution File Reset.....	6-30
6.9	Direct Execution [DO]	6-32
6.10	Variable Monitor.....	6-34
6.11	Display of Line to be Executed	6-36
6.12	Finishing Test Operation.....	6-39

Section 7	Internal Automatic Operation.....	7-1
7.1	Selecting Internal Automatic Operation Mode.....	7-2
7.2	Selecting File [SEL].....	7-4
7.3	Selecting Run Mode [MODE].....	7-6
7.4	Speed Override [OVRD]	7-8
7.5	Startup	7-10
7.6	Stop	7-11
	7.6.1 Cycle Stop	7-11
	7.6.2 STOP.....	7-12
	7.6.3 BREAK	7-13
	7.6.4 FEED HOLD	7-14
	7.6.5 EMERGENCY Stop	7-16
7.7	Reset [RESET]	7-17
	7.7.1 Program Reset	7-17
	7.7.2 Step Reset.....	7-19
	7.7.3 Cycle Reset	7-21
	7.7.4 Output Signal Reset	7-23
	7.7.5 Execution File Reset.....	7-24
7.8	Direct Execution [DO]	7-26
7.9	Variable Monitor.....	7-28
7.10	Display of Line to be Executed	7-32
Section 8	External Automatic Operation.....	8-1
8.1	Selecting External Automatic Operation Mode	8-2
8.2	Selecting File	8-5
8.3	Selecting Run Mode.....	8-7
8.4	Speed Override.....	8-8
8.5	Startup	8-9
8.6	Stop	8-10
	8.6.1 Cycle Stop	8-10
	8.6.2 STOP.....	8-11
	8.6.3 BREAK	8-12
	8.6.4 FEED HOLD	8-13
	8.6.5 EMERGENCY Stop	8-15
8.7	Reset	8-16
8.8	Variable Monitor.....	8-18

8.9	Display of Line to be Executed.....	8-22
Section 9	File Operation.....	9-1
9.1	Directory Display [DIR].....	9-1
9.2	File Copy [COPY].....	9-4
9.3	File Rename [REN].....	9-8
9.4	File Delete [DEL].....	9-12
Section 10	Utility.....	10-1
10.1	Selecting Utility Mode.....	10-1
10.2	Auxiliary Signal Display [AUX].....	10-4
10.3	External Input/Output Signal Display [I/O].....	10-6
10.4	Current Position Display [POS].....	10-13
10.5	Selecting Work/Tool Coordinate System [TRANS].....	10-16
10.5.1	Finishing Coordinate System Selection [END].....	10-18
10.5.2	Detailed Coordinate Data Display [FULL].....	10-19
10.5.3	Setting Work Coordinate System [WORK].....	10-21
10.5.4	Setting and Canceling of the Tool Coordinate System [TOOL].....	10-23
10.5.5	Search of Coordinate Data [FIND].....	10-25
10.5.6	Coordinate Data Directory Display [DIR].....	10-28
10.6	Working Time Display [WK-TM].....	10-29
10.7	Reproducing the Origin [REORG].....	10-32
10.8	Joint Limit Setting [J-LIM].....	10-34
10.9	Date and Time Setting [DATE].....	10-38
10.10	Version Display [VER].....	10-41
10.11	Servo Encoder Data Display [END].....	10-44
10.12	PLC Monitor [PLC-M].....	10-45
10.13	Zero Position Setting [ZEROP].....	10-47
10.14	Motor Load Display [MOTOR].....	10-48
10.15	Ethernet Status Display [ETHER].....	10-51
10.16	Payload Settings During Manual Guidance [PAYLD].....	10-54
10.17	Initialization to Factory Settings [FCTRY].....	10-58
10.18	RAM Disk Backup [BCKUP].....	10-59
Section 11	Self-Diagnosis.....	11-1
11.1	Classification of Errors.....	11-1
11.2	Display at Error Generation.....	11-1

11.3 Error Display 11-2
11.4 Error Reset..... 11-4
11.5 Error Reset by External Signal 11-5
11.6 Error History Display 11-6
11.7 Compile Error Display 11-8

Section 1 Before Operating Your Robot

1.1 Overview of Operation Functions

Function	Descriptions	Control panel	Teach pendant	External control signal	HOST communication
Main power ON/OFF	Used to turn on and off the main power.	○			
Servo power ON/OFF	Used to turn on and off the servo driver main circuit power.	○	△ (ON only)	○	○
Master mode selection	Used to select either the external automatic mode, internal automatic mode or teaching mode.	○			
Start and stop	Used to start and stop automatic operation.	○	○	○	○
Cycle stop	Used to stop automatic operation. (When 1-cycle operation has finished)	○	○	○	
Feed hold	Used to temporarily stop automatic operation.		○		○
Emergency stop	Used to immediately stop automatic operation.	○	○	○	○
Teaching operation	Used to manually guide the robot by jogging or inching.		○		○
Auxiliary signal operation	Used to operate the pneumatic drive shaft for grip, etc.		○		△
Program editing	Used to teach and edit programs.		○		○
Data editing	Used to teach and edit positional data, coordinate data and load data.		○		○
File operation	Used to copy into RAM or USB, rename, delete, etc.		○		△ (RAM only)
Reset	Used to reset output signals and execution environment.		○	○	○
Date setting	Used to set the system date.		○		
Time setting	Used to set the system date.		○		
Error display	Used to display errors which are yet to be reset.	○	○		○
Error reset	Used to reset errors that have been corrected.		○	○	
Error history display	Used to display a historical list of errors which have been corrected.		○		○

Function	Descriptions	Control panel	Teach pendant	External control signal	HOST communication
Work coordinate system selection	Used to select the work coordinate system.		○		
Tool coordinate system selection	Used to select the tool coordinate system.		○		
Present position monitor	Used to display the present position of the robot in each coordinate system.		○		○
External I/O signal monitor	Used to display the status of digital I/O signals.		○		○
Working time monitor	Used to display turn-on time of power supply and operation time.		○		○
File selection	Used to select a file to be executed.		○	○	○
Movement	Used to move the robot to a taught point.		○		○

○: Operation is possible.

△: Partial operation is possible.

* The TSL3000 does not have a control panel or internal automatic operation function.

1.2 Mode Structure

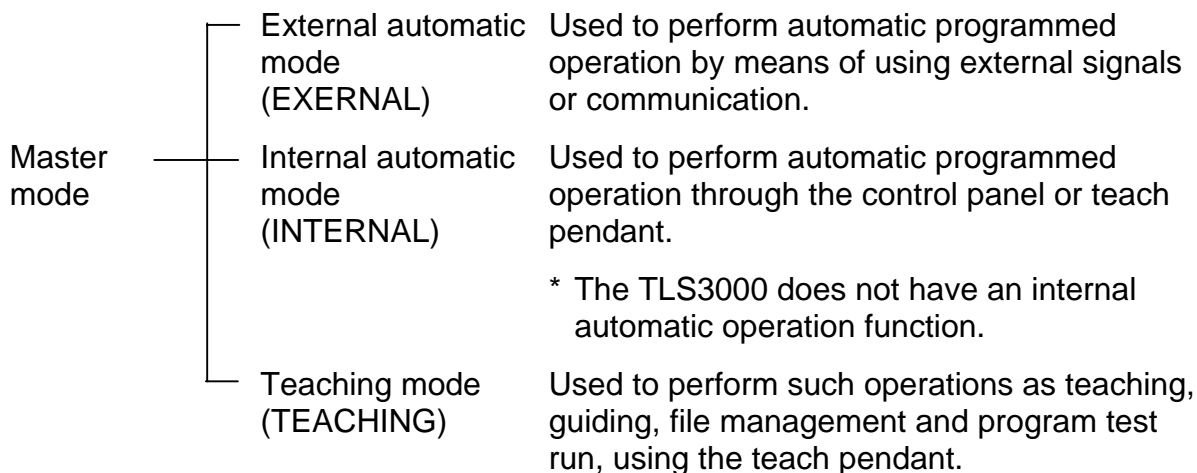

The master mode should be selected by means of the MODE select key equipped on the control panel.

Utility (UTILITY)	Used to perform such operations as coordinate selection, position monitor and signal monitor using the teach pendant, irrespective of the master mode currently selected.
-------------------	---

Error display (ERROR)	Used to display and reset an error using the teach pendant, irrespective of the master mode currently selected.
-----------------------	---

The emergency stop and servo OFF operations are possible, irrespective of the mode currently selected.

1.2.1 External Automatic Mode

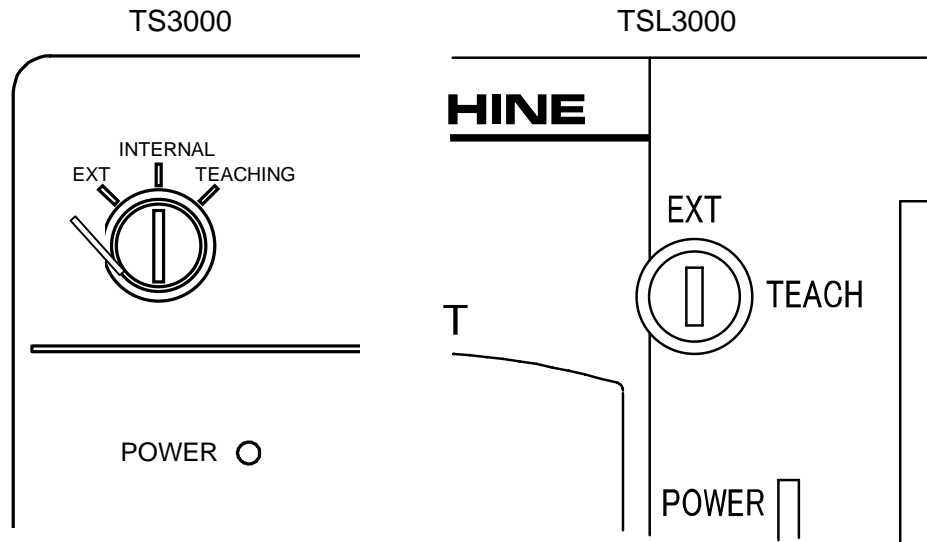

The external automatic mode comes in the three (3) sub modes as shown below. The selection of these modes is carried out using the user parameter.

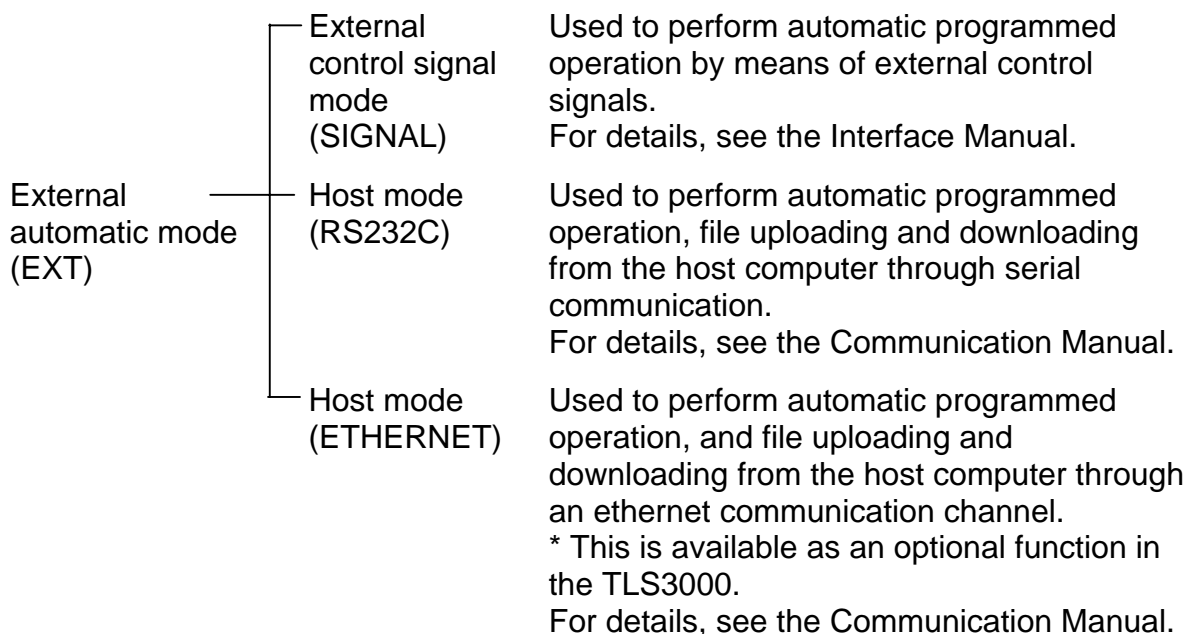

File selection, run mode selection and speed override setting in the internal automatic operation mode or test operation mode are also valid in the external automatic mode.

1.2.2 Internal Automatic Mode (TS3000)

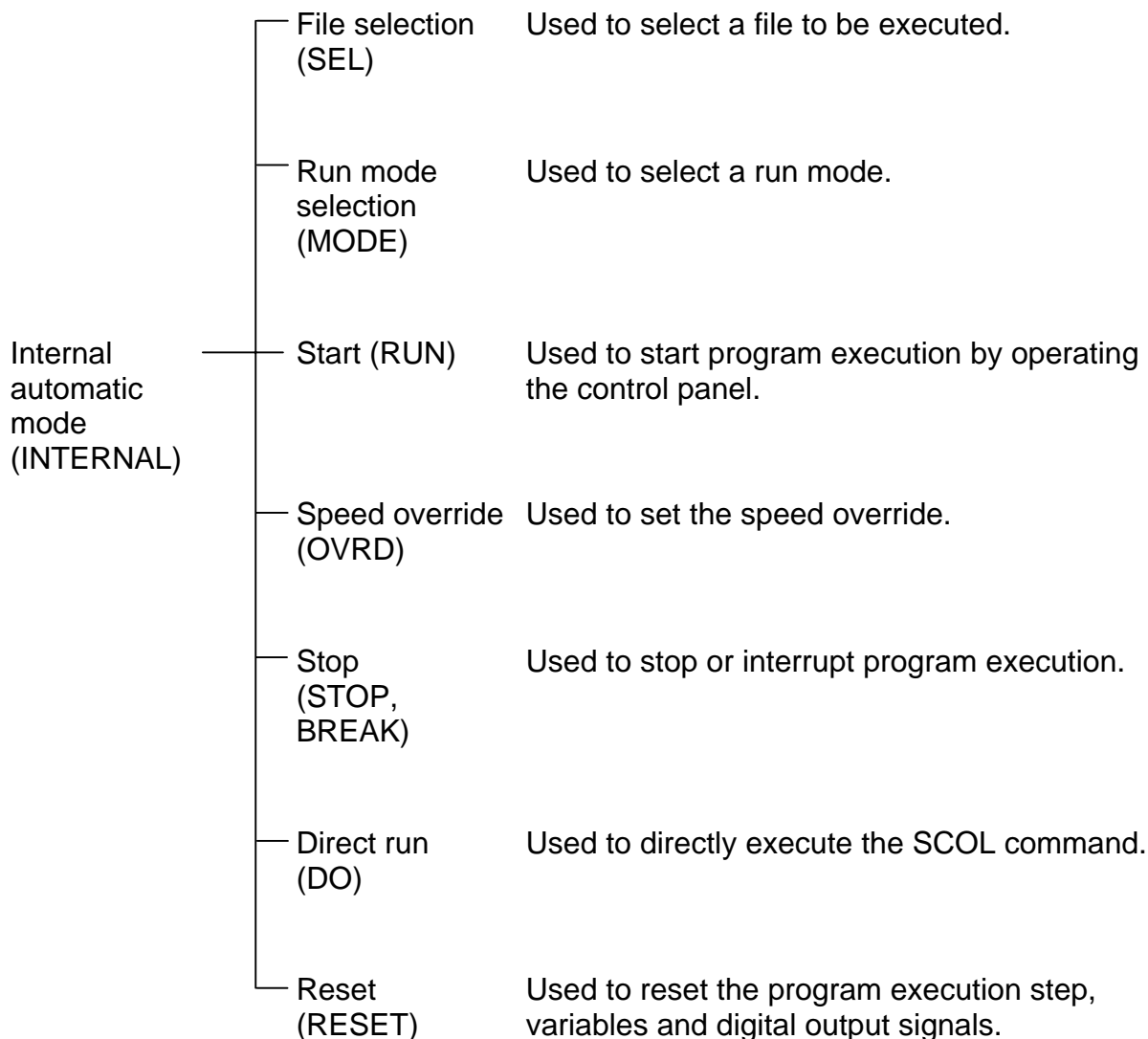

* The TLS3000 does not have an internal automatic operation function.

1.2.3 Teaching Mode (Including Test Operation)

Teaching mode (TEACHING)	—	Program edit (EDIT)	Used to edit programs.
	—	Data edit (DEDIT)	Used to edit various data (position, coordinate and load).
	—	File selection (SEL)	Used to select a file to be executed.
	—	Start (RUN)	Used to execute programmed test operation.
	—	File operation (FILE)	Used to display a file directory, copy, delete and rename files.
	—	Run mode selection (MODE)	Used to select a run mode.
	—	Speed override (OVRD)	Used to set the speed override.
	—	Direct run (DO)	Used to directly execute the SCOL command.
	—	Reset (RESET)	Used to reset the program execution step, variables and digital output signals.
	—	Guide	Used to select the guide mode, guide coordinate and guide speed, then move the end effector by means of the guide keys. This mode is ineffective during test operation.

1.2.4 Edit

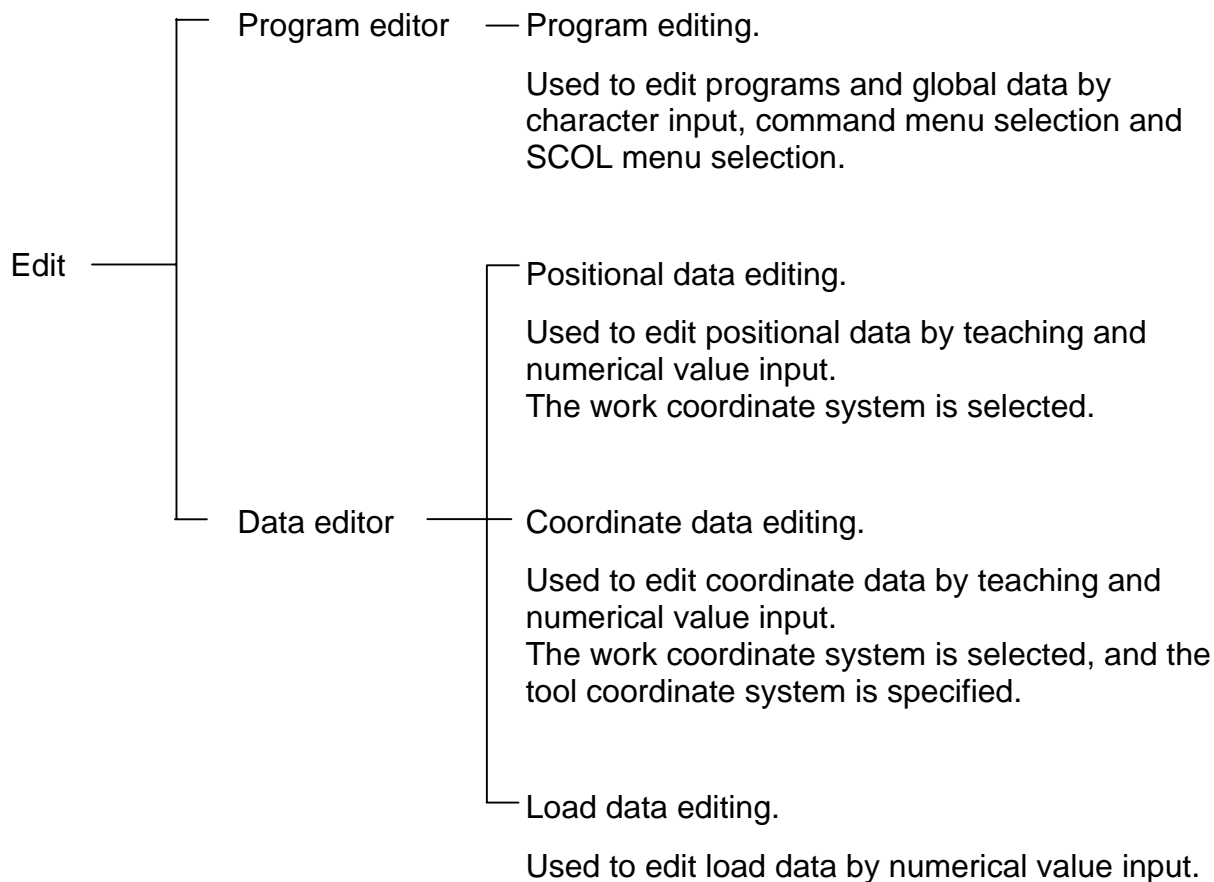

1.3 General Operation

The key seat array on the teach pendant is as shown below.

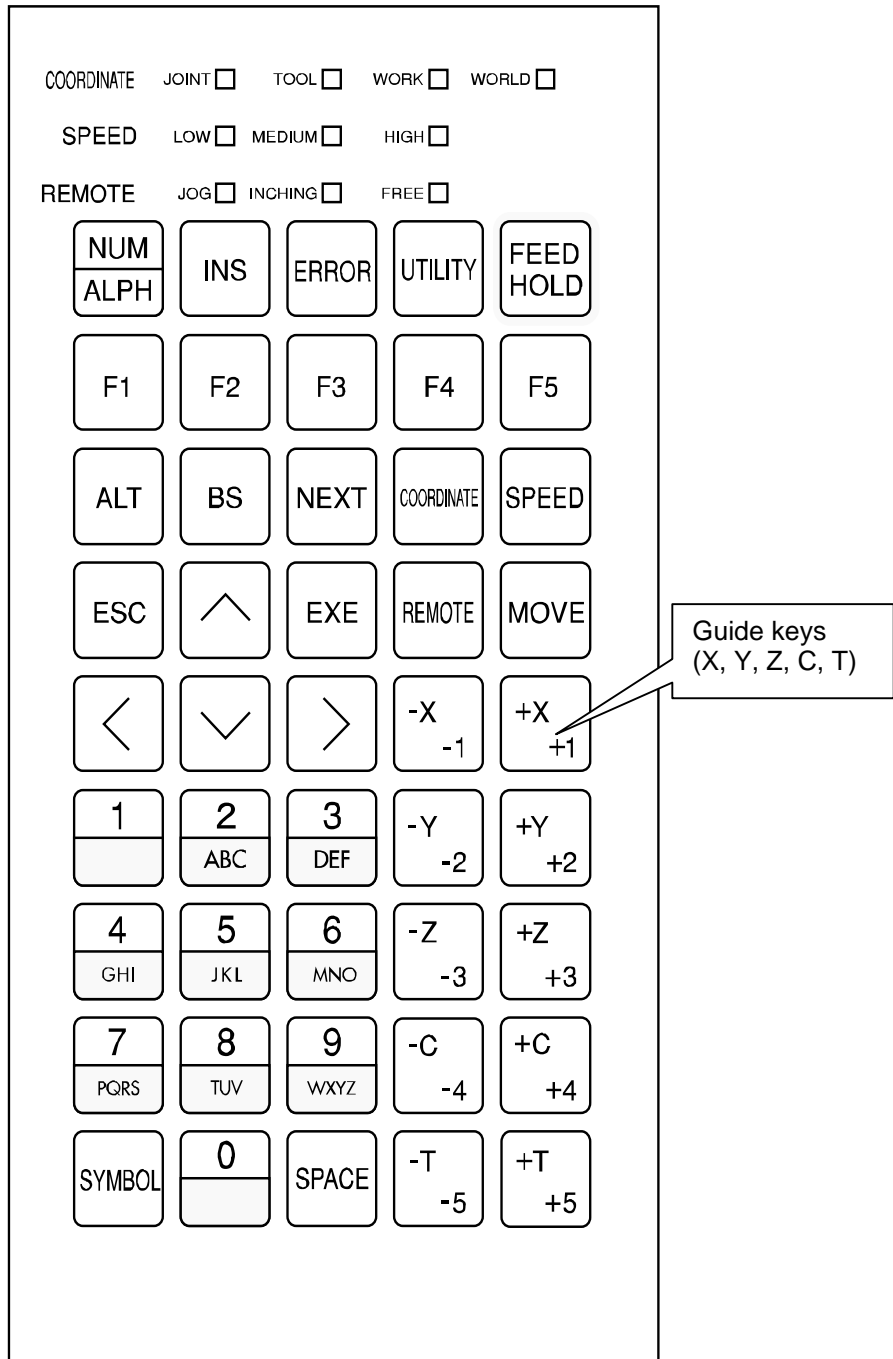

Cursor keys are expressed by in this manual.

1.3.1 Entry of Alphanumeric Characters and Symbols

The alphabet input mode and numeric input mode can be changed over alternately by pressing the

NUM
ALPH

 key. While the numeric input mode is selected, the key lamp is illuminated.

(1) Numeric key input

Select the numeric input (NUM) mode and press a desired key.

Example: When entering number "9":

Key operation	Display			
<table border="1" style="margin: auto; border-collapse: collapse;"> <tr><td style="text-align: center; padding: 2px 10px;">9</td></tr> <tr><td style="text-align: center; padding: 2px 10px;">WXYZ</td></tr> </table>	9	WXYZ	<table border="1" style="margin: auto; border-collapse: collapse;"> <tr><td style="text-align: center; padding: 2px 10px;">9</td></tr> </table>	9
9				
WXYZ				
9				

(2) Alphabet and symbol key input

(2)-1 Alphabet key input

Select the alphabet input (ALPH) mode. Alphabets are classified by group. Press an appropriate key until a desired alphabet is displayed. After the alphabet is displayed, press the EXE key, right cursor key or any other group key, and it is established.

Even if the ALPH mode is selected, pressing the key once calls a number and you can input the number thus called.

Example: When entering alphabet "B":

Key operation	Display			
<table border="1" style="margin: auto; border-collapse: collapse;"> <tr><td style="text-align: center; padding: 2px 10px;">2</td></tr> <tr><td style="text-align: center; padding: 2px 10px;">ABC</td></tr> </table>	2	ABC	<table border="1" style="margin: auto; border-collapse: collapse;"> <tr><td style="text-align: center; padding: 2px 10px;">B</td></tr> </table>	B
2				
ABC				
B				

Press the key three (3) times.
When alphabet "B" is displayed,
press the EXE key.

(2)-2 Symbol (special character) key input

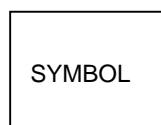

Every time the SYMBOL key is pressed, a special character is displayed.
Though input is possible in both the NUM and ALPH modes,

codes that can be input are grouped according to each mode.

(2)–3 Keys relating to unsettled characters

- ESC Used to cancel an unsettled character or characters.
- BS Used to cancel an unsettled character or characters.
- EXE Used to determine an unsettled character or characters.
- ↑ Used to select a choice before current character string.
- ↓ Used to select a choice after current character string.
- ← Used to cancel an unsettled character or characters.
- Used to determine an unsettled character or characters.

1.3.2 Combined Key Operation

Next page	Press the ALT key and ↓ key.
Previous page	Press the ALT key and ↑ key.
Delete (DEL)	Press the ALT key and BS key.

[Supplementary descriptions]

- * When the cursor is not located on the main display even though it has a plural number of pages, page changeover is basically performed by pressing the ALT key and ↑ key or ALT key and ↓ key. Page changeover is also possible by pressing the single ↑ key or ↓ key. (This is mainly related to the utility monitor display, alarm display and variable display.)

1.3.3 Use of Function Keys

The teach pendant is provided with five (5) function keys (F1 ~ F5) to facilitate command input.

The functions to which F1 ~ F5 keys correspond will change with the mode selected. The command menu corresponding to each function key is displayed at the bottom of the display. Select a desired command by means of the function key.

When five (5) or more commands are available in the menu, mark ">" appears on the right end of the menu line. Press the NEXT key then, and the remaining command menu is displayed.

Example 1: When selecting the "FILE" command:

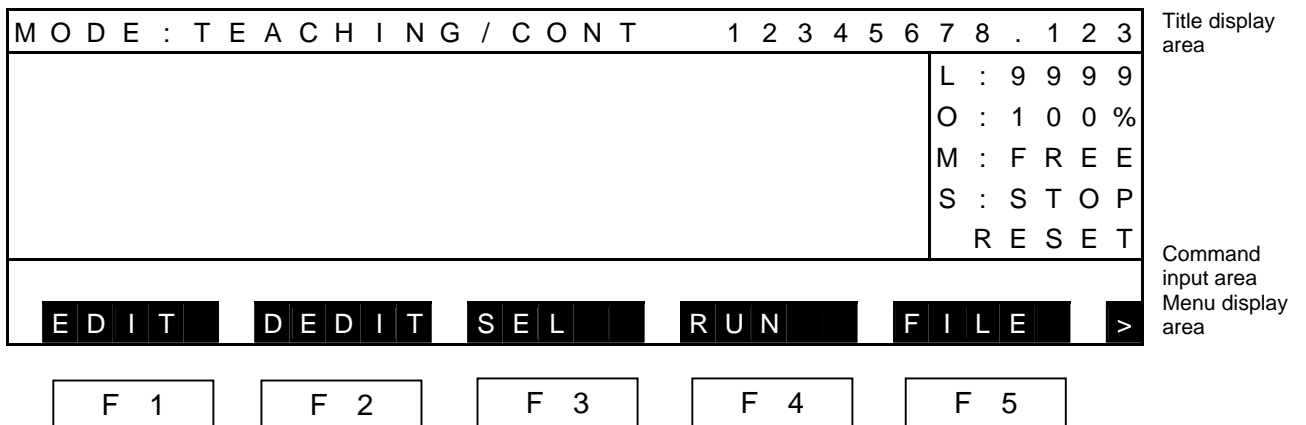

Press the F5 key, and the FILE display is called with new menu displayed. Select a desired function key consecutively.

[Supplementary descriptions]

- * When the function key is pressed in turn, the hierarchy deepens with the relevant new menu displayed. To return to the original hierarchical menu, press the ESC key.
- * In principle, the NEXT key is used to select the NEXT command menu. Unless mark ">" is available on the display, however, it can serve as the NEXT PAGE key.

1.3.4 Repeating an Entry

The repeat function allows entry of repeated operation by pressing the same key continuously.

The following keys are available for the repeat operation.

- Cursor keys (The keys can be moved rapidly by the repeat function.)
- Guide keys (A selected axis moves continuously as long as this key is kept pressed.)
- MOVE key (A selected axis moves continuously as long as this key is kept pressed.)

1.3.5 Correcting Incorrect Entries

Use the BS key to erase any characters which were incorrectly entered.

Example:

(Correct) OVERRIDE: 80

 Press the BS key.

 Press the BS key.

(Incorrect) OVERRIDE: 65__

 ↓

 OVERRIDE: 6__

 ↓

 OVERRIDE: __

Keep pressing the BS key until the incorrect characters are erased. Then try again.

- * In the editor operation, press the BS key while pressing the ALT key, and a character at the cursor position is erased. It functions the same way as the DEL key.



CAUTION

The INS, ↑, ↓, ←, → keys cannot be used at the time of command input.

1.3.6 Canceling an Entry

If you wish to cancel the command you are entering, press the ESC key.

This cancels the command you have entered and allows you to input the next command on the following line.

Should an error message or other such message appear during command input, that command line is canceled.

1.3.7 Use of Wild Cards (*)

You can use wild cards when specifying files with the delete or copy (USB → RAM, RAM → USB) command.

The wild cards are useful to simultaneously specify multiple files. Using the wild cards correctly can save time and increase efficiency when specifying files.

The asterisk wild card (*) is used to represent any character or characters in the file name or extension.

For instance, designation of "A*.*" refers to all files having a name starting with A. All of the following files would apply:

ADATA. BAT
ABC. PAR
AFILE

To use the wild cards effectively, it is recommended to predetermine a rule for assigning a file name and file extension.

1.3.8 Format for Operating Instructions

The following format is used in this manual to explain how to use commands.

Title [Command name]

- | | |
|--------------------------|---|
| (1) Function | Explains the function and application. |
| (2) Operating procedures | Explains the procedures and system response for various operations. |
| (3) Caution | Explains the cautions and restrictions. |
| (4) Related functions | Explains the related functions, if any. |

1.4 Assigning Names

1.4.1 Assigning a File Name

Every file registered in the RAM drive has its own name. This is called the file name. Generally, the file name has the following format.

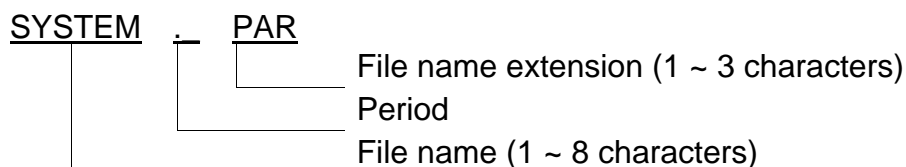

The file name consists of a basic file name (SYSTEM), a file name extension (PAR) and a period (.) discriminating them.

The following characters can be used for the file name and its extension.

- Alphabetic characters : A ~ Z
- Numerals : 0 ~ 9

The file name extension is used to identify the nature (type) of the file. By using different extensions for the same file name, you can express different types of files.

The following extensions are used for this controller.

File name extension	Descriptions
SYS	Signifies a system file.
BAT	Signifies a batch file.
PAR	Signifies a parameter file.
LIB	Signifies a library file.
LOG	Signifies a maintenance file.

The file name extension can be omitted. When this happens, the period is unnecessary.

When specifying a file having a file name extension, you cannot omit that extension. If you do, the controller interprets it as a completely different file.

1.4.2 Assigning a Point Name

When entering positional data for a point, you have to assign a name to that point. This name is used later in the program when teaching the robot where to go.

Generally, the point name has the following format.

PNT100
|
_____ Point name (1 ~ 10 characters)

The following characters can be used for the point name. The first letter of a point name must be an alphabetical character.

Alphabetic characters : A ~ Z
Numerals : 0 ~ 9

Cautions: You cannot use an identifier (reserved word) used for the SCOL language to name a point. For details, see Appendix B of the Robot Language Manual.

The point name entered should consist of up ten (10) characters. If it exceeds this limit, the entry is invalid with an error saying "illegal name" displayed.

If a character other than the alphabetical characters has been entered for the first character of the point name, the entry is invalid with an error saying "illegal name" displayed.

1.4.3 Assigning a Name to Coordinate Data

When entering coordinate data for a the work coordinate system, tool coordinate system or base coordinate system, you have to assign a coordinate name to that data. A coordinate of each coordinate system is specified by the coordinate name.

Generally, the coordinate name has the following format.

<u>TABLE1</u>	Coordinate name (1 ~ 10 characters)

The following characters can be used for the coordinate name. The first letter of a coordinate name must be an alphabetical character.

Alphabetic characters : A ~ Z
Numerals : 0 ~ 9

Cautions: You cannot use an identifier (reserved word) used for the SCOL language to name a point. For details, see Appendix B of the Robot Language Manual.

The coordinate name entered should consist of up ten (10) characters. If it exceeds this limit, the entry is invalid with an error saying "illegal name" displayed.

If a character other than the alphabetical characters has been entered for the first character of the coordinate name, the entry is invalid with an error saying "illegal name" displayed.

1.4.4 Assigning a Name to Load Data

When entering load data, you have to assign a load name to that data. A load in the program is specified by the load name.

Generally, the load name has the following format.

SAMPLE1
|_____ Load name (1 ~ 10 characters)

The following characters can be used for the load name. The first letter of a load name must be an alphabetical character.

Alphabetic characters : A ~ Z
Numerals : 0 ~ 9

Cautions: You cannot use an identifier (reserved word) used for the SCOL language to name a point. For details, see Appendix B of the Robot Language Manual.

The load name entered should consist of up ten (10) characters. If it exceeds this limit, the entry is invalid with an error saying "illegal name" displayed.

If a character other than the alphabetical characters has been entered for the first character of the load name, the entry is invalid with an error saying "illegal name" displayed.

1.5 File

To move the robot, robot language programs, positional data and parameters should be registered beforehand in the controller RAM drive (memory). All of these programs and data are handled on the basis of a file.

1.5.1 Kind of File

The following files are used in the robot system.

- (1) Machine parameter file (MACHINE. PAR)
This file contains parameters used by the maker, such as parameters for robot option setting and axis origin offset.
The user MUST NOT change the values of these parameters.
- (2) Servo parameter file (SERVO. PAR)
This file includes servo-related parameters. The user MUST NOT change the values of these parameters.
- (3) Robot parameter file (ROBOT. PAR)
This file includes parameters specific to the installed robot such as the number of axes, inching amount, and speed limit for test mode. The user MUST NOT change the values of these parameters.
- (4) User parameter file (USER. PAR)
This file includes parameters relating to limit on the working envelope, setting of communication mode, etc., which can be changed by the user.
- (5) Library file (SCOL. LIB)
Some instruction words used for the robot language are contained in this file. The instruction words in the library file are written by the robot language. They include the instruction words for operating the robot hand (OPEN, CLOSE, OPENI, CLOSEI, etc.), and these instruction words can be used only when the library file is present. For further information, see the Robot Language Manual.
- (6) Palletize library file (PALLET. LIB)
This library file is required when using palletize commands (INITPLT, MOVEPLT) in the program created by the robot language. For further information, see the Robot Language Manual.

- (7) Automatic start file (AUTOSTR. BAT)
A kind of batch file, it is automatically executed when the controller power is turned on.
- (8) Program file
A file stating the robot motions. It saves positional data and programs created by the robot language. Each file corresponds to one job.
- (9) External select file (EXTRNSEL. PAR)
This file is used when you select a program you wish to execute by means of an input signal to the controller. It contains the program names which can be selected by means of the input signal.
- (10) Ethernet parameter file (ETHERNET. PAR)
This file includes Ethernet-related parameters.
- (11) Conveyor parameter file (CONVEYOR. PAR)
This file includes the conveyor-related parameters.

The following files are mandatory in the RAM drive.

MACHINE. PAR
SERVO. PAR
ROBOT. PAR
USER. PAR

The following files can be omitted unless necessary.

AUTOSTR. BAT
SCOL. LIB
PALLET. LIB
EXTRNSEL. PAR
ETHERNET. PAR
CONVEYOR. PAR

1.5.2 Batch File

The controller is provided with a function executing a series of commands in the pack, which is called the "batch processing." To execute the batch processing, commands should be written in the file in the order of execution. This file is generally referred to as the "batch file." The batch file extension is ".BAT".

A file executed automatically just after the controller power is turned on is called the "automatic start file." The name of this file is "AUTOSTR. BAT."

The automatic start file can be used for file selection in the external automatic mode. For the file editing operation, see Para. 4.5.

Example: When executing files to be executed just after the power ON in the external automatic mode:

```
File names : AUTOSTR. BAT
            SELECT PRO1
```

Save the above automatic start files in the controller RAM drive beforehand. When the controller has started up after its power was turned on, the file PRO1 is selected as the file for execution.

The commands which are effective in the automatic start file are SELECT, OVRD, DATE, TIME, and SVON.

- Notes:
- SVON is a command that is effective in internal automatic (INTERNAL, only for TS3000) and external automatic (EXT) modes.
 - In manual (TEACHING) mode, "CAN NOT EXECUTE!" is displayed on the teach pendant.

1.5.3 Backup

Though programs using the robot language, positional data, changed user parameters, etc., are saved in the RAM drive, it is recommended to back them up to prepare for the worst. For this purpose, connect the serial port HOST and personal computer and use our personal computer support software. This is also applicable when loading the programs and data in the RAM drive.

For the personal computer support software refer to the separate manual.

Section 2 Basic Operation

2.1 Basic Operating Procedures

The following flow chart shows the basic operating procedures for automatic operation. It covers all operations from turning on the main power to turning off the main power.

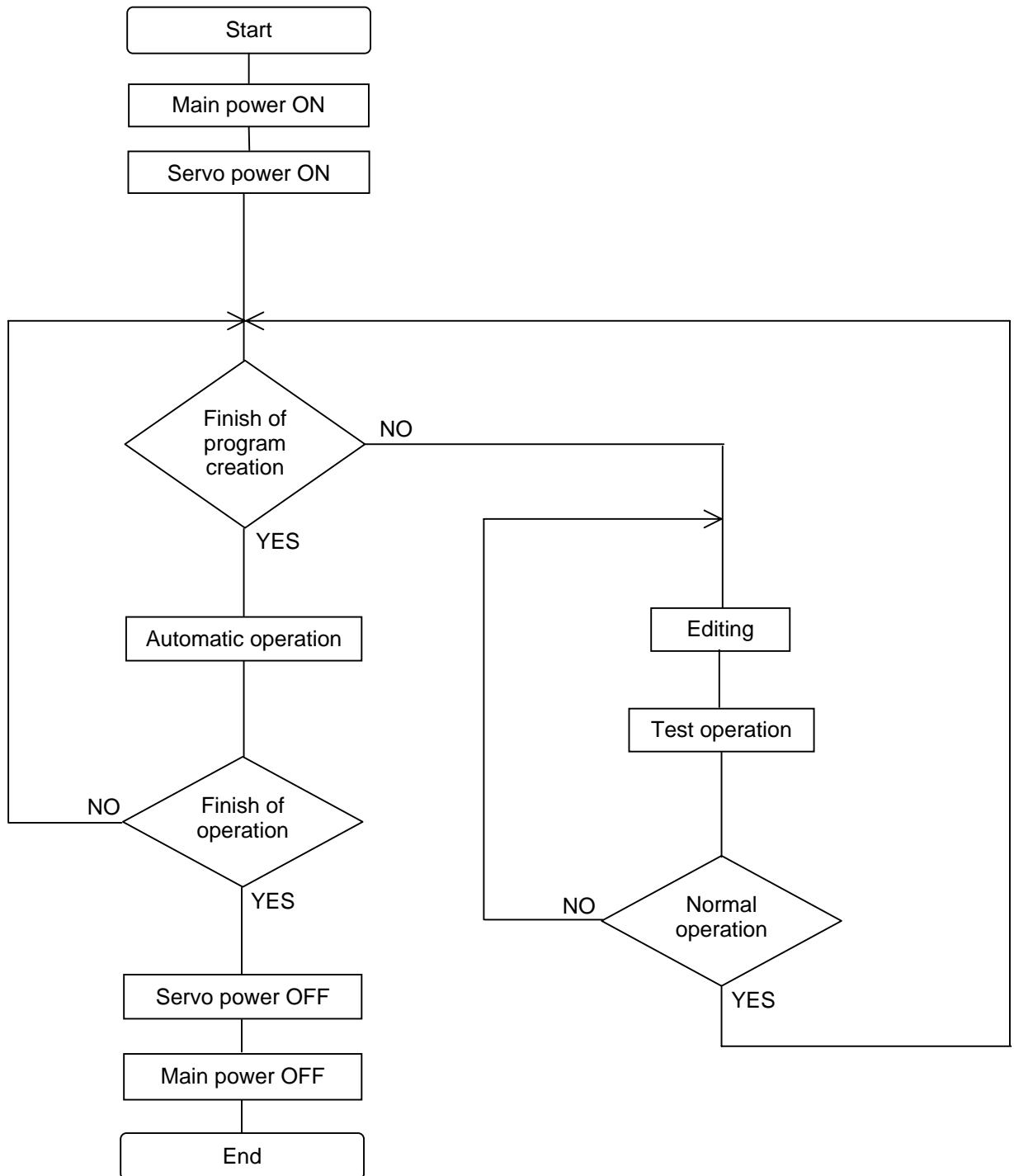

2.2 Main Power and Servo Power of TS3000 Controller

2.2.1 Control Panel (TS3000)

The control panel of TS3000 is shown below.

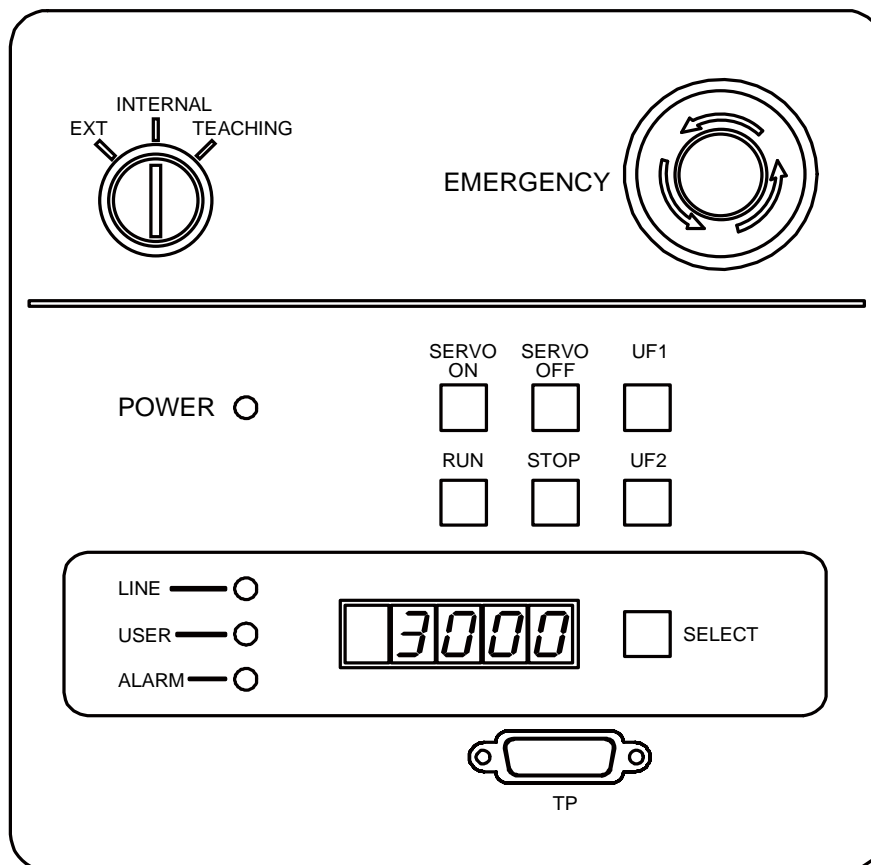

- | | | |
|--------------------------|-------|--|
| (1) Key switch | : | Used to select the operation master mode. |
| (2) SERVO ON switch/LED | : | Used to turn on the servo power. |
| (3) SERVO OFF switch/LED | : | Used to turn off the servo power |
| (4) RUN switch/LED | : | Used to start the internal automatic mode operation. |
| (5) STOP switch/LED | : | Used to stop the operation after the active block has been executed. |
| (6) SELECT switch/LED | : | Every time this switch is pressed, content shown on the display changes. |
| | LINE: | No. of program execution steps. |
| | USER: | A value set by PLCDATAW1 of the program. |

ALARM: Alarm number currently generated in the controller.

If two (2) or more alarms have occurred, such alarm numbers are displayed at intervals of two (2) seconds.

When an alarm occurs, this switch flashes.

- (6) UF1, UF2 switches/LEDs : User function switches.
This switch input can be referred to by DIN and the lamp output by DOUT.
- (7) EMERGENCY : EMERGENCY stop pushbutton switch.

2.2.2 Turning ON the Main Power (TS3000)



CAUTION

If an abnormality has generated or the POWER LED lamp on the control panel remains off after the main power switch of the controller was turned on, turn off the main power immediately and confirm the wiring. Otherwise, you will be struck by an electric shock or a fire will break out.

When the power is turned on, the controller enters a program reset status.

- (1) Function
 - The controller is started up by the system programs saved in the flash memory.
- (2) Procedures
 - (a) Step 1: Turning on the main power.
 - Set the MAIN POWER switch on the controller to ON position, and the POWER LED and SERVO OFF LED are illuminated.
 - The controller starts initializing the system. The STOP LED on the control panel is illuminated and the system is ready for an operation with the initial display of a selected mode called on the teach pendant.

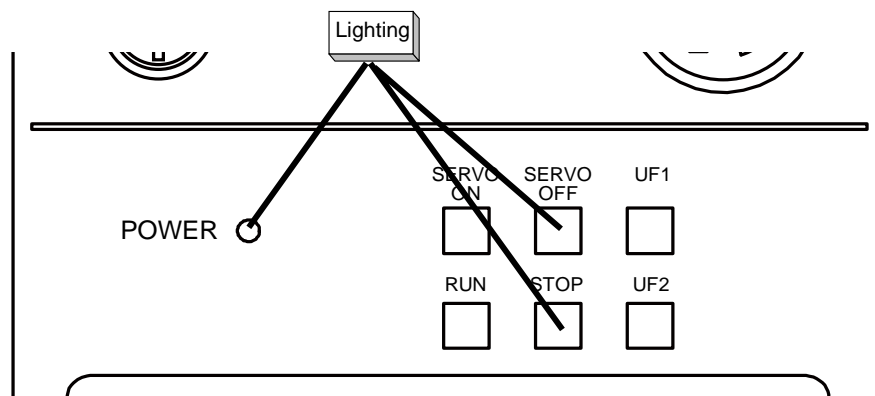

(3) Cautions

- The following reserved files are required in the RAM drive.

MACHINE. PAR	SCOL. LIB *	EXTRNSEL. PAR*
SERVO. PAR	AUTOSTR. BAT *	ETHERNET. PAR*
ROBOT. PAR	PALLET. LIB *	CONVEYOR. PAR*
USER. PAR		

- The asterisk (*)-marked files are not absolutely necessary to run the system. However, an error occurs when you try to execute a function dependent on a missing file.

2.2.3 Turning ON the Servo Power



CAUTION

- If the robot moves abnormally at servo power ON, immediately press the EMERGENCY stop pushbutton switch to turn the servo power off.
- If you enters the dangerous area of the robot, turn off the servo power beforehand.

(1) Function

Turns on the main circuit power of the servo driver. The servo-controlled axes are locked and any brake is released.

(2) Procedures

(a) Step 1: Turning on the servo power.

Press the SERVO ON switch on the control panel or teach pendant while holding the enable switch (position 1) on the teach pendant. When the main circuit power of the servo driver is turned on, the SERVO ON LED on the control panel is illuminated with the SERVO OFF LED turned off. The SERVO ON LED on the teach pendant is also illuminated.

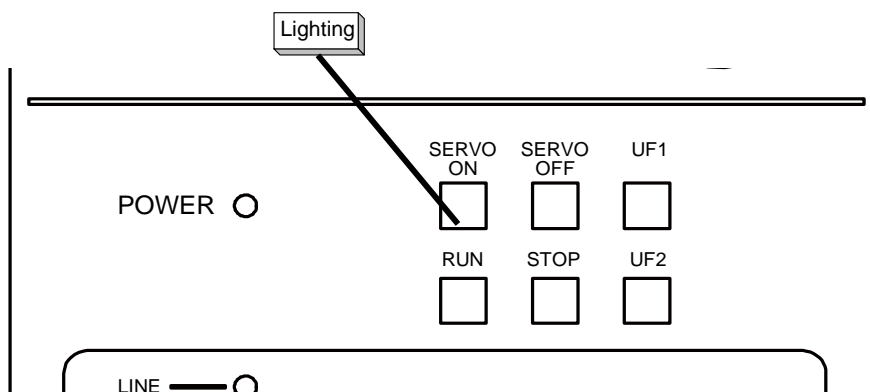

(3) Cautions

- While the EMERGENCY stop switch is pressed, the servo power will not turn on. Be sure to cancel an emergency stop before turning on the servo power.
- The servo power can be turned on through the teach pendant only when the teaching mode is selected.
- The servo power does not turn on by an external control signal when the contacts for the emergency stop and servo off external signals are open and when the control panel teach pendant connector is disconnected.
- The teach pendant connector (or dummy connector) should be connected to the TP connector of the control panel. For more information, see the Interface Manual.
- Although the servo power can be turned on continuously up to the second servo unit, a time interval must be set before turning on a third servo unit.

2.2.4 Turning OFF the Servo Power (TS3000)

- (1) Function

Turns off the main circuit power of the servo driver. The servo-controlled axes are set free and any brake is activated.
- (2) Procedures
 - (a) Step 1: Turning off the servo power.

Press the SERVO OFF switch on the control panel.

When the main circuit power of the servo driver has turned off, the SERVO OFF LED equipped on the control panel is illuminated with the SERVO ON LED turned off. The SERVO ON LED on the teach pendant also goes out.

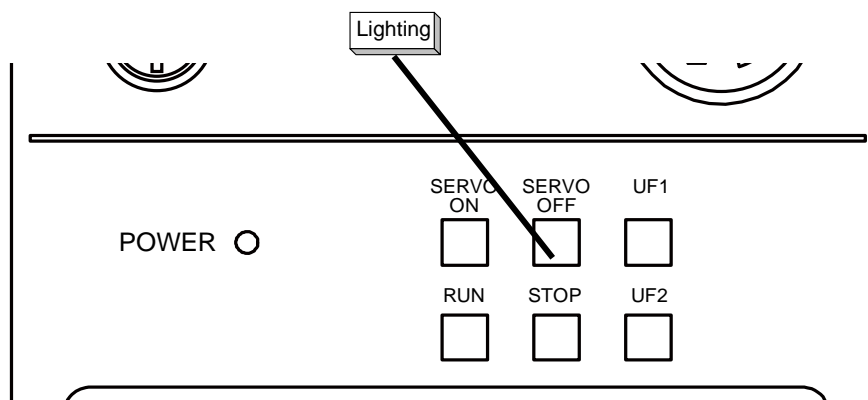

- (3) Cautions
 - DO NOT turn off the servo power while the robot is operating. When you have to stop the robot urgently, press the EMERGENCY stop switch instead.
 - Before you have to enter the robot working area, or when no operator is to be present at other than automatic operation, turn off the servo power for safety reasons.
 - For the servo power OFF by external control signal, see the Interface Manual.

2.2.5 Turning OFF the Main Power (TS3000)

- (1) Function
Turns off the main power and stops controller processing.
- (2) Procedures
 - (a) Step 1: Turning off the main power.
Set the MAIN POWER switch on the controller to the OFF position, and the "POWER" LED on the control panel goes out.

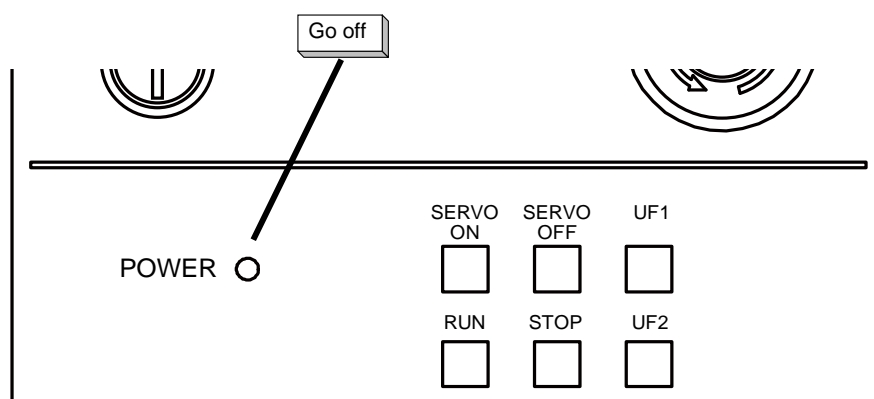

- (3) Cautions
 - DO NOT turn off the main power while the servo power is on or during file operation or any other processing.
 - Before turning off the main power, make sure that the servo power is off and that no active processing is present.

2.3 Main Power and Servo Power of TSL3000 Controller

2.3.1 Controller Front Panel (TSL3000)

The TSL3000 front panel is shown below.

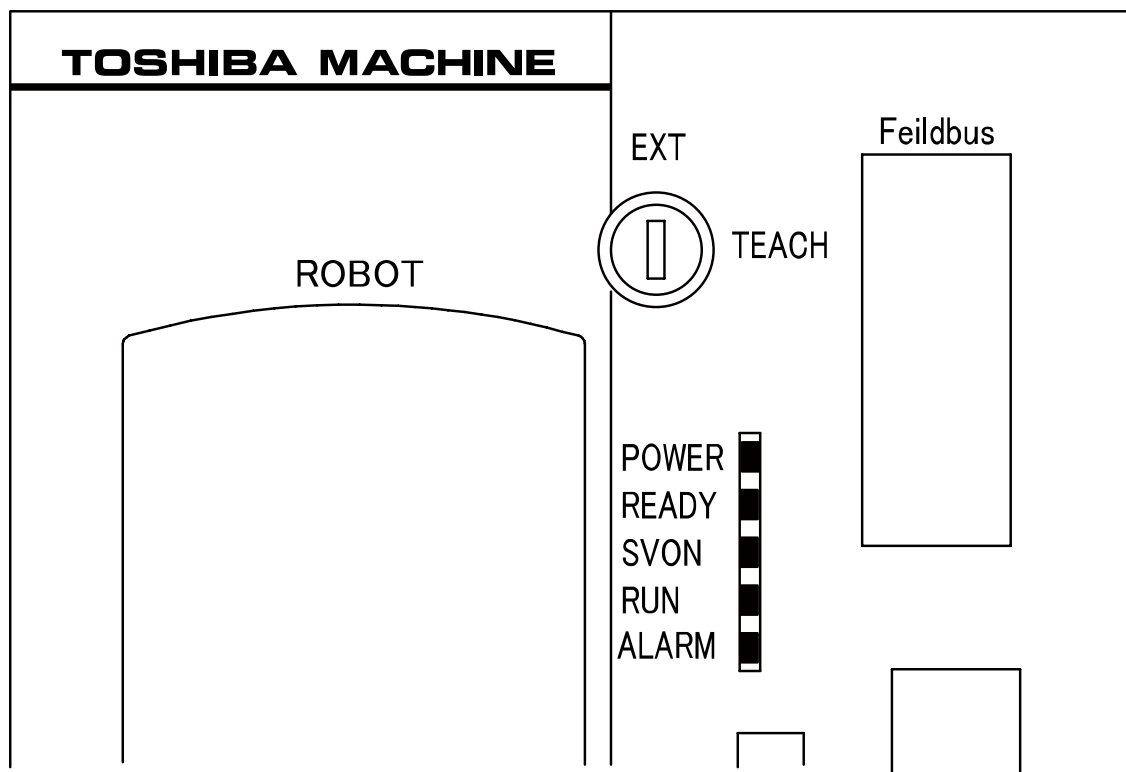

- | | |
|---------------|--|
| (1) Keyswitch | : Used to select operation master mode. |
| (2) POWER | : Indicates that the main power is turned on. |
| (3) READY | : Indicates that the system was started properly after the main power was turned on. |
| (4) SVON | : Indicates that the servo power is turned on. |
| (5) RUN | : Turns on when a program is being executed. |
| (6) ALARM | : Indicates that an alarm has occurred. |

2.3.2 Turning ON the Main Power



CAUTION

If anything abnormal occurs when turning on the main power switch of the controller or if the POWER LED on the control panel does not turn on, immediately turn off the power, and check the cables. Failure to turn off the power can result in an electric shock or fire.

Whenever the power is turned on, programs in the controller are reset.

- (1) Power switch

The TSL3000 does not include a no-fuse breaker in the controller. This must be provided by the customer. For details, see the Interface Manual.
- (2) Procedures
 - (a) Step 1: Turning ON the main power

Set the no-fuse breaker installed outside the controller to the ON side. The controller front panel POWER LED turns on.

The controller starts system initialization, and the control panel READY LED turns on. The initial screen of the mode selected by the teaching pendant is displayed to indicate that operation is possible.

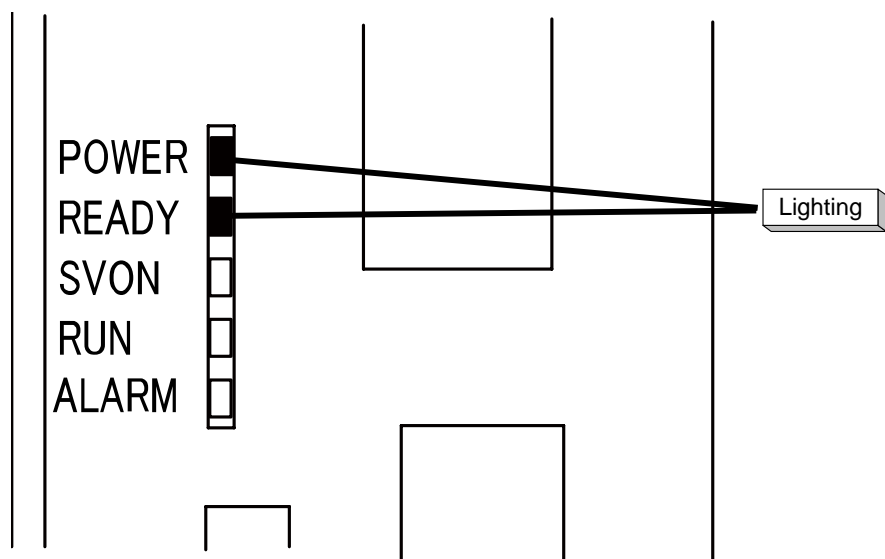

(3) Cautions

- The reserved files below are required in the RAM drive.

MACHINE .PAR	SCOL	.LIB	*	EXTRNSEL.PAR*
SERVO .PAR	AUTOSTR.BAT		*	ETHERNET.PAR*
ROBOT .PAR	PALLET	.LIB	*	CONVEYOR.PAR*
USER .PAR				

- The files marked by an asterisk (*) are not required. If a function that requires those files is executed, an error will occur.

2.3.3 Turning ON the Servo Power



CAUTION

- If the robot performs an abnormal operation when turning on the servo power, immediately press the emergency stop switch to turn off the servo power.
- Be sure to always turn off the servo power when entering into the robot hazard zone.

(1) Function

Set the main circuit power of the servo driver to “ON”. The servo control axis is set to servo lock, and if there is a brake, the brake is released.

(2) Procedures

(a) Step 1: Turning ON the servo power

In TEACH mode, hold the enable switch of the teach pendant, and press the SERVO ON switch. In EXT mode, the external signal (SVON) is set to ON.

When the main circuit power of the servo driver is set to ON, the SVON LED on the controller front panel turns on. The SERVO ON LED for the servo on the teach pendant also turns on.

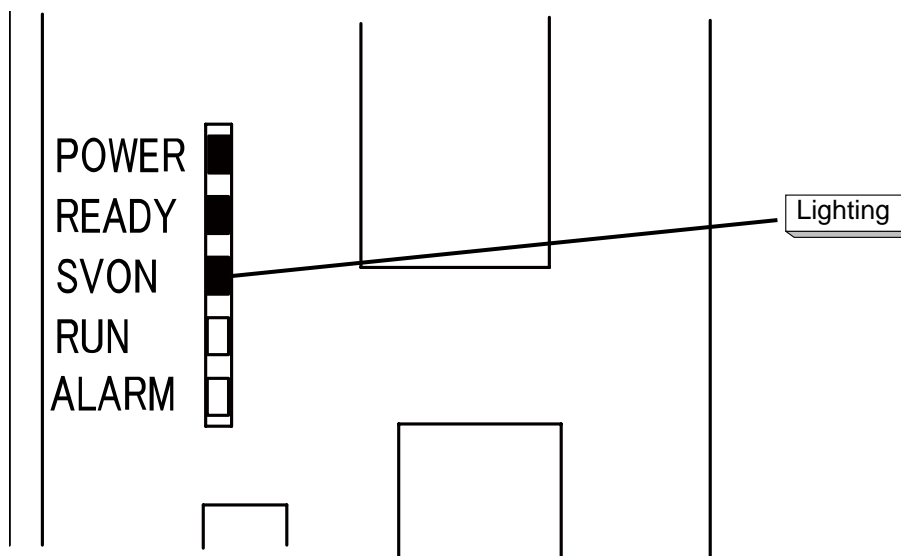

(3) Cautions

- The servo power cannot be turned ON when the emergency stop switch is in the pressed state. Be sure to reset the emergency stop switch before performing operation.
- The servo power can be turned ON by the teach pendant in manual mode only.
- The servo power does not turn on using an external control signal when the emergency stop signal (external signal) and servo OFF signal contacts are open and when nothing is connected to the TP connector of the control panel.
- Connect the teach pendant or a dummy connector to the TP connector. For details, see the Interface Manual.
- The servo can be turned ON up to two times in succession, you must wait a certain amount of time before it is turned ON a third time.

2.3.4 Turning OFF the Servo Power

(1) Function

Set the main circuit power of the servo driver to "OFF".

The servo control axis is set to servo free, and if there is a brake, the brake is applied.

(2) Procedures

(a) Step 1: Turning OFF the servo power

In TEACH mode, release the enable switch of the teach pendant. In EXT mode, the external signal (SVOFF) is set to OFF.

The SVON LED on the controller front panel turns off. The SERVO ON LED on the teach pendant also turns off.

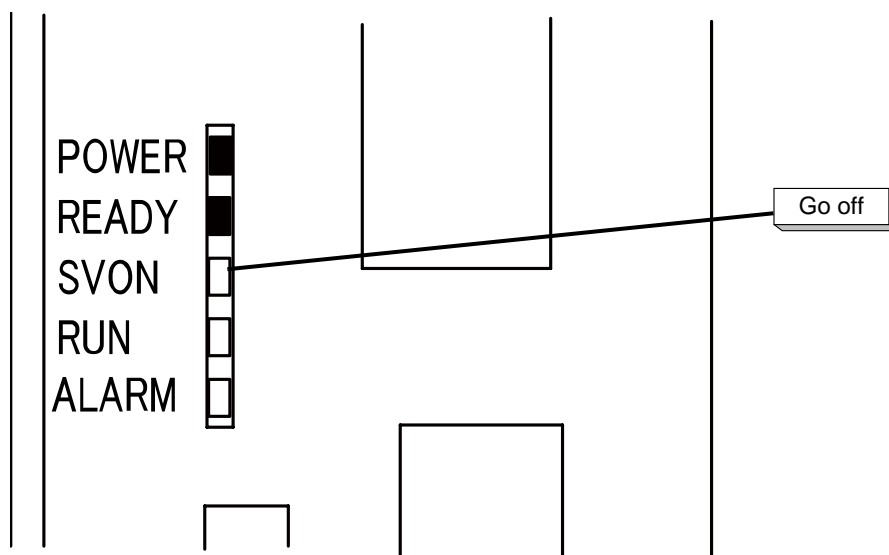

(3) Cautions

- Never turn off the servo power during robot operation. To stop the robot immediately, press the emergency stop switch.
- Before entering into the robot movable area or if operators are not present for operations besides automatic operation, be sure to set the servo power to OFF to ensure safety.
- For details on turning OFF the servo power using an external control signal, see the Interface Manual.

2.3.5 Turning OFF the Main Power

(1) Function

Set the main power to the OFF to stop the controller processes.

(2) Procedures

(a) Step 1: Turning OFF the main power

Set the no-fuse breaker installed outside the controller to the OFF side.

The controller front panel POWER LED and READY LED turn off.

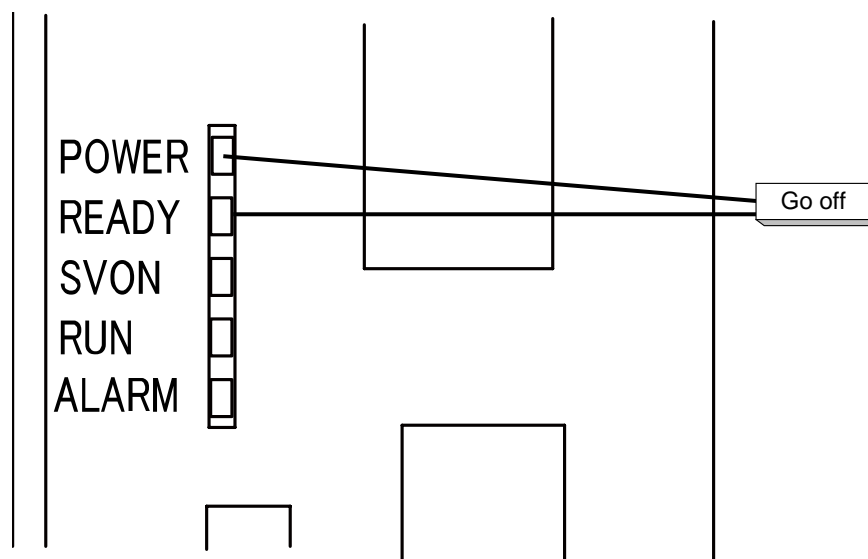

(3) Cautions

- Do not set the main power to OFF while the servo power is ON or during file operations or other processes.
- Before turning OFF the main power, be sure to turn OFF the servo power and check that no processes are running.

Section 3 Teaching Operation

3.1 Selecting the Teaching Mode

(1) Function

Changes over to the teaching mode in which the robot is manually guided, points are taught, files are operated and the system is controlled.

(2) Procedures

(a) Step 1: Teaching mode selection.

Change over the master mode select [MODE] switch on the control panel to select "TEACHING."

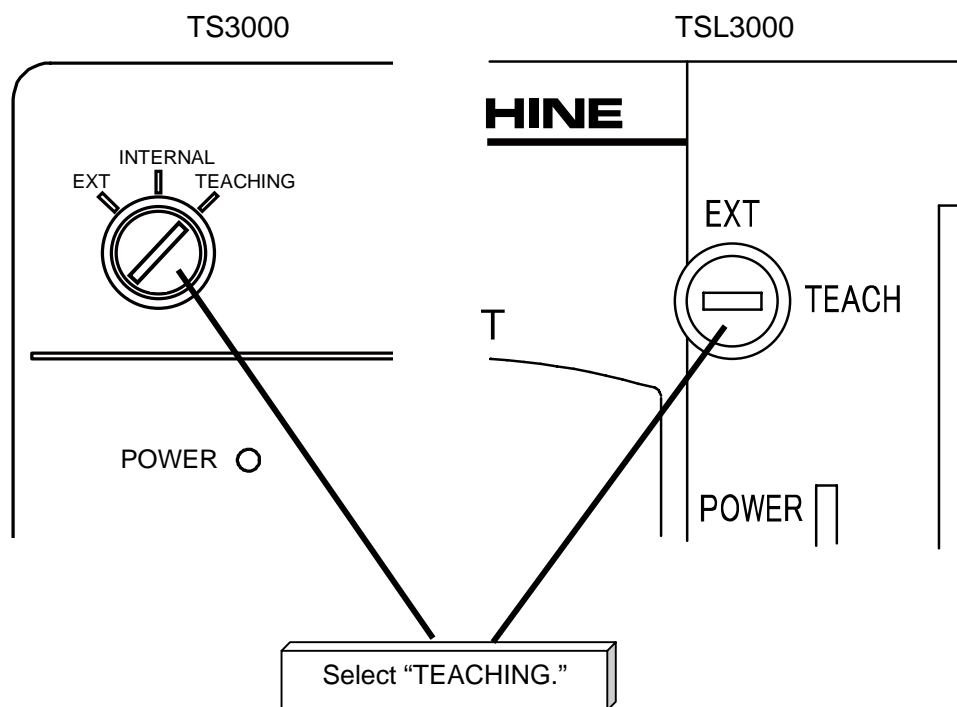

When the teaching mode is selected, the following display appears.

M O D E : T E A C H I N G / C O N T	
	L : O : 2 0 % M : F R E E S : S T O P R E S E T
E D I T	D E D I T S E L F I L E >

- The function key menu is displayed on the bottom of the display. The menu shown in the teaching mode is as follows:

[EDIT]	Program editing
[DEDIT]	Data editing
[SEL]	Selection of program to be executed
[RUN]	Test operation start
[FILE]	File mode
[MODE]	Run mode selection
[OVRD]	Override setting
[RESET]	Reset
[DO]	Direct execution
[WATCH]	Variable monitor
[LDISP]	Display of line to be executed

- (3) Caution
[LDISP] is not displayed during execution of STEP.

3.2 Guidance Coordinates

(1) Function

Selects a coordinate system in which the robot is guided, from among the joint, tool, work and world coordinate systems. Guide will be made possible along the selected coordinate system.

(2) Procedures

(a) Step 1: Selection of tool or work coordinate system.

Select the work or tool coordinate system used for [TRANS] of the utility function. For details, see Section 12.

When using the joint or world coordinate system, this operation is unnecessary.

(b) Step 2: Coordinate selection.

Each time the COORDINATE key on the teach pendant is pressed, JOINT, TOOL, WORK, and WORLD are selected in turn with the appropriate LED illuminated. The initial setting is JOINT.

(3) Cautions

- For each coordinate system of the robot, see the Language Manual.
- Unless a tool, base or work coordinate has been taught to the robot, the tool coordinate system matches the flange face, and the work and world coordinate systems coincide with the base coordinate system.
- When using the tool or work coordinate system, make sure what tool and work have been selected.

3.3 Guide Mode

The guide mode comes in three (3) modes; JOG, INCHING and FREE.

- In the JOG mode, while the guide key is being pressed in the direction of any axis, the robot moves in the selected coordinate system at a selected speed and in the axis direction. This mode is useful for rough positioning of the robot to get it near the target position.
- In the INCHING mode, every time the guide key is pressed in the direction of any axis, the robot moves in the selected coordinate system by the amount of selected movement in the axis direction. This mode is useful for fine positioning of the robot from near the target position to the target position.
- In the FREE mode, any axis's servo lock is cancelled to move the robot by hand. This mode is useful for delicate positioning of the robot to bring the robot near the workpiece or other object.

(1) Function

Selects the manual guide mode.

(2) Procedures

(a) Step 1: Teaching mode selection.

Press the MODE switch on the control panel to select "TEACHING."

(b) Step 2: Guide mode selection.

Each time the REMOTE key on the teach pendant is pressed, JOG, INCHING and FREE are selected in turn with the appropriate LED illuminated. The initial setting is JOG.

(3) Caution

When the guide mode is changed from FREE to JOG or INCHING, servo lock is effected on all axes.

3.4 Guide Speed

(1) Function

Selects the speed or travel distance for manual guide.

When the JOG mode is selected, speed selection becomes effective. When the INCHING mode is selected, travel distance selection prevails.

Select the speed or travel distance according to the distance to the target position.

(2) Procedures

(a) Step 1: Guide speed selection.

Each time the SPEED key on the teach pendant is pressed, LOW, MEDIUM and HIGH are selected in turn with the appropriate LED illuminated. The initial setting is LOW.

3.5 Guidance



CAUTION

- When guiding the robot manually, **DO NOT** enter the dangerous area of the robot.
- If the robot moves abnormally, immediately effect an emergency stop.

(1) Function

While the JOG or INCHING mode is selected, the robot can be moved in a desired direction by pressing the appropriate guide key.

(2) Procedures

(a) Step 1: Teaching mode selection.

Press the MODE switch on the control panel to select "TEACHING."

(b) Step 2: Setting of guidance conditions.

Set the guidance conditions (guide coordinates, guide mode, and guide speed) as necessary.

The guide coordinates, guide mode, and guide speed can be selected in any order. Select them before pressing the guide key.

(c) Step 3: Guidance.

Press the guide key (indicating axis and direction) for a desired axis with the servo being turned on.

Then the robot moves as directed in the specified coordinate system.

(3) Cautions

- The guide key is effective only when it is pressed with the servo being turned on.
- The state when the enable switch is pressed two positions is the same as when it is released.
- The robot does not move even if only the guide key is pressed in order to prevent accidents.
- When the FREE mode is selected, the guide key does not select the direction of axes but cancels each axis servo lock.

3.6 Servo Free

(1) Function

In the FREE mode, it is possible to cancel a servo lock of any axis to make it servo-free. The axis thus set servo-free can be moved by hand. This mode is useful for delicate positioning of the robot to bring the robot near the workpiece or other object.

(2) Procedures

(a) Step 1: Teaching mode selection.

Press the MODE switch on the control panel to select "TEACHING."

(b) Step 2: Guide mode selection.

Press the REMOTE key on the teach pendant to select "FREE". Make sure that the FREE LED is illuminated.

(c) Step 3: Servo lock cancel.

Press the minus (–) key for an axis whose servo locked condition is to be canceled with the servo being turned on.

(d) Step 4: Guidance.

The axis whose servo locked condition was canceled enters a servo-free status. Now the robot can be guided by hand.

(e) Step 5: Servo lock.

Press the plus (+) key for the axis whose servo locked condition is canceled with the servo being turned on. Then the servo-free axis enters a servo-locked status.

(3) Cautions

- When you select the RUN mode, direct execution mode, internal automatic mode or external automatic mode while the servo lock is canceled, servo lock is effected on all axes.
- The guide keys are operative only when they are pressed with the servo being turned on.
- When operating the robot manually in a servo free status, canceling the servo free guidance cannot be completed during the axis interference feed hold.
- You can cancel the servo free status during the error history display.

Section 4 Program Editing

4.1 Starting Up the Program Editor [EDIT]

- (1) Function
Starts up the program editor to edit a program.
- (2) Procedures
 - (a) Step 1: Mode selection.
Change over the MODE switch equipped on the control panel to select "TEACHING."

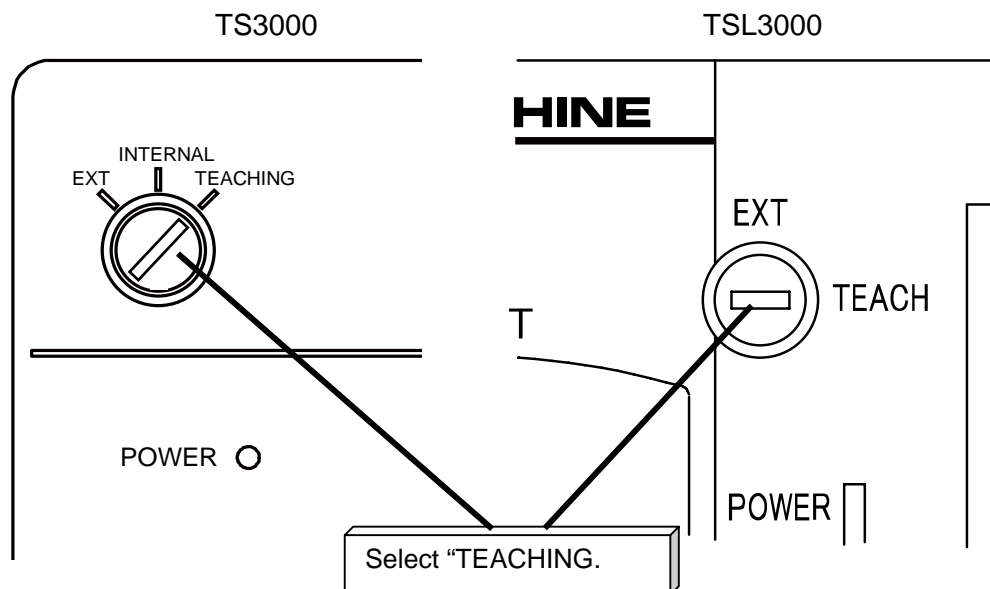

- (b) Step 2: Menu selection.
Keep pressing the NEXT key until the EDIT menu appears on the display.
Then press the function key corresponding to [EDIT].

MODE : T E A C H I N G / C O N T										1	2	3	4	5	6	7	8	.	1	2	3																																						
										L : 9 9 9 9																																																	
										O : 1 0 0 %																																																	
										M : F R E E																																																	
										S : S T O P																																																	
										R E S E T																																																	
E D I T										D E D I T										S E L										R U N										F I L E										>									

(c) Step 3: File selection.

Select the file name by means of the up and down cursor keys.

To create a new file, press [NEW].

```
EDIT ( 0 0 1 / 2 5 6 )
* ABCD 1 2 3 4 . 5 6 7 1 2 3 4 5 6 Feb - 1 2 - 2 0 0 8
FILE 0 0 0 2 . 0 1 2 1 2 3 4 5 6 Feb - 1 3 - 2 0 0 8
FILE 0 0 0 3 . 0 1 2 1 2 3 4 5 6 Feb - 1 4 - 2 0 0 8
FILE 0 0 0 4 . 0 1 2 1 2 3 4 5 6 Feb - 1 5 - 2 0 0 8
FILE 0 0 0 5 . 0 1 2 1 2 3 4 5 6 Feb - 1 6 - 2 0 0 8
: _
NAME TIME NEW
```

Unless the F3 [NEW] key was pressed:

Press the EXE key, and the selected file name is displayed on the command line. It is also possible to rename the file. For this purpose, return the cursor by means of the BS key and enter a desired file name.

```
EDIT ( 0 0 1 / 2 5 6 )
* ABCD 1 2 3 4 . 5 6 7 1 2 3 4 5 6 Feb - 1 2 - 2 0 0 8
FILE 0 0 0 2 . 0 1 2 1 2 3 4 5 6 Feb - 1 3 - 2 0 0 8
FILE 0 0 0 3 . 0 1 2 1 2 3 4 5 6 Feb - 1 4 - 2 0 0 8
FILE 0 0 0 4 . 0 1 2 1 2 3 4 5 6 Feb - 1 5 - 2 0 0 8
FILE 0 0 0 5 . 0 1 2 1 2 3 4 5 6 Feb - 1 6 - 2 0 0 8
: FILE 0 0 0 2 . 0 1 2 _
NAME TIME NEW
```

(d) Step 4: Check the file name to be edited.

Check for the name of a file to be edited to make sure that you are dealing with the right file. If OK, press the EXE key. Unless the specified file is present in the RAM drive, you can create a new file.

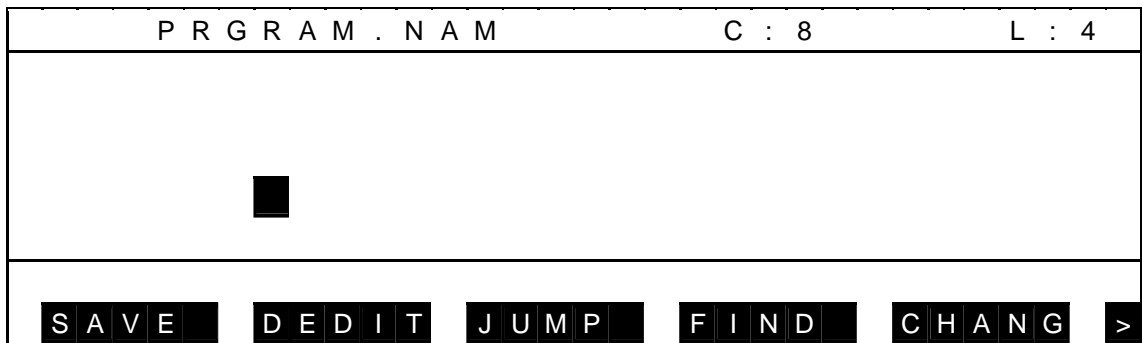

If the specified file exists in the RAM drive, the character input mode is selected with the contents of the specified file shown on the editing display. Now you can edit the file.

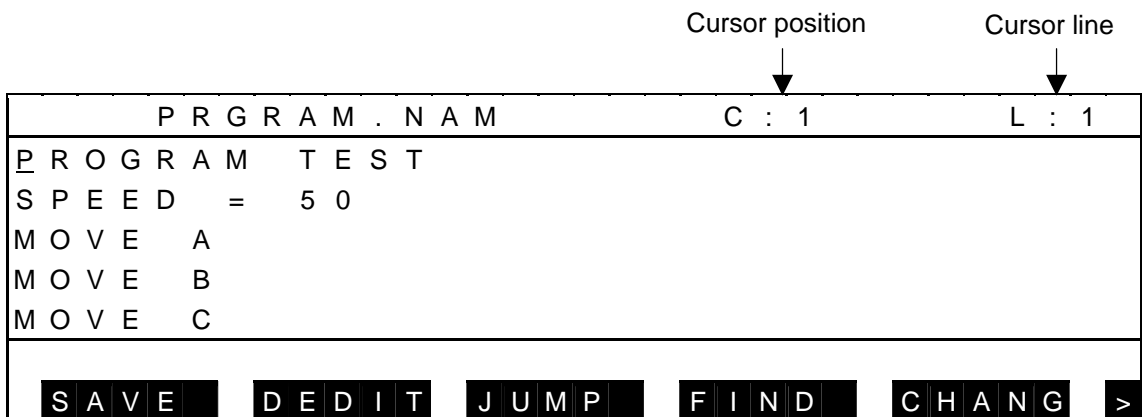

If the memory size of the file you specified is especially large, it may take about ten (10) seconds until "Opening [file name]" is displayed and you can start editing. Wait for a while.

If the file name you specified is illegal, the system returns to the initial display.

If there is not enough available memory space in the RAM drive and you cannot create a new file, or if the number of registered files is 256 and you cannot create a new file, the system returns to the initial display as well. Delete an unnecessary file or files, then execute [EDIT] again.

M O D E : T E A C H I N G / C O N T										1	2	3	4	5	6	7	8	.	1	2	3
										L : 9 9 9 9											
										O : 1 0 0 %											
										M : F R E E											
										S : S T O P											
										R E S E T											
:																					
E D I T				D E D I T				S E L C T				R U N				F I L E				>	

(3) Cautions

- A program is edited in the RAM drive.
- Unless a specified program exists in the RAM drive, the system interprets that you are going to create a new file and creates a new file of that name.
- If you wish to edit an existing file, you have to first load it into the RAM drive.
- If you omit designation of a file name, the file selected as the one for execution is taken as the file to be edited.
- Even if the master mode key switch is changed from "TEACHING" during program editing, the editing mode will not terminate.

4.2 Character Input

4.2.1 Character Input Mode Selection

(1) Function

This mode allows characters entered to be inserted or replaced through the keyboard at the cursor position on the editing display. Edit commands can be input directly.

(2) Procedures

(a) Step 1: Mode selection.

If the command select mode is selected, press the ESC key, and system returns to the character input mode. Use this operation to return to the character input mode without menu selection.

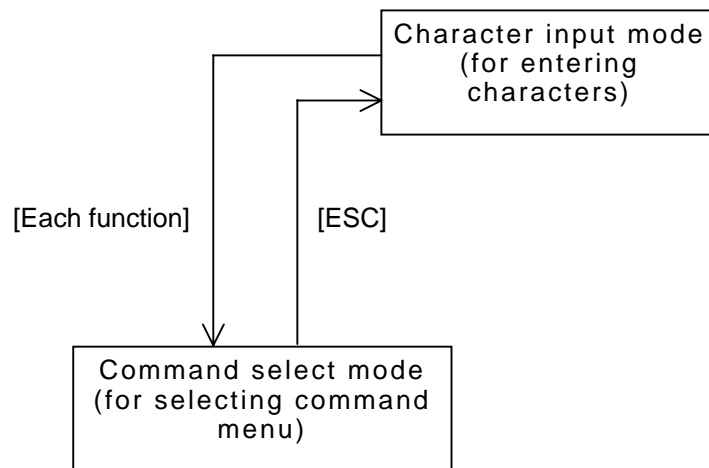

(3) Cautions

- When the program editor has started up, the character input mode becomes effective.
- After the command menu has been selected, the system automatically returns to the character input mode.
- In the character input mode, the cursor can be moved up and down, right and left on the editing display, using the cursor keys (↑, ↓, ←, →).

4.2.2 Insert Mode [INS]

(1) Function

Used to select the insert mode for character input. A character entered through the keyboard is inserted to the cursor position.

(2) Procedures

(a) Step 1: INS key operation.

Each time the INS key is pressed, the input mode or replace mode is selected alternately. When the insert mode is already selected, this operation is unnecessary.

(b) Step 2: Designation of insert position.

Move the cursor to a position where you wish to insert characters, using the cursor keys (\uparrow , \downarrow , \leftarrow , \rightarrow).

P R G R A M . N A M	C : 5	L : 1
P R O G <u>A</u> M T E S T		
S P E E D = 5 0		
M O V E A		
M O V E B		
M O V E C		
S A V E D E D I T J U M P F I N D C H A N G >		

(c) Step 3: Insertion.

Press a key for a desired character, and the character thus input is inserted at the cursor position.

P R G R A M . N A M	C : 5	L : 1
P R O G <u>R</u> A M T E S T		
S P E E D = 5 0		
M O V E A		
M O V E B		
M O V E C		
S A V E D E D I T J U M P F I N D C H A N G >		

(3) Related functions (Line insert)

- Line insertion

While the insert mode is selected, move the cursor to the top of a line where a character or characters are to be added, using the cursor keys (↑, ↓, ←, →).

P R G R A M . N A M	C : 5	L : 1
P R O G R A M T E S T		
S P E E D = 5 0		
M O V E A		
M O V E B		
M O V E D		
S A V E D E D I T J U M P F I N D C H A N G >		

Enter a line to be added through the keyboard, and it is inserted just before the line where the cursor was located.

P R G R A M . N A M	C : 7	L : 4
P R O G R A M T E S T		
S P E E D = 5 0		
M O V E A		
M O V E B M O V E C		
M O V E D		
S A V E D E D I T J U M P F I N D C H A N G >		

Press the EXE key, and the line where the cursor was located is shifted to the next line.

P R G R A M . N A M	C : 1	L : 5
P R O G R A M T E S T		
S P E E D = 5 0		
M O V E A		
M O V E B		
M O V E C		
S A V E D E D I T J U M P F I N D C H A N G >		

When the available memory space becomes small during editing operation, a warning saying "A few memory remains" is displayed. When this happens, quit the program editing mode, delete any unnecessary file or files, then resume the program editing operation.

If character input continues with the warning of "A few memory remains" displayed, a warning of "File full" is displayed and the subsequent character input is invalid. If you try to quit the program editing mode, a warning saying "Delete some data until rem >=0" is displayed, and you cannot finish the program editing. Delete program contents, then terminate the editing.

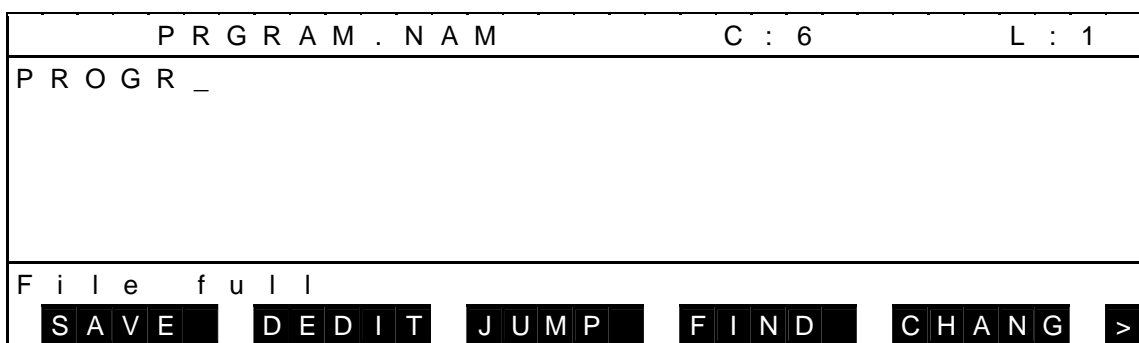

(4) Cautions

- When the program editor has started up, the insert mode takes effect.
- The insert mode is discriminated from the replace mode by the shape of the cursor.

Insert mode : _
 Replace mode : ■

- When the EXE key is pressed while the cursor is located at the top of a line in the insert mode, a blank line is inserted at the cursor position.

4.2.3 Replace Mode [Replace]

(1) Function

Used to select the replace mode for character input. A character entered through the keyboard is replaced with the one at the cursor position.

(2) Procedures

(a) Step 1: INS key operation.

Each time the INS key is pressed, the input mode or replace mode is selected alternately. When the replace mode is already selected, this operation is unnecessary.

(b) Step 2: Designation of replaced character.

Move the cursor to a character to be replaced, using the cursor keys (↑, ↓, ←, →).

P R G R A M . N A M	C : 5	L : 1
P R O G P A M T E S T		
S P E E D = 5 0		
M O V E A		
M O V E B		
M O V E C		
S A V E D E D I T J U M P F I N D C H A N G >		

(c) Step 3: Replacement.

Press a key for a desired replacing character, and the character thus input is replaced with the one at the cursor position.

P R G R A M . N A M	C : 5	L : 1
P R O G R A M T E S T		
S P E E D = 5 0		
M O V E A		
M O V E B		
M O V E C		
S A V E D E D I T J U M P F I N D C H A N G >		

(3) Cautions

- When the program editor has started up, the insert mode takes effect.
- The insert mode is discriminated from the replace mode by the shape of the cursor.

Insert mode : _

Replace mode : ■

4.2.4 Input Correction [BS]

(1) Function

While the character input mode is selected, one (1) character just before the cursor position can be deleted on the editing display.

This function is useful for deleting an error just after key entry.

(2) Procedures

(a) Step 1: Input correction.

Press the BS key, and one (1) character just before the cursor position is deleted with successive characters on the same line shifted left in turn.

P R G R A M . N A M	C : 6	L : 1 1
P R O G R A M T E S T		
S P E E D = 5 0		
M O V E A		
M O V E B		
M O V E C _		
S A V E D E D I T J U M P F I N D C H A N G >		

Press the BS key and the following displays appears.

P R G R A M . N A M	C : 5	L : 1 1
P R O G R A M T E S T		
S P E E D = 5 0		
M O V E A		
M O V E B		
M O V E _		
S A V E D E D I T J U M P F I N D C H A N G >		

4.2.5 Character Deletion [DEL]

- (1) Function
Deletes one (1) character at the cursor position.
- (2) Procedures
 - (a) Step 1: Designation of deleted character.
Move the cursor to a character to be deleted.

P R G R A M . N A M	C : 5	L : 1
P R O G H R A M T E S T		
S P E E D = 5 0		
M O V E A		
M O V E B		
M O V E C		
S A V E D E D I T J U M P F I N D C H A N G >		

- (b) Step 2: Deletion.
Press the ALT and BS keys, and the character at the cursor position is deleted with successive characters on the same line shifted left in turn.

P R G R A M . N A M	C : 5	L : 1
P R O G R A M T E S T		
S P E E D = 5 0		
M O V E A		
M O V E B		
M O V E C		
S A V E D E D I T J U M P F I N D C H A N G >		

- (3) Caution
 - When the character deletion is executed at the end of a line, a line feed is deleted with the next line succeeding the current line.

4.2.6 Moving the Cursor [↑] [↓] [←] [→]

(1) Function

Moves the cursor by one (1) character in the arrow-marked direction.

(2) Procedures

(a) Step 1: Cursor movement.

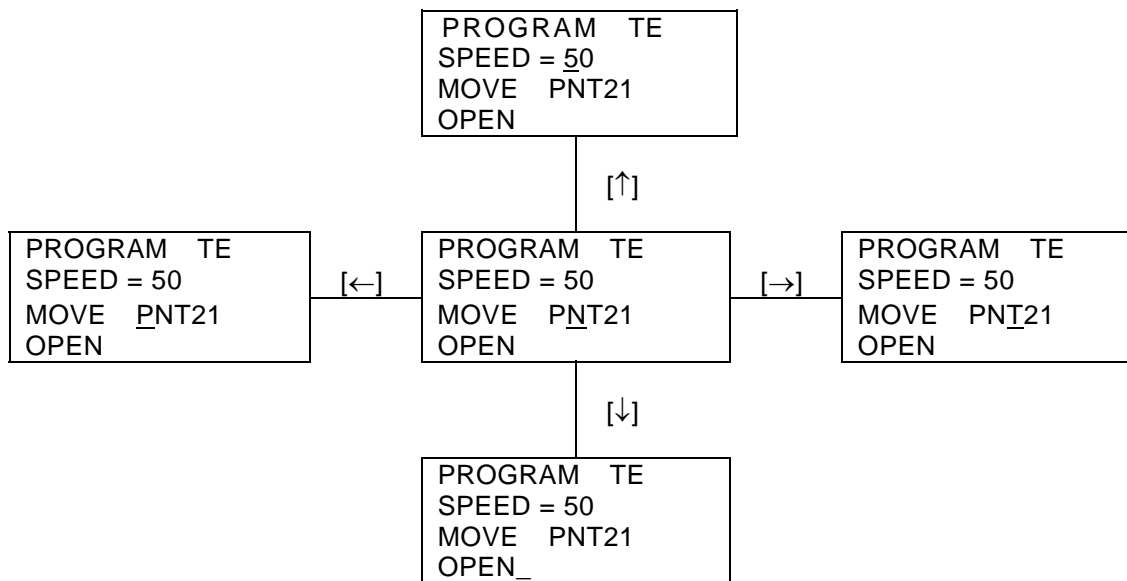

(3) Cautions

- When the cursor is moved from the top, bottom, right or left end of the display, it scrolls the screen in an appropriate direction. However, the cursor cannot be moved past the top line, bottom line, top of a line or end of a line.
- If the cursor is located after the line feed position, it is moved to the line feed position.

4.3 Edit Command Input

Edit commands can be input, using function keys.

4.3.1 List of Edit Commands

Menu	Descriptions
[SAVE]	Quit Saves the data and quits the editor.
[DEDIT]	Changes over to the data editor screen.
[JUMP]	Moves the cursor to specified line.
[FIND]	Searches a character string, and moves the cursor to the top of the initially found character string.
[CHANGE]	Searches the specified character string, and replaces with another character string.
[NOSAV]	Quits the editor without saving the data. All changed data are deleted.
[COPY]	Saves a block in buffer.
[CUT]	Cuts a block (saves in buffer).
[PASTE]	Pastes the buffer contents (data saved in the buffer through COPY or CUT operation) behind the cursor.

4.3.2 Command Menu Selection

- (1) Function
Inputs an edit command by menu selection.
- (2) Procedures
 - (a) Step 1: Designation of command execution position.
Move the cursor to a position on the editing display where you wish to execute an edit command, using the cursor keys (↑, ↓, ←, →).
 - (b) Step 2: Command selection.
Press a desired function key to select and execute a command.
When the NEXT key is pressed, other commands not currently displayed are called.

P R G R A M . N A M	C : 5	L : 1
P R O G R A M T E S T		
S P E E D = 5 0		
M O V E A		
M O V E B		
M O V E C		
S A V E	D E D I T	J U M P
F I N D	C H A N G	>

- (3) Cautions
 - For some commands, you have to specify a position where you wish to execute a command, using the cursor on the editing display, before menu selection.
 - For details, see the description in each paragraph of the edit command.
 - To return to the character input mode by canceling the menu selection, press the ESC key.

4.3.3 Input Correction [BS]

(1) Function

At execution of an edit command, one (1) character just before the cursor position can be deleted.

(2) Procedures

(a) Step 1: Deletion of input data.

Press the BS key repeatedly, and one (1) character just before the cursor position is deleted as necessary (In the example below, the jump command is being input.)

P R G R A M . N A M	C : 5	L : 1
P R O G R A M T E S T		
S P E E D = 5 0		
M O V E A		
M O V E B		
M O V E C		
L i n e : 1 0 _		
S A V E	D E D I T	J U M P F I N D C H A N G >

Press the BS key and the following displays appears.

P R G R A M . N A M	C : 5	L : 1
P R O G R A M T E S T		
S P E E D = 5 0		
M O V E A		
M O V E B		
M O V E C		
L i n e : 1 _		
S A V E	D E D I T	J U M P F I N D C H A N G >

Input a legal value through the keyboard.

(3) Caution

The cursor keys (←, →) are inoperative.

4.3.4 Cancel [ESC]

(1) Function

Clears the command line and cancels the execution of an edit command.

(2) Procedures

During execution of a command, press the ESC key before pressing the EXE key.

P R G R A M . N A M	C : 5	L : 1
P R O G R A M T E S T		
S P E E D = 5 0		
M O V E A		
M O V E B		
M O V E C		
L i n e : 1 0 _		
S A V E	D E D I T	J U M P F I N D C H A N G >

Press the ESC key and the following display appears.

P R G R A M . N A M	C : 5	L : 1
P R O G R A M T E S T		
S P E E D = 5 0		
M O V E A		
M O V E B		
M O I E C		
L i n e : _		
S A V E	D E D I T	J U M P F I N D C H A N G >

Press the ESC key and the following display appears.

P R G R A M . N A M	C : 5	L : 1
P R O G R A M T E S T		
S P E E D = 5 0		
M O V E A		
M O V E B		
M O I E C		
L i n e : _		
S A V E	D E D I T	J U M P F I N D C H A N G >

4.4 Descriptions on Edit Commands

4.4.1 Data Editing [DEDIT]

- (1) Function
Edits data.
- (2) Procedures
 - (a) Step 1: Startup of data editor.
Press [DEDIT] to start up the data editor. For details, see Section 5.

4.4.2 Jump to Specified Line [JUMP]

- (1) Function
Displays the edit screen including the specified line, and move the cursor to the top of the specified line.
- (2) Procedures
 - (a) Step 1: Execution of jump command.
Press [JUMP] to execute the jump command.

P R G R A M . N A M	C : 1	L : 1
P R O G R A M T E S T		
S P E E D = 5 0		
M O V E A		
M O V E B		
M O V E C		
L i n e : _		
S A V E	D E D I T	J U M P
F I N D	C H A N G	>

(b) Step 2: Input of specified line.

Make sure that "Line:" is displayed on the last line of the display, then enter a line number where you wish to jump.

P R G R A M . N A M	C : 1	L : 1
P R O G R A M T E S T		
S P E E D = 5 0		
M O V E A		
M O V E B		
M O V E C		
L i n e : 1 0 _		
S A V E	D E D I T	J U M P F I N D C H A N G >

(c) Step 3: Input through EXE key.

Press the EXE key, and a screen including the specified line is displayed with the cursor moved to the head of the specified line.

P R G R A M . N A M	C : 1	L : 1 0
S P E E D = 1 0 0		
M O V E A		
<u>S</u> P E E D = 7 5		
M O V E B		
E N D		
S A V E	D E D I T	J U M P F I N D C H A N G >

(3) Caution

If you have specified a line number greater than the number of the last line, the cursor moves to the head of the last line.

(4) Reference

If you specify the "+" or "-" sign, the cursor jumps to the relative position from the current line.

4.4.3 Deleting Block [CUT]

(1) Function

Deletes the range of set blocks, and shifts the subsequent data upward and displays them.

(2) Procedures

(a) Step 1: Designation of start block position.

Set the range of blocks to be deleted.

Move the cursor to the first character of a desired start block.

P R G R A M . N A M	C : 1	L : 2
P R O G R A M T E S T		
<u>S</u> P E E D = 5 0		
M O V E A		
M O V E B		
M O V E C		
N O S A V C O P Y C U T P A S T E >		

(b) Step 2: Execution of range selection.

Press [CUT] to execute the range selection.

P R G R A M . N A M	C : 1	L : 2
P R O G R A M T E S T		
<u>S</u> P E E D = 5 0		
M O V E A		
M O V E B		
M O V E C		
C U T R A N G > N O S A V C O P Y C U T P A S T E >		

(c) Step 3: Designation of end position.

Move the cursor so that the final character of the specified range is indicated by the reversed image. The specified range of blocks is inversely displayed and you can delete the blocks under this condition.

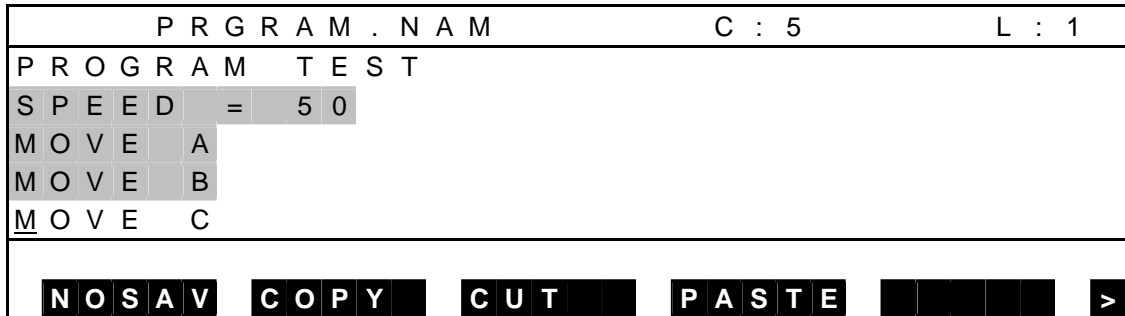

(d) Step 4: Deletion of specified range.

Press [CUT], and the contents of the specified range of blocks are saved in the buffer with the specified range of blocks deleted.

The contents thus saved can be pasted at any desired position by pressing [PASTE].

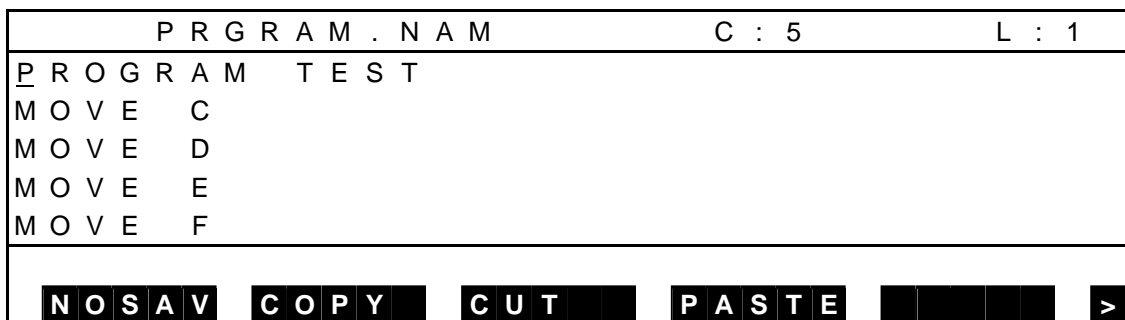

If the memory becomes full during setting, a warning saying "No more space in cut buffer" is displayed.

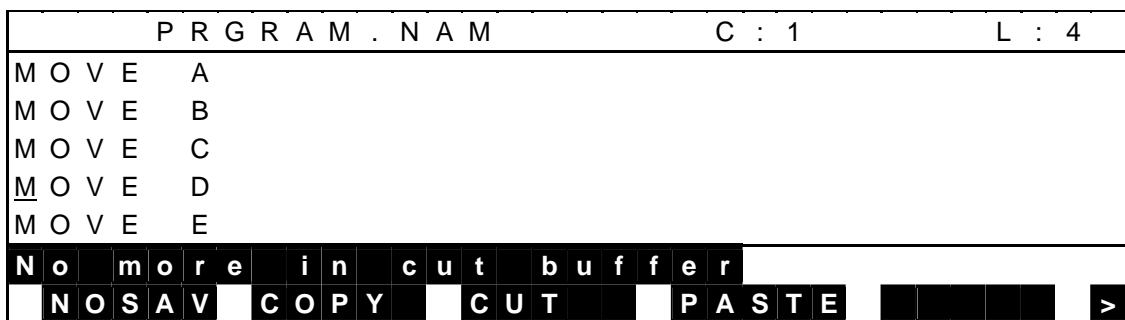

(3) Caution

The deleted blocks are saved in the internal buffer.

4.4.4 Copying [COPY]

- (1) Function
Saves a specified range of blocks in the buffer.
- (2) Procedures
 - (a) Step 1: Designation of start block position.
Designating the start block of a range to be copied.
Move the cursor to the first character of a desired start block.

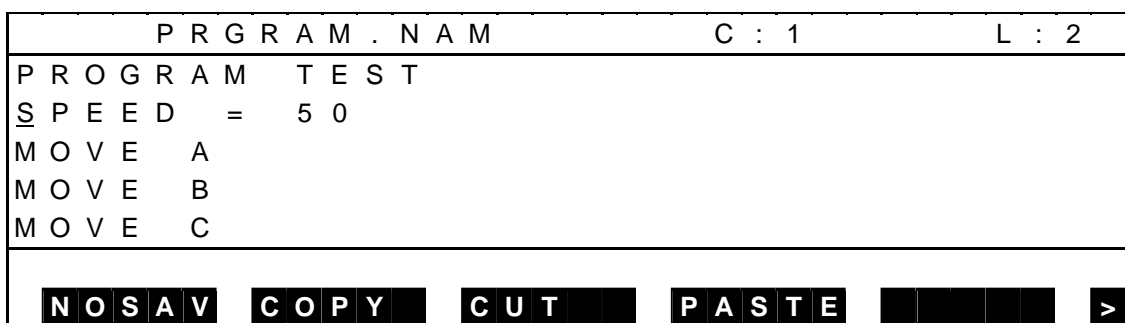

- (b) Step 2: Execution of copy command.
Press [COPY] to execute the copy command.

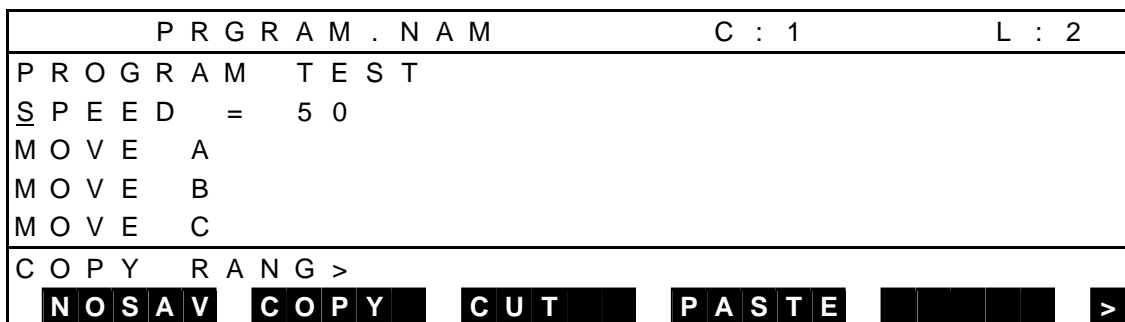

- (c) Step 3: Designation of end position.
Move the cursor so that the final character of the specified range is indicated by the reversed image. The specified range of blocks is inversely displayed and you can copy the blocks under this condition.

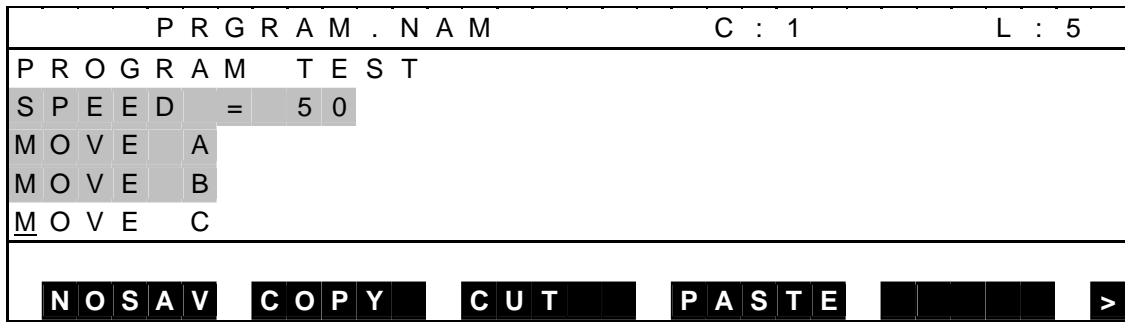

(d) Step 4: Copy of specified range.

Press [COPY], and the contents of the specified range of blocks are saved in the buffer. The contents thus saved can be pasted at any desired position by pressing [PASTE].

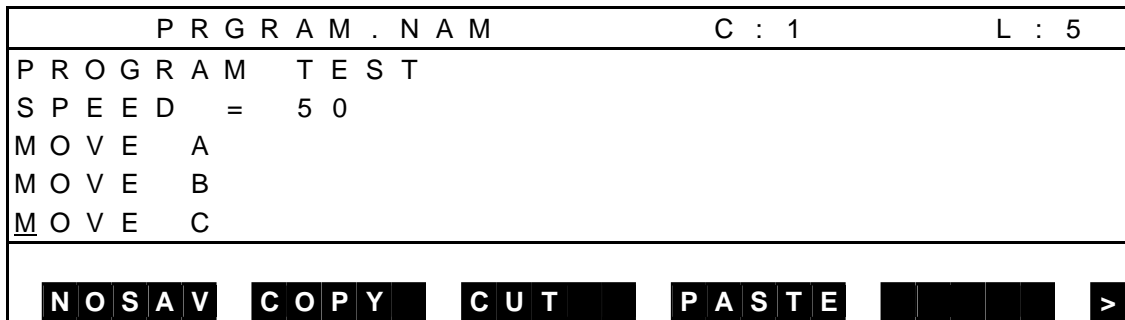

If the memory becomes full during copying, a warning saying "No more space in cut buffer" is displayed.

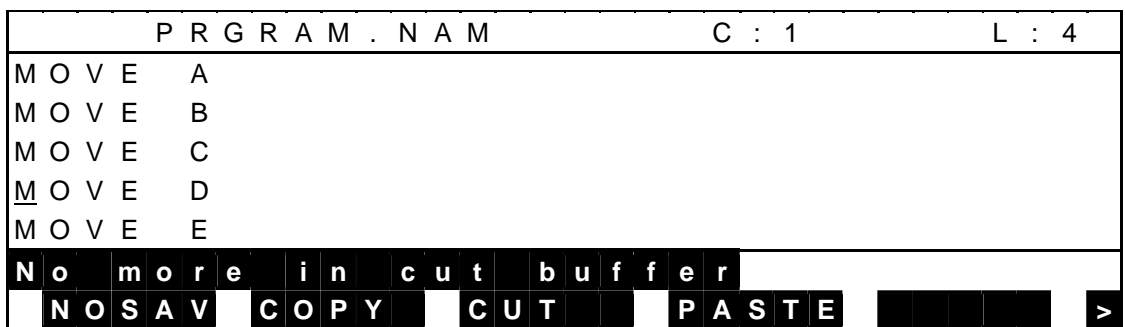

(3) Caution

- If the memory becomes full during copying, the copying is not possible.

4.4.5 Pasting [PASTE]

(1) Function

Pastes the contents saved by the [COPY] or [CUT] command.

(2) Procedures

(a) Step 1: Designation of position to paste.

Move the cursor to just before the position where you wish to insert a block or blocks.

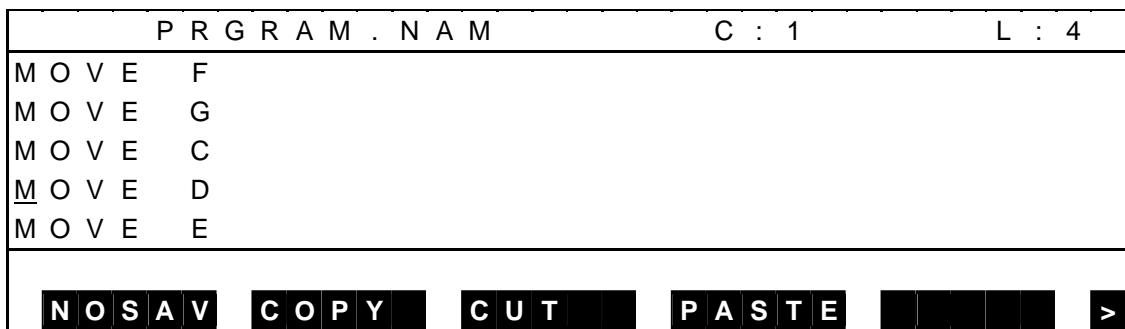

(b) Step 2: Execution of paste command.

Press [PASTE] to execute the paste command. After pasting, the cursor moves after the finally pasted block.

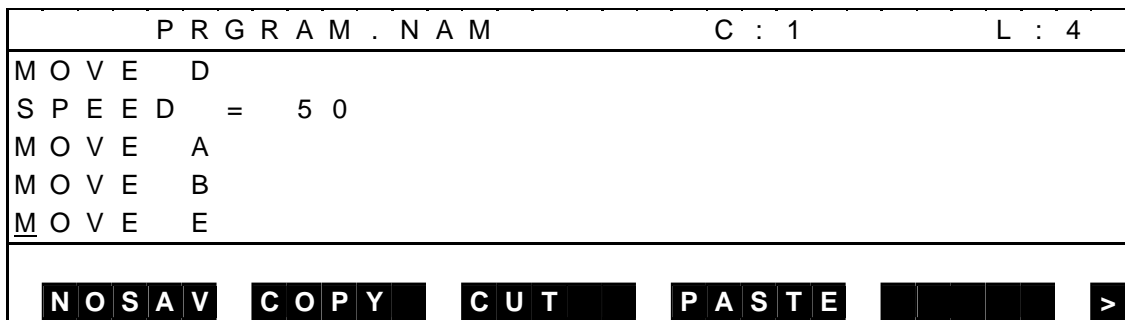

Unless a block or blocks are specified, copying is invalid. When this happens, a message saying "No source block" is displayed to terminate copying.

P R G R A M . N A M										C : 1		L : 2	
P R O G R A M T E S T													
S P E E D = 5 0													
M O V E A													
M O V E B													
M O V E C													
N o s o u r c e b l o c k													
N O S A V C O P Y C U T P A S T E >													

(3) Caution

Unless a block or blocks are specified in the internal buffer, pasting is invalid.

4.4.6 Searching Character String [FIND]



CAUTION

Kanji and Kana characters contained in a program cannot be searched.

(1) Function

Searches a specified character string, starting from the position next to the cursor position, displays the editing screen including the initially searched character string and moves the cursor to the top of the character string.

(2) Procedures

(a) Step 1: Execution of find command.

Press [FIND] to execute the find command.

P R G R A M . N A M	C : 5	L : 1
P R O G R A M T E S T		
S P E E D = 5 0		
M O V E A		
M O V E B		
M O V E C		
P a t t e r n : _		
S A V E	D E D I T	J U M P
F I N D	C H A N G	>

(b) Step 2: Input of searched character string.

Make sure that "Pattern:" is displayed, then enter a character string to be searched.

P R G R A M . N A M	C : 5	L : 1
P R O G R A M T E S T		
S P E E D = 5 0		
M O V E A		
M O V E B		
M O V E C		
P a t t e r n : M O V E S _		
S A V E	D E D I T	J U M P
F I N D	C H A N G	>

- (c) Step 3: Input through EXE key.
Press the EXE key, and the search starts. The cursor moves to the top of the character string initially found.

P R G R A M . N A M	C : 1	L : 8
M O V E A		
S P E E D = 1 0 0		
M O V E S C		
S P E E D = 7 5		
M O V E D		
<div style="display: flex; justify-content: space-between; padding: 0;"> SAVE EDIT JUMP FIND CHANGE > </div>		

Unless the specified character string exists, a message of "Not found." is displayed and the character string search terminates.

P R G R A M . N A M	C : 5	L : 1
P R O G R A M T E S T		
S P E E D = 5 0		
M O V E A		
M O V E B		
M O V E C		
<div style="display: flex; justify-content: space-between; padding: 0;"> Not found. </div> <div style="display: flex; justify-content: space-between; padding: 0;"> SAVE EDIT JUMP FIND CHANGE > </div>		

- (3) Caution
Unless the specified character string has been found until the final line, the search continues from the top line to the cursor position.

4.4.7 Replacing Character String [CHANG]



CAUTION

Kanji and Kana characters contained in a program cannot be searched.

(1) Function

Searches a specified character string, starting from the cursor position and replaces it with another character string.

(2) Procedures

(a) Step 1: Execution of change command.

Press [CHANG] to execute the change command.

P R G R A M . N A M	C : 5	L : 1
P R O G R A M T E S T		
S P E E D = 5 0		
M O V E A		
M O V E B		
M O V E C		
P a t t e r n : _		
S A V E	D E D I T	J U M P F I N D C H A N G >

(b) Step 2: Input of searched character string.

Make sure that "Pattern:" is displayed on the last line of the display, enter a character string to be searched and press the EXE key.

P R G R A M . N A M	C : 5	L : 1
P R O G R A M T E S T		
S P E E D = 5 0		
M O V E A		
M O V E B		
M O V E C		
P a t t e r n : M O V E _		
S A V E	D E D I T	J U M P F I N D C H A N G >

(c) Step 3: Input of replacement character string.

Make sure that "Replacement:" is displayed on the last line of the display, enter a replacement character string and press the EXE key.

P R G R A M . N A M	C : 5	L : 1
P R O G R A M T E S T		
S P E E D = 5 0		
M O V E A		
M O V E B		
M O V E C		
R e p l a c e m e n t : M O V E S _		
SAVE	DEDIT	JUMP FIND CHANG >

Unless the specified character string exists, a message of "Not found." is displayed and the character string replacement terminates.

P R G R A M . N A M	C : 5	L : 1
P R O G R A M T E S T		
S P E E D = 5 0		
M O V E A		
M O V E B		
M O V E C		
N o t f o u n d .		
SAVE	DEDIT	JUMP FIND CHANG >

(d) Step 4: Confirmation of replacement.

The cursor moves to the top of the character string initially found with the following message displayed.

P R G R A M . N A M	C : 1	L : 3
P R O G R A M T E S T		
S P E E D = 5 0		
<u>M</u> O V E A		
M O V E B		
M O V E C		
0 : l o c a l , 1 : g l o b a l , E S C : e x i t		
SAVE	DEDIT	JUMP FIND CHANG >

When the [0] key is pressed, the character string at the cursor position is replaced with another character string. The cursor moves to the top of the character string found next with the confirmation message displayed again.

P R G R A M . N A M	C : 1	L : 3
P R O G R A M T E S T		
S P E E D = 5 0		
M O V E S A		
M O V E B		
M O V E C		
0 : l o c a l , 1 : g l o b a l , E S C : e x i t		
S A V E	D E D I T	J U M P F I N D C H A N G >

When the [1] key is pressed, all character strings identical with the specified character string are replaced with the new character string. If the specified character string does not exist any more, a message of "Not found." is displayed to cancel the character string replacement.

P R G R A M . N A M	C : 5	L : 1
P R O G R A M T E S T		
S P E E D = 5 0		
M O V E S A		
M O V E S B		
M O V E S C		
N o t f o u n d .		
S A V E	D E D I T	J U M P F I N D C H A N G >

Press the ESC key to quit the replacement.
 If any other key is pressed, the system skips the character string at the cursor position and moves the cursor to the top of the character string found next with the confirmation message displayed again.

P R G R A M . N A M	C : 1	L : 3
P R O G R A M T E S T		
S P E E D = 5 0		
M O V E A		
M O V E B		
M O V E C		
0 : l o c a l , 1 : g l o b a l , E S C : e x i t		
S A V E	D E D I T	J U M P F I N D C H A N G >

(3) Cautions

- Unless the specified character string has been found until the final line, the search continues from the top line to the cursor position.
- If the memory becomes full at character string replacement, the character string replacement is invalid. When this happens, a message of "file full" is displayed to cancel the character string replacement.

4.4.8 Quit [SAVE]

- (1) Function
Saves a program and exits the editor.
- (2) Procedures
 - (a) Step 1: Execution of save command.
Press [SAVE] to execute the save command. The confirmation message is displayed.

P R G R A M . N A M	C : 1	L : 8
M O V E A		
S P E E D = 1 0 0		
M O V E S C		
S P E E D = 7 5		
M O V E D		
[S A V E] O K T H E N < E X E >		
S A V E	D E D I T	J U M P
F I N D	C H A N G	>

- (b) Press the EXE key, and the program is saved and the system returns to the teaching mode display.

M O D E : T E A C H I N G / C O N T	1 2 3 4 5 6 7 8 . 1 2 3
	L : 9 9 9 9
	O : 1 0 0 %
	M : F R E E
	S : S T O P
	R E S E T
>	
E D I T	D E D I T
S E L	R U N
F I L E	>

To cancel the save function, press the ESC key, and you can continue editing.

4.4.9 Aborting and Quitting Edit [NOSAVE]

(1) Function

Aborts and quits the editor.

(2) Procedures

(a) Step 1: Execution of "NOSAVE" command.

Press [NOSAV] to execute the "NOSAVE" command. The confirmation message is displayed.

P R G R A M . N A M	C : 1	L : 2
P R O G R A M T E S T		
S P E E D = 5 0		
M O V E A		
M O V E B		
M O V E C		
[N O S A V E] O K T H E N < E X E >		
N O S A V	C O P Y	C U T P A S T E >

(b) Press the EXE key, and editing of the program is aborted and the system returns to the teaching mode display.

M O D E : T E A C H I N G / C O N T	1 2 3 4 5 6 7 8 . 1 2 3
	L : 9 9 9 9
	O : 1 0 0 %
	M : F R E E
	S : S T O P
	R E S E T
>	
E D I T	D E D I T S E L R U N F I L E >

To cancel the "NOSAVE" function, press the ESC key, and you can continue editing.

(3) Cautions

- The contents edited are canceled to keep the original program.
- If a data format error occurs at the start of editing, a backup file is not created. Even if the "NOSAVE" command is executed, the original file cannot be maintained.

4.5 Automatic Start File

(1) Function

If a batch file named "AUTOSTR. BAT" is created which contains commands, the file can be executed automatically when the power is turned on.

(2) Procedures

(a) Step 1: Mode selection.

Set the master mode switch on the control panel to "TEACHING."

(b) Step 2: Menu selection.

Press the NEXT key repeatedly until [EDIT] is displayed in the menu, and then press the corresponding function key.

M O D E : T E A C H I N G / C O N T										1	2	3	4	5	6	7	8	.	1	2	3
										L :			9 9								
										O :			2 0 %								
										M :			F R E E								
										S :			S T O P								
										R E S E T											
E D I T		D E D I T		S E L		R U N		F I L E		>											

(c) Step 3: Designation of file name.

Enter "AUTOSTR. BAT" for the file name. The extension is BAT.

To create a new file, press [INPUT] and enter the name.

F I L E S E L E C T										(0 0 1 / 2 5 6)																			
*	A	B	C	D	1	2	3	4	.	5	6	7	1	2	3	4	5	6	F	e	b	-	1	2	-	2	0	0	8
	F	I	L	E	0	0	0	2	.	0	1	2	1	2	3	4	5	6	F	e	b	-	1	3	-	2	0	0	8
	F	I	L	E	0	0	0	3	.	0	1	2	1	2	3	4	5	6	F	e	b	-	1	4	-	2	0	0	8
	F	I	L	E	0	0	0	4	.	0	1	2	1	2	3	4	5	6	F	e	b	-	1	5	-	2	0	0	8
	F	I	L	E	0	0	0	5	.	0	1	2	1	2	3	4	5	6	F	e	b	-	1	6	-	2	0	0	8
: A U T O S T R . B A T																													
N A M E			T I M E			I N P U T																							

- (d) Step 4: Check the file name to be edited.
 Check that the file name is correct, and press the EXE key.
 To change the file name, use the BS key to return the cursor, enter the new file name using the keyboard, and then press the EXE key.
- (e) Step 5: Creation of batch file.
 Enter a command that is enabled in batch processing and a file name that executes the command line by line.

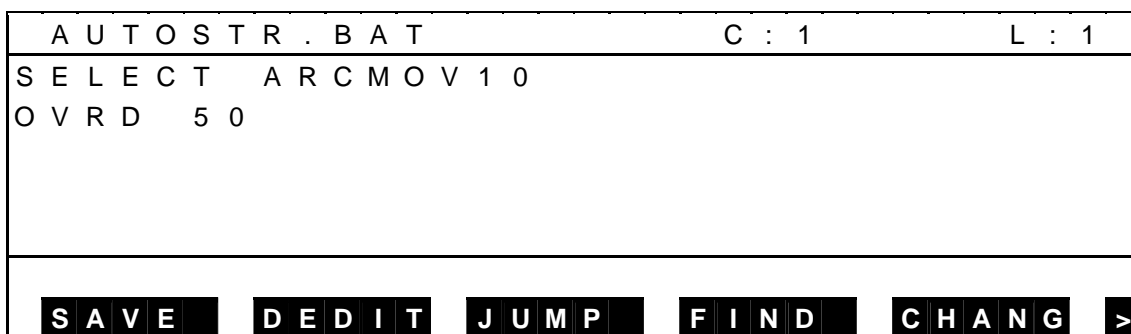

- (f) Step 6: Quit the editor.
 Press [SAVE] to quit the editor.

This completes the creation of the batch file for batch processing.

- (3) Execution of batch file
 If the AUTOSTR. BAT file is stored in the RAM drive when the power is turned on, the batch file is automatically executed after the startup process.
- (4) Cautions
 - The following commands are enabled in batch processing

SELECT <file name>	: Selecting file
OVRD <override setting value>	: Override setting
DATE	: Date display
TIME	: Time display
SVON	: Servo ON command
RUN	: Program run command
 - The SVON command is enabled in internal automatic (INTERNAL) mode and external automatic (EXT) mode.

Section 5 Data Editing

The data editing function allows input and editing of positional data, coordinate data and load data. Each data is saved in a file together with a program, and can be edited on the file basis.

5.1 Starting Up the Data Editor

The data editor can be started up in one of the following two (2) manners.

1. [DEDIT] of basic menu
2. [DEDIT] of program editing menu

For the startup procedures from the program editing menu, see Section 4. This section describes the startup procedures from the basic menu.

(1) Procedures

- (a) Step 1: File selection screen display.

Call the basic display as shown below.

M O D E : T E A C H I N G / C O N T												
								L :				
								O :	20 %			
								M :	F R E E			
								S :	S T O P			
									R E S E T			
E	D	I	T					F	I	L	E	>

Press [DEDIT].

E	D	I	T										[0	0	1	/	0	1	0]
P	R	G	1			1	0	0	0	S	e	p	-	0	1	-	2	0	0	8	
P	R	G	2			1	4	5		S	e	p	-	0	1	-	2	0	0	8	
T	E	S	T	1		1	0	0		S	e	p	-	0	2	-	2	0	0	8	
T	E	S	T	2		1	0	0		S	e	p	-	0	2	-	2	0	0	8	
T	E	S	T	3		1	2	3	4	5	S	e	p	-	0	3	-	2	0	0	8
N	A	M	E		T	I	M	E		N	E	W									

For details on the file selection screen, see Section 4.

(b) Step 2: Data editing startup.

Select or input a file you are going to edit, and press the EXE key. The data editor starts up. When the data editor has started up initially, the following world coordinate positional data directory is displayed.

P O I N T	X	Y	Z
P O I N T 0 0 0 0 1 =	1 0 ,	0 ,	0 ,
P O I N T 0 0 0 0 2 =	2 0 ,	0 ,	0 ,
P O I N T 0 0 0 0 3 =	1 0 0 ,	1 0 0 ,	1 0 0 ,
P O I N T 0 0 0 0 4 =	2 0 0 ,	2 0 0 ,	2 0 0 ,
↓ P O I N T 0 0 0 0 5 =	3 0 0 ,	3 0 0 ,	3 0 0 ,
P O I N T 0 0 0 0 1 w / . w o r l d			
SAVE PRG FULL TRANS PYLD >			

For the new file, no data is available, and only the title is displayed as shown below.

P O I N T	X	Y	Z
w / . w o r l d			
SAVE PRG TRANS PYLD >			

- New data can be created, using the INS key. For details, see Para. 5.2.
- When the data editor has been started up by [DEDIT] of the basic menu, the [PRG] menu as shown above is not displayed. It is displayed only when the data editor has been started up by [DEDIT] of the program editing menu. (See Caution below.)

(2) Caution

Though some menu keys are not displayed unless they work, all menu keys are displayed for convenience of explanations.

5.2 Positional Data Directory Display Mode

The positional data directory display mode displays one (1) positional data of each coordinate system on the same line.

Data displayed immediately after the startup are those in the world coordinate system. In this mode, it is possible to add, delete, and edit the positional data. An example of display is given below.

	P O I N T	X	Y	Z
↑	P O I N T 0 0 0 0 3 =	1 0 0 ,	1 0 0 ,	1 0 0 ,
	P O I N T 0 0 0 0 4 =	2 0 0 ,	2 0 0 ,	2 0 0 ,
	P O I N T 0 0 0 0 5 =	3 0 0 ,	3 0 0 ,	3 0 0 ,
	P O I N T 0 0 0 0 6 =	4 0 0 ,	4 0 0 ,	4 0 0 ,
↓	P O I N T 0 0 0 0 7 =	5 0 0 ,	5 0 0 ,	5 0 0 ,
P O I N T 0 0 0 0 5		w / . w o r l d		
SAVE		PRG	FULL	TRANS PYLD >

Each time the NEXT key is pressed, the menu is changed over as follows:

N O S A V	F I N D	T E A C H	M - T O	C U T	>
P A S T E					>



















- An inversely displayed section in the data is called the "main cursor" which indicates that this data is selected for editing.
- Symbol "↑" shown in the 1st column signifies that there is positional data before the top data.
- Symbol "↓" shown in the 1st column signifies that there is positional data after the final data.
- C and T data, and configuration data are displayed when you move the main cursor to the right.
- Data following "w/" on the right side of the command line identifies the coordinate data to which the selected positional data belongs.
- Though the name of array positional data, etc., can consist of up to twenty (20) characters, only ten (10) characters from the top are displayed in this mode. For the data indicated by the main cursor, however, all data are displayed on the command line.

- For the X, Y, Z, C, and T data, a value of four (4) digits and three (3) digits above and below the decimal point, respectively, can be input. In this mode, however, only a value of four (4) digits above the decimal point is displayed. For the data indicated by the main cursor, a full value is displayed, including decimal fractions.

When you display values included in C data and subsequent data, move the main cursor to the right. The following display appears.

Z	C	T	C O N F I G
1 0 0 ,	1 0 0 ,	0 /	F R E E
2 0 0 ,	0 ,	0 /	F R E E
3 0 0 ,	0 ,	0 /	R I G H T Y
4 0 0 ,	0 ,	0 /	L E F T Y
5 0 0 ,	0 ,	0 /	F R E E
1 0 0 . 0 0 0			w / . w o r l d
SAVE	PRG	FULL	TRANS PYLD >

Keys operative in this mode and their operations are shown below.

Key	Descriptions
	Used to move the main cursor to the left. If the main cursor is located under the name column, it will not move any further. When C data and subsequent data are displayed, move the cursor from Z data to Y data and the screen scrolls to the right.
	Used to move the main cursor to the right. When the main cursor is located under the "CONFIG" column, it will not move any further. When moving the cursor from Z data to C data, the screen scrolls to the left.
	Used to move the main cursor up. If the main cursor is located on the top line of the screen, the screen scrolls down. If the main cursor is on the top data, it will not move any further.
	Used to move the main cursor down. If the main cursor is located on the last line of the screen, the screen scrolls up. If the main cursor is on the final data, it will not move any further.
 + 	Used to display a positional data directory in a coordinate system defined before.
 + 	Used to display a positional data directory in a coordinate system defined after.
 + 	Used to move the main cursor up on the screen basis.
 + 	Used to move the main cursor down on the screen basis.
	Used to create a new positional data just below the main cursor line.
 + 	Used to delete a positional data indicated by the main cursor.
	Used to edit a data indicated by the main cursor.
	Used to toggle the menu (resulting in the next menu).
 + 	Used to toggle the menu (resulting in the previous menu).

Operations of each command menu are shown below.

Menu	Descriptions
[SAVE]	Used to save a data and quit the data editor. (When the data editor was started up from the program editor, the program editor terminates also.)
[PRG]	Used to select the program editor display. If the data editor was started using [DEDIT], [PRG] is not displayed on the command menu.
[FULL]	Used to select the detailed positional data display. For details, see Para. 5.3.
[TRANS]	Used to select the coordinate data editor display. For details, see Para. 5.4.
[PYLD]	Used to select the load data editor display. For details, see Para. 5.6.
[NOSAV]	Used to quit the editor without saving data. All changed data are aborted. (When the data editor was started up from the program editor, the program editor terminates also.)
[FIND]	Used to search a position name. For details, see Para. 5.2.4.
[TEACH]	Used to teach a current positional of the robot in a positional data indicated by the main cursor. For details, see Para. 5.2.
[M-TO]	Used to move the robot to a position indicated by the main cursor. For details, see Para. 5.2
[CUT]	Used to select the range select mode. For details, see Para. 5.2
[PASTE]	Used to paste the contents saved in the cut buffer (i.e., data deleted by the previous cut menu) after a positional data indicated by the main cursor to clear the cut buffer. For details, see Para. 5.2

For details of each command menu, see the descriptions given later.

5.2.1 Editing of Positional Data Name

(1) Function

Edits a positional data name.

(2) Procedures

When you press the EXE key while the main cursor is located at the position name, you can edit the position name.

In the example below, assume that you are going to change the name of "POINT00005" to "POINT55555."

(a) Step 1: Command selection.

Move the main cursor to "POINT00005" by means of the cursor keys (↑, ↓, →, ←), and the following display appears.

	P O I N T	X	Y	Z
↑	P O I N T 0 0 0 0 3 =	1 0 0 ,	1 0 0 ,	1 0 0 ,
	P O I N T 0 0 0 0 4 =	2 0 0 ,	2 0 0 ,	2 0 0 ,
	P O I N T 0 0 0 0 5 =	3 0 0 ,	3 0 0 ,	3 0 0 ,
	P O I N T 0 0 0 0 6 =	4 0 0 ,	4 0 0 ,	4 0 0 ,
↓	P O I N T 0 0 0 0 7 =	5 0 0 ,	5 0 0 ,	5 0 0 ,
P O I N T 0 0 0 0 5 w / . w o r l d				
SAVE PRG FULL TRANS PYLD >				

Press the EXE key, and the following display is called. (The cursor is displayed on the command line.)

	P O I N T	X	Y	Z
↑	P O I N T 0 0 0 0 3 =	1 0 0 ,	1 0 0 ,	1 0 0 ,
	P O I N T 0 0 0 0 4 =	2 0 0 ,	2 0 0 ,	2 0 0 ,
	P O I N T 0 0 0 0 5 =	3 0 0 ,	3 0 0 ,	3 0 0 ,
	P O I N T 0 0 0 0 6 =	4 0 0 ,	4 0 0 ,	4 0 0 ,
↓	P O I N T 0 0 0 0 7 =	5 0 0 ,	5 0 0 ,	5 0 0 ,
P O I N T 0 0 0 0 5 _ w / . w o r l d				
SAVE PRG FULL TRANS PYLD >				

- Current data is displayed as the initial value on the command line.
- The cursor on the command line is displayed next to the initially displayed name, and you can edit the data.
- When the cursor is shown by the mark "■", the replace mode takes effect. When the cursor is shown by the mark "_", the insert mode is effective.

(b) Step 2: Data input.

Enter a desired name to the command line, using alphanumeric keys, → key, and ← key. Then the following display appears.

	P O I N T	X	Y	Z
↑	P O I N T 0 0 0 0 3 =	1 0 0 ,	1 0 0 ,	1 0 0 ,
	P O I N T 0 0 0 0 4 =	2 0 0 ,	2 0 0 ,	2 0 0 ,
	P O I N T 0 0 0 0 5 =	3 0 0 ,	3 0 0 ,	3 0 0 ,
	P O I N T 0 0 0 0 6 =	4 0 0 ,	4 0 0 ,	4 0 0 ,
↓	P O I N T 0 0 0 0 7 =	5 0 0 ,	5 0 0 ,	5 0 0 ,
	P O I N T 5 5 5 5 5 _	w / . w o r l d		
	S A V E	P R G	F U L L	T R A N S P Y L D >

Keys operative in the command line input mode and their operations are shown below.

Key	Descriptions
←	Used to move the cursor left on the command line.
→	Used to move the cursor right on the command line.
Numeral Alphabet	Used to input characters on the command line.
EXE	Used to change current position name to an entered one. The system returns to the positional data directory display mode, and the main cursor moves to the X data area.
INS	Used to select the insert or replace mode for the command line.
BS	Used to delete one (1) character just before the cursor position on the command line.
ALT+BS	Used to delete one (1) character at the cursor position on the command line.
ESC	This function works in a different manner according to the presence or absence of input character(s). Presence of input character(s): All input character(s) on the command line are cleared. Absence of input character(s): The system returns to the positional data directory display.

Press the EXE key, and the position name is replaced by the newly specified name. The following display appears.

	P O I N T	X	Y	Z
↑	P O I N T 0 0 0 0 3 =	1 0 0 ,	1 0 0 ,	1 0 0 ,
	P O I N T 0 0 0 0 4 =	2 0 0 ,	2 0 0 ,	2 0 0 ,
	P O I N T 5 5 5 5 5 =	3 0 0 ,	3 0 0 ,	3 0 0 ,
	P O I N T 0 0 0 0 6 =	4 0 0 ,	4 0 0 ,	4 0 0 ,
↓	P O I N T 0 0 0 0 7 =	5 0 0 ,	5 0 0 ,	5 0 0 ,
3 0 0 . 1 2 3 w / . w o r l d				
S A V E P R G F U L L T R A N S P Y L D >				

(3) Cautions

- The main cursor moves to the X data area.
- If the input name is illegal, a message saying "ILLEGAL NAME" is displayed on the command line and no data is changed. Press any key, and the system returns to the name editing mode.
- If the specified name already exists, a message of "DUPLICATE NAME" is displayed on the command line and no data is changed. Press any key, and the system returns to the name editing mode.

5.2.2 Editing of Position Element

(1) Function

Used to edit a position element.

(2) Procedures

When you press the EXE key while the main cursor is located at each position element, you can edit that data.

In the example below, assume that you are going to change the X data of "POINT00005" from "300.123" to "333."

(a) Step 1: Selection of position element to be edited.

Move the main cursor to the data you wish to edit by means of the cursor keys (↑, ↓, →, ←), and the following display appears.

	P O I N T	X	Y	Z
↑	P O I N T 0 0 0 0 3 =	1 0 0 ,	1 0 0 ,	1 0 0 ,
	P O I N T 0 0 0 0 4 =	2 0 0 ,	2 0 0 ,	2 0 0 ,
	P O I N T 5 5 5 5 5 =	3 0 0 ,	3 0 0 ,	3 0 0 ,
	P O I N T 0 0 0 0 6 =	4 0 0 ,	4 0 0 ,	4 0 0 ,
↓	P O I N T 0 0 0 0 7 =	5 0 0 ,	5 0 0 ,	5 0 0 ,
3 0 0 . 1 2 3 w / . w o r l d				
SAVE PRG FULL TRANS PYLD >				

(b) Step 2: Data input.

Press the EXE key, and the following display is called. (The cursor is displayed on the command line.)

	P O I N T	X	Y	Z
↑	P O I N T 0 0 0 0 3 =	1 0 0 ,	1 0 0 ,	1 0 0 ,
	P O I N T 0 0 0 0 4 =	2 0 0 ,	2 0 0 ,	2 0 0 ,
	P O I N T 5 5 5 5 5 =	3 0 0 ,	3 0 0 ,	3 0 0 ,
	P O I N T 0 0 0 0 6 =	4 0 0 ,	4 0 0 ,	4 0 0 ,
↓	P O I N T 0 0 0 0 7 =	5 0 0 ,	5 0 0 ,	5 0 0 ,
3 0 0 . 1 2 3 _ w / . w o r l d				
SAVE PRG FULL TRANS PYLD >				

- Current data is displayed as the initial value on the command line.
- The cursor on the command line is displayed next to the data indicated as the initial value, and you can edit the data.
- When the cursor is shown by the mark "■", the replace mode takes effect. When the cursor is shown by the mark "_", the insert mode is effective.

Enter a desired value to the command line, using alphanumeric keys, → key, and ← key. Then the following display appears.

```

      P O I N T                X           Y           Z
↑  P O I N T 0 0 0 0 3 =      1 0 0 ,      1 0 0 ,      1 0 0 ,
   P O I N T 0 0 0 0 4 =      2 0 0 ,      2 0 0 ,      2 0 0 ,
   P O I N T 5 5 5 5 5 =      3 0 0 ,      3 0 0 ,      3 0 0 ,
   P O I N T 0 0 0 0 6 =      4 0 0 ,      4 0 0 ,      4 0 0 ,
↓  P O I N T 0 0 0 0 7 =      5 0 0 ,      5 0 0 ,      5 0 0 ,
3 3 3 _                               w / . w o r l d
SAVE PRG FULL TRANS PYLD >
    
```

Keys operative in the command line input mode and their operations are shown below.

Key	Descriptions
	Used to move the cursor left on the command line.
	Used to move the cursor right on the command line.
Numeral 	Used to input characters on the command line.
EXE	Used to change current position element to an entered one. The system returns to the position directory display mode with the main cursor moved to the next data column.
INS	Used to select the insert or replace mode for the command line.
BS	Used to delete one (1) character just before the cursor position on the command line.
ALT + BS	Used to delete one (1) character at the cursor position on the command line.
ESC	This function works in a different manner according to the presence or absence of input character(s). Presence of input character(s): All input character(s) on the command line are cleared. Absence of input character(s): The system returns to the positional data directory display.

Press the EXE key, and the position element is replaced by the newly specified data. The system returns to the positional data directory display mode with the main cursor moved to the next data column. The following display appears.

	P O I N T	X	Y	Z						
↑	P O I N T 0 0 0 0 3 =	1 0 0 ,	1 0 0 ,	1 0 0 ,						
	P O I N T 0 0 0 0 4 =	2 0 0 ,	2 0 0 ,	2 0 0 ,						
	P O I N T 5 5 5 5 5 =	3 3 3 ,	3 0 0 ,	3 0 0 ,						
	P O I N T 0 0 0 0 6 =	4 0 0 ,	4 0 0 ,	4 0 0 ,						
↓	P O I N T 0 0 0 0 7 =	5 0 0 ,	5 0 0 ,	5 0 0 ,						
3 0 0 _ w / . w o r l d										
<table border="1" style="width:100%; text-align:center;"> <tr> <td>SAVE</td> <td>PRG</td> <td>FULL</td> <td>TRANS</td> <td>PYLD</td> <td>></td> </tr> </table>					SAVE	PRG	FULL	TRANS	PYLD	>
SAVE	PRG	FULL	TRANS	PYLD	>					

- The main cursor moves to the next data column. When you have edited the CONFIG data, however, the cursor will not move.
- If the input data is illegal, a message saying "ILLEGAL DATA" is displayed on the command line and no data is changed. Press any key, and the system returns to the element editing mode.

(3) Caution

When the CONFIG data is edited, only the first character of the data can be edited.

The relationship between the input character and the set value is shown below.

Input character	Set value
F or 0	FREE
R or 1	RIGHT
L or 2	LEFTY

5.2.3 Addition of New Positional Data (INS)

(1) Function

Adds a new positional data.

(2) Procedures

Assume that you are going to add a new positional data ("POINT00011") just after "POINT00005."

(a) Step 1: Selection of position to create positional data.

Move the main cursor to "POINT00005", and the following display is called.

	P O I N T	X	Y	Z
↑	P O I N T 0 0 0 0 3 =	1 0 0 ,	1 0 0 ,	1 0 0 ,
	P O I N T 0 0 0 0 4 =	2 0 0 ,	2 0 0 ,	2 0 0 ,
	P O I N T 0 0 0 0 5 =	3 0 0 ,	3 0 0 ,	3 0 0 ,
	P O I N T 0 0 0 0 6 =	4 0 0 ,	4 0 0 ,	4 0 0 ,
↓	P O I N T 0 0 0 0 7 =	5 0 0 ,	5 0 0 ,	5 0 0 ,
P O I N T 0 0 0 0 5 w / . w o r l d				
SAVE PRG FULL TRANS PYLD >				

(b) Step 2: Positional data name input.

Press the INS key, and the display changes as shown below with the name input mode selected.

	P O I N T	X	Y	Z
↑	P O I N T 0 0 0 0 3 =	1 0 0 ,	1 0 0 ,	1 0 0 ,
	P O I N T 0 0 0 0 4 =	2 0 0 ,	2 0 0 ,	2 0 0 ,
	P O I N T 0 0 0 0 5 =	3 0 0 ,	3 0 0 ,	3 0 0 ,
	 =	0 ,	0 ,	0 ,
↓	P O I N T 0 0 0 0 6 =	4 0 0 ,	4 0 0 ,	4 0 0 ,
- w / . w o r l d				
SAVE PRG FULL TRANS PYLD >				

Enter a desired name ("POINT00011") and press the EXE key, as already described in Para. 5.2. The display changes as follows:

	P O I N T	X	Y	Z
↑	P O I N T 0 0 0 0 3 =	1 0 0 ,	1 0 0 ,	1 0 0 ,
	P O I N T 0 0 0 0 4 =	2 0 0 ,	2 0 0 ,	2 0 0 ,
	P O I N T 0 0 0 0 5 =	3 0 0 ,	3 0 0 ,	3 0 0 ,
	P O I N T 0 0 0 1 1 =	0 ,	0 ,	0 ,
↓	P O I N T 0 0 0 0 6 =	4 0 0 ,	4 0 0 ,	4 0 0 ,
0	w / . w o r l d			
	S A V E	P R G	F U L L	T R A N S P Y L D >

(3) Cautions

- For the newly added positional data, zero (0) is set for all elements.
- When you have pressed the ESC key without specifying the name, addition of the new data is canceled and the system returns.

5.2.4 Deletion of Positional Data (ALT + BS)

(1) Function

Deletes a positional data.

(2) Procedures

Assume that you are going to delete the data of "POINT00005".

(a) Step 1: Selection of positional data.

Move the main cursor to "POINT00005", and the following display is called.

	P O I N T	X	Y	Z
↑	P O I N T 0 0 0 0 3 =	1 0 0 ,	1 0 0 ,	1 0 0 ,
	P O I N T 0 0 0 0 4 =	2 0 0 ,	2 0 0 ,	2 0 0 ,
	P O I N T 0 0 0 0 5 =	3 0 0 ,	3 0 0 ,	3 0 0 ,
	P O I N T 0 0 0 0 6 =	4 0 0 ,	4 0 0 ,	4 0 0 ,
↓	P O I N T 0 0 0 0 7 =	5 0 0 ,	5 0 0 ,	5 0 0 ,
P O I N T 0 0 0 0 5 w / . w o r l d				
SAVE PRG FULL TRANS PYLD >				

(b) Step 2: Deletion.

Press the ALT and BS keys at the same time, and the following display appears with the specified data deleted.

	P O I N T	X	Y	Z
↑	P O I N T 0 0 0 0 3 =	1 0 0 ,	1 0 0 ,	1 0 0 ,
	P O I N T 0 0 0 0 4 =	2 0 0 ,	2 0 0 ,	2 0 0 ,
	P O I N T 0 0 0 0 6 =	4 0 0 ,	4 0 0 ,	4 0 0 ,
	P O I N T 0 0 0 0 7 =	5 0 0 ,	5 0 0 ,	5 0 0 ,
↓	P O I N T 0 0 0 0 8 =	8 0 0 ,	8 0 0 ,	8 0 0 ,
P O I N T 0 0 0 0 6 w / . w o r l d				
SAVE PRG FULL TRANS PYLD >				

(3) Caution

Different from the [CUT] function, you cannot undo a data deleted by this operation.

5.2.5 Quitting Data Editing [SAVE]

(1) Function

Saves an edited data in a file and quits editing data.

(2) Procedures

(a) Step 1: Save data.

Select the data display mode as shown below (i.e., the cursor is not present on the command line).

	P O I N T	X	Y	Z
↑	P O I N T 0 0 0 0 3 =	1 0 0 ,	1 0 0 ,	1 0 0 ,
	P O I N T 0 0 0 0 4 =	2 0 0 ,	2 0 0 ,	2 0 0 ,
	P O I N T 0 0 0 0 5 =	3 0 0 ,	3 0 0 ,	3 0 0 ,
	P O I N T 0 0 0 0 6 =	4 0 0 ,	4 0 0 ,	4 0 0 ,
↓	P O I N T 0 0 0 0 7 =	5 0 0 ,	5 0 0 ,	5 0 0 ,
P O I N T 0 0 0 0 5 w / . w o r l d				
SAVE PRG FULL TRANS PYLD >				

Press [SAVE], and the system asks with a confirmation message if you wish to save the edited data.

	P O I N T	X	Y	Z
↑	P O I N T 0 0 0 0 3 =	1 0 0 ,	1 0 0 ,	1 0 0 ,
	P O I N T 0 0 0 0 4 =	2 0 0 ,	2 0 0 ,	2 0 0 ,
	P O I N T 0 0 0 0 5 =	3 0 0 ,	3 0 0 ,	3 0 0 ,
	P O I N T 0 0 0 0 6 =	4 0 0 ,	4 0 0 ,	4 0 0 ,
↓	P O I N T 0 0 0 0 7 =	5 0 0 ,	5 0 0 ,	5 0 0 ,
[S A V E] O K T H E N < E X E > w / . w o r l d				
SAVE PRG FULL TRANS PYLD >				

(b) Step 2: Completes save.

Press the EXE key, and the system returns to the basic display as shown below.

M O D E : T E A C H I N G / C O N T	
	L : O : 2 0 % M : F R E E S : S T O P R E S E T
E D I T	D E D I T
S E L C T	
	F I L E
	>

To cancel this function, press the ESC key. You can then continue editing.

(3) Cautions

- When the data editor was started up from the program editor, the latter editor also terminates after saving the program in the file.
- In the data change mode (i.e., state where the cursor is on the command line), the keys may be inoperative even if pressed. When this happens, select the data display mode first, then press the keys.

5.2.6 Abortion and Quitting Data Editing [NOSAVE]

(1) Function

Aborts an edited data without saving it in a file and quits editing data.

(2) Procedures

(a) Step 1: Abortion of data editing.

Select the data display mode as shown below (i.e., the cursor is not present on the command line), and press the NEXT key repeatedly until [NOSAV] is displayed in the command menu.

	P O I N T	X	Y	Z
↑	P O I N T 0 0 0 0 3 =	1 0 0 ,	1 0 0 ,	1 0 0 ,
	P O I N T 0 0 0 0 4 =	2 0 0 ,	2 0 0 ,	2 0 0 ,
	P O I N T 0 0 0 0 5 =	3 0 0 ,	3 0 0 ,	3 0 0 ,
	P O I N T 0 0 0 0 6 =	4 0 0 ,	4 0 0 ,	4 0 0 ,
↓	P O I N T 0 0 0 0 7 =	5 0 0 ,	5 0 0 ,	5 0 0 ,
P O I N T 0 0 0 0 5 w / . w o r l d				
< N O S A V F I N D T E A C H M - T O C U T >				

Press [NOSAV], and the system asks with a confirmation message if you wish to abort the edited data.

	P O I N T	X	Y	Z
↑	P O I N T 0 0 0 0 3 =	1 0 0 ,	1 0 0 ,	1 0 0 ,
	P O I N T 0 0 0 0 4 =	2 0 0 ,	2 0 0 ,	2 0 0 ,
	P O I N T 0 0 0 0 5 =	3 0 0 ,	3 0 0 ,	3 0 0 ,
	P O I N T 0 0 0 0 6 =	4 0 0 ,	4 0 0 ,	4 0 0 ,
↓	P O I N T 0 0 0 0 7 =	5 0 0 ,	5 0 0 ,	5 0 0 ,
[N O S A V E] O K T H E N < E X E > w / . w o r l d				
< N O S A V F I N D T E A C H M - T O C U T >				

(b) Step 2: Abortion and completion of data editing.

Press the EXE key, and the system returns to the basic display as shown below.

M O D E : T E A C H I N G / C O N T	
	L : O : 2 0 % M : F R E E S : S T O P R E S E T
EDIT	DEDIT
SELCT	FILE
	>

To cancel this function, press the ESC key. You can continue editing then.

(3) Cautions

- When the data editor was started up from the program editor, the latter editor also terminates without saving the program in the file.
- In the data change mode (i.e., state where the cursor is on the command line), the keys may be inoperative even if pressed. When this happens, select the data display mode first, then press the keys.

5.2.7 Return to Program Editor [PRG]

(1) Function

When the data editor was started from the program editor, the system returns to the program editing mode. At this point of time, edited data is not saved in the file. (The edited data remains.)

If the data editor was started from the basic menu, this function is inoperative.

(2) Procedures

(a) Step 1: Command selection.

Select the data display mode as shown below (i.e., the cursor is not present on the command line).

	P O I N T	X	Y	Z
↑	P O I N T 0 0 0 0 3 =	1 0 0 ,	1 0 0 ,	1 0 0 ,
	P O I N T 0 0 0 0 4 =	2 0 0 ,	2 0 0 ,	2 0 0 ,
	P O I N T 0 0 0 0 5 =	3 0 0 ,	3 0 0 ,	3 0 0 ,
	P O I N T 0 0 0 0 6 =	4 0 0 ,	4 0 0 ,	4 0 0 ,
↓	P O I N T 0 0 0 0 7 =	5 0 0 ,	5 0 0 ,	5 0 0 ,
P O I N T 0 0 0 0 5 w / . w o r l d				
SAVE PRG FULL TRANS PYLD >				

Press [PRG], and the system returns to the following program editing display.

	T E S T	C : 1	L : 1
<u>P</u>	P R O G R A M T E S T		
	M O V E P O I N T 0 0 0 0 1		
	M O V E P O I N T 0 0 0 0 2		
	E N D		
SAVE DEDIT JUMP FIND CHANG >			

(3) Cautions

- When the data editor was started up from the basic menu, this function becomes invalid.
- In the data change mode (i.e., state where the cursor is on the command line), the keys may be inoperative even if pressed. When this happens, select the data display mode first, then press the keys.

5.2.8 Call of Detailed Positional Data Display [FULL]

(1) Function

Displays the detailed positional data display.

(2) Procedures

Assume that you are going to display the data of "POINT00005" in detail.

(a) Step 1: Command selection.

Move the main cursor to "POINT00005", and the following display appears.

	P O I N T	X	Y	Z
↑	P O I N T 0 0 0 0 3 =	1 0 0 ,	1 0 0 ,	1 0 0 ,
	P O I N T 0 0 0 0 4 =	2 0 0 ,	2 0 0 ,	2 0 0 ,
	P O I N T 0 0 0 0 5 =	3 0 0 ,	3 0 0 ,	3 0 0 ,
	P O I N T 0 0 0 0 6 =	4 0 0 ,	4 0 0 ,	4 0 0 ,
↓	P O I N T 0 0 0 0 7 =	5 0 0 ,	5 0 0 ,	5 0 0 ,
P O I N T 0 0 0 0 5 w / . w o r l d				
SAVE PRG FULL TRANS PYLD >				

Press [FULL] and the following detailed display is called.

P O I N T 0 0 0 0 5	[5 / 1 0]
X :	3 0 0 . 0 0 0 C O N F I G : F R E E
Y :	3 0 0 . 0 0 0
Z :	3 0 0 . 0 0 0
C :	3 0 0 . 0 0 0
T :	3 0 0 . 0 0 0
P O I N T 0 0 0 0 5 w / . w o r l d	
SAVE PRG DIR TRANS PYLD >	

(3) Caution

Even if the main cursor is located under the column of a data element you wish to display in detail, the detailed display appears as well.

For details of operations to be done on the detailed display, see Para. 5.3.

5.2.9 Call of Coordinate Data Directory Display [TRANS]

(1) Function

Calls the coordinate data directory display.

(2) Procedures

(a) Step 1: Command selection.

Press the NEXT key until [FULL] display appears.

	P O I N T	X	Y	Z
↑	P O I N T 0 0 0 0 3 =	1 0 0 ,	1 0 0 ,	1 0 0 ,
	P O I N T 0 0 0 0 4 =	2 0 0 ,	2 0 0 ,	2 0 0 ,
	P O I N T 0 0 0 0 5 =	3 0 0 ,	3 0 0 ,	3 0 0 ,
	P O I N T 0 0 0 0 6 =	4 0 0 ,	4 0 0 ,	4 0 0 ,
↓	P O I N T 0 0 0 0 7 =	5 0 0 ,	5 0 0 ,	5 0 0 ,
P O I N T 0 0 0 0 5 w / . w o r l d				
S A V E P R G F U L L T R A N S P Y L D >				

Press [TRANS], and the following coordinate data directory display appears.

T R A N S	S E L E C T I O N	[1 /	1 0]
. w o r l d			1 0	
T R A N S 0 0 0 0 4			1 0	
T R A N S 0 0 0 0 5			5	
T R A N S 0 0 0 0 7			0	
T R A N S 0 0 0 0 8			0	
S A V E P R G W O R K T O O L >				

(3) Caution

On the coordinate data directory display, the main cursor indicates a coordinate system to which the positional data belongs.

For details of operations to be done on the coordinate data display, see Para. 5.4.

5.2.10 Call of Load Data Directory Display [PYLD]

(1) Function

Calls the load data directory display.

(2) Procedures

(a) Step 1: Command selection.

Press the NEXT key until [PYLD] display appears.

	P O I N T	X	Y	Z
↑	P O I N T 0 0 0 0 3 =	1 0 0 ,	1 0 0 ,	1 0 0 ,
	P O I N T 0 0 0 0 4 =	2 0 0 ,	2 0 0 ,	2 0 0 ,
	P O I N T 0 0 0 0 5 =	3 0 0 ,	3 0 0 ,	3 0 0 ,
	P O I N T 0 0 0 0 6 =	4 0 0 ,	4 0 0 ,	4 0 0 ,
↓	P O I N T 0 0 0 0 7 =	5 0 0 ,	5 0 0 ,	5 0 0 ,
P O I N T 0 0 0 0 5 w / . w o r l d				
SAVE PRG FULL TRANS PYLD >				

Press [PYLD], and the following load data directory display appears.

	P L O A D	W E I G H T	O F F S E T
↑	L O A D 0 0 0 0 0 3 =	1 0 0 . 0 0 0 ,	1 0 0 . 0 0 0
	L O A D 0 0 0 0 0 4 =	0 . 0 0 0 ,	0 . 0 0 0
	L O A D 0 0 0 0 0 5 =	0 . 0 0 0 ,	0 . 0 0 0
	L O A D 0 0 0 0 0 6 =	0 . 0 0 0 ,	0 . 0 0 0
↓	L O A D 0 0 0 0 0 7 =	0 . 0 0 0 ,	0 . 0 0 0
L O A D 0 0 0 0 0 3			
SAVE PRG POINT TRANS FIND >			

(3) Caution

On the load data directory display, the main cursor indicates the position of the data displayed before. At initial display, the data are displayed from the beginning.

For details of operations to be done on the load data display, see Para. 5.6.

5.2.11 Search of Positional Data [FIND]

(1) Function

Searches the data bearing the specified position name.

(2) Procedures

Assume that you are going to search the positional data named "POINT00008."

(a) Step 1: Command selection.

Press the NEXT key repeatedly until [FIND] is displayed in the soft key menu.

	P O I N T	X	Y	Z
↑	P O I N T 0 0 0 0 3 =	1 0 0 ,	1 0 0 ,	1 0 0 ,
	P O I N T 0 0 0 0 4 =	2 0 0 ,	2 0 0 ,	2 0 0 ,
	P O I N T 0 0 0 0 5 =	3 0 0 ,	3 0 0 ,	3 0 0 ,
	P O I N T 0 0 0 0 6 =	4 0 0 ,	4 0 0 ,	4 0 0 ,
↓	P O I N T 0 0 0 0 7 =	5 0 0 ,	5 0 0 ,	5 0 0 ,
P O I N T 0 0 0 0 5 w / . w o r l d				
< N O S A V F I N D T E A C H M - T O C U T >				

Press [FIND], and the following display appears.

	P O I N T	X	Y	Z
↑	P O I N T 0 0 0 0 3 =	1 0 0 ,	1 0 0 ,	1 0 0 ,
	P O I N T 0 0 0 0 4 =	2 0 0 ,	2 0 0 ,	2 0 0 ,
	P O I N T 0 0 0 0 5 =	3 0 0 ,	3 0 0 ,	3 0 0 ,
	P O I N T 0 0 0 0 6 =	4 0 0 ,	4 0 0 ,	4 0 0 ,
↓	P O I N T 0 0 0 0 7 =	5 0 0 ,	5 0 0 ,	5 0 0 ,
F I N D : _ w / . w o r l d				

(b) Step 2: Search data name input.

Enter "POINT00008", and the display is changed over as shown below.

	P O I N T	X	Y	Z
↑	P O I N T 0 0 0 0 3 =	1 0 0 ,	1 0 0 ,	1 0 0 ,
	P O I N T 0 0 0 0 4 =	2 0 0 ,	2 0 0 ,	2 0 0 ,
	P O I N T 0 0 0 0 5 =	3 0 0 ,	3 0 0 ,	3 0 0 ,
	P O I N T 0 0 0 0 6 =	4 0 0 ,	4 0 0 ,	4 0 0 ,
↓	P O I N T 0 0 0 0 7 =	5 0 0 ,	5 0 0 ,	5 0 0 ,
F I N D : P O I N T 0 0 0 0 8 _ w / . w o r l d				

Keys operative in this mode and their operations are shown below.

Key	Descriptions
	Used to move the cursor left on the command line.
	Used to move the cursor right on the command line.
<div style="border: 1px solid black; padding: 2px; display: inline-block;">Numeral</div> <div style="border: 1px solid black; padding: 2px; display: inline-block;">Alphabet</div>	Used to input characters on the command line.
<div style="border: 1px solid black; padding: 2px; display: inline-block;">EXE</div>	Used to search the specified position name and return the system to the positional data directory display. Unless the specified data is present, a message saying "ERR: ILLEGAL NAME" is displayed on the command line.
<div style="border: 1px solid black; padding: 2px; display: inline-block;">INS</div>	Used to select the insert or replace mode for the command line.
<div style="border: 1px solid black; padding: 2px; display: inline-block;">BS</div>	Used to delete one (1) character just before the cursor position on the command line.
<div style="border: 1px solid black; padding: 2px; display: inline-block;">ALT</div> + <div style="border: 1px solid black; padding: 2px; display: inline-block;">BS</div>	Used to delete one (1) character at the cursor position on the command line.
<div style="border: 1px solid black; padding: 2px; display: inline-block;">ESC</div>	This function works in a different manner according to the presence or absence of input character(s). Presence of input character(s): All input character(s) on the command line are cleared. Absence of input character(s): The system returns to the positional data directory display.

(c) Step 3: Search execution.

Press the EXE key, and search of the specified position name starts. If found, the positional data directory is displayed with the specified data at the head of the screen and the main cursor moved there. The display is as shown below.

	P O I N T	X	Y	Z
↑	P O I N T 0 0 0 0 8 =	8 0 0 ,	8 0 0 ,	8 0 0 ,
	P O I N T 0 0 0 0 9 =	9 0 0 ,	9 0 0 ,	9 0 0 ,
	P O I N T 0 0 0 1 0 =	0 ,	0 ,	0 ,
<div style="display: flex; justify-content: space-between; align-items: center;"> P O I N T 0 0 0 0 8 w / . w o r l d </div> <div style="display: flex; justify-content: space-between; align-items: center; margin-top: 5px;"> < N O S A V F I N D T E A C H M - T O C U T > </div>				

(3) Cautions

- Unless the specified name exists, the system returns to the previous directory display with a message of "ERR: ILLEGAL NAME" shown on the command line.
- As the search is performed throughout the file, the search start position is unrelated to the search operation.

5.2.12 Teach of Positional Data [TEACH]

- (1) Function
Guides the robot tool tip to the teach point, then registers the current position of the robot in the positional data indicated by the main cursor.
- (2) Procedures
Assume that you are going to teach the current position of the robot in the positional data of "POINT00005."
- (a) Step 1: Command selection.
Guide the robot tool tip to the teach point.



CAUTION

In principle, the teaching operation should be performed outside the dangerous area of the robot. If it should be performed inevitably within the dangerous area, strictly observe the following matters.

- (1) The teaching operation should always be performed by two (2) persons. One person performs the job and the other person watches outside the dangerous area. Also, both persons should try to prevent mis-operation with each other.
- (2) The operator should do the job in an attitude ready to press the EMERGENCY stop pushbutton switch at any time. Also, he should perform the job at a position from which he can evacuate immediately at the time of emergency after confirming the robot working range and shields nearby.
- (3) The supervisor should keep watch on the job at a position where he can see the entire robot system and operate the EMERGENCY stop pushbutton switch at the time of an emergency. Also, he should keep anyone from entering the dangerous area.

Move the main cursor to "POINT00005", then press the NEXT key repeatedly until [TEACH] is displayed in the menu.

	P O I N T	X	Y	Z
↑	P O I N T 0 0 0 0 3 =	1 0 0 ,	1 0 0 ,	1 0 0 ,
	P O I N T 0 0 0 0 4 =	2 0 0 ,	2 0 0 ,	2 0 0 ,
	P O I N T 0 0 0 0 5 =	3 0 0 ,	3 0 0 ,	3 0 0 ,
	P O I N T 0 0 0 0 6 =	4 0 0 ,	4 0 0 ,	4 0 0 ,
↓	P O I N T 0 0 0 0 7 =	5 0 0 ,	5 0 0 ,	5 0 0 ,
P O I N T 0 0 0 0 5 w / . w o r l d				
<	N O S A V	F I N D	T E A C H	M - T O C U T >

Press [TEACH].

	P O I N T	X	Y	Z
↑	P O I N T 0 0 0 0 3 =	1 0 0 ,	1 0 0 ,	1 0 0 ,
	P O I N T 0 0 0 0 4 =	2 0 0 ,	2 0 0 ,	2 0 0 ,
	P O I N T 0 0 0 0 5 =	3 0 0 ,	3 0 0 ,	3 0 0 ,
	P O I N T 0 0 0 0 6 =	4 0 0 ,	4 0 0 ,	4 0 0 ,
↓	P O I N T 0 0 0 0 7 =	5 0 0 ,	5 0 0 ,	5 0 0 ,
T E A C H : P R E S S < E X E > w / . w o r l d				

To input a positional data, press the EXE key. (To stop, press the ESC key.)
 When the robot current position is as shown below, the following display appears.

```

X      100.0
Y      0
Z      0
C      0
T      0
CONFIG FREE
    
```

	P O I N T	X	Y	Z
↑	P O I N T 0 0 0 0 3 =	1 0 0 ,	1 0 0 ,	1 0 0 ,
	P O I N T 0 0 0 0 4 =	2 0 0 ,	2 0 0 ,	2 0 0 ,
	P O I N T 0 0 0 0 5 =	1 0 0 ,	0 ,	0 ,
	P O I N T 0 0 0 0 6 =	4 0 0 ,	4 0 0 ,	4 0 0 ,
↓	P O I N T 0 0 0 0 7 =	5 0 0 ,	5 0 0 ,	5 0 0 ,
P O I N T 0 0 0 0 5 w / . w o r l d				
< N O S A V F I N D T E A C H M - T O C U T >				

(3) Cautions

- The main cursor will not move even after finishing teaching.
- Unless actually used tool coincides with tool coordinate data selected, we cannot guarantee the tool tip position at program execution.

5.2.13 Move to Teach Point [M-TO]

(1) Function

Moves the robot to a position of the positional data indicated by the main cursor by synchronous operation.

(2) Procedures

Assume that you are going to move the robot to the position of "POINT00005."

(a) Step 1: Command selection.

Move the main cursor to "POINT00005" and press the NEXT key repeatedly until [M-TO] is displayed in the command menu.

	P O I N T	X	Y	Z
↑	P O I N T 0 0 0 0 3 =	1 0 0 ,	1 0 0 ,	1 0 0 ,
	P O I N T 0 0 0 0 4 =	2 0 0 ,	2 0 0 ,	2 0 0 ,
	P O I N T 0 0 0 0 5 =	3 0 0 ,	3 0 0 ,	3 0 0 ,
	P O I N T 0 0 0 0 6 =	4 0 0 ,	4 0 0 ,	4 0 0 ,
↓	P O I N T 0 0 0 0 7 =	5 0 0 ,	5 0 0 ,	5 0 0 ,
P O I N T 0 0 0 0 5 w / . w o r l d				
<	N O S A V	F I N D	T E A C H	M - T O
			C U T	>

Press [M-TO].

	P O I N T	X	Y	Z
↑	P O I N T 0 0 0 0 3 =	1 0 0 ,	1 0 0 ,	1 0 0 ,
	P O I N T 0 0 0 0 4 =	2 0 0 ,	2 0 0 ,	2 0 0 ,
	P O I N T 0 0 0 0 5 =	3 0 0 ,	3 0 0 ,	3 0 0 ,
	P O I N T 0 0 0 0 6 =	4 0 0 ,	4 0 0 ,	4 0 0 ,
↓	P O I N T 0 0 0 0 7 =	5 0 0 ,	5 0 0 ,	5 0 0 ,
M O V I N G T O P O I N T				

(b) Step 2: Command execution.

Press the MOVE key while pressing the enable switch, and the robot moves to the teach point in synchronism. When the robot has reached the teach point, the system returns to the previous display.

(3) Cautions

- This function is useful when you set the next teach point based on the current teach point. If you have released the MOVE key or enable switch while the robot was moving, or if you have pressed the FEED HOLD key, the robot will decelerate and stop.
- If the FEED HOLD key is canceled while you were pressing the MOVE key in the feed hold mode, the robot will resume an operation.

5.2.14 Cut of Positional Data [CUT]

(1) Function

Cuts multiple positional data simultaneously.

(2) Procedures

Assume that you are going to cut the positional data of "POINT00004" ~ "POINT00005".

(a) Step 1: Command selection.

Move the main cursor to "POINT00004" and press the NEXT key repeatedly until [CUT] is displayed in the command menu.

	P O I N T	X	Y	Z
↑	P O I N T 0 0 0 0 3 =	1 0 0 ,	1 0 0 ,	1 0 0 ,
	P O I N T 0 0 0 0 4 =	2 0 0 ,	2 0 0 ,	2 0 0 ,
	P O I N T 0 0 0 0 5 =	3 0 0 ,	3 0 0 ,	3 0 0 ,
	P O I N T 0 0 0 0 6 =	4 0 0 ,	4 0 0 ,	4 0 0 ,
↓	P O I N T 0 0 0 0 7 =	5 0 0 ,	5 0 0 ,	5 0 0 ,
P O I N T 0 0 0 0 4 w / . w o r l d				
<	N O S A V	F I N D	T E A C H	M - T O C U T >

Press [CUT], and the entire data at the main cursor position is displayed in a reversed image to indicate that it is selected. The display is as shown below.

	P O I N T	X	Y	Z
↑	P O I N T 0 0 0 0 3 =	1 0 0 ,	1 0 0 ,	1 0 0 ,
	P O I N T 0 0 0 0 4 =	2 0 0 ,	2 0 0 ,	2 0 0 ,
	P O I N T 0 0 0 0 5 =	3 0 0 ,	3 0 0 ,	3 0 0 ,
	P O I N T 0 0 0 0 6 =	4 0 0 ,	4 0 0 ,	4 0 0 ,
↓	P O I N T 0 0 0 0 7 =	5 0 0 ,	5 0 0 ,	5 0 0 ,
P O I N T 0 0 0 0 4 w / . w o r l d				
				C U T

The entire data selected is displayed inversely.

Keys operative in this mode and their operations are shown below.

Key	Descriptions
↑	Used to widen the selection range upward.
↓	Used to widen the selection range downward.
[ALT] + ↑	Used to widen the selection range upward on the screen basis.
[ALT] + ↓	Used to widen the selection range downward on the screen basis.
[ESC]	Cancels the range selection and returns the system to the positional data directory display mode.

Operation of the command menu is shown below.

Menu	Descriptions
[CUT]	Used to save the data in the selection range in the cut buffer and delete that data.

(b) Step 2: Cut.

Move the main cursor by means of the ↓ key to change the selection range. The following display then appears.

	P O I N T	X	Y	Z
↑	P O I N T 0 0 0 0 3 =	1 0 0 ,	1 0 0 ,	1 0 0 ,
	P O I N T 0 0 0 0 4 =	2 0 0 ,	2 0 0 ,	2 0 0 ,
	P O I N T 0 0 0 0 5 =	3 0 0 ,	3 0 0 ,	3 0 0 ,
	P O I N T 0 0 0 0 6 =	4 0 0 ,	4 0 0 ,	4 0 0 ,
↓	P O I N T 0 0 0 0 7 =	5 0 0 ,	5 0 0 ,	5 0 0 ,
	P O I N T 0 0 0 0 5	w / . w o r l d		
				C U T

Press [CUT] to cut the selected data at once. The display changes over as shown below.

	P O I N T	X	Y	Z
↑	P O I N T 0 0 0 0 3 =	1 0 0 ,	1 0 0 ,	1 0 0 ,
	P O I N T 0 0 0 0 6 =	4 0 0 ,	4 0 0 ,	4 0 0 ,
	P O I N T 0 0 0 0 7 =	5 0 0 ,	5 0 0 ,	5 0 0 ,
	P O I N T 0 0 0 0 8 =	0 ,	0 ,	0 ,
↓	P O I N T 0 0 0 0 9 =	0 ,	0 ,	0 ,
P O I N T 0 0 0 0 6		w / . w o r l d		
<	N O S A V	F I N D	T E A C H	M - T O
			C U T	>

(3) Caution

When this cut function is used, cut data can be saved in the cut buffer and pasted at another position by means of the paste function stated in the next paragraph.

5.2.15 Paste of Positional Data [PASTE]

(1) Function

Pastes multiple positional data cut by the cut function at another position.

(2) Procedures

Assume that you are going to paste the cut data (POINT00004 ~ POINT00005) after "POINT00007."

(a) Step 1: Command selection.

Move the main cursor to "POINT00007" and press the NEXT key repeatedly until [PASTE] is displayed in the command menu.

	P O I N T	X	Y	Z
↑	P O I N T 0 0 0 0 3 =	1 0 0 ,	1 0 0 ,	1 0 0 ,
	P O I N T 0 0 0 0 6 =	4 0 0 ,	4 0 0 ,	4 0 0 ,
	P O I N T 0 0 0 0 7 =	5 0 0 ,	5 0 0 ,	5 0 0 ,
	P O I N T 0 0 0 0 8 =	0 ,	0 ,	0 ,
↓	P O I N T 0 0 0 0 9 =	0 ,	0 ,	0 ,
P O I N T 0 0 0 0 7		w / . w o r l d		
<	P A S T E			

(b) Step 2: Paste.

Press [PASTE], and the cut data is pasted. The display is as shown below.

	P O I N T	X	Y	Z
↑	P O I N T 0 0 0 0 3 =	1 0 0 ,	1 0 0 ,	1 0 0 ,
	P O I N T 0 0 0 0 6 =	4 0 0 ,	4 0 0 ,	4 0 0 ,
	P O I N T 0 0 0 0 7 =	5 0 0 ,	5 0 0 ,	5 0 0 ,
	P O I N T 0 0 0 0 4 =	2 0 0 ,	2 0 0 ,	2 0 0 ,
↓	P O I N T 0 0 0 0 5 =	3 0 0 ,	3 0 0 ,	3 0 0 ,
P O I N T 0 0 0 0 7		w / . w o r l d		
<	P A S T E			

(3) Caution

Cut data can be pasted under the main cursor.

5.2.16 Move to Teach Point [BYPAS]

When moving directly to the teach point using the M-TO (Move to Teach Point) function, there is a danger of interference with the workpiece along the path. To prevent this, the BYPASS function retracts the hand in the +Z direction (upward direction), moves to the space above the target position, and then moves to the target position.

(1) Parameter settings

```
[U23] Bypass function parameter
{ Function enable SW (0:Disable, 1:M-to & Bypass,
2:Bypass ) ←①
= 1
{ Retract position } ←②
= 0.0    0.0    200.0    0.0    0.0    0.0
{ Z Axis offset parameter } ←③
= 0.0    0.0
```

① BYPASS function Enable/Disable setting

```
{ Function enable SW }
= 1
0: M-TO/BYPASS disable
1: M-TO/BYPASS enable
2: M-TO disable/BYPASS enable
```

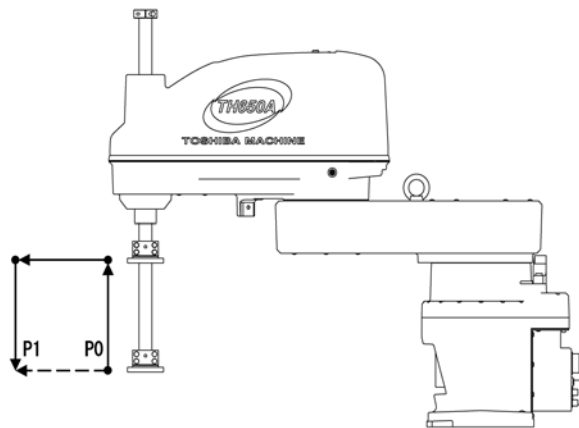

② Retract position parameter (for SCARA robot)

```
{ Retract position }
= 0.0  0.0  200.0  0.0  0.0  0.0
```

In the SCARA robot, the third value is entered as the absolute position. The other values are invalid even if they are defined.

③ Z-axis offset parameter (for Lcdr)

{ Z Axis offset parameter }

= 0.0 0.0

This parameter is for the Lcdr (glass transfer robot).

(2) Screen description

Note that the command keys displayed during data editing vary depending on the user parameter setting values.

① When [BYPASS function Enable/Disable setting] [U23] parameter = 0

P O I N T		X	Y	Z
↑	P O I N T 0 0 0 0 3	= 1 0 0 ,	1 0 0 ,	1 0 0 ,
	P O I N T 0 0 0 0 4	= 2 0 0 ,	2 0 0 ,	2 0 0 ,
	P O I N T 5 5 5 5 5	= 3 0 0 ,	3 0 0 ,	3 0 0 ,
	P O I N T 0 0 0 0 6	= 4 0 0 ,	4 0 0 ,	4 0 0 ,
↓	P O I N T 0 0 0 0 7	= 5 0 0 ,	5 0 0 ,	5 0 0 ,
3 0 0 . 1 2 3		w / . w o r l d		
< N O S A V		F I N D	T E A C H	M - T O
		C U T		>

*[M-TO] is displayed in the function menu.

② When [BYPASS function Enable/Disable setting] [U23] parameter = 1

P O I N T		X	Y	Z
↑	P O I N T 0 0 0 0 3	= 1 0 0 ,	1 0 0 ,	1 0 0 ,
	P O I N T 0 0 0 0 4	= 2 0 0 ,	2 0 0 ,	2 0 0 ,
	P O I N T 5 5 5 5 5	= 3 0 0 ,	3 0 0 ,	3 0 0 ,
	P O I N T 0 0 0 0 6	= 4 0 0 ,	4 0 0 ,	4 0 0 ,
↓	P O I N T 0 0 0 0 7	= 5 0 0 ,	5 0 0 ,	5 0 0 ,
3 0 0 . 1 2 3		w / . w o r l d		
S A V E		P R G	T E A C H	M - T O
		B Y P A S		>

*[M-TO] and [BYPASS] are displayed in the function menu.

③ When [BYPASS function Enable/Disable setting] [U23] parameter = 2

	P O I N T		X	Y	Z
↑	P O I N T 0 0 0 0 3	=	1 0 0 ,	1 0 0 ,	1 0 0 ,
	P O I N T 0 0 0 0 4	=	2 0 0 ,	2 0 0 ,	2 0 0 ,
	P O I N T 5 5 5 5 5	=	3 0 0 ,	3 0 0 ,	3 0 0 ,
	P O I N T 0 0 0 0 6	=	4 0 0 ,	4 0 0 ,	4 0 0 ,
↓	P O I N T 0 0 0 0 7	=	5 0 0 ,	5 0 0 ,	5 0 0 ,
3 0 0 . 1 2 3 w / . w o r l d					
SAVE PRG TEACH M—TO BYPAS >					

*[BYPASS] is displayed in the function menu.

(3) Procedures

① Use the cursor keys to select the point data where you want to perform the bypass operation.

	P O I N T		X	Y	Z
↑	P O I N T 0 0 0 0 3	=	1 0 0 ,	1 0 0 ,	1 0 0 ,
	P O I N T 0 0 0 0 4	=	2 0 0 ,	2 0 0 ,	2 0 0 ,
	P O I N T 5 5 5 5 5	=	3 0 0 ,	3 0 0 ,	3 0 0 ,
	P O I N T 0 0 0 0 6	=	4 0 0 ,	4 0 0 ,	4 0 0 ,
↓	P O I N T 0 0 0 0 7	=	5 0 0 ,	5 0 0 ,	5 0 0 ,
3 0 0 . 1 2 3 w / . w o r l d					
SAVE PRG TEACH M—TO BYPAS >					

② Press [BYPAS] to display the message "BY_MOVING TO POINT!".

③ While holding down the enable switch of the teach pendant, press the MOVE key to perform the operations (P0) → (P0a) → (P1b) → (P1) as shown in the figure below. (The PASS operation is not performed in each operation range.)

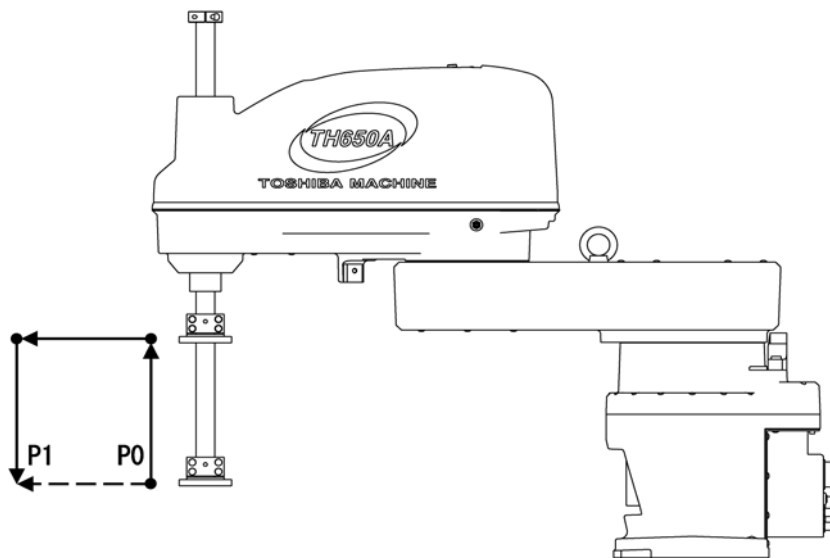

- A) Retraction movement from current position P0 to P0a: Move at P0 orientation (CONFIG)
 - B) Move parallel and rotate from position P0a to P1a: Move at P1 orientation (CONFIG)
 - C) Thrust movement from position P1a to P1: Move at P1 orientation (CONFIG)
- ④ When the MOVE key or enable switch is released, the robot stops temporarily.
- ⑤ Press the enable switch + MOVE key again to restart the remaining bypass operation.
- ⑥ Press the ESC key to end the bypass function.

5.3 Detailed Positional Data Display Mode

The detailed positional data directory display mode displays one (1) positional data on the full screen. In this mode, it is possible to add, delete, and edit the positional data.

An example of display is given below.







P	O	I	N	T	0	0	0	0	5	[5	/	1	0]																											
X	:	3	0	0	.	0	0	0		C	O	N	F	I	G	:	F	R	E	E																						
Y	:	3	0	0	.	0	0	0																																		
Z	:	3	0	0	.	0	0	0																																		
C	:	3	0	0	.	0	0	0																																		
T	:	3	0	0	.	0	0	0																																		
P	O	I	N	T	0	0	0	0	5	w	/	.	w	o	r	l	d																									
S	A	V	E							P	R	G						D	I	R						T	R	A	N	S				P	Y	L	D					>

Each time the NEXT key is pressed, the menu is changed over as follows:

N	O	S	A	V						F	I	N	D					T	E	A	C	H				M	-	T	O					>
---	---	---	---	---	--	--	--	--	--	---	---	---	---	--	--	--	--	---	---	---	---	---	--	--	--	---	---	---	---	--	--	--	--	---

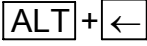
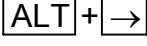
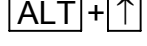
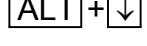
- An inversely displayed section in the data is called the "main cursor" which indicates that this data is selected for editing.
- For the data of [nnnn/mmmm] displayed on the 1st line, "nnnn" signifies the number of order where it is defined in a selected coordinate system. "mmm" represents the total number of positional data in a selected coordinate system.
- Data following "w/" on the right side of the command line identifies the coordinate data to which the selected positional data belongs.

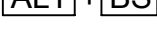
Keys operative in this mode and their operations are shown below.

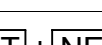
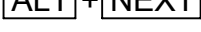
Key	Descriptions
	Used to move the main cursor to each data in the order of [Name ← X ← Y ← Z ← C ← T ← config ← Name].
	Used to move the main cursor to each data in the order of [Name → X → Y → Z → C → T → config → Name].
	Used to display detailed positional data in a coordinate system defined before.
	Used to display detailed positional data in a coordinate system defined after.
	Used to display the defined detailed positional data before current positional data.
	Used to display the defined detailed positional data after current positional data.
	Used to create a new positional data just after a current positional data.
	Used to delete a current positional data and display in detail the positional data defined next.
	Used to edit a data indicated by the main cursor.
	Used to toggle the menu (resulting in the next menu).
	Used to toggle the menu (resulting in the previous menu).

Operations of each command menu are shown below.

Menu	Descriptions
[SAVE]	Used to save a data and quit the data editor.
[PRG]	Used to select the program editor display. If the data editor was started up, however, the display will not change over.
[DIR]	Used to select the positional data directory display. For details, see Para. 5.2.
[TRANS]	Used to select the coordinate data editor display. For details, see Para. 5.4.
[PLOAD]	Used to select the load data editor display. For details, see Para. 5.6.
[NOSAV]	Used to quit the editor without saving data. All changed data are aborted.
[FIND]	Used to select the position name search mode.
[TEACH]	Used to teach a current position of the robot in a positional data indicated by the main cursor.
[M-TO]	Used to move the robot to a position indicated by the main cursor.

Each menu of [SAVE], [NOSAV], [PRG], [TRANS], [PLOAD], [FIND], [TEACH] and [M-TO] is the same as in the positional data directory display mode and is not described in this paragraph.

5.3.1 Editing of Detailed Positional Data Name

(1) Function

Edits a positional data name.

(2) Procedures

When you press the EXE key while the main cursor is located at the position name, you can edit the position name.

In the example below, assume that you are going to change the name of "POINT00005" to "POINT55555."

(a) Step 1: Data selection.

Move the main cursor to the data name by means of the cursor keys (↑, ↓), and the following display appears.

P	O	I	N	T	0	0	0	0	5	[5	/	1	0]				
X :	3	0	0	.	0	0	0	C	O	N	F	I	G	:	F	R	E	E	
Y :	3	0	0	.	0	0	0												
Z :	3	0	0	.	0	0	0												
C :	3	0	0	.	0	0	0												
T :	3	0	0	.	0	0	0												
P	O	I	N	T	0	0	0	0	5	w	/	.	w	o	r	l	d		
S	A	V	E	P	R	G	D	I	R	T	R	A	N	S	P	Y	L	D	>

Press the EXE key, and the following display is called. (The cursor is displayed on the command line.)

P	O	I	N	T	0	0	0	0	5	[5	/	1	0]				
X :	3	0	0	.	0	0	0	C	O	N	F	I	G	:	F	R	E	E	
Y :	3	0	0	.	0	0	0												
Z :	3	0	0	.	0	0	0												
C :	3	0	0	.	0	0	0												
T :	3	0	0	.	0	0	0												
P	O	I	N	T	0	0	0	0	5	w	/	.	w	o	r	l	d		
S	A	V	E	P	R	G	D	I	R	T	R	A	N	S	P	Y	L	D	>

- Current data is displayed as the initial value on the command line.
- The cursor on the command line is displayed next to the initially displayed name, and you can edit the data.
- When the cursor is shown by the mark "■", the replace mode takes effect. When the cursor is shown by the mark "_", the insert mode is effective.

(b) Step 2: Data editing.

Enter a desired name to the command line, using alphanumeric keys, → key, and ← key. Then the following display appears.

```

P O I N T 0 0 0 0 5 [ 5 / 1 0 ]
X : 3 0 0 . 0 0 0 C O N F I G : F R E E
Y : 3 0 0 . 0 0 0
Z : 3 0 0 . 0 0 0
C : 3 0 0 . 0 0 0
T : 3 0 0 . 0 0 0
P O I N T 5 5 5 5 5 _ w / . w o r l d
S A V E P R G D I R T R A N S P Y L D >
    
```

Keys operative in this mode and their operations are shown below.

Key	Descriptions
	Used to move the cursor left on the command line.
	Used to move the cursor right on the command line.
<div style="border: 1px solid black; padding: 2px; display: inline-block;">Numeral</div> <div style="border: 1px solid black; padding: 2px; display: inline-block;">Alphabet</div>	Used to input characters on the command line.
<div style="border: 1px solid black; padding: 2px; display: inline-block;">EXE</div>	Used to change current position name to an entered one. The system returns to the detailed positional data display mode with the cursor moved to the X-data area.
<div style="border: 1px solid black; padding: 2px; display: inline-block;">INS</div>	Used to select the insert or replace mode for the command line.
<div style="border: 1px solid black; padding: 2px; display: inline-block;">BS</div>	Used to delete one (1) character just before the cursor position on the command line.
<div style="border: 1px solid black; padding: 2px; display: inline-block;">ALT</div> + <div style="border: 1px solid black; padding: 2px; display: inline-block;">BS</div>	Used to delete one (1) character at the cursor position on the command line.
<div style="border: 1px solid black; padding: 2px; display: inline-block;">ESC</div>	This function works in a different manner according to the presence or absence of input character(s). Presence of input character(s): All input character(s) on the command line are cleared. Absence of input character(s): The system returns to the detailed positional data directory display.

Press the EXE key, and the position name is replaced by the newly specified name. The following display appears.

P O I N T	5 5 5 5 5	[5 /	1 0]
X :	3 0 0 . 0 0 0	C O N F I G : F R E E		
Y :	3 0 0 . 0 0 0			
Z :	3 0 0 . 0 0 0			
C :	3 0 0 . 0 0 0			
T :	3 0 0 . 0 0 0			
3 0 0 . 0 0 0		w / . w o r l d		
S A V E	P R G	D I R	T R A N S	P Y L D >

- The main cursor moves to the X data area.
- If the input name is illegal, a message saying "ILLEGAL NAME" is displayed on the command line and no data is changed.
- If the specified name already exists, a message of "DUPLICATE NAME" is displayed on the command line and no data is changed.

5.3.2 Editing of Detailed Positional Data Element

(1) Function

Used to edit a position element.

(2) Procedures

When you press the EXE key while the main cursor is located at each position element, you can edit that data.

In the example below, assume that you are going to change the X data from "300.000" to "100".

(a) Step 1: Data selection.

Move the main cursor to the data you wish to edit by means of the cursor keys (↑, ↓), and the following display appears.

P O I N T 0 0 0 0 5	[5 / 1 0]
X : 3 0 0 . 0 0 0	C O N F I G : F R E E
Y : 3 0 0 . 0 0 0	
Z : 3 0 0 . 0 0 0	
C : 3 0 0 . 0 0 0	
T : 3 0 0 . 0 0 0	
3 0 0 . 0 0 0	w / . w o r l d
SAVE	PRG DIR TRANS PYLD >

Press the EXE key, and the following display is called. (The cursor is displayed on the command line.)

P O I N T 0 0 0 0 5	[5 / 1 0]
X : 3 0 0 . 0 0 0	C O N F I G : F R E E
Y : 3 0 0 . 0 0 0	
Z : 3 0 0 . 0 0 0	
C : 3 0 0 . 0 0 0	
T : 3 0 0 . 0 0 0	
3 0 0 . 0 0 0 _	w / . w o r l d
SAVE	PRG DIR TRANS PYLD >

- Current data is displayed as the initial value on the command line.
- The cursor on the command line is displayed next to the initially displayed name, and you can edit the data.
- When the cursor is shown by the mark "■", the replace mode takes effect. When the cursor is shown by the mark "_", the insert mode is effective.

Keys operative in this mode and their operations are shown below.

Key	Descriptions
	Used to move the cursor left on the command line.
	Used to move the cursor right on the command line.
<div style="border: 1px solid black; padding: 2px; display: inline-block;">Numeral</div> 	Used to input characters on the command line.
<div style="border: 1px solid black; padding: 2px; display: inline-block;">EXE</div>	Used to change current position element to an entered one. The system returns to the detailed position directory display mode with the main cursor moved to the next data area.
<div style="border: 1px solid black; padding: 2px; display: inline-block;">INS</div>	Used to select the insert or replace mode for the command line.
<div style="border: 1px solid black; padding: 2px; display: inline-block;">BS</div>	Used to delete one (1) character just before the cursor position on the command line.
<div style="border: 1px solid black; padding: 2px; display: inline-block;">ALT+BS</div>	Used to delete one (1) character at the cursor position on the command line.
<div style="border: 1px solid black; padding: 2px; display: inline-block;">ESC</div>	<p>This function works in a different manner according to the presence or absence of input character(s).</p> <p>Presence of input character(s): All input character(s) on the command line are cleared.</p> <p>Absence of input character(s): The system returns to the detailed positional data directory display.</p>

(b) Step 2: Data editing.

Enter a value you want to change into the command line using alphanumeric keys, → key, or ← key.

```

P O I N T 0 0 0 0 5 [ 5 / 1 0 ]
X : 3 0 0 . 0 0 0 C O N F I G : F R E E
Y : 3 0 0 . 0 0 0
Z : 3 0 0 . 0 0 0
C : 3 0 0 . 0 0 0
T : 3 0 0 . 0 0 0
1 0 0 _ w / . w o r l d
SAVE PRG DIR TRANS PYLD >
    
```

Press the EXE key, and the data is changed to the newly entered data. The system returns to the detailed positional data display mode, and main cursor moves to the next data area. The following display appears.

P O I N T 0 0 0 0 5	[5 / 1 0]
X : 1 0 0 . 0 0 0	C O N F I G : F R E E
Y : 3 0 0 . 0 0 0	
Z : 3 0 0 . 0 0 0	
C : 3 0 0 . 0 0 0	
T : 3 0 0 . 0 0 0	
3 0 0 . 0 0 0	w / . w o r l d
SAVE	PRG DIR TRANS PYLD >

(3) Caution

When the CONFIG data is edited, only the first character of the data can be edited.

The relationship between the input character and the set value is shown below.

Input character	Set value
F or 0	FREE
R or 1	RIGHTY
L or 2	LEFTY

5.3.3 Call of Positional Data Directory Display [DIR]

(1) Function

Displays the positional data directory display.

(2) Procedures

(a) Step 1: Command selection.

Select the data display mode as shown below (i.e., the cursor is not present on the command line).

P O I N T 0 0 0 0 5	[5 / 1 0]
X : 3 0 0 . 0 0 0	C O N F I G : F R E E
Y : 3 0 0 . 0 0 0	
Z : 3 0 0 . 0 0 0	
C : 3 0 0 . 0 0 0	
T : 3 0 0 . 0 0 0	
P O I N T 0 0 0 0 5	w / . w o r l d
SAVE PRG DIR TRANS PYLD >	

Press [DIR] and the following directory display is called.

	P O I N T	X	Y	Z
↑	P O I N T 0 0 0 0 3 =	1 0 0 ,	1 0 0 ,	1 0 0 ,
	P O I N T 0 0 0 0 4 =	2 0 0 ,	2 0 0 ,	2 0 0 ,
	P O I N T 0 0 0 0 5 =	3 0 0 ,	3 0 0 ,	3 0 0 ,
	P O I N T 0 0 0 0 6 =	4 0 0 ,	4 0 0 ,	4 0 0 ,
↓	P O I N T 0 0 0 0 7 =	5 0 0 ,	5 0 0 ,	5 0 0 ,
	P O I N T 0 0 0 0 5	w / . w o r l d		
	SAVE PRG FULL TRANS PYLD >			

For details of operations to be done on the detailed display, see Para. 5.2.

5.4 Coordinate Data Directory Display Mode

The coordinate data directory display mode displays one (1) coordinate on one (1) line at a time. In this mode, it is possible to add and delete the coordinate data. An example of display is given below.







TRANS SELECTION		[3 /	1 1]
	. w o r l d			1 0
w	T R A N S 0 0 0 0 1			0
	T R A N S 0 0 0 0 2			5
t	T R A N S 0 0 0 0 3			0
↓	T R A N S 0 0 0 0 4			4
	T R A N S 0 0 0 0 2			
	S A V E	P R G	P Y L D	W O R K
				T O O L
				>

Each time the NEXT key is pressed, the menu is changed over as follows:

<	N O S A V	F I N D	C U T	P A S T E																
---	-----------	---------	-------	-----------	--	--	--	--	--	--	--	--	--	--	--	--	--	--	--	--

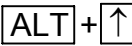
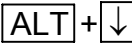
- An inversely displayed section in the data is called the "main cursor" which indicates that this data is selected for editing.
- Symbol "↑" shown in the 1st column signifies that there is coordinate data before the top data.
- Symbol "↓" shown in the 1st column signifies that there is coordinate data after the final data.
- Alphabet "t" displayed in the 1st column represents that the coordinate data on the same line is based on the tool coordinate system.
- Alphabet "w" displayed in the 1st column represents that the coordinate data on the same line is based on the work coordinate system.
- On the right side of the coordinate name, the number of positional data belonging to that coordinate is displayed.
- Regarding the data of [nnnn/mmmm] on the 1st line, "nnnn" identifies the selected coordinate index, and "mmm" the number of coordinate data.

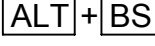
Keys operative in this mode and their operations are shown below.

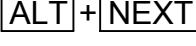
Key	Descriptions
	Used to move the main cursor up. If the main cursor is located on the top line of screen, the screen scrolls down.
	Used to move the main cursor down. If the main cursor is located on the last line of screen, the screen scrolls up.
	Used to move the main cursor up on the screen basis.
	Used to move the main cursor down on the screen basis.
	Used to create a new coordinate data.
	Used to delete a coordinate data indicated by the main cursor. All positional data contained this coordinate are also deleted.
	The system proceeds to the detailed coordinate display where you can edit a coordinate data indicated by the main cursor.
	Used to toggle the menu (resulting in the next menu).
	Used to toggle the menu (resulting in the previous menu).

Operations of each menu are shown below.

Menu	Descriptions
[SAVE]	Used to save a data and quit the data editor.
[PRG]	Used to select the program editor display. If the data editor was started up, however, the display will not change over.
[PYLD]	Used to select the load data editor display.
[WORK]	Used to select the positional data directory display where you can edit a positional data belonging to a coordinate system indicated by the main cursor.
[TOOL]	Used to specify the tool coordinate system for a coordinate system indicated by the cursor, and cancel the designation.
[NOSAV]	Used to quit the editor without saving data. All changed data are aborted.
[FIND]	Used to search a coordinate name.
[CUT]	Used to select the range select mode.
[PASTE]	Used to paste the contents saved in the cut buffer (i.e., data deleted by the previous cut menu) after a positional data indicated by the main cursor to clear the cut buffer.

Each menu of [SAVE], [NOSAV] and [PRG] is the same as in the positional data directory display mode and is not described in this paragraph.

5.4.1 Addition of New Coordinate Data (INS)

- (1) Function
Adds a new coordinate data.
- (2) Procedures
Assume that you are going to add a new coordinate data ("TRANS00020") just after "TRANS00002."

(a) Step 1: Selection of position to add new coordinate data
Move the main cursor to "TRANS00002" using the ↑ key or ↓ key, and the following display is called.

T R A N S		S E L E C T I O N	[3 /	1 1]
	. w o r l d			1 0	
w	T R A N S 0 0 0 0 1			0	
	T R A N S 0 0 0 0 2			5	
t	T R A N S 0 0 0 0 3			0	
↓	T R A N S 0 0 0 0 4			4	
T R A N S 0 0 0 0 2					
	S A V E	P R G	P Y L D	W O R K	T O O L >

- (b) Step 2: Name input.
Press the INS key, and the display changes as shown below with the name input mode selected. (The cursor is displayed on the command line.)

T R A N S		S E L E C T I O N	[4 /	1 2]
	. w o r l d			1 0	
w	T R A N S 0 0 0 0 1			0	
	T R A N S 0 0 0 0 2			5	
	_____			0	
t	T R A N S 0 0 0 0 3			0	
- T R A N S 0 0 0 0 2					
	S A V E	P R G	P Y L D	W O R K	T O O L >

Enter "TRANS00020" and press the EXE key. The display changes as follows:

T R A N S S E L E C T I O N										[4	/	1	2]										
	.	w	r	l	d										1	0									
w	T	R	A	N	S	0	0	0	0	1						0									
	T	R	A	N	S	0	0	0	0	2						5									
	T	R	A	N	S	0	0	0	2	0						0									
t	T	R	A	N	S	0	0	0	0	3						0									
T R A N S 0 0 0 2 0																									
	S	A	V	E		P	R	G		P	Y	L	D		W	O	R	K		T	O	O	L		>

(3) Cautions

- For the newly added coordinate data, zero (0) is set for all elements.
- A data is added to just below the main cursor.
- When you have pressed the ESC key without specifying the name, addition of the new data is canceled and the system returns.

5.4.2 Deletion of Coordinate Data (ALT + BS)

(1) Function

Deletes a coordinate data.

(2) Procedures

Assume that you are going to delete the data of "TRANS00002".

(a) Step 1: Data selection.

Move the main cursor to "TRANS00002", and the following display is called.

T R A N S S E L E C T I O N										[3 /	1 1]													
	.	w	o	r	l	d					1	0													
w	T	R	A	N	S	0	0	0	0	1		0													
	T	R	A	N	S	0	0	0	0	2		5													
t	T	R	A	N	S	0	0	0	0	3		0													
↓	T	R	A	N	S	0	0	0	0	4		4													
T R A N S 0 0 0 0 2																									
	S	A	V	E		P	R	G		P	Y	L	D		W	O	R	K		T	O	O	L		>

(b) Step 2: Delete.

Press the ALT and BS keys at the same time, and the following display appears with the specified data deleted.

T R A N S S E L E C T I O N										[3 /	1 0]													
	.	w	o	r	l	d					1	0													
w	T	R	A	N	S	0	0	0	0	1		0													
t	T	R	A	N	S	0	0	0	0	3		0													
	T	R	A	N	S	0	0	0	0	4		4													
↓	T	R	A	N	S	0	0	0	0	5		5													
T R A N S 0 0 0 0 3																									
	S	A	V	E		P	R	G		P	Y	L	D		W	O	R	K		T	O	O	L		>

(3) Cautions

- When a coordinate data is deleted, all positional data belong to that coordinate system are also deleted.
- Different from the [CUT] function, you cannot undo a data deleted by this operation.
- A world coordinate cannot be deleted.
- A coordinate selected as the tool or work coordinate cannot be deleted.

5.4.3 Call of Detailed Coordinate Data Display

(1) Function

Displays the detailed coordinate data display.

The elements of coordinate data can be changed in the detailed display only.

(2) Procedures

Assume that you are going to display the data of "TRANS00002" in detail.

(a) Step 1: Data selection.

Move the main cursor to "TRANS00002", and the following display appears.

T R A N S S E L E C T I O N										[3	/	1	1]	
	.	w	o	r	l	d									1	0
w		T	R	A	N	S	0	0	0	0	1					0
		T	R	A	N	S	0	0	0	0	2					5
t		T	R	A	N	S	0	0	0	0	3					0
↓		T	R	A	N	S	0	0	0	0	4					4
T R A N S 0 0 0 0 2																
S A V E			P R G			P Y L D			W O R K			T O O L			>	

Press the EXE key and the following detailed display is called.

T R A N S 0 0 0 0 2										[3	/	1	1]
X :		5	0	0	.	0	0	0							
Y :		0	.	0	0	0									
Z :		0	.	0	0	0									
C :		0	.	0	0	0									
T R A N S 0 0 0 0 2															
S A V E			T E A C H			D I R			W O R K			F I N D			>

(3) Cautions

- A world coordinate cannot be edited.
- A coordinate selected as the tool coordinate or work coordinate cannot be edited.

For details of operations to be done on the detailed display, see Para. 5.5.

5.4.4 Call of Load Data Directory Display [PYLD]

(1) Function

Calls the load data directory display.

(2) Procedures

(a) Step 1: Command selection.

Select the data display mode as shown below (i.e., the cursor is not present on the command line).

T R A N S S E L E C T I O N										[3	/	1	1]										
	.	w	o	r	l	d									1	0									
w	T	R	A	N	S	0	0	0	0	1						0									
	T	R	A	N	S	0	0	0	0	2						5									
t	T	R	A	N	S	0	0	0	0	3						0									
↓	T	R	A	N	S	0	0	0	0	4						4									
T R A N S 0 0 0 0 2																									
	S	A	V	E		P	R	G		P	Y	L	D		W	O	R	K		T	O	O	L		>

Press [PYLD], and the following load data directory display appears.

L O A D										W E I G H T										O F F S E T									
	L	O	A	D	0	0	0	0	0	1	=	1	0	0	.	0	0	0	,	1	0	0	.	0	0	0			
	L	O	A	D	0	0	0	0	0	2	=	1	0	.	0	0	0	,	0	.	0	0	0						
	L	O	A	D	0	0	0	0	0	3	=	1	0	.	0	0	0	,	0	.	0	0	0						
	L	O	A	D	0	0	0	0	0	4	=	2	0	.	0	0	0	,	0	.	0	0	0						
↓	L	O	A	D	0	0	0	0	0	5	=	5	0	.	0	0	0	,	0	.	0	0	0						
L O A D 0 0 0 0 0 3																													
	S	A	V	E		P	R	G		P	O	I	N	T		T	R	A	N	S		F	I	N	D		>		

(3) Caution

On the load data directory display, the main cursor indicates the position of the data displayed before. At initial display, the data are displayed from the beginning.

For details of operations to be done on the load data display, see Para. 5.6.

5.4.5 Setting of Work Coordinate System (Call of Positional Data Directory Display) [WORK]

(1) Function

Sets a specified coordinate in the work coordinate system and calls the directory display of a positional data belonging to that coordinate system.

(2) Procedures

Assume that you are going to set "TRANS00002" in the work coordinate system and call the relevant positional data directory display.

(a) Step 1: Command selection.

Move the main cursor to "TRANS00002", and the following display appears.

T R A N S S E L E C T I O N										[3 /	1 1]
	.	w										1 0
			T	R	A	N	S	0	0	0	0	1
			T	R	A	N	S	0	0	0	0	2
			T	R	A	N	S	0	0	0	0	3
			T	R	A	N	S	0	0	0	0	4
			T	R	A	N	S	0	0	0	0	2
			S	A	V	E	P	R	G	P	Y	L
			W	O	R	K	T	O	O	L	>	

Press [WORK], and the data of "TRANS00002" is set in the work coordinate system with the positional data directory display belonging to the "TRANS00002" coordinate system called, as shown below.

P O I N T										X	Y	Z
	P	1	=	1	0	0	,	0	,	0	,	
	P	2	=	2	0	0	,	0	,	0	,	
	P	3	=	3	0	0	,	0	,	0	,	
	P	4	=	4	0	0	,	0	,	0	,	
	P	5	=	5	0	0	,	0	,	0	,	
	P	1								w / .	T	R
											A	N
											S	P
											Y	L
											D	>

(3) Cautions

- If this operation is done for the world coordinate system, setting of the work coordinate system is canceled.
- A coordinate set as the work coordinate is identified by "w" in the 1st column on the coordinate data directory display.

5.4.6 Setting and Canceling of the Tool Coordinate System [TOOL]

(1) Function

Sets a specified coordinate in the tool coordinate system. If this operation is done for a coordinate already set as the tool coordinate, setting of the tool coordinate system is canceled.

(2) Procedures

Assume that you are going to set "TRANS00002" in the tool coordinate system.

(a) Step 1: Command selection.

Move the main cursor to "TRANS00002", and the following display appears.

T R A N S S E L E C T I O N										[3 /	1 1]													
	.	w	o	r	l	d					1	0													
w	T	R	A	N	S	0	0	0	0	1		0													
	T	R	A	N	S	0	0	0	0	2		5													
t	T	R	A	N	S	0	0	0	0	3		0													
↓	T	R	A	N	S	0	0	0	0	4		4													
T R A N S 0 0 0 0 2																									
	S	A	V	E		P	R	G		P	Y	L	D		W	O	R	K		T	O	O	L		>

Press [TOOL], and the data of "TRANS00002" is set in the tool coordinate system and the following display appears.

T R A N S S E L E C T I O N										[3 /	1 1]													
	.	w	o	r	l	d					1	0													
w	T	R	A	N	S	0	0	0	0	1		0													
t	T	R	A	N	S	0	0	0	0	2		5													
	T	R	A	N	S	0	0	0	0	3		0													
↓	T	R	A	N	S	0	0	0	0	4		4													
T R A N S 0 0 0 0 2																									
	S	A	V	E		P	R	G		P	Y	L	D		W	O	R	K		T	O	O	L		>

(3) Cautions

- If another coordinate was already set as the tool coordinate, it is canceled by this function.
- A coordinate set as the tool coordinate is identified by "t" in the 1st column of the display.

5.4.7 Search of Coordinate Data [FIND]

(1) Function

Searches the data bearing the specified coordinate name.

(2) Procedures

Assume that you are going to search the coordinate data named "TRANS00008."

(a) Step 1: Command selection.

Press the NEXT key repeatedly until [FIND] is displayed in the command menu.

T R A N S		S E L E C T I O N		[3 /	1 1]
	. w o r l d				1 0	
w	T R A N S 0 0 0 0 1				0	
	T R A N S 0 0 0 0 2				5	
t	T R A N S 0 0 0 0 3				0	
↓	T R A N S 0 0 0 0 4				4	
T R A N S 0 0 0 0 2						
<	N O S A V	F I N D	C U T	P A S T E		

Press [FIND], and the following display appears.









T R A N S		S E L E C T I O N		[3 /	1 1]
	. w o r l d				1 0	
w	T R A N S 0 0 0 0 1				0	
	T R A N S 0 0 0 0 2				5	
t	T R A N S 0 0 0 0 3				0	
↓	T R A N S 0 0 0 0 4				4	
F I N D : _						

(b) Step 2: Data name input.

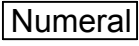
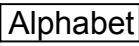
Enter "TRANS00008", and the display is changed over as shown below.

T R A N S		S E L E C T I O N		[3 /	1 1]
	. w o r l d				1 0	
w	T R A N S 0 0 0 0 1				0	
	T R A N S 0 0 0 0 2				5	
t	T R A N S 0 0 0 0 3				0	
↓	T R A N S 0 0 0 0 4				4	
F I N D : T R A N S 0 0 0 0 8 _						

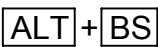
Keys operative in this mode and their operations are shown below.

Key	Descriptions
	Used to move the cursor left on the command line.
	Used to move the cursor right on the command line.
 	Used to input characters on the command line.
	Used to search the specified coordinate name and return the system to the coordinate data directory display. Unless the specified data is present, a message saying "Not found" is displayed on the command line.
	Used to select the insert or replace mode for the command line.
	Used to delete one (1) character just before the cursor position on the command line.
	Used to delete one (1) character at the cursor position on the command line.
	This function works in a different manner according to the presence or absence of input character(s). Presence of input character(s): All input character(s) on the command line are cleared. Absence of input character(s): The system returns to the coordinate data directory display.

(c) Step 3: Search.

Press the EXE key, and search for the specified coordinate name starts. If found, the coordinate data directory is displayed with the specified data at the head of the screen and the main cursor moved there. The display is as shown below.

T R A N S	S E L E C T I O N	[9 /	1 1]
T R A N S 0 0 0 0 8			1 0	
T R A N S 0 0 0 0 9			1 0	
T R A N S 0 0 0 1 0			6	
T R A N S 0 0 0 0 8				
< N O S A V	F I N D	C U T	P A S T E	

(3) Cautions

- Unless the specified name exists, the system returns to the previous directory display with a message of "NOT FOUND" shown on the command line.
- As the search is performed throughout the file, the search start position is unrelated to the search operation.

5.4.8 Cut of Coordinate Data [CUT]

(1) Function

Cuts multiple coordinate data simultaneously.

(2) Procedures

Assume that you are going to cut the positional data of "TRANS00001" ~ "TRANS00003".

(a) Step 1: Command selection.

Move the main cursor to "TRANS00001" and press the NEXT key repeatedly until [CUT] is displayed in the command menu.

T R A N S S E L E C T I O N										[2 /	1 1]	
. w o r l d											1 0		
T R A N S 0 0 0 0 1											0		
T R A N S 0 0 0 0 2											5		
T R A N S 0 0 0 0 3											0		
↓	T R A N S 0 0 0 0 4											4	
T R A N S 0 0 0 0 1													
<	N O S A V			F I N D			C U T			P A S T E			

Press [CUT], and the entire data at the main cursor position is displayed by reversed image to indicate that it is selected. The display is as shown below.

T R A N S S E L E C T I O N										[2 /	1 1]	
. w o r l d											1 0		
T R A N S 0 0 0 0 1											0		
T R A N S 0 0 0 0 2											5		
T R A N S 0 0 0 0 3											0		
↓	T R A N S 0 0 0 0 4											4	
T R A N S 0 0 0 0 1													
											C U T		

(b) Step 2: Range selection.

Move the main cursor by means of the ↓ key or ↑ key to change the selection range. The following display then appears.

T R A N S S E L E C T I O N										[4	/	1	1]	
. w o r l d											1	0				
T R A N S 0 0 0 0 1															0	
T R A N S 0 0 0 0 2															5	
T R A N S 0 0 0 0 3															0	
↓	T R A N S 0 0 0 0 4															4
T R A N S 0 0 0 0 3										C U T						

- The entire data selected is displayed inversely.
- Either world coordinate, tool coordinate or work coordinate is not included in the selection range.
- The main cursor indicates the data next to the selection range.

Keys operative in this mode and their operations are shown below.

Key	Descriptions
↑	Used to widen the selection range upward.
↓	Used to widen the selection range downward.
[ALT] + ↑	Used to widen the selection range upward on the screen basis.
[ALT] + ↓	Used to widen the selection range downward on the screen basis.
[ESC]	Cancels the range selection and returns the system to the coordinate data directory display mode.

Operation of each menu is shown below.

Menu	Descriptions
[CUT]	Used to save the data in the selection range in the cut buffer and delete that data.

(c) Step 3: Cut.

Press [CUT] to cut the selected data at once. The display changes over as shown below.

T R A N S S E L E C T I O N										[2 /	8]	
. w o r l d											1 0		
T R A N S 0 0 0 0 4											4		
T R A N S 0 0 0 0 5											5		
T R A N S 0 0 0 0 6											0		
↓	T R A N S 0 0 0 0 7											0	
T R A N S 0 0 0 0 4													
<	N O S A V		F I N D		C U T		P A S T E						

(3) Cautions

- All positional data belonging to relevant coordinate system are also deleted.
- A world coordinate cannot be selected or deleted.
- Data set in the tool coordinate system cannot be selected or deleted.
- Data set in the work coordinate system cannot be selected or deleted.
- When this cut function is used, cut data can be saved in the cut buffer and pasted at another position by means of the paste function stated in the next paragraph.

5.4.9 Paste of Coordinate Data [PASTE]

(1) Function

Pastes multiple coordinate data cut by the cut function at another position.

(2) Procedures

Assume that you are going to paste the cut data (TRANS00001 ~ TRANS00003) after "TRANS00005."

(a) Step 1: Command selection.

Move the main cursor to "TRANS00005" and press the NEXT key repeatedly until [PASTE] is displayed in the soft key menu.

T R A N S S E L E C T I O N										[3 /	8]	
. w o r l d											1 0		
T R A N S 0 0 0 0 4											4		
T R A N S 0 0 0 0 5											5		
T R A N S 0 0 0 0 6											0		
↓	T R A N S 0 0 0 0 7											0	
T R A N S 0 0 0 0 5													
<	N O S A V		F I N D		C U T		P A S T E						

Press [PASTE], and the cut data is pasted. The display is as shown below.

T R A N S S E L E C T I O N										[3 /	1 1]	
. w o r l d											1 0		
T R A N S 0 0 0 0 4											4		
T R A N S 0 0 0 0 5											5		
T R A N S 0 0 0 0 1											0		
↓	T R A N S 0 0 0 0 2											5	
T R A N S 0 0 0 0 5													
<	N O S A V		F I N D		C U T		P A S T E						

(3) Cautions

- Cut data can be pasted under the main cursor.
- Positional data belonging to each coordinate data is also pasted.

5.5 Detailed Coordinate Data Display Mode

The detailed coordinate data display mode displays one (1) coordinate data on the full screen. In this mode, it is possible to edit the coordinate data name and element.

An example of display is given below.

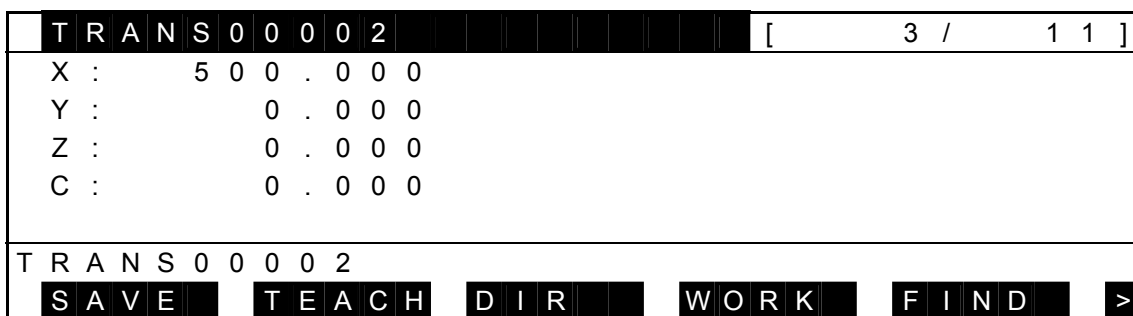







Each time the NEXT key is pressed, the menu is changed over as follows:



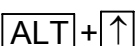
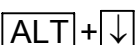

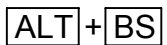

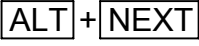

- An inversely displayed section in the data is called the "main cursor" which indicates that this data is selected for editing.
- For the data of [nnnn/mmmm] displayed on the 1st line, "nnnn" signifies the number of positional data contained in the selected coordinate system. "mmm" represents the total number of positional data in all coordinate systems.

Keys operative in this mode and their operations are shown below.

Key	Descriptions
	Used to move the main cursor to each data in the order of [Name ← X ← Y ← Z ← C ← T ← Name].
	Used to move the main cursor to each data in the order of [Name → X → Y → Z → C → T → Name].
	Used to display the defined detailed coordinate data before current coordinate data.
	Used to display the defined detailed coordinate data after current coordinate data.
	Used to create a new coordinate data.
	Used to delete a current coordinate data and display in detail the coordinate data defined next.
	Used to edit a data indicated by the main cursor.
	Used to toggle the menu (resulting in the next menu).
	Used to toggle the menu (resulting in the previous menu).

Operations of each menu are shown below.

Menu	Descriptions
	Used to save a data and quit the data editor.
	Used to teach a current position of the robot in a coordinate data indicated by the main cursor.
	Used to select the coordinate data directory display.
	Used to select the positional data directory display where you can edit a positional data belonging to a coordinate system indicated by the main cursor.
	Used to select the coordinate name search mode.
	Used to quit the editor without saving data. All changed data are aborted.

Each menu of [SAVE] and [NOSAV] is the same as in the positional data directory display mode and is not described in this paragraph.

5.5.1 Editing of Coordinate Data Name

(1) Function

Edits a coordinate data name.

(2) Procedures

When you press the EXE key while the main cursor is located at the coordinate name, you can edit the coordinate name.

In the example below, assume that you are going to change the name of "TRANS00002" to "TRANS00022."

(a) Step 1: Data selection.

Move the main cursor to "TRANS00002" by means of the cursor keys (↑, ↓) and the following display appears.

T	R	A	N	S	0	0	0	0	2	[3	/	1	1]
X :	5	0	0	.	0	0	0								
Y :	0	.	0	0	0										
Z :	0	.	0	0	0										
C :	0	.	0	0	0										
T R A N S 0 0 0 0 2															
SAVE			TEACH			DIR			WORK			FIND			>

Press the EXE key, and the following display is called. (The cursor is displayed on the command line.)

T	R	A	N	S	0	0	0	0	2	[3	/	1	1]
X :	5	0	0	.	0	0	0								
Y :	0	.	0	0	0										
Z :	0	.	0	0	0										
C :	0	.	0	0	0										
T R A N S 0 0 0 0 2 _															
SAVE			TEACH			DIR			WORK			FIND			>

- Current data is displayed as the initial value on the command line.
- The cursor on the command line is displayed next to the initially displayed name, and you can edit the data.
- When the cursor is shown by the mark "■", the replace mode takes effect. When the cursor is shown by the mark "_", the insert mode is effective.

(b) Step 2: Data name input.

Enter a desired name to the command line, using alphanumeric keys, → key, and ← key. Then the following display appears.

T	R	A	N	S	0	0	0	0	2											[3	/	1	1]				
X :		5	0	0	.	0	0	0																					
Y :		0	.	0	0	0																							
Z :		0	.	0	0	0																							
C :		0	.	0	0	0																							
T R A N S 0 0 0 2 2 _																													
SAVE					TEACH					DIR					WORK					FIND					>				

Keys operative in this mode and their operations are shown below.

Key	Descriptions
	Used to move the cursor left on the command line.
	Used to move the cursor right on the command line.
<div style="border: 1px solid black; padding: 2px; display: inline-block;">Numeral</div> <div style="border: 1px solid black; padding: 2px; display: inline-block;">Alphabet</div>	Used to input characters on the command line.
<div style="border: 1px solid black; padding: 2px; display: inline-block;">EXE</div>	Used to change current coordinate name to an entered one. The system returns to the detailed coordinate data display mode with the cursor moved to the X-data area.
<div style="border: 1px solid black; padding: 2px; display: inline-block;">INS</div>	Used to select the insert or replace mode for the command line.
<div style="border: 1px solid black; padding: 2px; display: inline-block;">BS</div>	Used to delete one (1) character just before the cursor position on the command line.
<div style="border: 1px solid black; padding: 2px; display: inline-block;">ALT</div> + <div style="border: 1px solid black; padding: 2px; display: inline-block;">BS</div>	Used to delete one (1) character at the cursor position on the command line.
<div style="border: 1px solid black; padding: 2px; display: inline-block;">ESC</div>	<p>This function works in a different manner according to the presence or absence of input character(s).</p> <p>Presence of input character(s): All input character(s) on the command line are cleared.</p> <p>Absence of input character(s): The system returns to the detailed coordinate data directory display.</p>

Press the EXE key, and the coordinate name is replaced by the newly specified name. The following display appears.

T R A N S 0 0 0 2 2										[3 / 1 1]		
X :	5	0	0	.	0	0	0					
Y :		0	.	0	0	0						
Z :		0	.	0	0	0						
C :		0	.	0	0	0						
5 0 0 . 0 0 0												
S A V E		T E A C H			D I R		W O R K			F I N D		>

The main cursor moves to the X data area. If the input name is illegal, a message saying "ILLEGAL NAME" is displayed on the command line and no data is changed. If the specified name already exists, a message of "DUPLICATE NAME" is displayed on the command line and no data is changed.

5.5.2 Editing of Coordinate Element

(1) Function

Used to edit a coordinate element.

(2) Procedures

When you press the EXE key while the main cursor is located at each coordinate element, you can edit that data.

In the example below, assume that you are going to change the X data from "500.000" to "100".

(a) Step 1: Data selection.

Move the main cursor to the data you wish to edit by means of the cursor keys (↑, ↓), and the following display appears.

T R A N S 0 0 0 0 2	[3 / 1 1]
X : ■ ■ ■ 5 0 0 . 0 0 0	
Y : 0 . 0 0 0	
Z : 0 . 0 0 0	
C : 0 . 0 0 0	
5 0 0 . 0 0 0	
SAVE	TEACH DIR WORK FIND >

Press the EXE key, and the following display is called. (The cursor is displayed on the command line.)

T R A N S 0 0 0 0 2	[3 / 1 1]
X : ■ ■ ■ 5 0 0 . 0 0 0	
Y : 0 . 0 0 0	
Z : 0 . 0 0 0	
C : 0 . 0 0 0	
5 0 0 . 0 0 0 _	
SAVE	TEACH DIR WORK FIND >

- Current data is displayed as the initial value on the command line.
- The cursor on the command line is displayed next to the initially displayed data, and you can edit the data.
- When the cursor is shown by the mark "■", the replace mode takes effect. When the cursor is shown by the mark "_", the insert mode is effective.

(b) Step 2: Data input.

Enter a desired value to the command line, using alphanumeric keys, → key, and ← key. Then the following display appears.

T R A N S 0 0 0 0 2										[3 / 1 1]		
X :	5	0	0	.	0	0	0					
Y :		0	.	0	0	0						
Z :		0	.	0	0	0						
C :		0	.	0	0	0						
1 0 0 _												
SAVE		TEACH			DIR		WORK			FIND		>

Keys operative in this mode and their operations are shown below.

Key	Descriptions
	Used to move the cursor left on the command line.
	Used to move the cursor right on the command line.
[Numeral] [.] [+] [-]	Used to input characters on the command line.
[EXE]	Used to change current coordinate element to an entered one. The system returns to the display mode with the main cursor moved to the next data area.
[INS]	Used to select the insert or replace mode for the command line.
[BS]	Used to delete one (1) character just before the cursor position on the command line.
[ALT]+[BS]	Used to delete one (1) character at the cursor position on the command line.
[ESC]	This function works in a different manner according to the presence or absence of input character(s). Presence of input character(s): All input character(s) on the command line are cleared. Absence of input character(s): The system returns to the detailed coordinate data directory display.

Press the EXE key, and the coordinate element is replaced by the newly specified data. The system returns to the detailed coordinate data directory display mode with the main cursor moved to the next data area. The display is as shown below.

T R A N S 0 0 0 0 2										[3 /		1 1]	
X :	1 0 0		.	0 0 0											
Y :	0		.	0 0 0											
Z :	0		.	0 0 0											
C :	0		.	0 0 0											
0 . 0 0 0															
SAVE		TEACH		DIR		WORK		FIND		>					

5.5.3 Teaching of Coordinate Data [TEACH]

(1) Function

Guides the robot tool tip to the teach point, then registers the current position coordinate data of the robot in the coordinate data indicated by the main cursor.

(2) Procedures

Assume that you are going to teach the current position coordinate data of the robot in the coordinate data of "TRANS00002."

(a) Step 1: Command selection

Call the detailed coordinate data display of "TRANS00002."



Press [TEACH], and the display as shown below appears.

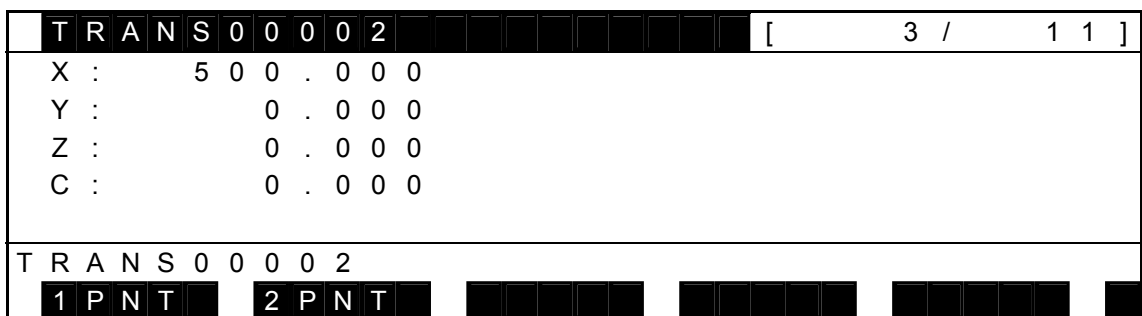

Teaching of coordinate data comes in the following two (2) types.

1. 1-point teaching mode in which the origin and direction are taught at the same time.
2. 3-point teaching mode in which the origin and direction are taught separately in three (3) steps.

Select a desired teaching mode now.

The key operative in this mode and its operation are shown below.

Key	Descriptions
[ESC]	Used to cancel the detailed coordinate teaching mode and return the system to the detailed display.

Operations of each menu are shown below.

Menu	Descriptions
[1PNT]	Used to select the 1-point teaching mode.
[2PNT]	Used to select the 2-point teaching mode.

A. 1-point teaching mode

(b) Step 2: Selection of 1-point teaching mode

Press **[1PNT]**, and the following display appears.

T R A N S 0 0 0 0 2										[3 / 1 1]									
X :	5	0	0	.	0	0	0												
Y :		0	.	0	0	0													
Z :		0	.	0	0	0													
C :		0	.	0	0	0													
1 p — t e a c h / C o o r d i n a t e :																			

(c) Step 3: Coordinate data register.

Guide the robot tool tip to the teach point and set the direction of the tool coordinate to the direction of the coordinate you wish to teach.

Keys operative in this mode and their operations are shown below.

Key	Descriptions
[EXE]	Used to register the current position of the robot as the coordinate data.
[ESC]	Used to cancel the 1-point teaching mode and return the system to the teaching mode select display.



CAUTION

In principle, the teaching operation should be performed outside the dangerous area of the robot. If it should be performed inevitably within the dangerous area, strictly observe the following matters.

- (1) The teaching operation should always be performed by two (2) persons. One person performs the job and the other person watches outside the dangerous area. Also, both persons should try to prevent mis-operation with each other.
- (2) The operator should do the job in an attitude ready to press the EMERGENCY stop pushbutton switch at any time. Also, he should perform the job at a position from which he can evacuate immediately at the time of emergency after confirming the robot working range and shields nearby.
- (3) The supervisor should keep watch on the job at a position where he can see the entire robot system and operate the EMERGENCY stop pushbutton switch at the time of an emergency. Also, he should keep anyone from entering the dangerous area.

Press the EXE key, and the current position of the robot is registered as the coordinate data.

For instance, when the current position of the robot is,

```
X   100.000
Y   100.000
Z   100.000
```

the display is as shown below.

T R A N S 0 0 0 0 2										[3 / 1 1]											
X :	1	0	0	.	0	0	0														
Y :	1	0	0	.	0	0	0														
Z :	1	0	0	.	0	0	0														
C :	0	.	0	0	0	0															
T R A N S 0 0 0 0 2																					
S A V E			T E A C H			D I R			W O R K			F I N D			>						

B. 3-point teaching mode

(b) Step 2: Selection of 3-point teaching mode.

Press [3PNT], and the following display appears, where you can teach the origin.

T	R	A	N	S	0	0	0	0	2	[3	/	1	1]
X :	5	0	0	.	0	0	0								
Y :	0	.	0	0	0	0									
Z :	0	.	0	0	0	0									
C :	0	.	0	0	0	0									
2 p — t e a c h / o r i g i n :															

(c) Step 3: Coordinate data register.

Guide the robot tool tip to the origin of the coordinate system you wish to teach.

Keys operative in this mode and their operations are shown below.

Key	Descriptions
[EXE]	Used to register the current position of the robot as the origin of a new coordinate system.
[↓]	Used to select the current coordinate data for the origin.
[ESC]	Used to cancel the 2-point teaching mode and return the system to the teaching mode select display.



CAUTION

In principle, the teaching operation should be performed outside the dangerous area of the robot. If it should be performed inevitably within the dangerous area, strictly observe the following matters.

- (1) The teaching operation should always be performed by two (2) persons. One person performs the job and the other person watches outside the dangerous area. Also, both persons should try to prevent mis-operation with each other.
- (2) The operator should do the job in an attitude ready to press the EMERGENCY stop pushbutton switch at any time. Also, he should perform the job at a position from which he can evacuate immediately at the time of emergency after confirming the robot working range and shields nearby.
- (3) The supervisor should keep watch on the job at a position where he can see the entire robot system and operate the EMERGENCY stop pushbutton switch at the time of an emergency. Also, he should keep anyone from entering the dangerous area.

Press the EXE key or  key, and the following display appears.

Assume that you are going to teach the X-axis plus (+) direction on this display.

T	R	A	N	S	0	0	0	0	2											[3	/	1	1]
X :					5	0	0	.	0	0	0														
Y :					0	.	0	0	0	0															
Z :					0	.	0	0	0	0															
C :					0	.	0	0	0	0															
2 p — t e a c h / d i r e c t i o n :																									

Guide the robot tool tip so that it can be located in the X-axis plus (+) direction of the coordinate system you wish to teach.

Keys operative in this mode and their operations are shown below.

Key	Descriptions
EXE	Used to register a coordinate indicating the X-axis plus (+) direction, which is located on a straight line connecting the origin of a new coordinate system as defined by origin setting with a current position of the robot.
ESC	Used to cancel the 2-point teaching mode and return the system to the teaching mode select display.

Press the EXE key, and the coordinate indicating the X-axis plus (+) direction, which is located on the straight line connecting the origin of the new coordinate system as defined by origin setting with the current position of the robot, is registered.

For instance, when the current coordinates of the robot are,

```

X      100.000
Y      100.000
Z      100.000
    
```

the display is as shown below.

T R A N S 0 0 0 0 2										[3 / 1 1]			
X :	1	0	0	.	0	0	0						
Y :	1	0	0	.	0	0	0						
Z :	1	0	0	.	0	0	0						
C :		0	.	0	0	0							
T R A N S 0 0 0 0 2													
S A V E			T E A C H			D I R			W O R K		F I N D		>

5.6 Load Data Display Mode

The load data display mode displays the mass and center of gravity offset of a load used to control the gain and acceleration. In this mode, it is possible to add, delete, and change the load data.

An example of the display is given below.















	L O A D	W E I G H T	O F F S E T
↑	L O A D 0 0 0 0 0 3 =	1 0 0 . 0 0 0 ,	1 0 0 . 0 0 0
	L O A D 0 0 0 0 0 4 =	2 0 0 . 0 0 0 ,	0 . 0 0 0
	L O A D 0 0 0 0 0 5 =	5 0 . 0 0 0 ,	0 . 0 0 0
	L O A D 0 0 0 0 0 6 =	5 0 . 0 0 0 ,	0 . 0 0 0
↓	L O A D 0 0 0 0 0 7 =	5 0 . 0 0 0 ,	0 . 0 0 0
L O A D 0 0 0 0 0 5			
SAVE PRG POINT TRANS FIND >			

Each time the NEXT key is pressed, the menu is changed over as follows:

<	N O S A V	C U T	P A S T E	 	 	 	 	
---	---	---	---	---	---	---	---	---

- An inversely displayed section in the data is called the "main cursor" which indicates that this data is selected for editing.
- Symbol "↑" shown in the 1st column signifies that there is load data before the top data.
- Symbol "↓" shown in the 1st column signifies that there is load data after the final data.
- "WEIGHT" represents the mass of a load (in kg).
- "OFFSET" represents the horizontal length (in mm) between the gravity center of a load and the tool shaft center.
- The load data should include the tool own load.

Keys operative in this mode and their operations are shown below.

Key	Descriptions
	Used to move the main cursor left.
	Used to move the main cursor right.
	Used to move the main cursor up.
	Used to move the main cursor down.
 + 	Used to move the main cursor up on the screen basis.
 + 	Used to move the main cursor down on the screen basis.
	Used to create a new load data just after the main cursor line.
 + 	Used to delete a load data indicated by the main cursor.
	Used to edit a data indicated by the main cursor.
	Used to toggle the menu (resulting in the next menu).
 + 	Used to toggle the menu (resulting in the previous menu).

Operations of each menu are shown below.

Menu	Descriptions
[SAVE]	Used to save a data and quit the data editor. (When the data editor was started up from the program editor, the program editor terminates also.)
[PRG]	Used to select the program editor display. If the data editor was started up, however, the display will not change over.
[TRANS]	Used to select the coordinate data display.
[POINT]	Used to select the positional data display.
[FIND]	Used to search a mode name.
[NOSAV]	Used to quit the editor without saving data. All changed data are aborted. (When the data editor was started up from the program editor, the program editor terminates also.)
[CUT]	Used to select the range select mode.
[PASTE]	Used to paste the contents saved in the cut buffer (i.e., data deleted by the previous cut menu) after a load data indicated by the main cursor to clear the cut buffer.

Each menu of [SAVE], [PRG], [FIND], [NOSAV], [CUT] and [PASTE] is the same as in the positional data directory display mode and is not described in this paragraph.

5.6.1 Editing of Load Data Name

(1) Function

Edits a load data name.

(2) Procedures

When you press the EXE key while the main cursor is located at the load name, you can edit the load name.

In the example below, assume that you are going to change the name of "LOAD000005" to "LOAD000055."

(a) Step 1: Data selection.

Move the main cursor to "LOAD000005" by means of the cursor keys (↑, ↓, →, ←), and the following display appears.

	L O A D	W E I G H T	O F F S E T
↑	L O A D 0 0 0 0 0 3 =	1 0 0 . 0 0 0 ,	1 0 0 . 0 0 0
	L O A D 0 0 0 0 0 4 =	2 0 0 . 0 0 0 ,	0 . 0 0 0
	L O A D 0 0 0 0 0 5 =	5 0 . 0 0 0 ,	0 . 0 0 0
	L O A D 0 0 0 0 0 6 =	5 0 . 0 0 0 ,	0 . 0 0 0
↓	L O A D 0 0 0 0 0 7 =	5 0 . 0 0 0 ,	0 . 0 0 0
L O A D 0 0 0 0 0 5			
S A V E P R G P O I N T T R A N S F I N D >			

Press the EXE key, and the following display is called. (The cursor is displayed on the command line.)

	L O A D	W E I G H T	O F F S E T
↑	L O A D 0 0 0 0 0 3 =	1 0 0 . 0 0 0 ,	1 0 0 . 0 0 0
	L O A D 0 0 0 0 0 4 =	2 0 0 . 0 0 0 ,	0 . 0 0 0
	L O A D 0 0 0 0 0 5 =	5 0 . 0 0 0 ,	0 . 0 0 0
	L O A D 0 0 0 0 0 6 =	5 0 . 0 0 0 ,	0 . 0 0 0
↓	L O A D 0 0 0 0 0 7 =	5 0 . 0 0 0 ,	0 . 0 0 0
L O A D 0 0 0 0 0 5 _			
S A V E P R G P O I N T T R A N S F I N D >			









- Current load name is displayed as the initial data on the command line.
- The cursor on the command line is displayed next to the initially displayed name, and you can edit the data.
- When the cursor is shown by the mark "■", the replace mode takes effect. When the cursor is shown by the mark "_", the insert mode is effective.

(b) Step 2: Data name input.

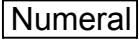
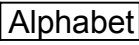
Enter a desired name to the command line, using alphanumeric keys, → key, and ← key. Then the following display appears.

	L O A D	W E I G H T	O F F S E T
↑	L O A D 0 0 0 0 0 3 =	1 0 0 . 0 0 0 ,	1 0 0 . 0 0 0
	L O A D 0 0 0 0 0 4 =	2 0 0 . 0 0 0 ,	0 . 0 0 0
	L O A D 0 0 0 0 0 5 =	5 0 . 0 0 0 ,	0 . 0 0 0
	L O A D 0 0 0 0 0 6 =	5 0 . 0 0 0 ,	0 . 0 0 0
↓	L O A D 0 0 0 0 0 7 =	5 0 . 0 0 0 ,	0 . 0 0 0
L O A D 0 0 0 0 5 5 _			
SAVE PRG POINT TRANS FIND >			

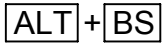
Keys operative in this mode and their operations are shown below.

Key	Descriptions
	Used to move the cursor left on the command line.
	Used to move the cursor right on the command line.
 	Used to input characters on the command line.
	Used to change current load name to an entered one. The system returns to the load data display mode with the cursor moved to "WEIGHT".
	Used to select the insert or replace mode for the command line.
	Used to delete one (1) character just before the cursor position on the command line.
	Used to delete one (1) character at the cursor position on the command line.
	This function works in a different manner according to the presence or absence of input character(s). Presence of input character(s): All input character(s) on the command line are cleared. Absence of input character(s): The system returns to the load data display.

Press the EXE key, and the load name is replaced by the newly specified name. The following display appears.

	L O A D	W E I G H T	O F F S E T
↑	L O A D 0 0 0 0 0 3 =	1 0 0 . 0 0 0 ,	1 0 0 . 0 0 0
	L O A D 0 0 0 0 0 4 =	2 0 0 . 0 0 0 ,	0 . 0 0 0
	L O A D 0 0 0 0 0 5 5 =	5 0 . 0 0 0 ,	0 . 0 0 0
	L O A D 0 0 0 0 0 6 =	5 0 . 0 0 0 ,	0 . 0 0 0
↓	L O A D 0 0 0 0 0 7 =	5 0 . 0 0 0 ,	0 . 0 0 0
5 0 . 0 0 0			
S A V E P R G P O I N T T R A N S F I N D >			

- The main cursor moves to the "WEIGHT" data area.
- If the input name is illegal, a message saying "ILLEGAL NAME" is displayed on the command line and no data is changed.
- If the specified name already exists, a message of "DUPLICATE NAME" is displayed on the command line and no data is changed.

5.6.2 Editing of Load Data Element

(1) Function

Used to edit a load data element.

(2) Procedures

When you press the EXE key while the main cursor is located at each load element, you can edit that data.

In the example below, assume that you are going to change the weight data of "LOAD000005" from "50.000" to "100".

(a) Step 1: Data selection.

Move the main cursor to the data you wish to edit by means of the cursor keys (↑, ↓, →, ←), and the following display appears.

	L O A D	W E I G H T	O F F S E T
↑	L O A D 0 0 0 0 0 3 =	1 0 0 . 0 0 0 ,	1 0 0 . 0 0 0
	L O A D 0 0 0 0 0 4 =	2 0 0 . 0 0 0 ,	0 . 0 0 0
	L O A D 0 0 0 0 0 5 =	5 0 . 0 0 0 ,	0 . 0 0 0
	L O A D 0 0 0 0 0 6 =	5 0 . 0 0 0 ,	0 . 0 0 0
↓	L O A D 0 0 0 0 0 7 =	5 0 . 0 0 0 ,	0 . 0 0 0
5 0 . 0 0 0			
SAVE PRG POINT TRANS FIND >			

Press the EXE key, and the following display is called. (The cursor is displayed on the command line.)

	L O A D	W E I G H T	O F F S E T
↑	L O A D 0 0 0 0 0 3 =	1 0 0 . 0 0 0 ,	1 0 0 . 0 0 0
	L O A D 0 0 0 0 0 4 =	2 0 0 . 0 0 0 ,	0 . 0 0 0
	L O A D 0 0 0 0 0 5 =	5 0 . 0 0 0 ,	0 . 0 0 0
	L O A D 0 0 0 0 0 6 =	5 0 . 0 0 0 ,	0 . 0 0 0
↓	L O A D 0 0 0 0 0 7 =	5 0 . 0 0 0 ,	0 . 0 0 0
5 0 . 0 0 0 _			
SAVE PRG POINT TRANS FIND >			

- Current data is displayed as the initial value on the command line.
- The cursor on the command line is displayed next to the initially displayed data, and you can edit the data.
- When the cursor is shown by the mark "■", the replace mode takes effect. When the cursor is shown by the mark "_", the insert mode is effective.

(b) Step 2: Data input.

Enter a desired value to the command line, using alphanumeric keys, → key, and ← key. Then the following display appears.

	L O A D	W E I G H T	O F F S E T
↑	L O A D 0 0 0 0 0 3 =	1 0 0 . 0 0 0 ,	1 0 0 . 0 0 0
	L O A D 0 0 0 0 0 4 =	2 0 0 . 0 0 0 ,	0 . 0 0 0
	L O A D 0 0 0 0 0 5 =	5 0 . 0 0 0 ,	0 . 0 0 0
	L O A D 0 0 0 0 0 6 =	5 0 . 0 0 0 ,	0 . 0 0 0
↓	L O A D 0 0 0 0 0 7 =	5 0 . 0 0 0 ,	0 . 0 0 0
1 0 0 _			
SAVE PRG POINT TRANS FIND >			

Keys operative in this mode and their operations are shown below.

Key	Descriptions
	Used to move the cursor left on the command line.
	Used to move the cursor right on the command line.
Numeral 	Used to input characters on the command line.
EXE	Used to change current load element to an entered one. The system returns to the display mode with the main cursor moved to the next data area.
INS	Used to select the insert or replace mode for the command line.
BS	Used to delete one (1) character just before the cursor position on the command line.
ALT + BS	Used to delete one (1) character at the cursor position on the command line.
ESC	This function works in a different manner according to the presence or absence of input character(s). Presence of input character(s): All input character(s) on the command line are cleared. Absence of input character(s): The system returns to the load data display.

Press the EXE key, and the load element is replaced by the newly specified data. The system returns to the load data display mode with the main cursor moved to the next data area. The display is as shown below.

	L O A D	W E I G H T	O F F S E T
↑	L O A D 0 0 0 0 0 3 =	1 0 0 . 0 0 0 ,	1 0 0 . 0 0 0
	L O A D 0 0 0 0 0 4 =	2 0 0 . 0 0 0 ,	0 . 0 0 0
	L O A D 0 0 0 0 0 5 =	1 0 0 . 0 0 0 ,	0 . 0 0 0
	L O A D 0 0 0 0 0 6 =	5 0 . 0 0 0 ,	0 . 0 0 0
↓	L O A D 0 0 0 0 0 7 =	5 0 . 0 0 0 ,	0 . 0 0 0
	0 . 0 0 0		
	S A V E	P R G	P O I N T T R A N S F I N D >

5.6.3 Addition of New Load Data [INS]

(1) Function

Adds new load data.

(2) Procedures

Assume that you are going to add a new load data ("LOAD000010") just after "LOAD000005."

(a) Step 1: Selection of newly added data position

Move the main cursor to "LOAD000005", and the following display is called.

	L O A D	W E I G H T	O F F S E T
↑	L O A D 0 0 0 0 0 3 =	1 0 0 . 0 0 0 ,	1 0 0 . 0 0 0
	L O A D 0 0 0 0 0 4 =	2 0 0 . 0 0 0 ,	0 . 0 0 0
	L O A D 0 0 0 0 0 5 =	5 0 . 0 0 0 ,	0 . 0 0 0
	L O A D 0 0 0 0 0 6 =	5 0 . 0 0 0 ,	0 . 0 0 0
↓	L O A D 0 0 0 0 0 7 =	5 0 . 0 0 0 ,	0 . 0 0 0
	L O A D 0 0 0 0 0 5		
	S A V E	P R G	P O I N T T R A N S F I N D >

(b) Step 2: Data creation.

Press the INS key, and the display changes as shown below with the name input mode selected.

	L O A D	W E I G H T	O F F S E T
↑	L O A D 0 0 0 0 0 3 =	1 0 0 . 0 0 0 ,	1 0 0 . 0 0 0
	L O A D 0 0 0 0 0 4 =	2 0 0 . 0 0 0 ,	0 . 0 0 0
	L O A D 0 0 0 0 0 5 =	5 0 . 0 0 0 ,	0 . 0 0 0
	[REDACTED]	0 . 0 0 0 ,	0 . 0 0 0
↓	L O A D 0 0 0 0 0 6 =	5 0 . 0 0 0 ,	0 . 0 0 0
-	L O A D 0 0 0 0 0 5		
	S A V E	P R G	P O I N T T R A N S F I N D >

Enter a desired name ("LOAD000010" in this example) and press the EXE key. The display changes as follows:

	L O A D	W E I G H T	O F F S E T
↑	L O A D 0 0 0 0 0 3 =	1 0 0 . 0 0 0 ,	1 0 0 . 0 0 0
	L O A D 0 0 0 0 0 4 =	2 0 0 . 0 0 0 ,	0 . 0 0 0
	L O A D 0 0 0 0 0 5 =	5 0 . 0 0 0 ,	0 . 0 0 0
	L O A D 0 0 0 0 1 0 =	0 . 0 0 0 ,	0 . 0 0 0
↓	L O A D 0 0 0 0 0 6 =	5 0 . 0 0 0 ,	0 . 0 0 0
	0 . 0 0 0		
	S A V E	P R G	P O I N T T R A N S F I N D >

(3) Cautions

- For the newly added load data, zero (0) is set for all elements.
- When you have pressed the ESC key without specifying the name, addition of the new data is canceled and the system returns.

5.6.4 Deletion of Load Data (ALT + BS)

(1) Function

Deletes load data.

(2) Procedures

Assume that you are going to delete the data of "LOAD000005".

(a) Step 1: Delete

Move the main cursor to "LOAD000005", and the following display is called.

	L O A D	W E I G H T	O F F S E T
↑	L O A D 0 0 0 0 0 3 =	1 0 0 . 0 0 0 ,	1 0 0 . 0 0 0
	L O A D 0 0 0 0 0 4 =	2 0 0 . 0 0 0 ,	0 . 0 0 0
	L O A D 0 0 0 0 0 5 =	5 0 . 0 0 0 ,	0 . 0 0 0
	L O A D 0 0 0 0 0 6 =	5 0 . 0 0 0 ,	0 . 0 0 0
↓	L O A D 0 0 0 0 0 7 =	5 0 . 0 0 0 ,	0 . 0 0 0
L O A D 0 0 0 0 0 5			
	S A V E	P R G	P O I N T T R A N S F I N D >

Press the ALT and BS keys at the same time, and the following display appears with the specified data deleted.

	L O A D	W E I G H T	O F F S E T
↑	L O A D 0 0 0 0 0 3 =	1 0 0 . 0 0 0 ,	1 0 0 . 0 0 0
	L O A D 0 0 0 0 0 4 =	2 0 0 . 0 0 0 ,	0 . 0 0 0
	L O A D 0 0 0 0 0 6 =	5 0 . 0 0 0 ,	0 . 0 0 0
	L O A D 0 0 0 0 0 7 =	5 0 . 0 0 0 ,	0 . 0 0 0
↓	L O A D 0 0 0 0 0 8 =	0 . 0 0 0 ,	0 . 0 0 0
L O A D 0 0 0 0 0 5			
	S A V E	P R G	P O I N T T R A N S F I N D >

(3) Caution

You cannot undo data deleted by this operation.

5.6.5 Call of Positional Data Directory Display [POINT]

(1) Function

Displays the positional data directory display.

(2) Procedures

(a) Step 1: Command selection.

Select the data display mode as shown below (i.e., the cursor is not present on the command line).

	L O A D	W E I G H T	O F F S E T
↑	L O A D 0 0 0 0 0 3 =	1 0 0 . 0 0 0 ,	1 0 0 . 0 0 0
	L O A D 0 0 0 0 0 4 =	2 0 0 . 0 0 0 ,	0 . 0 0 0
	L O A D 0 0 0 0 0 5 =	5 0 . 0 0 0 ,	0 . 0 0 0
	L O A D 0 0 0 0 0 6 =	5 0 . 0 0 0 ,	0 . 0 0 0
↓	L O A D 0 0 0 0 0 7 =	5 0 . 0 0 0 ,	0 . 0 0 0
L O A D 0 0 0 0 0 5			
SAVE PRG POINT TRANS FIND >			

Press [POINT] and the following positional data directory display is called.

	P O I N T	X	Y	Z
	P O I N T 0 0 0 0 1 =	1 0 0 ,	1 0 0 ,	1 0 0 ,
	P O I N T 0 0 0 0 2 =	2 0 0 ,	2 0 0 ,	2 0 0 ,
	P O I N T 0 0 0 0 3 =	3 0 0 ,	3 0 0 ,	3 0 0 ,
	P O I N T 0 0 0 0 4 =	4 0 0 ,	4 0 0 ,	4 0 0 ,
↓	P O I N T 0 0 0 0 5 =	5 0 0 ,	5 0 0 ,	5 0 0 ,
P O I N T 0 0 0 0 1		w / . w o r l d		
SAVE PRG FULL TRANS PYLD >				

(3) Caution

On the positional data directory display, the main cursor indicates the position of the data displayed before.

For details of operations to be done on the positional data directory display, see Para. 5.2.

5.6.6 Call of Coordinate Data Directory Display [TRANS]

(1) Function

Calls the coordinate data directory display.

(2) Procedures

(a) Step 1: Command selection.

Select the data display mode as shown below (i.e., the cursor is not present on the command line).

	L O A D	W E I G H T	O F F S E T
↑	L O A D 0 0 0 0 0 3 =	1 0 0 . 0 0 0 ,	1 0 0 . 0 0 0
	L O A D 0 0 0 0 0 4 =	2 0 0 . 0 0 0 ,	0 . 0 0 0
	L O A D 0 0 0 0 0 5 =	5 0 . 0 0 0 ,	0 . 0 0 0
	L O A D 0 0 0 0 0 6 =	5 0 . 0 0 0 ,	0 . 0 0 0
↓	L O A D 0 0 0 0 0 7 =	5 0 . 0 0 0 ,	0 . 0 0 0
L O A D 0 0 0 0 0 5			
SAVE PRG POINT TRANS FIND >			

Press [TRANS], and the following coordinate data directory display appears.

T R A N S	S E L E C T I O N	[1 /	1 1]
. w o r l d			1 0	
T R A N S 0 0 0 0 1			1 0	
T R A N S 0 0 0 0 2			5	
T R A N S 0 0 0 0 3			0	
T R A N S 0 0 0 0 4			0	
. w o r l d				
SAVE PRG PYLD WORK TOOL >				

(3) Caution

On the coordinate data directory display, the main cursor indicates the position of the data displayed before.

For details of operations to be done on the coordinate data directory display, see Para. 5.4.

Section 6 Test Operation**DANGER**

NEVER enter the dangerous area of the robot during automatic operation. If you still have to enter the dangerous area, be sure to terminate the automatic operation and turn the servo power off beforehand.

**CAUTION**

1. Make sure that no obstacle stands in the robot working range. If any obstacle exists, perform automatic operation at a slow speed and make sure that the robot will not collide with the obstacle at all.
2. If the robot motion becomes abnormal during program execution, press the EMERGENCY stop pushbutton switch immediately to stop the robot. NEVER restart the automatic operation until the cause of the abnormality is identified.
3. The speed of automatic operation is initially set at 100% of the maximum robot speed.
4. When performing automatic operation after power ON, reset the program for the automatic operation in advance. If the program is executed continuously, the robot will collide with the peripheral equipment, resulting in damage of the equipment and an accident.

6.1 Selecting Test Operation Mode

- (1) Function
Selects the test operation mode where you can execute a program partially or wholly to verify the program.
- (2) Procedures
 - (a) Step 1: Selection of teaching mode.
Change over the MODE switch equipped on the control panel to "TEACHING."

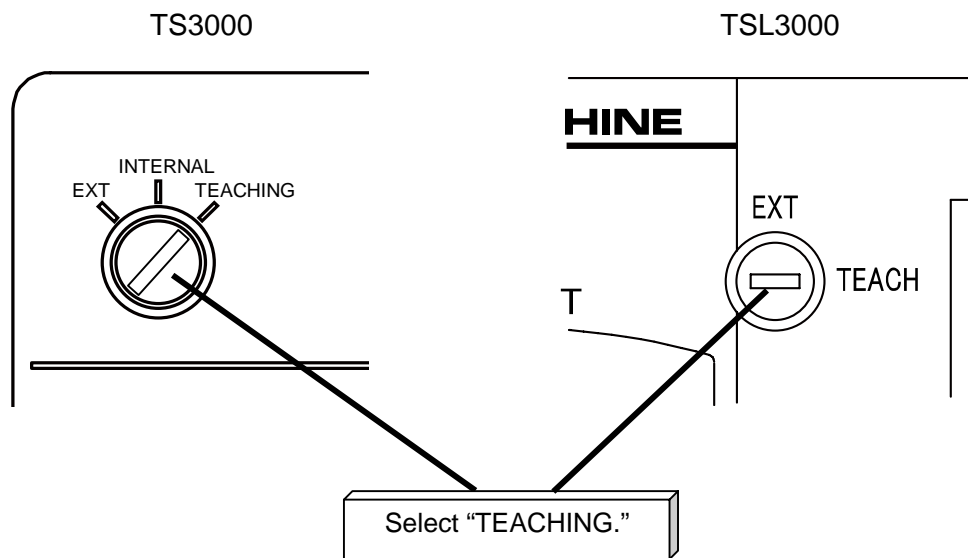

- (b) Step 2: Selection of test operation mode.
When the teaching mode is selected, the test operation display of the teaching mode is called, as shown below.

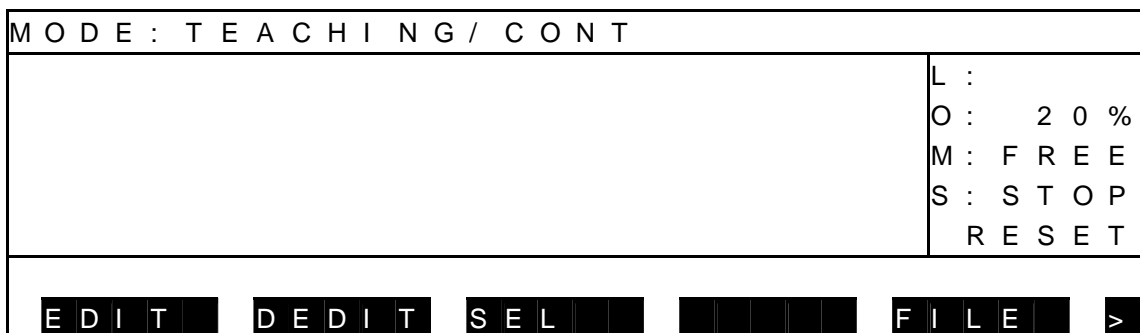

Each time the NEXT key is pressed, the menu is changed as shown below.



Descriptions on display

- [1] MODE: Indicates the currently selected master mode and run mode.
 - CONT : Continuous operation
 - CYCLE : Cycle operation
 - SEG : Segment operation
 - STEP : Step operation
- [2] Right side on the 1st line: Displays active file name.
- [3] L: No. of execution steps
- [4] O: Speed override
- [5] M: Machine status
 - FREE : Machine lock OFF status
- [6] S: Execution status
 - RUN : A program is currently executed.
 - STOP RESET : A program is stopped in the initialize mode.
This is the same as the program reset.
 - STOP RETRY : A program is stopped in the restart mode.
It is restarted from the interrupted motion.
 - STOP CONT : A program is stopped in the continue mode.
It is restarted from the current program step.
- [7] Bottom line: Function key menu display field
 - [EDIT] : Program editing
 - [DEDIT] : Data editing
 - [SEL] : Selection of program to be executed
 - [RUN] : Test operation start
 - [FILE] : File mode
 - [MODE] : Run mode selection
 - [OVRD] : Override setting
 - [RESET] : Reset
 - [DO] : Direct execution
 - [WATCH] : Variable monitor
 - [STOP] : Stop
 - [BREAK] : Interruption
 - [LDISP] : Display of line to be executed

6.2 Selecting File [SEL]

- (1) Function
Selects a file (or program) to be executed.
- (2) Procedures
 - (a) Step 1: Command selection.
Press the function key corresponding to the [SEL] menu. Unless the [SEL] menu is available, press the NEXT key repeatedly until [SEL] is displayed in the menu.

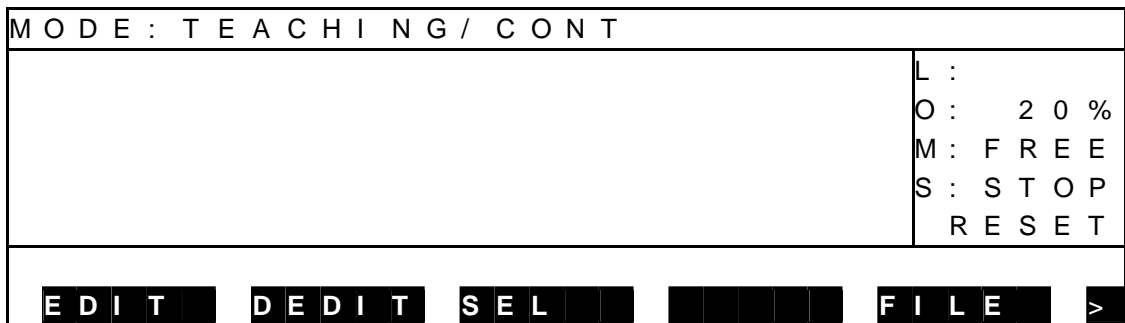

- (b) Step 2: Input of file name.
When the file directory is displayed, inversely display and select a desired file name, using the up and down cursor keys, then press the EXE key. [NAME] and [TIME] in the menu are used to sort the file directory by name and time, respectively. To directly enter the file name through the keyboard, press the [INPUT] function key and input the file name you wish to execute. If the file name contains an extension, be sure to input the extension also.

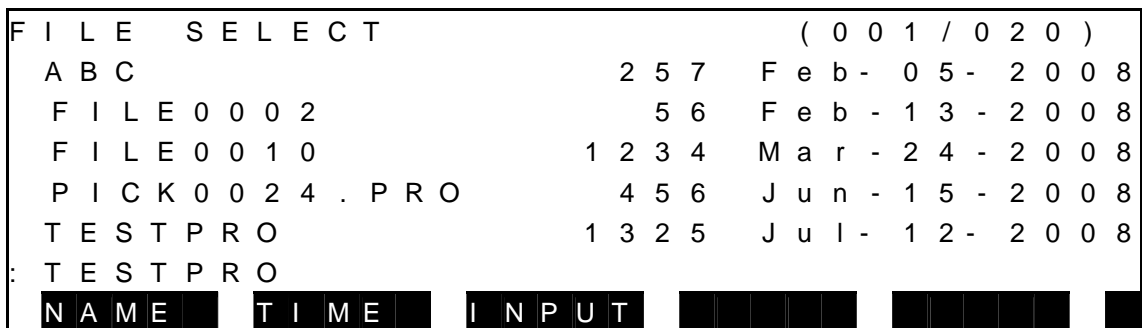

* If mark * precedes a file name and this file name is inversely displayed on the file select screen, it is the execution file already selected.

(c) Step 3: Input through EXE key.

Make sure that your entry is correct, and press the EXE key. Then the specified file name is displayed in the execution file display field on the 1st line at the same time that [RUN] is displayed in the menu to indicate that you can start a test operation.

MODE : T E A C H I N G / C O N T										T E S T P R O									
															L :				
															O : 2 0 %				
															M : F R E E				
															S : S T O P				
															R E S E T				
E D I T			D E D I T			S E L			R U N			F I L E			>				

(3) Cautions

- Once the execution file has been selected, it remains effective until another file is selected.
- If a compile error has occurred, however, selection of the execution file is canceled.
- When another file has been selected, the execution environment of automatic operation is reset.
- To reset the execution environment without changing the execution file, press the NEXT key followed by [RESET] and [PROG].

6.3 Selecting Run Mode [MODE]

- (1) Function
Changes over the run mode of automatic operation.
- (2) Procedures
 - (a) Step 1: Command selection.
Press the NEXT key repeatedly until [MODE] is displayed in the menu.
Press the corresponding function key then.

MODE : T E A C H I N G / C O N T T E S T P R O									
								L :	
								O :	2 0 %
								M :	F R E E
								S :	S T O P
									R E S E T
<div style="display: flex; justify-content: space-between; padding: 0;"> MODE OV RD RE SET DO WATCH > </div>									

- (b) Step 2: Mode selection.
Select a desired run mode from the menu.

MODE : T E A C H I N G / C O N T T E S T P R O									
								L :	
								O :	2 0 %
								M :	F R E E
								S :	S T O P
									R E S E T
MODE : C Y C L E									
<div style="display: flex; justify-content: space-between; padding: 0;"> CONT CY CLE SEG STEP </div>									

- [CONT] : Repeats program execution continuously.
- [CYCLE] : Stops program execution at the end of the program.
- [SEG] : Stops program execution just before the next motion command.
- [STEP] : Executes a program each time one program step has been executed.

(c) Step 3: Input through EXE key.

Make sure that your entry is correct, and press the EXE key. If you have entered a wrong data, press the ESC key to cancel the entry and select again. Then the specified run mode is shown on the display.

M O D E : T E A C H I N G / C Y C L E T E S T P R O	
	L : O : 2 0 % M : F R E E S : S T O P R E S E T
M O D E	O V R D R E S E T D O W A T C H >

(3) Cautions

- The run mode can be selected even while the program is being executed.
- The execution mode selected is also operative in both the internal automatic mode and external automatic mode.
- The selected run mode remains valid until another run mode is selected.
- If the stop command is executed in the program, program execution stops, irrespective of the run mode currently selected.

6.4 Speed Override [OVRD]

(1) Function

Sets the speed override for automatic operation. This function is useful to effect an additional override, taking the programmed speed as 100%.

(2) Procedures

(a) Step 1: Command selection.

Press the NEXT key repeatedly until [OVRD] is displayed in the menu.
Press the corresponding function key then.

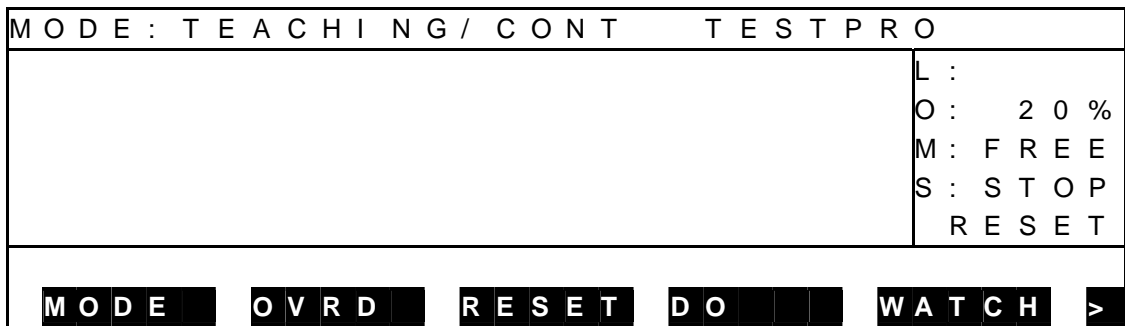

(b) Step 2: Input of speed override.

Set an override of 1 ~ 100 on the speed by means of the appropriate function key.

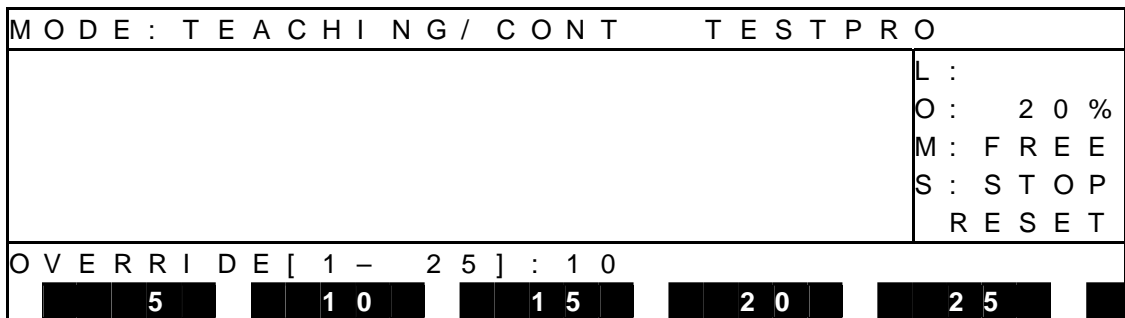

* The maximum override for the teaching mode can be specified by the user parameter. In the teaching mode, a set value MUST NOT exceed this maximum value.

(c) Step 3: Input through EXE key.

Make sure that your entry is correct, and press the EXE key. Then the specified override value is shown under "O:" on the display.

M O D E : T E A C H I N G / C O N T										T E S T P R O									
										L :									
										O : 1 0 %									
										M : F R E E									
										S : S T O P									
										R E S E T									
M O D E			O V R D			R E S E T			D O			W A T C H			>				

(3) Cautions

- The specified speed override is also operative in both the internal automatic mode and external automatic mode.
- The selected override remains valid until another override is specified.

(4) Related matter

The speed can be limited by the external signal ("low speed command"). When this happens, the motion speed can be specified by the user parameter. If the override speed set exceeds this low speed, it is clamped there. The external signal (low speed command) also takes effect in both the internal automatic mode and external automatic mode.

6.5 Executing Program Step [STEP]

- (1) Function
Executes a test operation in the STEP mode in which a program is stopped each time a step has been executed.
- (2) Procedures
 - (a) Step 1: Setting of running conditions.
Set the conditions for executing the file selection and speed override setting.
 - (b) Step 2: Command selection.
Press the NEXT key repeatedly until [MODE] is displayed in the menu.
Press the corresponding function key then.

MODE : T E A C H I N G / C O N T										T E S T P R O									
										L :									
										O : 2 0 %									
										M : F R E E									
										S : S T O P									
										R E S E T									
M O D E		O V R D		R E S E T		D O				W A T C H		>							

- (c) Step 3: Mode selection.
Select [STEP] from the menu.

MODE : TEACHING / CONT TESTPRO	
	L : O : 20 % M : FREE S : STOP RESET
MODE : STEP	
CONT	CYCLE
SEG	STEP

- (d) Step 4: Input through EXE key.
Make sure that your entry is correct, and press the EXE key. The step operation mode is selected then.

MODE : TEACHING / STEP TESTPRO	
OK	L : O : 20 % M : FREE S : STOP RESET
MODE	OVRD
RESET	DO
WATCH	>

- (e) Step 5: Execution of RUN.
Select [RUN] from the menu by means of the NEXT key, then press the EXE key.

MODE : TEACHING / STEP TESTPRO	
	L : O : 20 % M : FREE S : STOP CONT
MOVE A 1	

(f) Step 6: Execution.

When the program step you wish to execute is displayed in the command input field, press the EXE key. After executing the displayed step, the system waits for the next input through the EXE key, displaying the next program step. Press the EXE key, and the next step is executed.

M O D E : T E A C H I N G / S T E P										T E S T P R O									
															L :				
															O : 2 0 %				
															M : F R E E				
															S : S T O P				
															C O N T				
M O V E A 2																			
■ ■ ■ ■ ■ ■ ■ ■ ■ ■										■ ■ ■ ■ ■ ■ ■ ■ ■ ■									
■ ■ ■ ■ ■ ■ ■ ■ ■ ■										■ ■ ■ ■ ■ ■ ■ ■ ■ ■									
■ ■ ■ ■ ■ ■ ■ ■ ■ ■										■ ■ ■ ■ ■ ■ ■ ■ ■ ■									
■ ■ ■ ■ ■ ■ ■ ■ ■ ■										■ ■ ■ ■ ■ ■ ■ ■ ■ ■									

(3) Cautions

- To stop the step operation, press the ESC key to quit.
- To execute a step in another run mode, select the run mode again.
- During step execution, a step to be executed is displayed in the command filed of the teach pendant.
- If a step operation is executed, using a multitask program, tasks are not changed over.
- The TASK command, SWITCH command or any other command related to the multitask is not executed, either.

6.6 Startup [RUN]

(1) Function

Starts a test operation under the predetermined conditions. This function is used to verify a newly created program and to restart an interrupted program.

(2) Procedures

(a) Step 1: Setting of running conditions.

Set the conditions for executing the file selection, run mode selection speed override setting.

(b) Step 2: Command selection.

Press the NEXT key repeatedly until [RUN] is displayed in the menu. Press the corresponding function key then.

M O D E : T E A C H I N G / C O N T										T E S T P R O										
															L :					
															O : 2 0 %					
															M : F R E E					
															S : S T O P					
															R E S E T					
R U N																				
E D I T				D E D I T				S E L				R U N				F I L E				>

(c) Step 3: Input through EXE key.

Press the EXE key. When execution of a program is started, the RUN LED on the controller front panel turns on. (In the TS3000, the STOP LED turns off at the same time.)

During the program execution, the display of the teach pendant is as shown below with "RUN" indicated under "S" (execution status).

M O D E : T E A C H I N G / C O N T		T E S T P R O		
		L :	1 7	
		O :	2 0 %	
		M :	F R E E	
		S :	R U N	
M O D E	O V R D	B R E A K	S T O P	W A T C H

(3) Cautions

- To execute a program from the top, execute [RESET] and [PROG] followed by [RUN].

6.7 Stop

6.7.1 CYCLE Stop

(1) Function

Selects "CYCLE" for the run mode and stops an automatic operation at the program end. This function is used to stop the robot after the end of an operation.

(2) Procedures

(a) Step 1: Command selection.

Press the NEXT key repeatedly until [MODE] is displayed in the menu, and press the corresponding function key.

MODE : T E A C H I N G / C O N T		T E S T P R O	
		L :	1 8 0
		O :	2 0 %
		M :	F R E E
		S :	R U N
MODE	OVRD	BREAK	STOP
WATCH			

(b) Step 2: Mode selection.

Select "CYCLE" from the menu.

MODE : T E A C H I N G / C O N T		T E S T P R O	
		L :	1 8 8
		O :	2 0 %
		M :	F R E E
		S :	R U N
MODE : C Y C L E			
CONT	CYCLE	SEG	STEP

(c) Step 3: Input through EXE key.

Make sure that your entry is correct, and press the EXE key. The CYCLE switch LED equipped on the control panel is illuminated with "CYCLE" shown under "S" (execution status) on the teach pendant display. When the program has been executed to the end, the automatic operation stops. When stopped, the RUN LED on the controller front panel turns off. (In the TS3000, the STOP LED turns on at the same time.) Also, "STOP (CONT)" is indicated for "S" (execution status) on the teach pendant display.

M O D E : T E A C H I N G / C Y C L E T E S T P R O							
	L : 2 1 5						
	O : 2 0 %						
	M : F R E E						
	S : S T O P						
	C O N T						
<table border="1"> <tr> <td>E D I T</td> <td>D E D I T</td> <td>S E L</td> <td>R U N</td> <td>F I L E</td> <td>></td> </tr> </table>		E D I T	D E D I T	S E L	R U N	F I L E	>
E D I T	D E D I T	S E L	R U N	F I L E	>		

(3) Cautions

- The "cycle stop" external control signal are inoperative in the cycle operation mode.
- The SCOL program execution unit pre-reads up to four (4) motion commands. Therefore, the program may be executed successively by up to three (3) cycles according to the cycle stop timing or the active program contents.

6.7.2 STOP

(1) Function

Stops an automatic operation when the active command has been executed. This function is used for normal stop operations.

(2) Procedures

(a) Step 1: Input of STOP.

- Teach pendant: Press the function key corresponding to the [STOP] menu.
- *In the TS3000, automatic operation can also be stopped by pressing the STOP switch on the controller front panel.

MODE : TEACHING / CONT TEST PRO	
	L : 17 O : 20 % M : FREE S : RUN
<div style="display: flex; justify-content: space-around; text-align: center;"> MODE OVRD BREAK STOP WATCH </div>	

After STOP is input, when the currently executed command has completed, the automatic operation stops. (In the TS3000, when STOP is input, the STOP LED on the controller front panel turns on.) At the same time the RUN LED on the controller front panel turns off with "STOP (CONT)" shown under "S" (execution status) on the teach pendant display.

MODE : TEACHING / CONT TEST PRO	
	L : 115 O : 20 % M : FREE S : STOP CONT
<div style="display: flex; justify-content: space-around; text-align: center;"> EDIT DEDIT SEL RUN FILE > </div>	

(3) Cautions

- In the test operation mode, the "stop" external control signal is inoperative.
- To restart, press [RUN] followed by the EXE key.

6.7.3 BREAK

(1) Function

Immediately decelerates and stops the robot, and stops an automatic operation. This function is used to interrupt the automatic operation.

(2) Procedures

(a) Step 1: Input of BREAK.

Press the function key corresponding to the [BREAK] menu.

When BREAK is input, the robot immediately slows down and stops to stop the automatic operation.

(In the TS3000, when BREAK is input, the STOP LED on the controller front panel turns on.)

MODE : TEACHING / CONT		TEST PRO	
		L :	1 7
		O :	2 0 %
		M :	F R E E
		S :	R U N
MODE	OV RD	BREAK	STOP
WATCH			

When automatic operation is stopped, the RUN LED on the controller front panel turns off.

"STOP (RETRY)" is shown under "S" (execution status) on the teach pendant display.

MODE : TEACHING / CONT		TEST PRO	
		L :	1 1 5
		O :	2 0 %
		M :	F R E E
		S :	S T O P
			R E T R Y
EDIT	DEDIT	SEL	RUN
FILE			>

(3) Cautions

- During program execution in the step mode, the BREAK function is inoperative.

- To stop the step operation, press the EMERGENCY stop key or FEED HOLD key.
- To restart the operation after the break, press [RUN] followed by the EXE key.

6.7.4 FEED HOLD

(1) Function

Holds robot motion and program execution. When this function is specified during robot operation, the robot immediately slows down and stops. The feed hold function is used to stop the robot temporarily.

(2) Procedures

(a) Step 1: Input of FEED HOLD.

Press the FEED HOLD pushbutton switch equipped on the teach pendant, and the FEED HOLD switch LED is illuminated. If the robot is working, it decelerates and stops. (In the TS3000, when FEED HOLD is input, the STOP LED on the controller front panel turns on.)

When automatic operation is stopped, the RUN LED on the controller front panel turns off.

The display of the teach pendant is as shown below with "STOP (RETRY)" indicated under "S" (execution status).

MODE : T E A C H I N G / C O N T										T E S T P R O									
															L : 1 7				
															O : 2 0 %				
															M : F R E E				
															S : S T O P				
															R E T R Y				
E D I T			D E D I T			S E L			R U N			F I L E			>				

(b) Step 2: Cancel of [FEED HOLD].

While the FEED HOLD switch LED is turned on, press the FEED HOLD switch again. The [RUN] menu cannot be canceled.

The FEED HOLD switch LED turns off and automatic operation, step execution, direct execution and manual guidance become operative.

If feed hold was commanded during program execution, program execution can be restarted by canceling the feed hold.

When execution is restarted, the RUN LED on the controller front panel turns on.

(In the TS3000, when FEED HOLD is canceled, the STOP LED on the controller front panel turns off.)

"RUN" is shown under "S" (execution status) on the teach pendant display.

M O D E : T E A C H I N G / C O N T		T E S T P R O	
		L :	1 9
		O :	2 0 %
		M :	F R E E
		S :	R U N
M O D E	O V R D	B R E A K	S T O P
W A T C H			

(3) Cautions

- In the feed hold mode, automatic operation, step execution, direct execution, home return and manual guidance are invalid.
- When the FEED HOLD switch is pressed again, feed hold is canceled.
- If the feed hold was commanded during program execution, program execution can be restarted by canceling the feed hold. When the test operation has finished, program execution will not restart.

6.7.5 EMERGENCY Stop

(1) Function

Turns off the servo power and stops an automatic operation. This function is useful to stop the robot system at the time of an emergency.

(2) Procedures

Press the EMERGENCY stop pushbutton switch equipped on the teach pendant, or use the "emergency stop" external control signal.

(The TS3000 can also be stopped by the emergency stop switch on the controller front panel.)

When an emergency stop is input, the servo power is turned off, and the LED of the SERVO ON switch of the teach pendant turns off.

Also, the SERVO ON (SVON in the TSL3000) LED on the controller front panel turns off.

(In the TS3000, the SERVO OFF LED turns on at the same time.)

(3) Cautions

- All of the EMERGENCY stop switches on the control panel and teach pendant, and "emergency stop" external control signal are operative.
- At the time of an emergency, use whichever key you can get at quickest.
- The EMERGENCY stop switches on the control panel and teach pendant are of a lock type.
- When pressed, they remain depressed and locked. To reset, turn and unlock the switch.
- While the EMERGENCY stop switch is ON, the servo power cannot be turned on.

6.8 Reset [RESET]

The reset operation comes in the following five (5) modes. Any mode other than (4) cannot be reset unless a file for execution is selected.

- (1) Program reset
- (2) Step reset
- (3) Cycle reset
- (4) Output signal reset
- (5) Execution file reset

6.8.1 Program Reset

(1) Function

Resets all execution conditions (execution steps, variables) for a current file and allows execution of that program from the top.

This function is useful to execute a current file from the top of the program.

(2) Procedures

(a) Step 1: Command selection.

Press the NEXT key repeatedly until [RESET] is displayed in the menu, and press the corresponding function key.

MODE : T E A C H I N G / C O N T										T E S T P R O									
										L : 2 8									
										O : 2 0 %									
										M : F R E E									
										S : S T O P									
										C O N T									
M O D E			O V R D			R E S E T			D O			W A T C H			>				

Select [PROG].

MODE : T E A C H I N G / C O N T		T E S T P R O	
		L :	2 8
		O :	2 0 %
		M :	F R E E
		S :	S T O P
			C O N T
R E S E T : P R O G			
P R O G	C Y C L E	S T E P	S I G
S E L			

(b) Step 2: Run.

Make sure that your entry is correct, and press the EXE key. "STOP RESET" is shown under "S" (execution status) on the teach pendant display.

MODE : T E A C H I N G / C O N T		T E S T P R O	
		L :	2 8
		O :	2 0 %
		M :	F R E E
		S :	S T O P
			R E S E T
M O D E	O V R D	R E S E T	D O
W A T C H	>		

(3) Cautions

- All variables used in the program are reset.
- If you do not wish to the variables, use the step reset function instead.

6.8.2 Step Reset

(1) Function

Resets all execution conditions (excluding variables) for a current file and allows execution of that program from the top.

This function is useful to set the repetitive counts in a variable and execute the remaining counts.

(2) Procedures

(a) Step 1: Command selection.

Press the NEXT key repeatedly until [RESET] is displayed in the menu, and press the corresponding function key.

MODE : TEACHING / CONT		TEST PRO	
		L :	2 8
		O :	2 0 %
		M :	F R E E
		S :	S T O P
			C O N T
MODE	OVRD	RESET	DO
			WATCH >

Select [STEP].

MODE : TEACHING / CONT		TEST PRO	
		L :	2 8
		O :	2 0 %
		M :	F R E E
		S :	S T O P
			C O N T
RESET : STEP			
PROG	CYCLE	STEP	SIG
			SEL

(b) Step 2: Run.

Make sure that your entry is correct, and press the EXE key.

M O D E : T E A C H I N G / C O N T		T E S T P R O	
		L :	2 8
		O :	2 0 %
		M :	F R E E
		S :	S T O P
			C O N T
M O D E	O V R D	R E S E T	D O
			W A T C H
			>

(3) Caution

- When you do not wish to execute the setting of initial conditions at the head of the program, use the cycle reset instead.

6.8.3 Cycle Reset

(1) Function

Resets all execution conditions (excluding global variables) for a current file and allows execution of the main program from the step indicated by label RCYCLE. This function is useful when you do not wish to execute the setting of the initial condition.

(2) Procedures

(a) Step 1: Command selection.

Press the NEXT key repeatedly until [RESET] is displayed in the menu, and press the corresponding function key.

MODE : TEACHING / CONT		TEST PRO	
		L :	2 8
		O :	2 0 %
		M :	F R E E
		S :	S T O P
			C O N T
MODE	OVRD	RESET	DO
			WATCH >

Select [CYCLE].

MODE : TEACHING / CONT		TEST PRO	
		L :	2 8
		O :	2 0 %
		M :	F R E E
		S :	S T O P
			C O N T
RESET : CYCLE			
PROG	CYCLE	STEP	SIG
			SEL

(b) Step 2: Input through EXE key.

Make sure that your entry is correct, and press the EXE key. Unless label RCYCLE exists in the main program, the execution conditions, etc., remain unchanged.

M O D E : T E A C H I N G / C O N T		T E S T P R O	
		L :	2 8
		O :	2 0 %
		M :	F R E E
		S :	S T O P
			C O N T
M O D E	O V R D	R E S E T	D O
			W A T C H
			>

(3) Cautions

- Use label RCYCLE in a desired step of the main program.
- Also, specify the GOTO RCYCLE command just before the END command not to execute the END command of the main program.

6.8.4 Output Signal Reset

(1) Function

Sets off all user external output signals (DOUT (1) ~ DOUT (164)). The hand signals (201 ~ 204) will not turn off.

(2) Procedures

(a) Step 1: Command selection.

Press the NEXT key repeatedly until [RESET] is displayed in the menu, and press the corresponding function key.

MODE : TEACHING / CONT		TEST PRO	
		L :	2 8
		O :	2 0 %
		M :	F R E E
		S :	S T O P
			C O N T
MODE	OVRD	RESET	DO
			WATCH >

Select [SIG].

MODE : TEACHING / CONT		TEST PRO	
		L :	2 8
		O :	2 0 %
		M :	F R E E
		S :	S T O P
			C O N T
RESET : SIG			
PROG	CYCLE	STEP	SIG
			SEL

(b) Step 2: Command execution.

Make sure that your entry is correct, and press the EXE key.

The system sets off all user output signals and waits for entry of another command.

MODE : T E A C H I N G / C O N T		T E S T P R O			
		L :	2 8		
		O :	2 0 %		
		M :	F R E E		
		S :	S T O P		
			C O N T		
MODE	OVRD	RESET	DO	WATCH	>

6.8.5 Execution File Reset

(1) Function

Resets an execution file. This function is used to re-select an execution file and to terminate the test operation mode.

(2) Procedures

(a) Step 1: Command selection.

Press the NEXT key repeatedly until [RESET] is displayed in the menu, and press the corresponding function key.

MODE : TEACHING / CONT		TEST PRO	
		L :	2 8
		O :	2 0 %
		M :	F R E E
		S :	S T O P
			C O N T
MODE	OVRD	RESET	DO
			WATCH >

Select [SEL].

MODE : TEACHING / CONT		TEST PRO	
		L :	2 8
		O :	2 0 %
		M :	F R E E
		S :	S T O P
			C O N T
RESET : SEL			
PROG	CYCLE	STEP	SIG
			SEL >

(b) Step 2: Command execution.

Make sure that your entry is correct, and press the EXE key.

The execution file name is cleared and "STOP (RESET)" is indicated under "S" (execution status) on the display.

M O D E : T E A C H I N G / C O N T	
	L : O : 2 0 % M : F R E E S : S T O P R E S E T
E D I T	D E D I T
S E L	
	F I L E
	>

(3) Cautions

- All variables used in the program are reset.
- To start an operation, select the execution file again.

6.9 Direct Execution [DO]

(1) Function

Directly executes a SCOL command by entering it through the teach pendant. This function is used to establish the conditions leading to a specified step when you wish to execute a program from midway. The global variables in the program cannot be used, however.

(2) Procedures

(a) Step 1: Command selection.

Press the NEXT key repeatedly until [DO] is displayed in the menu, and press the corresponding function key.

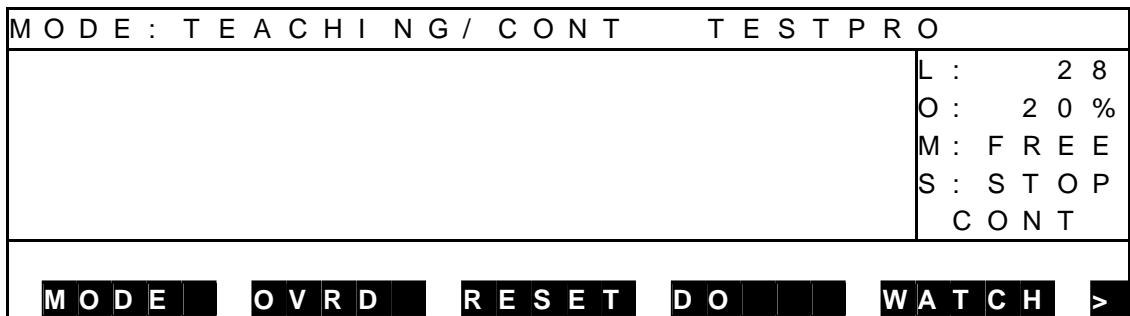

(b) Step 2: Input of SCOL command.

Enter the SCOL command you wish to execute through the keyboard. For details of the SCOL command, see the Robot Language Manual.

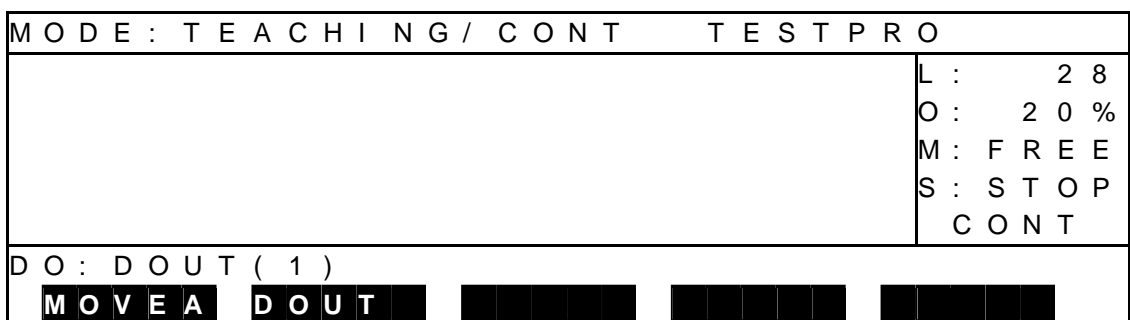

(c) Step 3: Command execution.

Make sure that your entry is correct, and press the EXE key.

During the execution, the menu as shown in Para. 6.6 is shown. When the operation has finished, the display changes as shown below.

MODE : T E A C H I N G / C O N T		T E S T P R O	
		L :	2 8
		O :	2 0 %
		M :	F R E E
		S :	S T O P
			C O N T
D O :			
M O V E A	D O U T		>

To execute the operation continuously, enter a command again and press the EXE key.

(d) Step 4: Finish.

To terminate the direct operation, press the ESC key.

MODE : T E A C H I N G / C O N T		T E S T P R O	
		L :	2 1 5
		O :	2 0 %
		M :	F R E E
		S :	S T O P
			C O N T
D O :			
M O D E	O V R D	R E S E T	D O
			W A T C H >

(3) Caution

This function is inoperative in the feed hold or servo power OFF status.

6.10 Variable Monitor

- (1) Function
Displays the values of a desired global variable.
- (2) Procedures
 - (a) Step 1: Command selection.
Press the NEXT key repeatedly until [WATCH] is displayed in the menu, and press the corresponding function key.
 - During stop

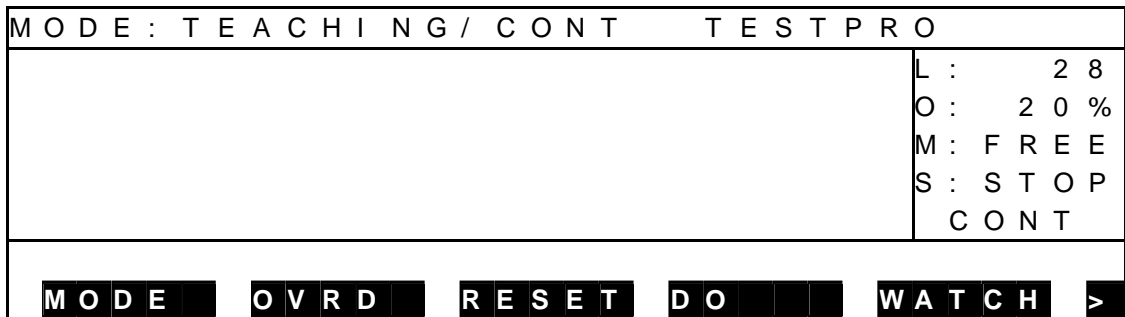

- During run

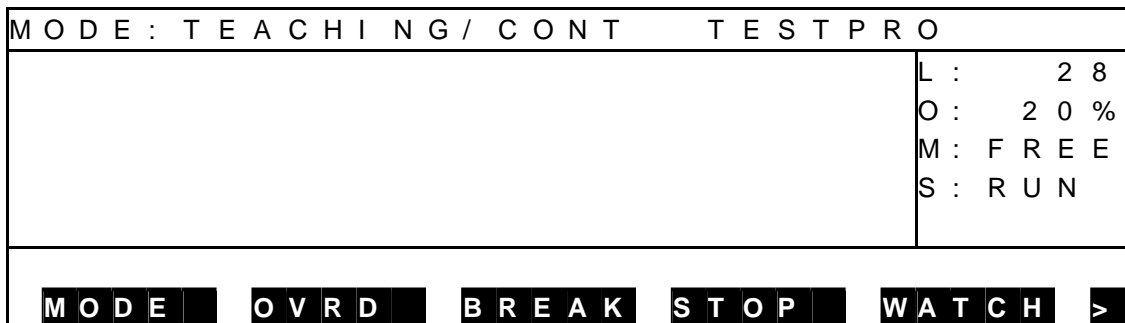

Press the [WATCH] function key, and the variable monitor display appears.

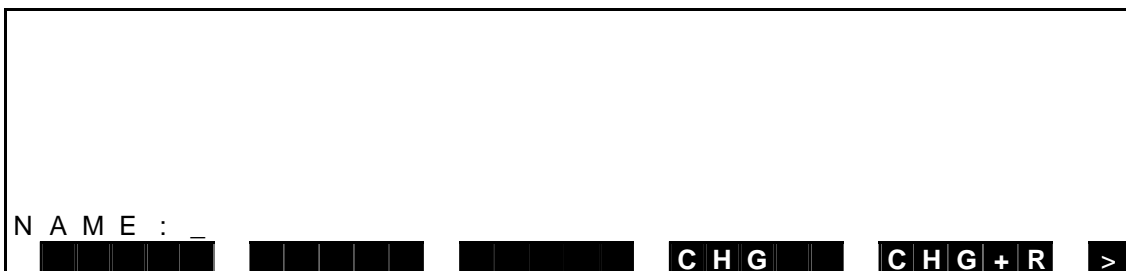

* The global variable signifies the variable (real number type, integer type, position type, coordinate type or load type) as defined in the area flanked by GLOBAL-END, or by DATA-END (for the variable which can be edited by the DEDIT function) in the program

(b) Step 2: Input of variable name.

Enter a variable name you wish to monitor, then press the EXE key. The variable name thus input and its values are displayed.

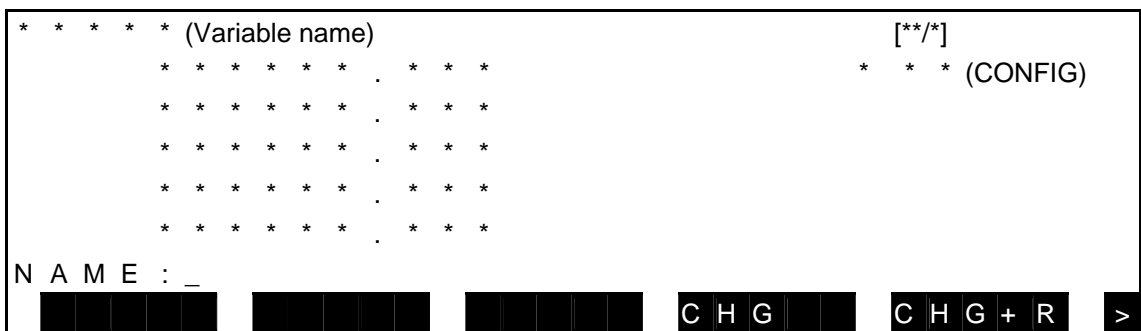

Unless the specified variable exists in the program, "-----.--" is displayed. Up to thirty (30) variable names can be registered.

(c) Step 3: Changeover of monitor variable display.

Monitor variable display can be changed over in the following manner.

Display of the next variable and after	Press the ↓ key.
Display of the previous variable and before	Press the ↑ key.
Display of already registered variable	Enter the already registered variable.

(d) Step 4: Change of variable value [CHG].

It is possible to change a programmed value temporarily. (To rewrite the initial value in the program, execute [CHG+R].)

[1] Press the [CHG] key, and the following display is called.

[2] A reversed indication can be shifted up or down by means of the ↑ or ↓ keys, respectively.

When the cursor is set to an element you wish to change, the relevant value of the selected element is displayed as [CHANGE : *****.***■]. Change the value and press the EXE key, then the value is updated.

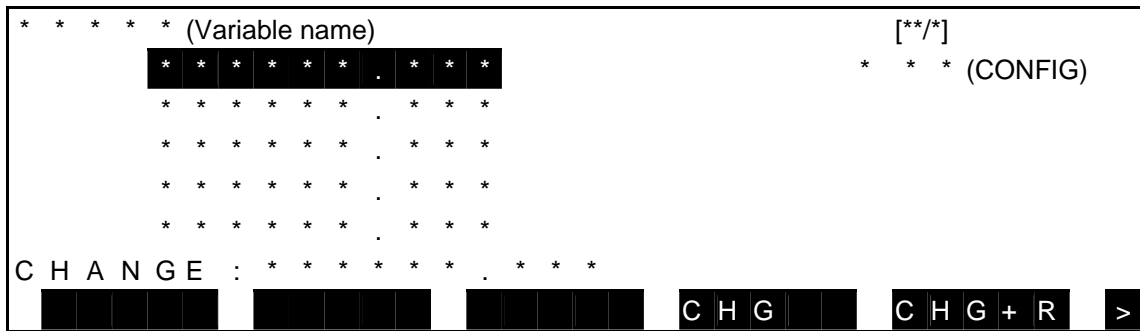

(e) Step 5: Change of variable [CHG+R].

It is possible to change the initial value in the program. By this operation, a statement itself in the program is rewritten.

[1] Press the [CHG+R] key, and the following display is called.

[2] A reversed indication can be shifted up or down by means of the ↑ or ↓ keys, respectively.

When the cursor is set to an element you wish to change, relevant value of the selected element is displayed as [CHANGE+RESTORE : *****.***■]. Change the value and press the EXE key, then the value is updated.

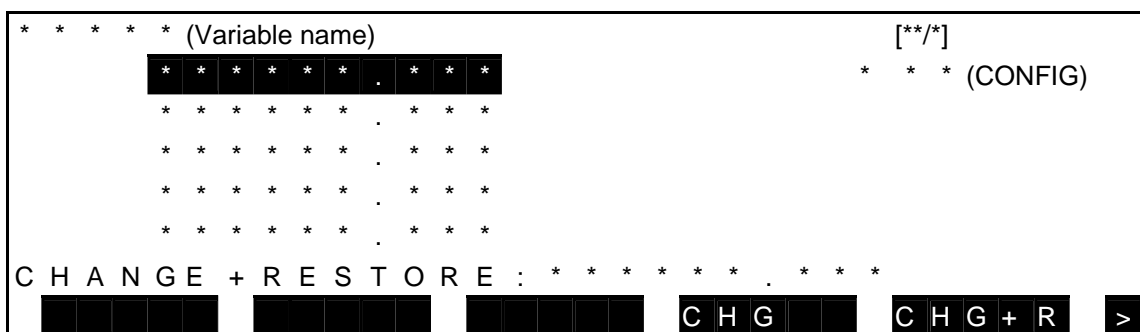

- (f) Step 6: Deletion of registered monitor variable.
Change over the monitor variable display until a variable you wish to delete is displayed. Then press the ALT and BS keys (DEL) at the same time.
- (g) Step 7: End of variable monitor.
Press the ESC key, and the system returns to the previous display of each mode.

**CAUTION**

- Unless any program is selected, displayed value may not be correct.
- The [CHG+R] function cannot be executed for the global variable yet to be initialized (such as position type array variable which is not taught the robot).
(If you are about to execute this, the error message saying "**Can not RESTORE**" is displayed.)
- The position type data can be changed in the range of **±3 mm or ±3 deg.**

6.11 Display of Line to be Executed

- (1) Function
Displays the execution program.
- (2) Operating procedure
 - (a) Step 1: Command selection.
Press the NEXT key to display [LDISP] in the menu, and then press the corresponding function key.

M O D E : T E A C H I N G / C O N T										T E S T P R O										
															L :	2 8				
															O :	2 0 %				
															M :	F R E E				
															S :	S T O P				
															C O N T					
L D I S P																				>

- (b) Step 2: Change of the monitor variable display.
Press the F1 key to change between the SCROLL screen and CURRENT screen.

- SCROLL screen (when program is stopped)

P R O G R A M										L I N E										D I S P L A Y										S C R O L L																			
0 0 0 1										:										P R O G R A M										T E S T																			
0 0 0 2										:										S P E E D =										5 0																			
0 0 0 3										:										M O V E										A																			
0 0 0 4										:										M O V E										B																			
0 0 0 5										:										M O V E										C																			
C U R R E										J U M P																				R U N																			

During program execution

C U R R E										J U M P										B R E A K										S T O P																			
-----------	--	--	--	--	--	--	--	--	--	---------	--	--	--	--	--	--	--	--	--	-----------	--	--	--	--	--	--	--	--	--	---------	--	--	--	--	--	--	--	--	--	--	--	--	--	--	--	--	--	--	--

The execution program can be viewed in this screen.

For details on the JUMP function, see "Description on Edit Commands" in Section 4.

- CURRENT screen (when program is stopped)

PROGRAM LINE DISPLAY										CURRENT									
0 0 0 1 : PROGRAM TEST																			
0 0 0 2 : SPEED = 5 0																			
0 0 0 3 : MOVE A																			
0 0 0 4 : MOVE B																			
0 0 0 5 : MOVE C																			
SCROLL					RUN														

During program execution

C	U	R	R	E	B	R	E	A	K	S	T	O	P
---	---	---	---	---	---	---	---	---	---	---	---	---	---

In this screen, the block that is currently being executed is highlighted for indicating which part of the program is being executed.

For details on the BREAK function and STOP function, see "Stop" in Para 6.7.

- (3) Caution
[LDISP] is not displayed in the STEP mode.

6.12 Finishing Test Operation

To finish test operation, execute the "execution file reset" function described in Para 6.8. However, as you can guide the robot even when the execution file has already been selected, you do not particularly need to reset the file.

You can also finish test operation in operation mode other than "TEACHING" by means of the MODE select switch on the control panel.

Section 7 Internal Automatic Operation

Internal automatic operation is the function only for TS3000. TSL3000 does not have the internal automatic operation function.



DANGER

NEVER enter the dangerous area of the robot during automatic operation. If you still have to enter the dangerous area, be sure to terminate the automatic operation and turn the servo power off beforehand. Also, select the teaching mode by means of the MODE select switch.



CAUTION

1. Make sure that no obstacle stands in the robot working range. If any obstacle exists, perform automatic operation at a slow speed and make sure that the robot will not collide with the obstacle at all.
2. If the robot motion becomes abnormal during program execution, press the EMERGENCY stop pushbutton switch immediately to stop the robot. **NEVER** restart the automatic operation until the cause of the abnormality is identified.
3. The speed of automatic operation is initially set at 100% of the maximum robot speed.

7.1 Selecting Internal Automatic Operation Mode (TS3000)

- (1) Function
Selects the internal automatic mode where you can execute a program by a start command given through the control panel.
- (2) Procedures
 - (a) Step 1: Selection of internal automatic mode.
Change over the MODE switch equipped on the control panel to "INTERNAL."

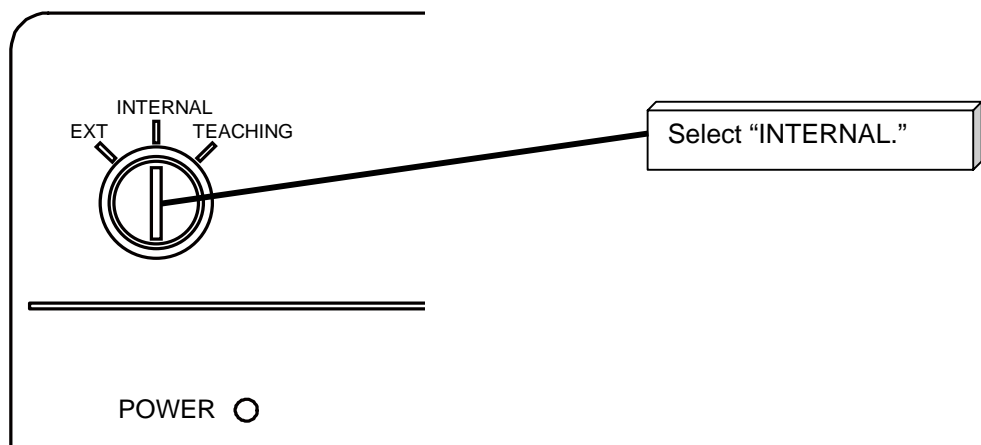

When the internal automatic mode is selected, the following screen appears.

M O D E : I N T E R N A L / C O N T									
								L :	
								O :	1 0 0 %
								M :	F R E E
								S :	S T O P
									R E S E T
S E L		M O D E		O V R D		R E S E T			>

Each time the NEXT key is pressed, the menu is selected as shown below.

W A T C H		L D I S P								>
-----------	--	-----------	--	--	--	--	--	--	--	---

Descriptions on display

- [1] MODE: Indicates the currently selected master mode and run mode.
- CONT : Continuous operation
 - CYCLE : Cycle operation
 - SEGMNT : Segment operation
- [2] Right side on the 1st line: Displays active file name.
- [3] L: No. of execution steps
- [4] O: Speed override
- [5] M: Machine status
- FREE : Machine lock OFF status
- [6] S: Execution status
- RUN : A program is currently executed.
 - STOP RESET : A program is stopped in the initialize mode.
This is the same as the program reset.
 - STOP RETRY : A program is stopped in the restart mode.
It is restarted from the interrupted motion.
 - STOP CONT : A program is stopped in the continue mode.
It is restarted from the current program step.
- [7] Bottom line: Function key menu display field
- [SEL] : Selection of program to be executed
 - [MODE] : Run mode selection
 - [OVRD] : Override setting
 - [RESET] : Reset
 - [DO] : Direct execution
 - [WATCH] : Variable monitor
 - [STOP] : Stop
 - [BREAK] : Interruption
 - [LDISP] : Display of line to be executed

7.2 Selecting File [SEL]

- (1) Function
Selects a file (or program) to be executed.
- (2) Procedures
 - (a) Step 1: Command selection.
Press the function key corresponding to the [SEL] menu. Unless the [SEL] menu is available, press the NEXT key repeatedly until [SEL] is displayed in the menu.

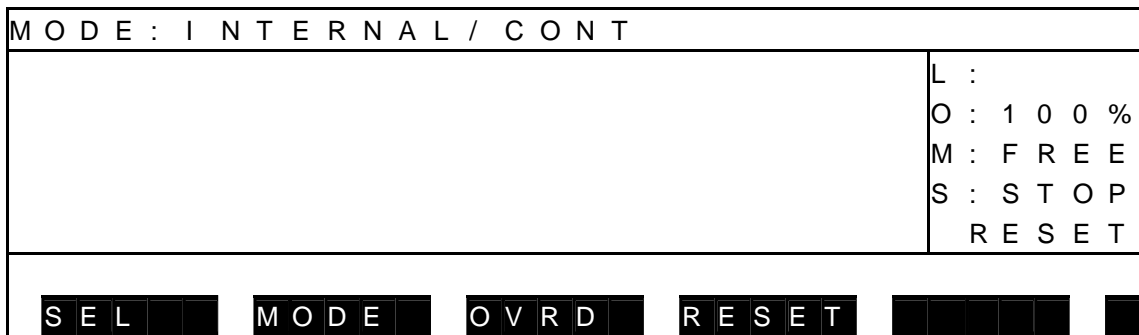

- (b) Step 2: Input of file name.
When the file directory is displayed, inversely display and select a desired file name, using the up and down cursor keys, then press the EXE key.
[NAME] and [TIME] in the menu are used to sort the file directory by name and time, respectively. To directly enter the file name through the keyboard, press the [INPUT] function key and input the file name you wish to execute. If the file name contains an extension, be sure to input the extension also.

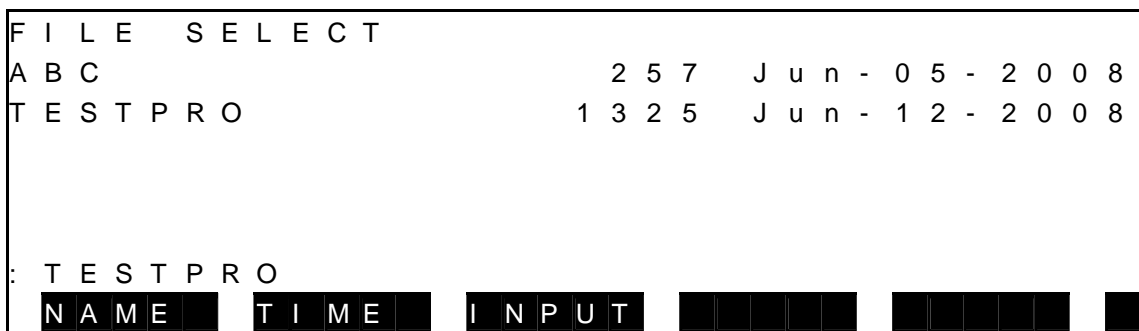

(c) Step 3: Input of EXE key.

Make sure that your entry is correct, and press the EXE key. Then the specified file name is displayed in the execution file display field on the 1st line.

M O D E : I N T E R N A L / C O N T										T E S T P R O									
															L :				
															O : 1 0 0 %				
															M : F R E E				
															S : S T O P				
															R E S E T				
S E L			M O D E			O V R D			R E S E T						>				

(3) Cautions

- Once the execution file has been selected, it remains effective until another file is selected. If a compile error has occurred, however, selection of the execution file is canceled.
- When another file has been selected, the execution environment of automatic operation is reset. To reset the execution environment without changing the execution file, execute [RESET] and [PROG].

7.3 Selecting Run Mode [MODE]

- (1) Function
Changes over the run mode of automatic operation.
- (2) Procedures
 - (a) Step 1: Command selection.
Press the NEXT key repeatedly until [MODE] is displayed in the menu.
Press the corresponding function key then.

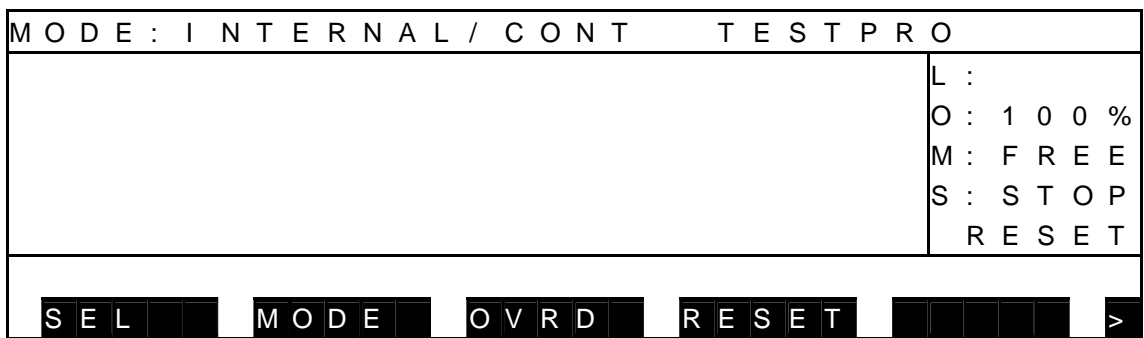

- (b) Step 2: Mode selection.
Select a desired run mode from the menu.

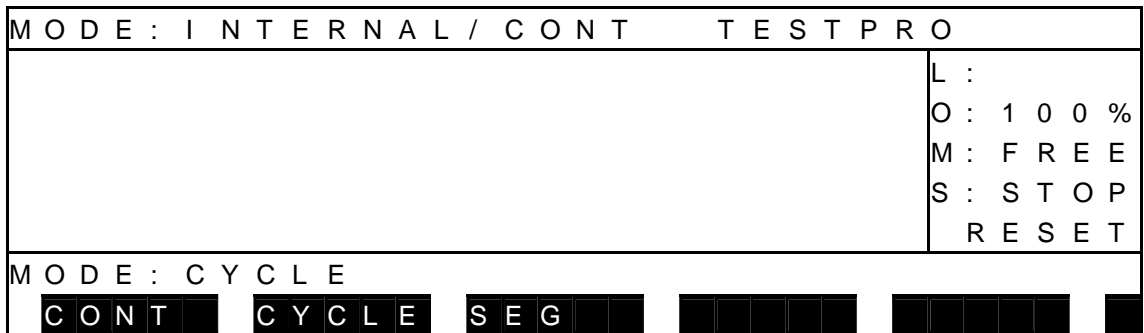

- [CONT] : Repeats program execution continuously.
- [CYCLE] : Stops program execution at the end of the program.
- [SEG] : Stops program execution just before the next motion command.

(c) Step 3: Input of EXE key.

Make sure that your entry is correct, and press the EXE key. If you have entered wrong data, press the ESC key to cancel the entry and select again. Then the specified run mode is shown on the display.

M O D E : I N T E R N A L / C O N T										T E S T P R O									
										L :									
										O : 1 0 0 %									
										M : F R E E									
										S : S T O P									
										R E S E T									
S E L		M O D E		O V R D		R E S E T												>	

(3) Cautions

- The run mode can be selected even while the program is being executed.
- The execution mode selected is also operative in both the test operation mode and external automatic mode.
- The selected run mode remains valid until another run mode is selected.
- If the stop command is executed in the program, program execution stops, irrespective of the run mode currently selected.

7.4 Speed Override [OVRD]

(1) Function

Sets the speed override for automatic operation. This function is useful to effect an additional override, taking the programmed speed as 100%.

(2) Procedures

(a) Step 1: Command selection.

Press the NEXT key repeatedly until [OVRD] is displayed in the menu.
Press the corresponding function key then.

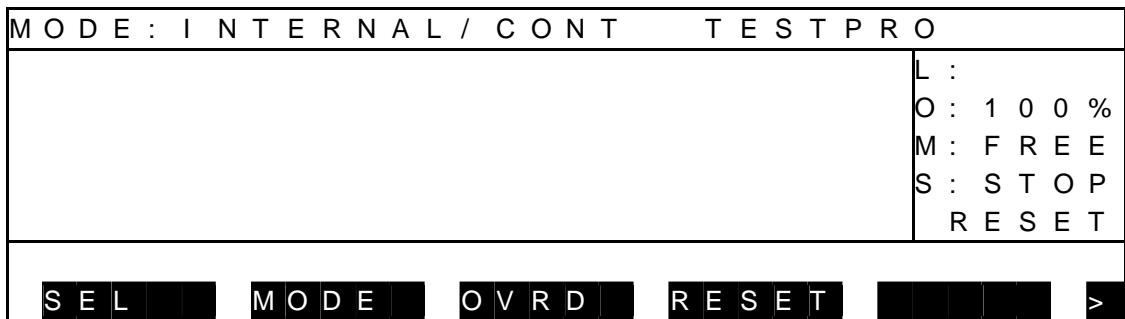

(b) Step 2: Input of speed override.

Set an override of 1 ~ 100 on the speed by means of the appropriate function key.

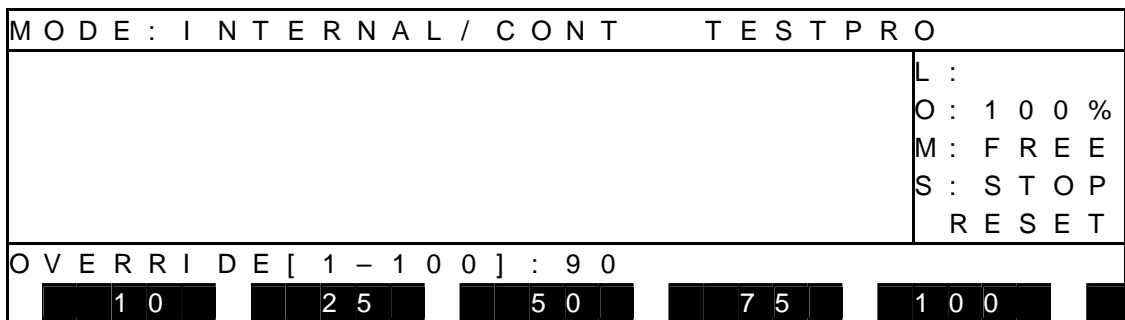

(c) Step 3: Input through EXE key.

Make sure that your entry is correct, and press the EXE key. Then the specified override value is shown under "O:" on the display.

M O D E : I N T E R N A L / C O N T										T E S T P R O									
										L :									
										O : 9 0 %									
										M : F R E E									
										S : S T O P									
										R E S E T									
S E L		M O D E		O V R D		R E S E T												>	

If zero (0) is specified for the speed override, a relevant message is displayed and the entry becomes invalid.

(3) Caution

- The specified speed override is also operative in both the test operation mode and external automatic mode. The selected override remains valid until another override is specified.

7.5 Startup

(1) Function

Starts an automatic operation under the predetermined conditions.

(2) Procedures

(a) Step 1: Setting of running conditions.

Set the conditions for executing the file selection, run mode selection, and speed override setting as necessary.

(b) Step 2: Turning On the Startup Switch.

Press the RUN switch on the controller front panel.

When program execution has started, the STOP LED goes out with the RUN LED illuminated.

"RUN" is selected for "S" (execution status) on the teach pendant display.

M O D E : I N T E R N A L / C O N T		T E S T P R O	
		L :	7
		O :	1 0 0 %
		M :	F R E E
		S :	R U N
M O D E	O V R D	B R E A K	S T O P
		W A T C H	

(3) Cautions

- The "startup command" external control signal is inoperative in the internal automatic operation mode.
- Also, the run function cannot be executed through the teach pendant.

7.6 Stop

7.6.1 Cycle Stop

(1) Function

Selects "CYCLE" for the run mode and stops an automatic operation at the program end. This function is used to stop the robot after the end of an operation.

(2) Procedures

(a) Step 1: Input of cycle stop.

Display the [MODE], then press the corresponding function key. The run mode on the teach pendant display is changed to "CYCLE". When the program has been executed to the end, the automatic operation stops at the same time that the RUN LED on the controller front panel goes out with the STOP LED illuminated.

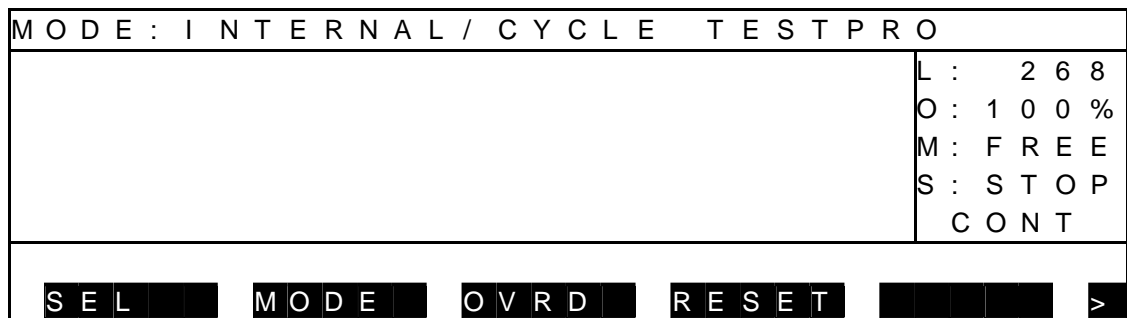

(b) Step 2: Cancel of cycle stop.

The run mode on the display returns to the previous run mode. To resume the operation, press the RUN switch.

(3) Cautions

- The "cycle stop" external control signal is inoperative in the internal automatic operation mode.
- When the cycle stop is commanded again, the system returns to the previous run mode.
- The SCOL program execution unit pre-reads up to four (4) motion commands. Therefore, the program may be executed successively by up to three (3) cycles according to the cycle stop timing or the active program contents.

7.6.2 STOP

(1) Function

Stops an automatic operation when the active command has been executed. This function is used for normal stop operation.

(2) Procedures

(a) Step 1: Input of STOP.

- Control panel: Press the STOP switch.
- Teach pendant: Press the function key corresponding to the [STOP] menu.

The STOP LED on the control panel is illuminated. When the currently executed command has completed, the automatic operation stops at the same time that the RUN LED on the control panel turns off with "STOP (CONT)" shown under "S" (execution status) on the teach pendant display.

M O D E : I N T E R N A L / C O N T										T E S T P R O					
										L : 2 6 8					
										O : 1 0 0 %					
										M : F R E E					
										S : S T O P					
										C O N T					
S E L			M O D E			O V R D			R E S E T						>

(3) Cautions

- In the internal automatic operation mode, the "stop" external control signal is inoperative.
- To restart the operation, press the RUN key.

7.6.3 BREAK

(1) Function

Immediately decelerates and stops the robot, and stops an automatic operation. This function is used to interrupt the automatic operation.

(2) Procedures

(a) Step 1: Input of BREAK.

Press the function key corresponding to the [BREAK] menu. The robot immediately slows down and stops to stop the automatic operation.

The RUN LED on the control panel turns off with the STOP LED illuminated. "STOP (RETRY)" is shown under "S" (execution status) on the teach pendant display.

M O D E : I N T E R N A L / C O N T										T E S T P R O									
										L : 2 6 8									
										O : 1 0 0 %									
										M : F R E E									
										S : S T O P									
										R E T R Y									
S E L		M O D E		O V R D		R E S E T												>	

To restart the operation, press the RUN key.

7.6.4 FEED HOLD

(1) Function

Holds robot motion and program execution. When this function is specified during robot operation, the robot immediately slows down and stops. The feed hold function is used to stop the robot temporarily.

(2) Procedures

(a) Step 1: Input of FEED HOLD.

Press the FEED HOLD pushbutton switch equipped on the teach pendant, and the FEED HOLD switch LED is illuminated. If the robot is working, it decelerates and stops.

When the robot has stopped, the RUN LED on the controller front panel goes out with the STOP LED illuminated. The display of the teach pendant is as shown below with "STOP (RETRY)" indicated under "S" (execution status).

M O D E : I N T E R N A L / C O N T										T E S T P R O									
										L : 6 8									
										O : 1 0 0 %									
										M : F R E E									
										S : S T O P									
										R E T R Y									
S E L		M O D E		O V R D		R E S E T												>	

(b) Step 2: Cancel of feed hold.

While the FEED HOLD switch LED is turned on, press the FEED HOLD switch again. The FEED HOLD switch LED turns off and the automatic operation restarts.

If feed hold was commanded during program execution, program execution can be restarted by canceling the feed hold.

When the program has restarted, the STOP LED on the control panel turns off with the RUN LED illuminated.

"RUN" is shown under "S" (execution status) on the teach pendant display.

M O D E : I N T E R N A L / C O N T		T E S T P R O	
		L :	8 7
		O :	1 0 0 %
		M :	F R E E
		S :	R U N
M O D E	O V R D	B R E A K	S T O P
			W A T C H

(3) Cautions

- In the feed hold mode, automatic operation, step execution and direct execution are invalid.
- When the FEED HOLD switch is pressed again, feed hold is canceled. If the feed hold was commanded during program execution, program execution can be restarted by canceling the feed hold.
- When master mode transition, file selection, and execution condition reset are carried out, the servo power turns off and the feed hold is released. The program will not be restarted during the feed hold.

7.6.5 EMERGENCY Stop

(1) Function

Turns off the servo power and stops an automatic operation. This function is useful to stop the robot system at the time of an emergency.

(2) Procedures

Press the EMERGENCY stop pushbutton switch equipped on the control panel or teach pendant, or use the "emergency stop" external control signal.

The servo power is turned off and the SERVO ON switch LED on the control panel goes out with the SERVO OFF switch LED illuminated.

The servo ON switch LED on the teach pendant goes out.

(3) Cautions

- All of the EMERGENCY stop switches on the control panel and teach pendant, and "emergency stop" external control signal are operative. At the time of an emergency, use whichever key you can get at quickest.
- The EMERGENCY stop switches on the control panel and teach pendant are of a lock type.
- When pressed, they remain depressed and locked. To reset, turn and unlock the switch.
- While the EMERGENCY stop switch is ON, the servo power cannot be turned on.

7.7 Reset [RESET]

The reset operation comes in the following five (5) modes. Any mode other than (4) cannot be reset unless a file for execution is selected.

- (1) Program reset
- (2) Step reset
- (3) Cycle reset
- (4) Output signal reset
- (5) Execution file reset

7.7.1 Program Reset

- (1) Function

Resets all execution conditions (execution steps, variables) for a current file and allows execution of that program from the top.

This function is useful to execute a current file from the top of the program.

- (2) Procedures

- (a) Step 1: Command selection.

Press the NEXT key repeatedly until [RESET] is displayed in the menu, and press the corresponding function key.

MODE : INTERNAL / CONT										TESTPRO									
										L : 28									
										O : 100%									
										M : FREE									
										S : STOP									
										CONT									
SEL		MODE		OVRD		RESET												>	

Select [PROG].

MODE : INTERNAL / CONT										TESTPRO													
										L : 28													
										O : 100%													
										M : FREE													
										S : STOP													
										CONT													
RESET : PROG																							
PROG				CYCLE				STEP				SIG				SEL							

(b) Step 2: Input through EXE key.

Make sure that your entry is correct, and press the EXE key. "STOP (RESET)" is shown under "S" (execution status) on the teach pendant display.

M O D E : I N T E R N A L / C O N T										T E S T P R O									
															L :				
															O : 1 0 0 %				
															M : F R E E				
															S : S T O P				
															R E S E T				
S E L			M O D E			O V R D			R E S E T						>				

(3) Cautions

- All variables used in the program are reset.
- If you do not wish to the variables, use the step reset function instead.

7.7.2 Step Reset

(1) Function

Resets all execution conditions (excluding global variables) for a current file and allows execution of that program from the top.

(2) Procedures

(a) Step 1: Command selection.

Press the NEXT key repeatedly until [RESET] is displayed in the menu, and press the corresponding function key.

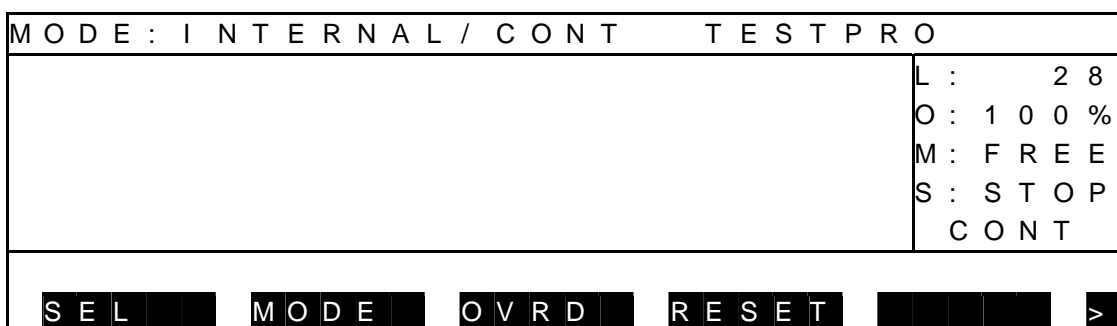

Select [STEP] by pressing the corresponding function key.

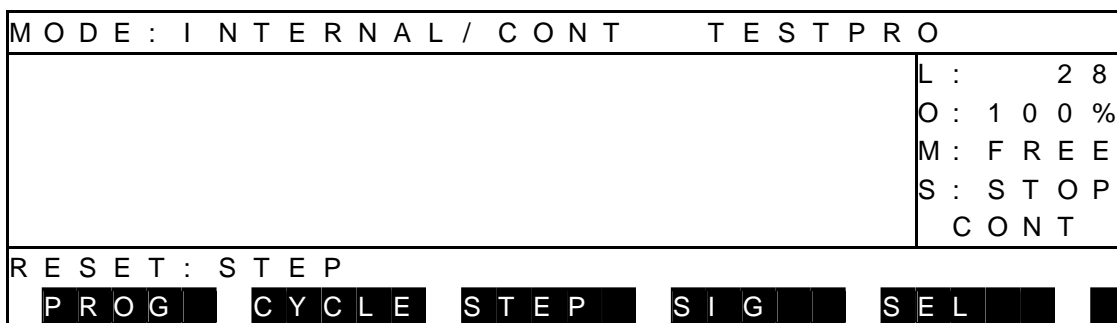

(b) Step 2: Input of EXE key.

Make sure that your entry is correct, and press the EXE key.

M O D E : I N T E R N A L / C O N T										T E S T P R O									
										L : 2 8									
										O : 1 0 0 %									
										M : F R E E									
										S : S T O P									
										C O N T									
S E L				M O D E				O V R D				R E S E T						>	

(3) Caution

When you do not wish to execute the setting of initial conditions at the head of the program, use the cycle reset instead.

7.7.3 Cycle Reset

(1) Function

Resets all execution conditions (excluding global variables) for a current file and allows execution of the main program from the step indicated by label RCYCLE. This function is useful when you do not wish to execute the setting of the initial condition.

(2) Procedures

(a) Step 1: Command selection.

Press the NEXT key repeatedly until [RESET] is displayed in the menu, and press the corresponding function key.

MODE : I N T E R N A L / C O N T										T E S T P R O									
															L : 2 8				
															O : 1 0 0 %				
															M : F R E E				
															S : S T O P				
															C O N T				
SEL		MODE			OVRD			RESET						>					

Select [CYCLE].

MODE : I N T E R N A L / C O N T										T E S T P R O									
															L : 2 8				
															O : 1 0 0 %				
															M : F R E E				
															S : S T O P				
															C O N T				
R E S E T : C Y C L E																			
PROG			CYCLE			STEP			SIG			SEL							

(b) Step 2: Input through EXE key.

Make sure that your entry is correct, and press the EXE key.

M O D E : I N T E R N A L / C O N T										T E S T P R O										
															L :	2 8				
															O :	1 0 0 %				
															M :	F R E E				
															S :	S T O P				
															C O N T					
S E L		M O D E		O V R D		R E S E T										>				

(3) Caution

Use label RCYCLE in a desired step of the main program. Also, specify the GOTO RCYCLE command just before the END command not to execute the END command of the main program.

7.7.4 Output Signal Reset

(1) Function

Sets off all user external output signals (DOUT (1) ~ DOUT (164)). The hand signals (201 ~ 204) will not turn off.

(2) Procedures

(a) Step 1: Command selection.

Press the NEXT key repeatedly until [RESET] is displayed in the menu, and press the corresponding function key.

M O D E : I N T E R N A L / C O N T										T E S T P R O									
															L : 2 8				
															O : 1 0 0 %				
															M : F R E E				
															S : S T O P				
															C O N T				
S E L		M O D E			O V R D			R E S E T						>					

Select [SIG].

M O D E : I N T E R N A L / C O N T										T E S T P R O									
															L : 2 8				
															O : 1 0 0 %				
															M : F R E E				
															S : S T O P				
															C O N T				
R E S E T : S I G																			
P R O G		C Y C L E			S T E P			S I G			S E L								

(b) Step 2: Input through EXE key.

Make sure that your entry is correct, and press the EXE key.

M O D E : I N T E R N A L / C O N T										T E S T P R O									
															L : 2 8				
															O : 1 0 0 %				
															M : F R E E				
															S : S T O P				
															C O N T				
S E L		M O D E			O V R D			R E S E T						>					

7.7.5 Execution File Reset

(1) Function

Resets an execution file. This function is used to re-select an execution file.

(2) Procedures

(a) Step 1: Command selection.

Press the NEXT key repeatedly until [RESET] is displayed in the menu.

MODE : I N T E R N A L / C O N T										T E S T P R O									
															L : 2 8				
															O : 1 0 0 %				
															M : F R E E				
															S : S T O P				
															C O N T				
SEL		MODE		OVRD		RESET										>			

Select [SEL] by pressing the corresponding function key.

MODE : I N T E R N A L / C O N T										T E S T P R O									
															L : 2 8				
															O : 1 0 0 %				
															M : F R E E				
															S : S T O P				
															C O N T				
R E S E T : S E L																			
PROG		CYCLE		STEP		SIG		SEL											

(b) Step 2: Input through EXE key.

Make sure that your entry is correct, and press the EXE key.

The execution file name is cleared and "STOP (RESET)" is indicated under "S" (execution status) on the display.

M O D E : T E A C H I N G / C O N T	
	L : O : 1 0 0 % M : F R E E S : S T O P R E S E T
S E L	M O D E O V R D R E S E T

(3) Cautions

- All variables used in the program are reset.
- To start an operation, select the execution file again.

7.8 Direct Execution [DO]

(1) Function

Entering a SCOL command from the teach pendant enables direct execution of that command. This is used to meet the various conditions until reaching the step for executing from the middle of a program.

However, program global variables cannot be used.

(2) Procedures

(a) Step 1: Selection of command

Press the NEXT key to display [DO] on the menu, and then press the corresponding function key.

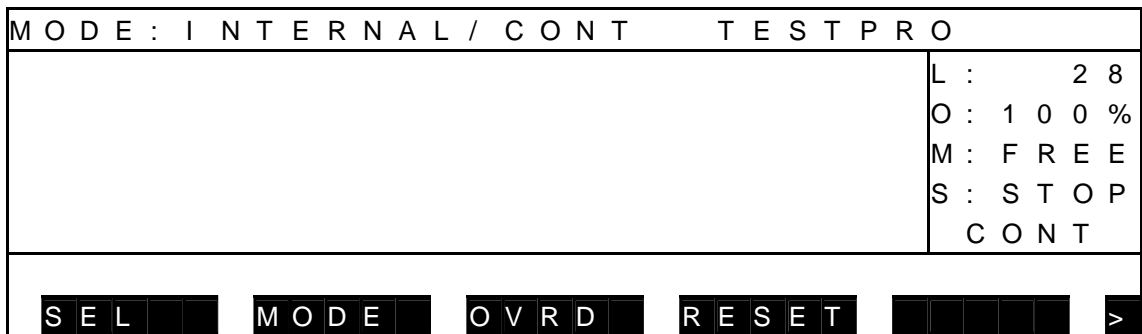

(b) Step 2: SCOL command input

Enter the SCOL command to be executed from the keyboard.

For details on the SCOL command, see the Robot Language Manual.

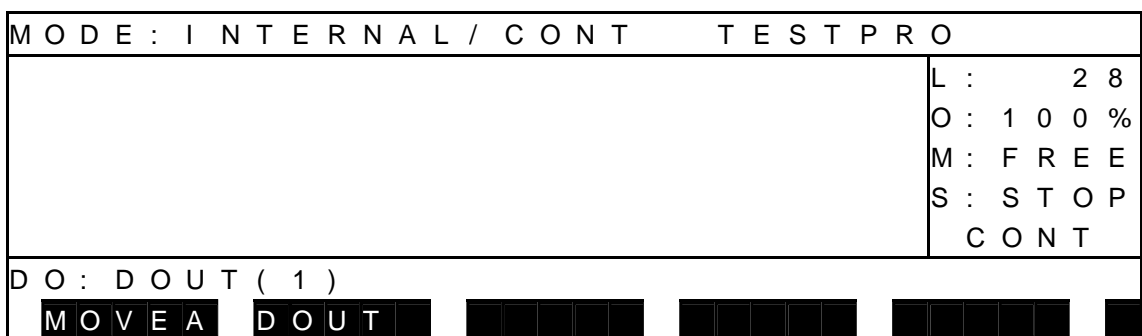

(c) Step 3: Execution key input

Check that the entry is correct, and press the EXE key.

During execution, the menu shown in Para. 7.5 is displayed. When operation is finished, the screen appears as shown below.

MODE : INTERNAL / CONT		TEST PRO	
		L :	2 8
		O :	1 0 0 %
		M :	FREE
		S :	STOP
			CONT
DO :			
MOVE A	DO UT		

To execute another command, enter the command again, and press the EXE key.

(d) Step 4: Exit

To exit direct execution, press the ESC key.

MODE : INTERNAL / CONT		TEST PRO	
		L :	2 8
		O :	1 0 0 %
		M :	FREE
		S :	STOP
			CONT
SEL	MODE	OVRD	RESET
			>

(3) Caution

The direction execution function is disabled in the feed hold and servo power OFF states.

7.9 Variable Monitor

- (1) Function
 - Displays the values of a desired global variable.
 - (2) Procedures
 - (a) Step 1: Command selection.
 - Press the NEXT key repeatedly until [WATCH] is displayed in the menu, and press the corresponding function key.
- During stop

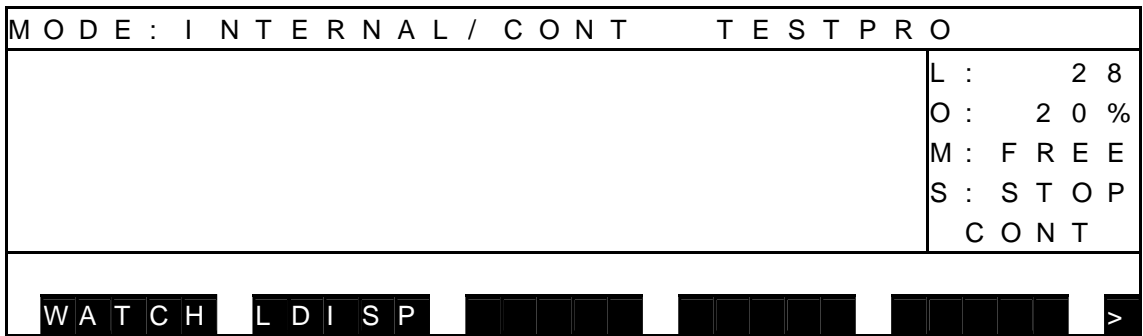

- During run

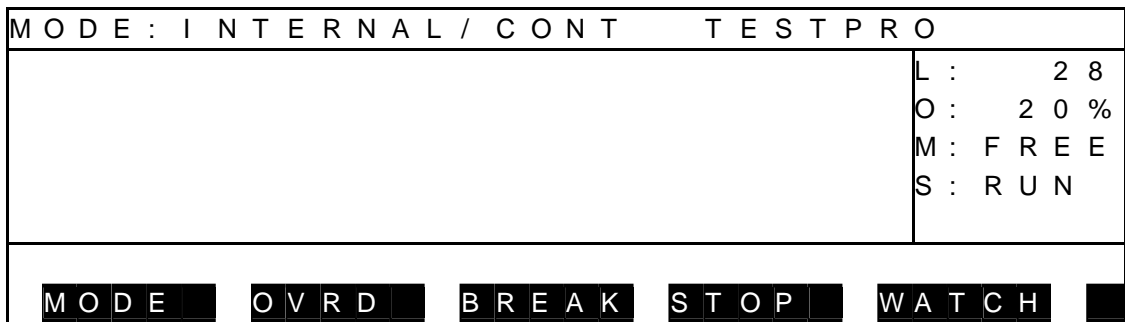

Press the [WATCH] function key, and the variable monitor display appears.

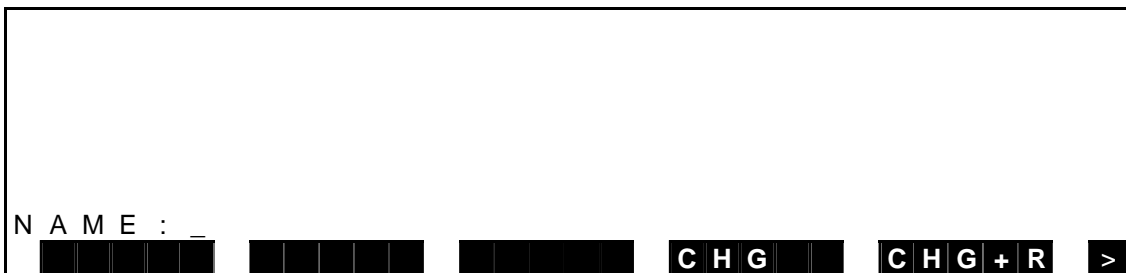

- * The global variable signifies the variable (real number type, integer type, position type, coordinate type or load type) as defined in the area flanked by GLOBAL-END, or by DATA-END (for the variable which can be edited by the DEDIT function) in the program.

(b) Step 2: Input of variable name.

Enter a variable name you wish to monitor, then press the EXE key. The variable name thus input and its values are displayed.

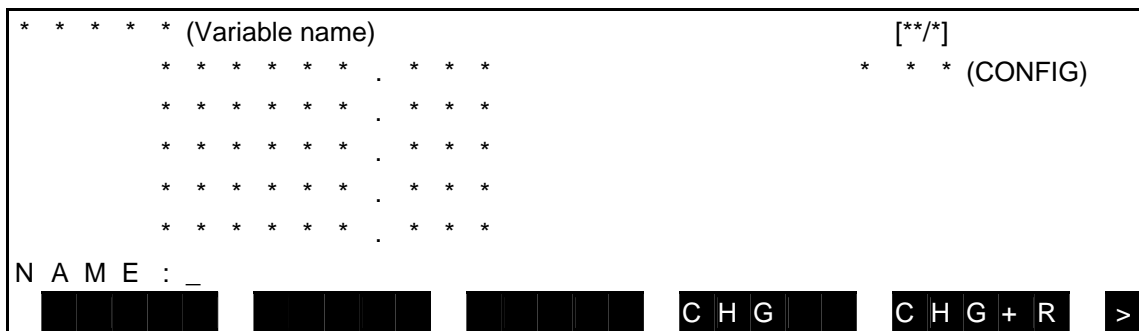

Unless the specified variable exists in the program, "-----,---" is displayed. Up to thirty (30) variable names can be registered.

(c) Step 3: Changeover of monitor variable display.

Monitor variable display can be changed over in the following manner.

Display of the next variable and after	Press the ↓ key.
Display of the previous variable and before	Press the ↑ key.
Display of an already registered variable	Enter the already registered variable.

(d) Step 4: Change of variable value [CHG].

It is possible to change a programmed value temporarily. (To rewrite the initial value in the program, execute [CHG+R].)

[1] Press the [CHG] key, and the following display is called.

[2] A reversed indication can be shifted up or down by means of the ↑ or ↓ key, respectively.

When the cursor is set to an element you wish to change, the relevant value of the selected element is displayed as [CHANGE : *****.***■]. Change the value and press the EXE key, then the value is updated.

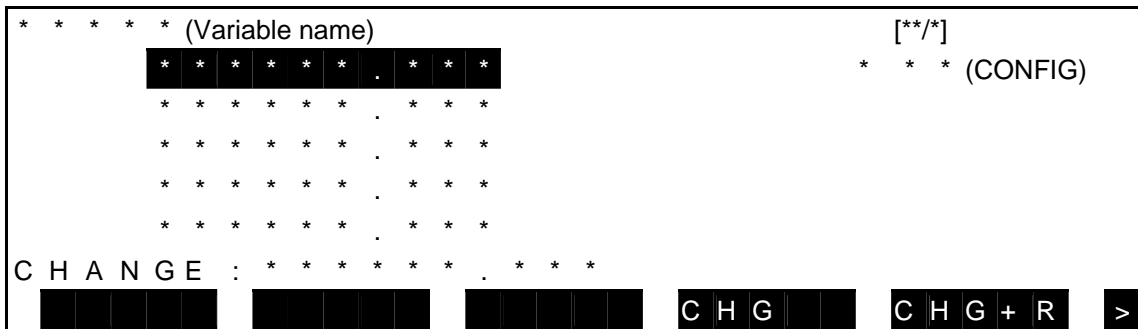

(e) Step 5: Change of variable [CHG+R].

It is possible to change the initial value in the program. By this operation, a statement itself in the program is rewritten.

[1] Press the [CHG+R] key, and the following display is called.

[2] A reversed indication can be shifted up or down by means of the ↑ or ↓ key, respectively.

When the cursor is set to an element you wish to change, the relevant value of the selected element is displayed as [CHANGE+RESTORE : *****.***■]. Change the value and press the EXE key, then the value is updated.

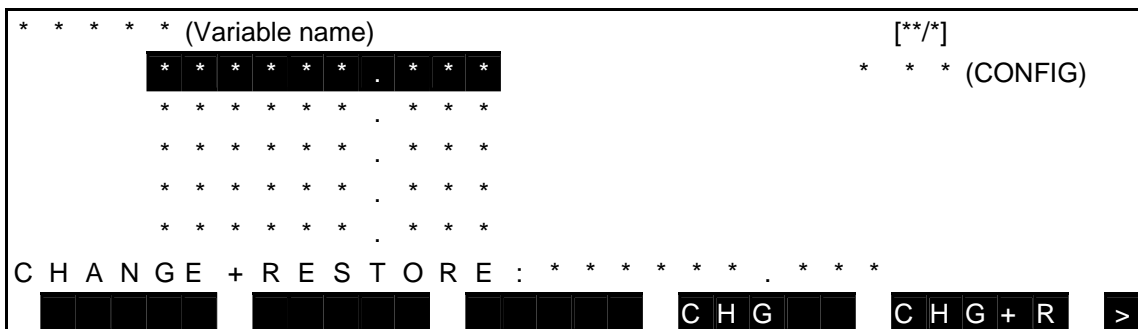

(f) Step 6: Deletion of registered monitor variable.

Change over the monitor variable display until a variable you wish to delete is displayed. Then press the ALT and BS keys (DEL) at the same time.

(g) Step 7: End of variable monitor.

Press the ESC key, and the system returns to the previous display of each mode.

**CAUTION**

- Unless any program is selected, displayed value may not be correct.
- The [CHG+R] function cannot be executed for the global variable yet to be initialized (such as position type array variable which is not taught the robot).
(If you are about to execute this, the error message saying "**Can not RESTORE**" is displayed.)
- The position type data can be changed in the range of **±3 mm or ±3 deg.**

7.10 Display of Line to be Executed

- (1) Function
Displays the execution program.
- (2) Operating procedure
 - (a) Step 1: Command selection.
Press the NEXT key to display [LDISP] in the menu, and then press the corresponding function key.

M O D E : T E A C H I N G / C O N T T E S T P R O									
								L :	2 8
								O :	2 0 %
								M :	F R E E
								S :	S T O P
								C O N T	
W A T C H		L D I S P							

- (b) Step 2: Change the monitor variable display.
Press the F1 key to change between the SCROLL screen and CURRENT screen.
- SCROLL screen (when program is stopped)

P R O G R A M	L I N E	D I S P L A Y	S C R O L L						
0 0 0 1	:	P R O G R A M	T E S T						
0 0 0 2	:	S P E E D =	5 0						
0 0 0 3	:	M O V E	A						
0 0 0 4	:	M O V E	B						
0 0 0 5	:	M O V E	C						
C U R R E		J U M P				R U N			

During program execution

C U R R E	J U M P	B R E A K	S T O P						
-----------	---------	-----------	---------	--	--	--	--	--	--

The execution program can be viewed in this screen.
For details on the JUMP function, see "Description on Edit Commands" in Section 4.

- CURRENT screen (when program is stopped)

P	R	O	G	R	A	M	L	I	N	E	D	I	S	P	L	A	Y	C	U	R	R	E	N	T	
0	0	0	1	:	P	R	O	G	R	A	M	T	E	S	T										
0	0	0	2	:	S	P	E	E	D	=	5	0													
0	0	0	3	:	M	O	V	E	A																
0	0	0	4	:	M	O	V	E	B																
0	0	0	5	:	M	O	V	E	C																
S	C	R	L	L						R	U	N													

During program execution

S	C	R	L	L						B	R	E	A	K	S	T	O	P						
---	---	---	---	---	--	--	--	--	--	---	---	---	---	---	---	---	---	---	--	--	--	--	--	--

In this screen, the block that is currently being executed is highlighted for indicating which part of the program is being executed.

For details on the BREAK function and STOP function, see "Stop" in Para 7.6.

- (3) Caution
[LDISP] is not displayed in the STEP mode.

Section 8 External Automatic Operation**DANGER**

NEVER enter the dangerous area of the robot during automatic operation. If you still have to enter the dangerous area, be sure to terminate the automatic operation and turn the servo power off beforehand. Also, select the teaching mode by means of the MODE select switch.

**CAUTION**

1. Make sure that no obstacle stands in the robot working range. If any obstacle exists, perform automatic operation at a slow speed and make sure that the robot will not collide with the obstacle at all.
2. If the robot motion becomes abnormal during program execution, press the EMERGENCY stop pushbutton switch immediately to stop the robot. NEVER restart the automatic operation until the cause of the abnormality is identified.
3. The speed of automatic operation is initially set at 100% of the maximum robot speed.

8.1 Selecting External Automatic Operation Mode

(1) Function

Selects the external automatic mode where you can execute a program by external control signals or commands given from the host computer.

(2) Procedures

(a) Step 1: Selection of external automatic mode.

- External signal mode

Press the MODE switch equipped on the control panel to select "EXT".

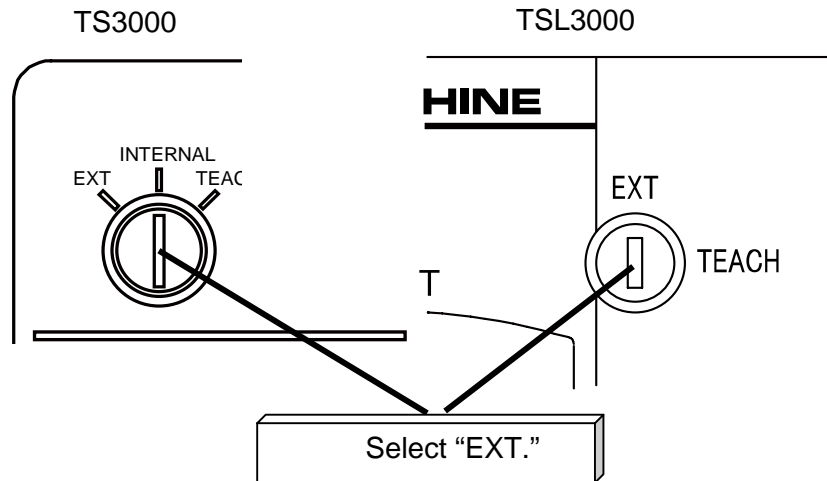

When the external automatic mode is selected, the following screen appears.

- EX. SIG

MODE : EX . SIG / CONT	
	L : O : 1 0 0 % M : FREE S : STOP RESET
L D I S P	W A T C H

- EX. 232C

MODE : EX . 2 3 2 C / C O N T				
				L :
				O : 1 0 0 %
				M : F R E E
				S : S T O P
				R E S E T
L D I S P				W A T C H

- EX. ETHER (Standard for TS3000/Option for TSL3000)

MODE : EX . E H T E R / C O N T				
				L :
				O : 1 0 0 %
				M : F R E E
				S : S T O P
				R E S E T
L D I S P				W A T C H

Descriptions on display

[1] MODE: Indicates the currently selected master mode and run mode.

EXT. SIG : External control signal mode

EX. 232C : Host mode (Control by host computer)

EX. ETHER : Host mode (Control by host computer)

CONT : Continuous operation

CYCLE : Cycle operation

[2] Right side on the 1st line: Displays active file name.

[3] L: No. of execution steps

[4] O: Speed override

[5] M: Machine status

FREE : Machine lock OFF status

[6] S: Execution status

RUN : A program is currently executed.

STOP RESET : A program is stopped in the initialize mode.
This is the same as the program reset.

STOP RETRY : A program is stopped in the restart mode.
It is restarted from the interrupted motion.

STOP CONT : A program is stopped in the continue mode.
It is restarted from the current program step.

- [7] Bottom line: Function key menu display field
- | | | |
|---------|---|--------------------------------|
| [WATCH] | : | Variable monitor |
| [STOP] | : | Stop |
| [BREAK] | : | Interruption |
| [LDISP] | : | Display of line to be executed |

(3) Cautions

- For the functions and use of the external control signals, see the Interface Manual.
- For the data communication function with the host computer, see the Communication Manual.
- In the external automatic mode, only the MODE select switch, STOP switch, SERVO ON switch, SERVO OFF switch and EMERGENCY stop pushbutton switch provided on the control panel are operative.
- The mode can be changed through "USER. PAR".
- "EX. 232C" and "EX. ETHER" are controlled by the host computer. Enter [U00] to change over to either mode. For details, see the User Parameter Manual.
(EX. ETHER function is provided as standard in TS3000 and as an option in TSL3000.)

8.2 Selecting File

- (1) Function
Selects or resets an execution file.
- (2) Procedures
Observe one of the following manners to select a file.
 - (a) File selection by automatic start file
Create in the drive an automatic start file which specifies a selected file name by the SELECT command, then turn on the controller power.
For the automatic start file, see Section 4.
 - (b) File selection by external signal
Specify a file to be selected externally in the user parameter beforehand.
While the external signal mode is selected, an execution file can be selected by the external signal.
For the externally selected file and external signals, see the User Parameter Manual and Interface Manual, respectively.
 - (c) File selection by internal automatic mode or test operation mode (TS3000)
Select in advance a file you wish to execute in the internal automatic mode or test operation mode. Select the either mode by means of the MODE select switch on the control panel.
 - (d) File selection via data transmission
(EX. ETHER is standard for TS3000 and option for TSL3000.)
A file can be selected by data transmission in either "EX. 232C" or "EX. ETHER" mode. For details, see the Communication Manual.

When the file is selected, the following display appears.

M O D E : E X . S I G / C O N T									
								L :	
								O : 1 0 0 %	
								M : F R E E	
								S : S T O P	
								R E S E T	
L D I S P								W A T C H	

(3) Caution

- In the external control mode, an execution file cannot be selected through the teach pendant, using a command.
- Internal automatic is a TS3000 function. EX. ETHER is provided as standard in the TS3000 and as an option in the TSL3000.

8.3 Selecting Run Mode

- (1) Function
Changes over the run mode of automatic operation.
- (2) Procedures
 - (a) External control signal mode:
When the cycle operation mode signal is turned on, the cycle operation mode is selected. When the same signal is turned off, the continuous operation mode takes effect.
For the cycle operation mode signal, see the Interface Manual.
 - (b) "EX. 232C" or "EX. ETHER" mode:
Specify the run mode by sending the MODE command as an internal command for data communication (EC).
For details of sending the internal command, see the Communication Manual.
- (3) Cautions
 - In the external control signal mode, the run mode is selected by the cycle operation mode signal.
 - In the "EX. 232C" mode and "EX. ETHER" mode, the cycle operation mode signal is ineffective.
 - If the external automatic mode has replaced the internal automatic in the "EX. 232C" mode and "EX. ETHER" mode, the operation mode effective then is maintained. To specify the run mode in the host mode, send the MODE command as an internal command through data communication.
 - In the external automatic mode, you cannot specify the run mode, using the command through the teach pendant.
 - EX. ETHER function is provided as standard in TS3000 and as an option in TSL3000.

8.4 Speed Override

(1) Function

Sets the speed override for automatic operation. This function is useful to effect an additional override, taking the programmed speed as 100%.

(2) Procedures

(a) When specifying speed override in the internal automatic mode:

Specify a desired speed override beforehand in the internal automatic mode. Then change over the MODE select switch.

(b) When using an automatic start file:

Create in the RAM drive an automatic start file which designates the speed override by the OVRD command, then turn on the controller power.

For the automatic start file, see Section 4.

(3) Cautions

- A speed override which was set in the internal automatic mode or test operation mode remains effective as it is. Just after the controller power is turned on, the override is 100%.
- You can specify the speed override valid at power ON by using the OVRD command in the automatic start file.
- In the external automatic mode, you cannot specify the speed override, using the command through the teach pendant.

8.5 Startup

- (1) Function

Starts an automatic operation under the predetermined conditions.
- (2) Procedures
 - (a) Startup by using the start signal in the external signal mode:

Input the start signal.

For the start signal, see the Interface Manual.
 - (b) Startup by data communication in the "EX. 232C" mode and "EX. ETHER" mode:

Start up the program through data communication.

For the data communication, see the Communication Manual.

M O D E : E X . S I G / C O N T T E S T	
	L : 1 4 O : 1 0 0 % M : F R E E S : R U N
<div style="display: flex; justify-content: space-between;"> B R E A K S T O P W A T C H </div>	

- (3) Cautions
 - Startup can be performed, using the "startup" signal or data communication.
 - In the external control signal mode, only the "startup" signal is effective. In the host mode, only the startup by data communication takes effect.
 - The RUN switch on the TS3000 front panel is inoperative.
 - EX. ETHER function is provided as standard in TS3000 and as an option in TSL3000.

8.6 Stop

8.6.1 Cycle Stop

(1) Function

Selects "CYCLE" for the run mode and stops an automatic operation at the program end.

(2) Procedures

(a) Step 1: Input of "cycle operation mode" signal.

Input the "cycle operation mode" signal, and the cycle operation mode is selected, where an automatic operation stops at the end of the program. With the stop of the automatic operation, the "cycle end" signal is output. For the "cycle operation mode" signal and "cycle end" signal, see the Interface Manual.

(3) Cautions

- In the external control signal mode, the cycle operation mode is selected by the input of "cycle operation mode" signal. When the program has been executed to the end in the cycle operation mode, the automatic operation stops with the "cycle end" signal output.
- In the "EX. 232C" mode and "EX. ETHER" mode, the operation mode cannot be changed over by the external control signal. If the program is started in the continuous operation mode, cycle stop cannot be effected.
- The SCOL program execution unit pre-reads up to four (4) motion commands. Therefore, the program may be executed successively by up to three (3) cycles according to the cycle stop timing or the active program contents.
- EX. ETHER function is provided as standard in TS3000 and as an option in TSL3000.

8.6.2 STOP

(1) Function

Stops an automatic operation when the active command has been executed. This function is used for normal stop operation.

(2) Procedures

(a) Step 1: Input of STOP.

- "Stop" signal (only in the external control signal mode):
Input the "stop" signal. (For details, see the Interface Manual.)
- Data communication (only in the host mode):
Send the stop command. (For details, see the Communication Manual.)
- *STOP switch on controller front panel (TS3000):
Press the STOP switch.
- Teach pendant: Press the function key corresponding to the [STOP] menu.

After STOP is input, when the currently executed command has completed, the automatic operation stops. (In the TS3000, when STOP is input, the STOP LED on the controller front panel turns on.) At the same time the RUN LED on the controller front panel turns off. (In the TS3000, the STOP LED turns on at the same time.) "STOP (CONT)" is shown under "S" (execution status) on the teach pendant display.

M O D E : E X . S I G / C O N T T E S T											
							L :	1	2	3	
							O :	1	0	0	%
							M :	F	R	E	E
							S :	S	T	O	P
								C	O	N	T
L D I S P							W A T C H				

(3) Cautions

- In the "EX. 232C" mode and "EX. ETHER" mode, the "stop" signal is invalid.
- In the external control signal mode, stop by data communication is ineffective.
- For the "stop" signal and data communication, see the Interface Manual and Communication Manual, respectively.

8.6.3 BREAK

(1) Function

Immediately decelerates and stops the robot, and stops an automatic operation. This function is used to interrupt the automatic operation.

(2) Procedures

(a) Step 1: Input of BREAK.

- Teach pendant: Press the function key corresponding to the BREAK menu.
- "Stop" signal (only in the external control signal mode):
 Input the "break" signal. (For details, see the Interface Manual.)

The robot immediately slows down and stops to stop the automatic operation. (In the TS3000, when BREAK is input, the STOP LED on the controller front panel turns on.)

The RUN LED on the controller front panel turns off when the automatic operation has stopped. "STOP (RETRY)" is shown under "S" (execution status) on the teach pendant display.

M O D E : E X . S I G / C O N T T E S T									
								L : 1 2 3	O : 1 0 0 %
								M : F R E E	S : S T O P
								R E T R Y	
L D I S P								W A T C H	

(3) Caution

- To restart the operation after the stop by the BREAK command, perform the startup operation.

8.6.4 FEED HOLD

(1) Function

Holds robot motion and program execution. When this function is specified during robot operation, the robot immediately slows down and stops. The feed hold function is used to stop the robot temporarily.

(2) Procedures

(a) Step 1: Input of FEED HOLD.

Press the FEED HOLD pushbutton switch equipped on the teach pendant, and the FEED HOLD switch LED is illuminated. If the robot is working, it decelerates and stops.

(In the TS3000, when FEED HOLD is input, the STOP LED on the controller front panel turns on.)

When the automatic operation has stopped, the RUN LED on the controller front panel goes out. The display of the teach pendant is as shown below with "STOP (RETRY)" indicated under "S" (execution status).

M O D E : E X . S I G / C O N T T E S T															
								L :	1	2	3				
								O :	1	0	0 %				
								M :	F	R	E	E			
								S :	S	T	O	P			
									R	E	T	R	Y		
L	D	I	S	P							W	A	T	C	H

(b) Step 2: Cancel of feed hold.

While the FEED HOLD switch LED is turned on, press the FEED HOLD switch again. The FEED HOLD switch LED turns off and the automatic operation restarts.

If feed hold was commanded during program execution, program execution can be restarted by canceling the feed hold.

When the program has restarted, the RUN LED on the controller front panel is illuminated.

(In the TS3000, when FEED HOLD is canceled, the STOP LED on the controller front panel turns off.)

"RUN" is shown under "S" (execution status) on the teach pendant display.

M O D E : E X . S I G / C O N T T E S T						
	L : 1 4 O : 1 0 0 % M : F R E E S : R U N					
B R E A K	S T O P					W A T C H

(3) Cautions

- If the feed hold was commanded during program execution, program execution can be restarted by canceling the feed hold.
- If you should change the master mode, select a file or reset the execution conditions, the program will not restart.

8.6.5 EMERGENCY Stop

(1) Function

Turns off the servo power and stops an automatic operation. This function is useful to stop the robot system at the time of an emergency.

(2) Procedures

Press the EMERGENCY stop pushbutton switch equipped on the teach pendant, or use the "emergency stop" external control signal.

(The TS3000 can also be stopped by the emergency stop switch on the controller front panel.)

When an emergency stop is input, the servo power is turned off, and the LED of the SERVO ON switch of the teach pendant turns off.

Also, the SERVO ON (SVON in the TSL3000) LED on the controller front panel turns off.

(In the TS3000, the SERVO OFF LED turns on at the same time.)

(3) Cautions

- All of the EMERGENCY stop switches on the control panel and teach pendant, and "emergency stop" external control signal are operative. At the time of an emergency, use whichever key you can get at quickest.
- The EMERGENCY stop switches on the control panel and teach pendant are of a lock type. When pressed, they remain depressed and locked. To reset, turn and unlock the switch.
- While the EMERGENCY stop switch is ON, the servo power cannot be turned on.

8.7 Reset

(1) Function

(1-1) Program reset

Resets all execution conditions (execution steps, variables) for a current file and allows execution of that program from the top.

This function is useful to execute a current file from the top of the program.

(1-2) Step reset

Resets all execution conditions (excluding global variables) for a current file and allows execution of that program from the top.

(1-3) Cycle reset

Resets all execution conditions (excluding global variables) for a current file and allows execution of the main program from the step indicated by label RCYCLE. This function is useful when you do not wish to execute the setting of the initial condition. Also, specify the GOTO RCYCLE command just before the END command not to execute the END command of the main program.

(1-4) Output signal reset

Sets off all user external output signals (DOUT (1) ~ DOUT (164)). The hand signals (201 ~ 204) will not turn off.

(2) Procedures

- External control signal mode:
Turn on the input signal corresponding to the program reset, step reset, cycle reset, or output signal reset.
In the external control signal mode, reset by data communication is not possible. For details, see the Interface Manual.
- "EX. 232C" mode and "EX. ETHER" mode:
Send the command corresponding to the reset operation you wish to perform through data communication. If the command is accepted by the controller, an "acknowledge" signal is sent back from the controller.
In the host mode, reset by external control signal is not possible. For details, see the Communication Manual.

(3) Cautions

- In the program reset mode, all variables used in the program are reset. If you do not wish to the variables, use the step reset function instead.
- If you do not wish to execute the setting of initial conditions at the head of the program, use the cycle reset instead.
- In the cycle reset mode, use label RCYCLE in a desired step of the main program.
- EX. ETHER function is provided as standard in TS3000 and as an option in TSL3000.

8.8 Variable Monitor

- (1) Function
Displays the values of a desired global variable.
- (2) Procedures
 - (a) Step 1: Command selection.
Press the NEXT key repeatedly until [WATCH] is displayed in the menu, and press the corresponding function key.
 - During stop

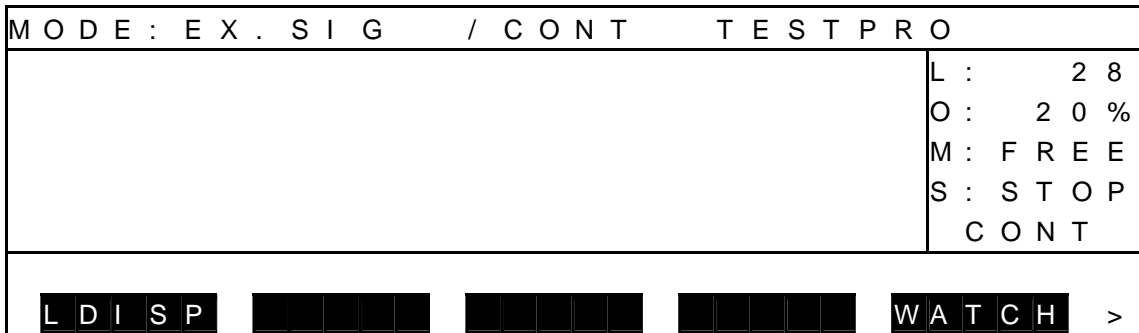

- During run

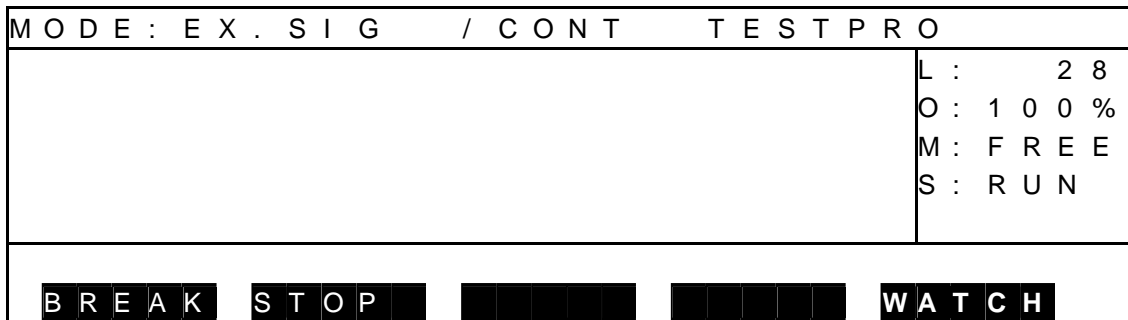

Press the [WATCH] function key, and the variable monitor display appears.

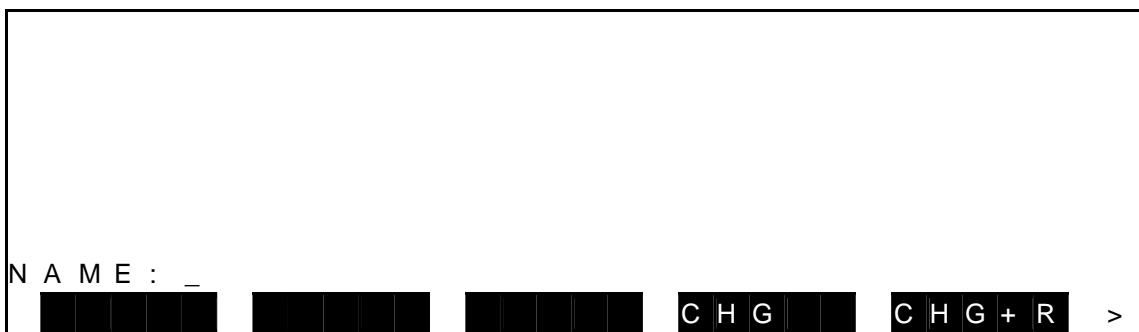

- * The global variable signifies the variable (real number type, integer type, position type, coordinate type or load type) as defined in the area flanked by GLOBAL-END, or by DATA-END (for the variable which can be edited by the DEDIT function) in the program.

(b) Step 2: Input of variable name.

Enter a variable name you wish to monitor, then press the EXE key. The variable name thus input and its values are displayed.

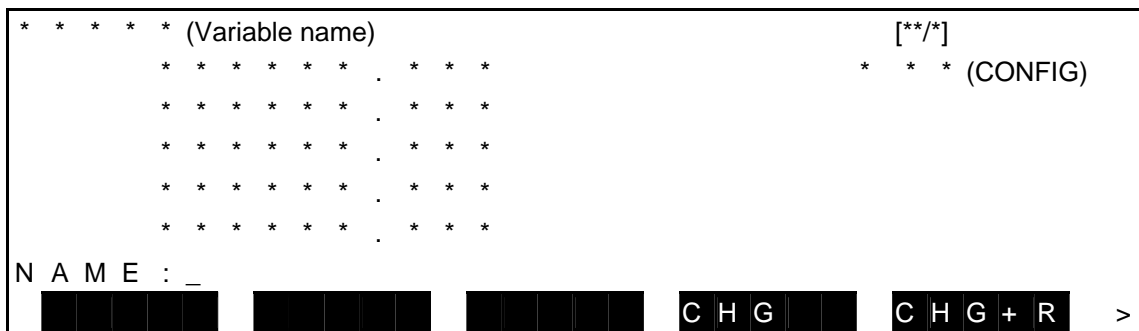

Unless the specified variable exists in the program, "-----,---" is displayed. Up to thirty (30) variable names can be registered.

(c) Step 3: Changeover of monitor variable display.

Monitor variable display can be changed over in the following manner.

Display of the next variable and after	Press the ↓ key.
Display of the previous variable and before	Press the ↑ key.
Display of an already registered variable	Enter the already registered variable.

(d) Step 4: Change of variable value [CHG].

It is possible to change a programmed value temporarily. (To rewrite the initial value in the program, execute [CHG+R].)

[1] Press the [CHG] key, and the following display is called.

[2] A reversed indication can be shifted up or down by means of the ↑ or ↓ key, respectively.

When the cursor is set to an element you wish to change, the relevant value of the selected element is displayed as [CHANGE : *****.***■]. Change the value and press the EXE key, then the value is updated.

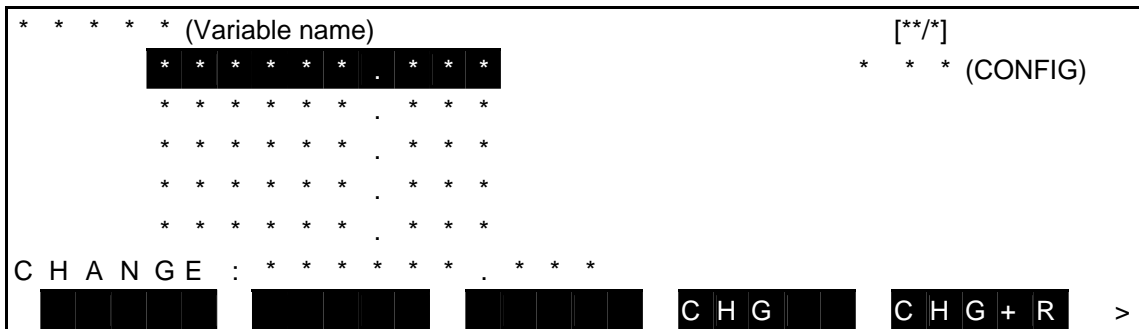

(e) Step 5: Change of variable [CHG+R].

It is possible to change the initial value in the program. By this operation, a statement itself in the program is rewritten.

[1] Press the [CHG+R] key, and the following display is called.

[2] A reversed indication can be shifted up or down by means of the ↑ or ↓ key, respectively.

When the cursor is set to an element you wish to change, the relevant value of the selected element is displayed as [CHANGE+RESTORE : *****.***■]. Change the value and press the EXE key, then the value is updated.

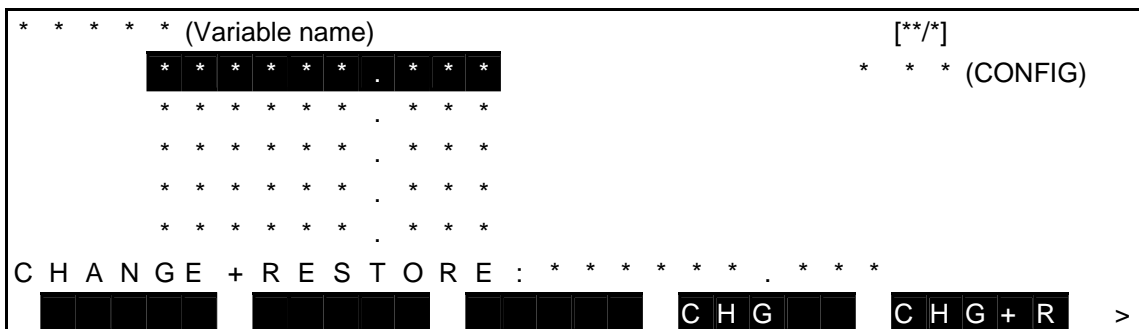

(f) Step 6: Deletion of registered monitor variable.

Change over the monitor variable display until a variable you wish to delete is displayed. Then press the ALT and BS keys (DEL) at the same time.

(g) Step 7: End of variable monitor.

Press the ESC key, and the system returns to the previous display of each mode.

**CAUTION**

- Unless any program is selected, displayed value may not be correct.
- The [CHG+R] function cannot be executed for the global variable yet to be initialized (such as position type array variable which is not taught the robot).
(If you are about to execute this, the error message saying "**Can not RESTORE**" is displayed.)
- The position type data can be changed in the range of **±3 mm or ±3 deg.**

8.9 Display of Line to be Executed

- (1) Function
Displays the execution program.
- (2) Operating procedure
 - (a) Step 1: Command selection.
Press the NEXT key to display [LDISP] in the menu, and then press the corresponding function key.

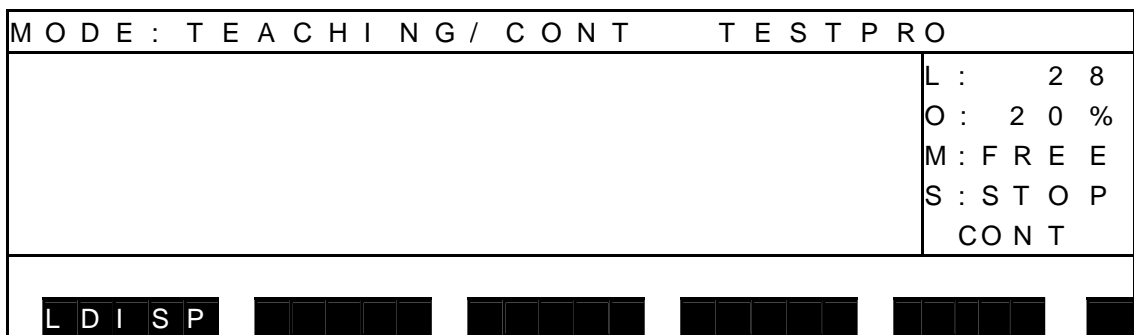

- (b) Step 2: Change the monitor variable display.
Press the F1 key to change between the SCROLL screen and CURRENT screen.
- SCROLL screen (when program is stopped)

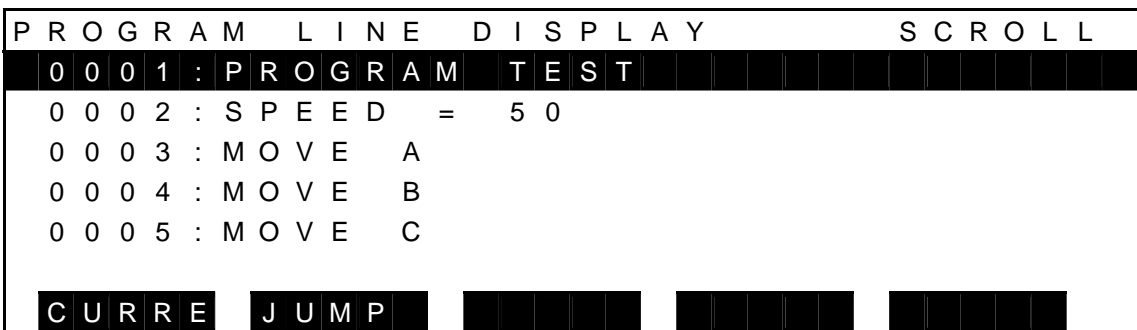

During program execution



The execution program can be viewed in this screen.
For details on the JUMP function, see "Description on Edit Commands" in Section 4.

- CURRENT screen (when program is stopped)

P	R	O	G	R	A	M	L	I	N	E	D	I	S	P	L	A	Y	C	U	R	R	E	N	T
0	0	0	1	:	P	R	O	G	R	A	M	T	E	S	T									
0	0	0	2	:	S	P	E	E	D	=	5	0												
0	0	0	3	:	M	O	V	E	A															
0	0	0	4	:	M	O	V	E	B															
0	0	0	5	:	M	O	V	E	C															
S	C	R	L	L						R	U	N												

During program execution

S	C	R	L	L						B	R	E	A	K	S	T	O	P					
---	---	---	---	---	--	--	--	--	--	---	---	---	---	---	---	---	---	---	--	--	--	--	--

In this screen, the block that is currently being executed is highlighted for indicating which part of the program is being executed.

For details on the BREAK function and STOP function, see "Stop" in Para 8.6.

- (3) Caution
[LDISP] is not displayed in STEP mode.

Section 9 File Operation

9.1 Directory Display [DIR]

(1) Function

Displays a file name directory registered in the RAM drive and USB drive (TS3000 folder).

(2) Procedures

(a) Step 1: File mode selection.

Press the NEXT key repeatedly until [FILE] is displayed in the menu. Press the corresponding function key then.

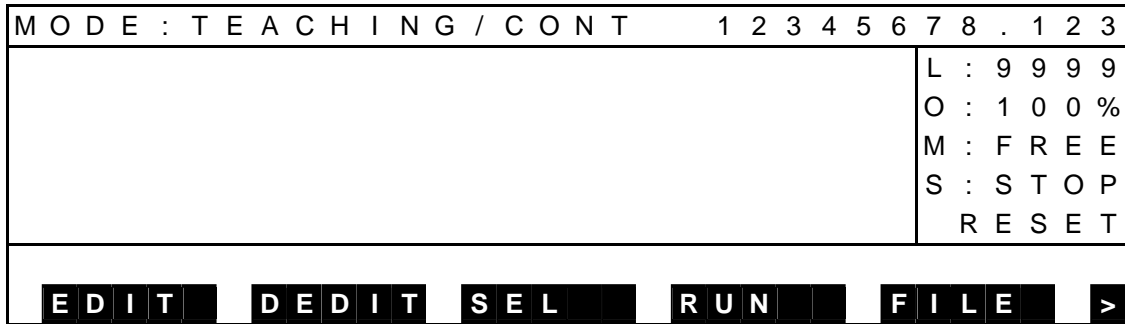

Press the FILE and the following display appears.

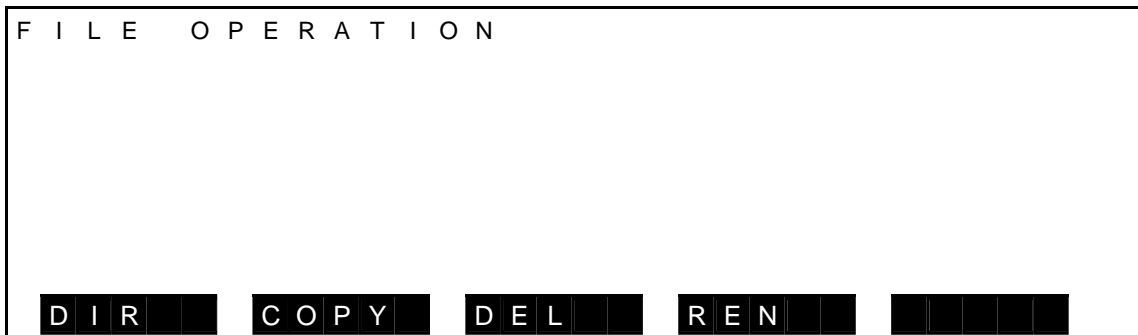

Operations of each command menu are shown below.

Menu	Descriptions
[DIR]	Displays a directory of files in the RAM drive and USB drive. * Displays a directory of files in the TS3000 folder for the USB drive.
[COPY]	Copies files. See Para 9.2.
[DEL]	Deletes files. See Para 9.3.
[REN]	Changes file names. See Para 9.4.

(b) Step 2: Command selection.

Press [DIR], and a directory of all files registered is displayed.

The screenshot shows a directory listing for the RAM drive. The header is "R A M : [* * * / * * *]". Below it are five lines of file information, each with columns for file name, size, and date. Arrows 1 and 2 point to the first and second columns of the first line. Below the listing is a navigation bar with "NAME", "TIME", and "USB" labels. Arrows 3, 4, and 5 point to the "NAME", "TIME", and "USB" labels respectively.

```

R A M : [ * * * / * * * ]
A B C D 1 2 3 4 . 5 6 7 1 2 3 4 5 6 F e b - 1 2 - 2 0 0 8
F I L E 0 0 0 2 . 0 1 2 1 2 3 4 5 6 F e b - 1 3 - 2 0 0 8
F I L E 0 0 0 3 . 0 1 2 1 2 3 4 5 6 F e b - 1 4 - 2 0 0 8
F I L E 0 0 0 4 . 0 1 2 1 2 3 4 5 6 F e b - 1 5 - 2 0 0 8
F I L E 0 0 0 5 . 0 1 2 1 2 3 4 5 6 F e b - 1 6 - 2 0 0 8
NAME TIME USB
  
```

Press the USB and the following menu is selected to display a directory of files contained in the TS3000 folder in the USB drive.

The screenshot shows the navigation bar with "NAME", "TIME", and "RAM" labels. The "RAM" label is highlighted, indicating it is the selected option.

```

NAME TIME RAM
  
```

Display contents:

- ① Order of a file shown on the 1st line.
- ② Total number of files
- ③ File name
- ④ File size in bytes
- ⑤ Date of file creation (or alteration)

Keys operative in this mode and their operations are shown below.

Key	Descriptions
↑	Used to display the contents which are just one (1) line before the cursor line.
↓	Used to display the contents which are just one (1) line after the cursor line.
ALT + ↑	Used to display the contents of the just preceding page.
ALT + ↓	Used to display the contents of the just succeeding page.
F1	Used to sort the data by file name.
F2	Used to sort the data by date.
ESC	Used to return the system to the previous display.

(3) Cautions

- If a USB drive is selected in any of the operation processes, the USB drive will not be recognized unless there is a "TS3000" folder (directory) in the drive. Therefore, before performing any file operations, check that there is a TS3000 folder (directory) in the USB drive.
- If there is no TS3000 folder (directory) in the USB drive, create one.

9.2 File Copy [COPY]

(1) Function

Copies one file to another file. Both program section and data section are copied. This function is used to back up the editing and create a similar file.

(2) Procedures

(a) Step 1: File mode selection.

Press the NEXT key repeatedly until [FILE] is displayed in the menu. Press the corresponding function key then.

M O D E : T E A C H I N G / C O N T										1	2	3	4	5	6	7	8	.	1	2	3																		
																	L	:	9	9	9	9																	
																	O	:	1	0	0	%																	
																	M	:	F	R	E	E																	
																	S	:	S	T	O	P																	
																	R	E	S	E	T																		
E		D		I		T		D		E		D		I		T		S		E		L		R		U		N		F		I		L		E		>	

Press the FILE and the following display appears.

F I L E O P E R A T I O N																																					
D		I		R		C		O		P		Y		D		E		L		R		E		N													

(b) Step 2: Command selection.

Press [COPY].

If you press the ESC key without any character input in the step below, you can exit this mode.

For the operation of each function key, see Para. 6.2.

Press the USB and you can select a file in the USB drive from the source files.

```

FILE COPY FROM ( 0 0 1 / 0 2 0 )
ABC 2 5 7 Feb - 0 5 - 2 0 0 8
FILE 0 0 0 2 5 6 Feb - 1 3 - 2 0 0 8
FILE 0 0 1 0 1 2 3 4 Mar - 2 4 - 2 0 0 8
PICK 0 0 2 4 . PRO 4 5 6 Jun - 1 5 - 2 0 0 8
TEST PRO 1 3 2 5 Jul - 1 2 - 2 0 0 8

NAME TIME INPUT USB
    
```

(c) Step 3: Input of source file name.

Select a desired source file name, using the cursor, then press the EXE key. The file name thus selected is displayed on the command line. If it is OK, press the EXE key. It is also possible to change the file name by deleting one (1) character by means of the BS key or all characters by means of the ESC key.

```

: ABC █
    
```

(d) Step 4: Input of copied file name.

Select a file name where you wish to copy the source file.

If you press the ESC key without any character input in the following step, the system returns to the source file name input mode.

```

RAM: FILE COPY TO RAM ( 0 0 1 / 0 2 0 )
ABC 2 5 7 Feb - 0 5 - 2 0 0 8
FILE 0 0 0 2 5 6 Feb - 1 3 - 2 0 0 8
FILE 0 0 1 0 1 2 3 4 Mar - 2 4 - 2 0 0 8
PICK 0 0 2 4 . PRO 4 5 6 Jun - 1 5 - 2 0 0 8
TEST PRO 1 3 2 5 Jul - 1 2 - 2 0 0 8

NAME TIME INPUT USB
    
```

After selecting the copied file name, press the EXE key. When you wish to create a new file, press [INPUT] and enter the file name.

The selected file name can also be changed like the source file name. The USB drive can be selected as the copy target by pressing [USB]. When copying a file from the RAM to the USB or from the USB to the RAM, the copy source file name is already input.

If you press the ESC key, you can delete a file name. If you further press the same key, the system returns to the source file name input mode.

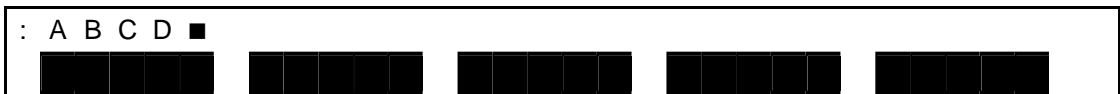

Make sure that the input file name is correct, then press the EXE key.

(e) Step 5: Input through EXE key.

When the confirmation message appears, make sure of the input file name again. Then press the EXE key.



[R:] represents RAM, and [U:] represents USB.

(f) Step 6: Input through ANY key.

When the file has been copied, the following message appears.

When you press any key on the teach pendant, the system returns to Step 2 and you can continue copying.



If the copied file name specified already exists, the system waits for your answer, displaying a message saying "Already exist. Delete?".

```
C o p y   R : A B C   - >   R : A B C D ?
A l r e a d y   e x i s t . D e l e t e ?
O K   T H E N   < E X E >
```

If you wish to delete the already registered file, press the EXE key. If you do not wish to delete it, press the ESC key.

If the copy source file name is identical to the copy target file name, the error message "ILLEGAL OPERAND" is displayed, and the operation is canceled.

```
C o p y   R : A B C   - >   R : A B C D ?
I L L G A L   O P E R A N D ! !
H I T   A N Y   K E Y
```

(3) Cautions

- If the size of the copying data exceeds the memory capacity as a result of the copy operation, an error message of "RAM file I/O error" is displayed.
- If the number of files registered in the RAM drive exceeds the limit by the copy operation, the system waits for key input, displaying an error message of "MTX file I/O error" or "RAM file I/O error".
- Delete any unnecessary file or files and try again.
- Unless the source file exists, an error message saying "[File name] Not found" is displayed, and this operation becomes invalid.
- You cannot copy a file to the file selected as the execution file. When this happens, an error message saying "[File name] file already selected" is displayed.

9.3 File Rename [REN]

- (1) Function
Renames a file.
- (2) Procedures
 - (a) Step 1: File mode selection.
Press the NEXT key repeatedly until [FILE] is displayed in the menu. Press the corresponding function key then.

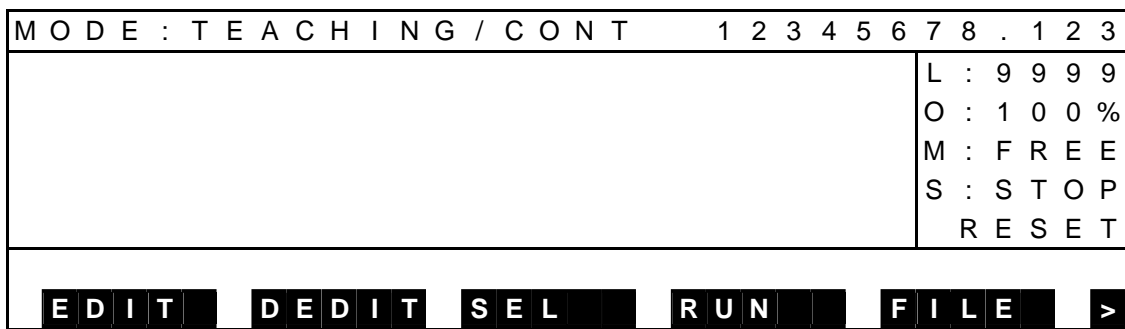

Press the FILE and the following display appears.

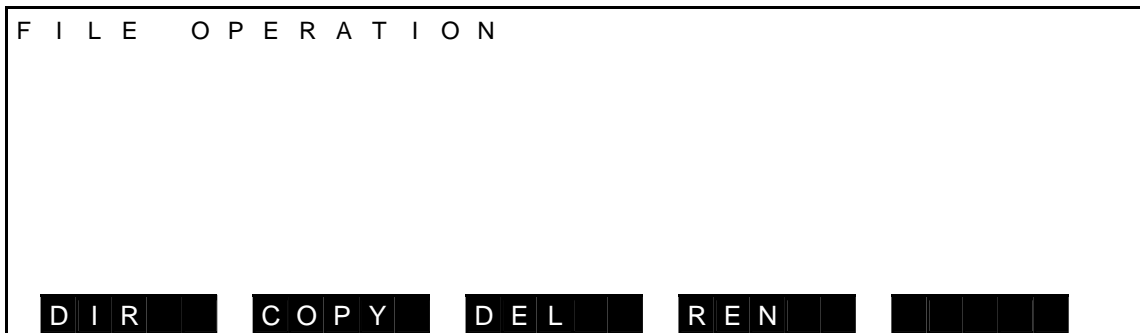

(b) Step 2: Command selection.

Press [REN].

If you press the ESC key without any character input in the step below, you can exit this mode.

Press the USB and you can change the file name in the USB drive.

```

RAM: FILE RENAME FROM ( 0 0 1 / 0 2 0 )
ABC 2 5 7 Feb - 0 5 - 2 0 0 8
FILE 0 0 0 2 5 6 Feb - 1 3 - 2 0 0 8
FILE 0 0 1 0 1 2 3 4 Mar - 2 4 - 2 0 0 8
PICK 0 0 2 4 . PRO 4 5 6 Jun - 1 5 - 2 0 0 8
TEST PRO 1 3 2 5 Jul - 1 2 - 2 0 0 8

NAME TIME INPUT USB
    
```

(c) Step 3: Input of file name before change.

Select a file name before change, using the cursor, then press the EXE key. The file name thus selected is displayed on the command line. If it is OK, press the EXE key. It is also possible to change the file name by deleting one (1) character by means of the BS key or all characters by means of the ESC key.

```

: ABC
    
```

(d) Step 4: Input of file name after change.

Select a file name after change.

If you press the ESC key without any character input in the following step, the system returns to the "input of file name before change" mode.

```

RAM: FILE RENAME TO ( 0 0 1 / 0 2 0 )
ABC 2 5 7 Feb - 0 5 - 2 0 0 8
FILE 0 0 0 2 5 6 Feb - 1 3 - 2 0 0 8
FILE 0 0 1 0 1 2 3 4 Mar - 2 4 - 2 0 0 8
PICK 0 0 2 4 . PRO 4 5 6 Jun - 1 5 - 2 0 0 8
TEST PRO 1 3 2 5 Jul - 1 2 - 2 0 0 8

NAME TIME INPUT
    
```

After selecting the file name after change, press the EXE key. When you wish to create a new file, press [INPUT] and enter the file name. The selected file name can also be changed like the file name before change. If you press the ESC key, you can delete a file name. If you further press the same key, the system returns to the "input of file name before change" mode.



Make sure that the input file name is correct, then press the EXE key.

(e) Step 5: Input through EXE key.

When the confirmation message appears, make sure of the input file name again. Then press the EXE key.



(f) Step 6: Input through ANY key.

When the file has been renamed, the following message appears.

When you press any key on the teach pendant, the system returns to Step 2 and you can continue renaming.



If the specified file name before change already exists, the system waits for your answer, displaying a message saying "Already exist. Delete?".

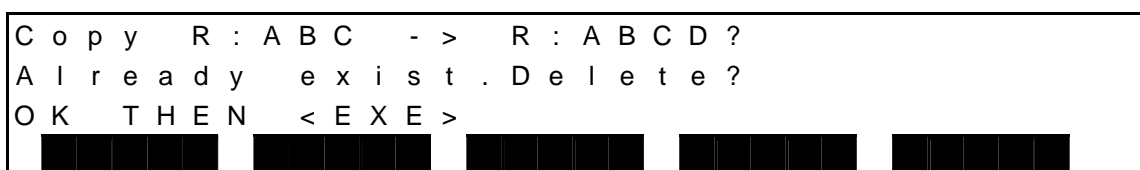

If you wish to delete the already registered file, press the EXE key. If you do not wish to delete it, press the ESC key.

If the copy source file name is identical to the copy target file name, the error message "ILLEGAL OPERAND" is displayed, and the operation is canceled.

```
R e n a m e   R : A B C D   - >   R : A B C D ?  
I L L G A L   O P E R A N D ! !  
H I T   A N Y   K E Y  
██████████ ██████████ ██████████ ██████████ ██████████
```

(3) Cautions

- Unless the file name before change exists, an error message of "[File name] Not found" is displayed, and this operation becomes invalid.
- If you try to rename a file selected as the execution file, an error message saying "[File name] file already selected" is displayed, and this operation is ineffective.
- If the file name after change is identical with the file selected as the execution file, an error message saying "[File name] file already selected" is displayed, and this operation is ineffective.

9.4 File Delete [DEL]

- (1) Function
Deletes a specified file. This function is used to delete an unnecessary file or files when no free area is left in the RAM drive.
- (2) Procedures
 - (a) Step 1: File mode selection.
Press the NEXT key repeatedly until [FILE] is displayed in the menu. Press the corresponding function key then.

M O D E : T E A C H I N G / C O N T	1 2 3 4 5 6 7 8 . 1 2 3
	L : 9 9 9 9 O : 1 0 0 % M : F R E E S : S T O P R E S E T
E D I T D E D I T S E L R U N F I L E >	

Press the FILE and the following display appears.

F I L E O P E R A T I O N
D I R C O P Y D E L R E N

(b) Step 2: Command selection.

Press [DEL].

If you press the ESC key without any character input in the step below, you can exit this mode.

Press the USB and you can delete the file in the USB drive.

```

RAM: FILE DELETE ( 0 0 1 / 0 2 0 )
A B C 2 5 7 F e b - 0 5 - 2 0 0 8
FILE 0 0 0 2 5 6 F e b - 1 3 - 2 0 0 8
FILE 0 0 1 0 1 2 3 4 M a r - 2 4 - 2 0 0 8
P I C K 0 0 2 4 . P R O 4 5 6 J u n - 1 5 - 2 0 0 8
T E S T P R O 1 3 2 5 J u l - 1 2 - 2 0 0 8

NAME TIME INPUT USB
    
```

(c) Step 3: Input of file name to be deleted.

Select a file name you wish to delete and press the EXE key. If there are many files to be deleted, use wild cards or execute this function over a few times. The file name thus selected is displayed on the command line.

When you press the ESC key, a file name can be deleted. If you further press the same key, you can select a file name again.

```

: A B C
    
```

Make sure that the input file name is correct, then press the EXE key.

(d) Step 4: Input through EXE key.

After the confirmation message appears, make sure that your entry is correct, and press the EXE key.

```

Delete R : A B C ?
OK THEN < EXE >
    
```

(e) Step 5: Input through any key.

When the file has been deleted, the following message appears.

When you press any key on the teach pendant, the system returns to Step 2 and you can continue deleting.

```

D e l e t e   R : A B C ?
C o m p l e t e d .
H I T   A N Y   K E Y
  
```

When you use the wild card (*.*) , the system waits for your answer, displaying a message of "Are you sure?".

```

A r e   y o u   s u r e ?
O K   T H E N   < E X E >
  
```

When you wish to delete all files, press the EXE key. When you do not wish to delete them, press the ESC key.

(3) Cautions

- If you use the wild card (*.*) for the RAM drive, you will clear the reserved files too.
- A file selected as the execution file cannot be deleted. When this happens, an error message saying "File name file already selected" is displayed.

Section 10 Utility

The utility mode allows external input/output signal display, current position display, selection of work/tool coordinate system, etc. It can be used in the teaching, internal automatic and external automatic modes.

When you press the ESC key, the system returns to the previous display, quitting the utility mode.

10.1 Selecting Utility Mode

- (1) Function
 - Selects the utility mode.
- (2) Procedures
 - (a) Step 1: Utility mode selection.
 - Press the UTILITY key equipped on the teach pendant, and the following display appears.

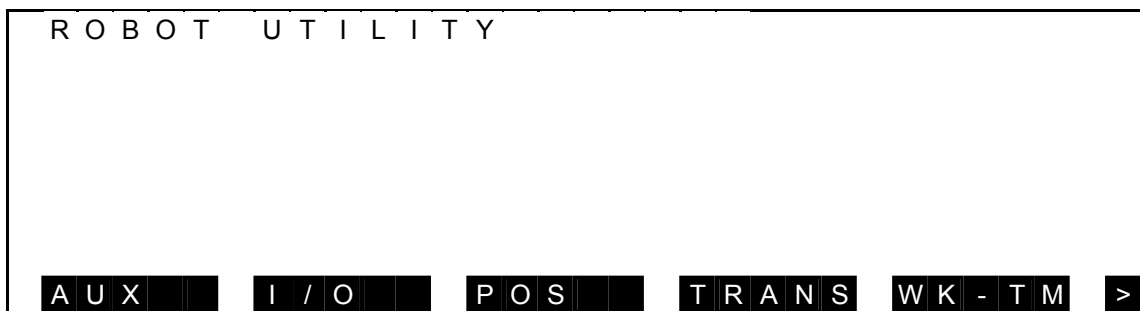

Each time the NEXT key is pressed, the menu is changed over as follows.



The key operative in this mode and its operation are shown below.

Key	Descriptions
[ESC]	Used to quit the utility mode and return the system to the previous display.

Operations of each command menu are shown below.

Menu	Descriptions
[AUX]	Used to display the auxiliary signals.
[I/O]	Used to display the external input/output signals.
[POS]	Used to display the robot positions.
[TRANS]	Used to select the work coordinate system or tool coordinate system.
[WK-TM]	Used to display and set the robot working time.
[REORG]	Used to reproduce the origin (or home point). Note: This function is intended for the maintenance. For details, see the Maintenance Manual provided separately.
[J-LIM]	Used to display the joint limit set values and set a joint limit value as necessary.
[DATE]	Used to display and set the current date and time.
[MOTOR]	Used to display the servo motor torque, electronic thermal total value and load factor.

Menu	Descriptions
[ENC]	Used to display the servo encoder data. Note: This function is intended for the maintenance. Operate this key according to the instructions of our service engineers.
[PLC-M]	Used to display the PLC data.
[MEMOR]	Used to display the system internal memory. Note: This function is intended for the maintenance. Operate this key according to the instructions of our service engineers.
[ZEROP]	Used to set the origin (or home point). Note: This function is intended for the maintenance. Operate this key according to the instructions of our service engineers.
[VER]	Used to display the system version.
[CONV]	Used to display each status of the conveyor synchronization function. Note: For details, see the Conveyor Synchronous Function Instruction Manual provided separately.
[ETHER]	Used to display the Ethernet status. Note: For details, see the Communication Manual provided separately. ETHER function is provided as standard in TS3000 and as an option in TSL3000.
[PAYLD]	Used to display PAYLOAD set values for manual operation and set a PAYLOAD value as necessary.
[FCTRY]	Note: This is a function for initialization at shipment. Users must not use.
[BCKUP]	Used to display backup operation to the flash memory.

(3) Caution

This function can be used in the teaching, internal automatic and external automatic modes.

10.2 Auxiliary Signal Display [AUX]

- (1) Function
Displays the status of auxiliary signals.
- (2) Procedures
 - (a) Step 1: Command selection.
Press the NEXT key repeatedly until [AUX] is displayed in the menu. Press the corresponding function key, and the following auxiliary signal display appears.

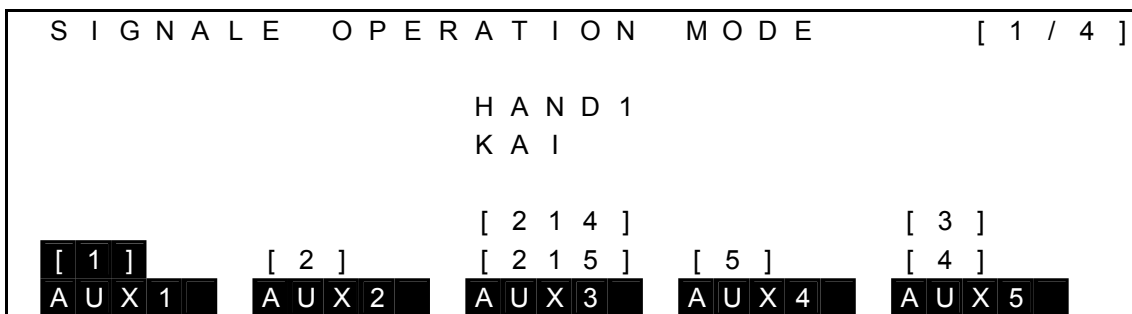

- The numbers on the display correspond to the output signal ports.
- Auxiliary signals having two (2) output signal ports are set for the double solenoid, and those having one (1) output signal port are intended for the single solenoid. Those having no output signal ports are not intended for anything.
- Ports inversely displayed are ON and ports not inversely displayed are OFF. (On the above display, only [1] is ON.)
- It is possible to display messages for respective signals on the 3rd to 4th lines of the display only when they are defined in the user parameter file beforehand. (For further information, see the Parameter Manual.)

Example: Content of USER. PAR file

```

•
= 0 0 0 2 0 1 "Hand out 1"
• (19 lines will continue below.)
•
    
```

Note
□: Space (Insert space mark in blank lines.)

(For details, see the User Parameter Manual.)

Keys operative in this mode and their operations are shown below.

Key	Descriptions
ALT + ↓	Used to display the next page. If the cursor is located at the final page, the page will not change over.
ALT + ↑	Used to display the previous page. If the cursor is located at the top page, the page will not change over.
ESC	Used to return the system to the utility display.

Operation of each command menu is shown below.

Menu	Descriptions
[AUXn]	Each time this key is pressed, the solenoid state changes from ON to OFF or vice versa. For the double solenoid, the state of two (2) ports are changed over alternately.

(3) Cautions

- The output signal port and solenoid type corresponding to each command menu should be defined in the user parameter file in advance. For more information, see the User Parameter Manual.
- During emergency stop, auxiliary signals can be turned on and off. The initial state at power ON, including signals which are set for the double solenoid, is OFF.

10.3 External Input/Output Signal Display [I/O]

(1) Function
 Displays the status of external input/output signals.

(2) Procedures

(a) Step 1: File mode selection.

Press the NEXT key repeatedly until [I/O] is displayed in the menu. Press the corresponding function key, and the following hand input/output signal status display appears.

I / O	M o n i t o r	(S t a n d a r d	I N)	1 / 5
	1	1 0	1 1	2 0
D I N 0 *	0 0 0 0 0	0 0 0 0 0	0 0 0 0 0	0 0 0 0 0
2 *	0 0 0 0 0	0 0 0 0 0	0 0 0 0 0	0 0 0 0 0
4 *	0 0 0 0 0	0 0 0 0 0	0 0 0 0 0	0 0 0 0 0
6 *	0 0 0 0			
<div style="display: flex; justify-content: space-around; margin-top: 10px;"> D I N D O U T S Y S </div>				

For the display contents, see Step 2 below.

Keys operative in this mode and their operations are shown below.

Key	Descriptions
←	Used to move the cursor to the left. When the cursor is located on the left end, it will not move at all. This key is effective when the [ON] menu or [OFF] menu is displayed.
→	Used to move the cursor to the right. When the cursor is located on the right end, it will not move at all. This key is effective when the [ON] menu or [OFF] menu is displayed.
↑	Used to move the cursor up. When the cursor is located at the top, it will not move at all. This key is effective when the [ON] menu or [OFF] menu is displayed.
↓	Used to move the cursor down. When the cursor is located at the bottom, it will not move at all. This key is effective when the [ON] menu or [OFF] menu is displayed.

ALT + ↓ or NEXT	Used to display the next page. If the cursor is located at the final page, the top page is selected.
ALT + ↑ or ALT + NEXT	Used to display the previous page. If the cursor is located at the top page, the final page is selected.
ESC	Used to return the system to the utility display.

Operations of each command menu are shown below.

Menu	Descriptions
[ON]	Used to set ON the bit indicated by the cursor.
[OFF]	Used to set OFF the bit indicated by the cursor.
[DIN]	Used to move to DIN display (user external input).
[DOUT]	Used to move to DOUT display (user external output).
[SYS]	Used to move to SYS (system) display.

(b) Step 2: Change of display.

Press the ALT + ↓ keys or the NEXT key (or ALT + ↑, ALT + NEXT) at the same time, and the display items are changed over. Display contents of each page are shown below.

① DIN (User external input)

Page 1 (general input)

I / O	M o n i t o r	(S t a n d a r d	I N)	1 / 5
	1	1 0	1 1	2 0
D I N 0 *	0 0 0 0 0	0 0 0 0 0	0 0 0 0 0	0 0 0 0 0
2 *	0 0 0 0 0	0 0 0 0 0	0 0 0 0 0	0 0 0 0 0
4 *	0 0 0 0 0	0 0 0 0 0	0 0 0 0 0	0 0 0 0 0
6 *	0 0 0 0			
		D I N	D O U T	S Y S

Page 2 (expansion input)

I / O	Monitor	(Extended IN)				2 / 5
	1	1 0	1 1		2 0	
D I N	1 0 *	0 0 0 0 0	0 0 0 0 0	0 0 0 0 0	0 0 0 0 0	
	1 2 *	0 0 0 0 0	0 0 0 0 0	0 0 0 0 0	0 0 0 0 0	
	1 4 *	0 0 0 0 0	0 0 0 0 0	0 0 0 0 0	0 0 0 0 0	
	1 6 *	0 0 0 0				

D I N
D O U T
S Y S

Page 3 (system input)

I / O	Monitor	(System IN)				3 / 5
	1	1 0	1 1		2 0	
D I N	2 0 *	0 0 0 0 0	0 0 0 0 0	0 0 0 0 0	0 0 0 0 0	
	2 2 *	0 0 0 0 0	0 0 0 0 0	0 0 0 0 0	0 0 0 0 0	
	2 4 *	0 0 0 0 0	0 0 0 0 0	0 0 0 0 0	0 0 0 0 0	
	2 6 *	0 0 0 0				

D I N
D O U T
S Y S

Page 4 (field bus input 1)

I / O	Monitor	(Field bus 1 IN)				4 / 5
	1	1 0	1 1		2 0	
D I N	3 0 *	0 0 0 0 0	0 0 0 0 0	0 0 0 0 0	0 0 0 0 0	
	3 2 *	0 0 0 0 0	0 0 0 0 0	0 0 0 0 0	0 0 0 0 0	
	3 4 *	0 0 0 0 0	0 0 0 0 0	0 0 0 0 0	0 0 0 0 0	
	3 6 *	0 0 0 0				

D I N
D O U T
S Y S

Page 5 (field bus input 2)

I / O	Monitor	(Field bus 2 IN)				5 / 5
	1	1 0	1 1		2 0	
D I N	4 0 *	0 0 0 0 0	0 0 0 0 0	0 0 0 0 0	0 0 0 0 0	
	4 2 *	0 0 0 0 0	0 0 0 0 0	0 0 0 0 0	0 0 0 0 0	
	4 4 *	0 0 0 0 0	0 0 0 0 0	0 0 0 0 0	0 0 0 0 0	
	4 6 *	0 0 0 0				

D I N
D O U T
S Y S

- The I/O signal status is represented by "1" for open contacts and by "0" for close contacts.
- One line contains 20 signals which are separated at every 5 signals, and the number of the signal at the head of the signal string is displayed at the left end of the line.

- The number of signals is 64.

② DOUT (User external output)

Page 1 (general output)

I / O	Monitor	(Standard OUT)	1 / 5
	1	10 11	20
DOUT 0 *	0 0 0 0 0	0 0 0 0 0	0 0 0 0 0
DOUT 2 *	0 0 0 0 0	0 0 0 0 0	0 0 0 0 0
DOUT 4 *	0 0 0 0 0	0 0 0 0 0	0 0 0 0 0
DOUT 6 *	0 0 0 0 0		

ON OFF DIN DOUT SYS

Page 2 (expansion output)

I / O	Monitor	(Extended OUT)	2 / 5
	1	10 11	20
DOUT 10 *	0 0 0 0 0	0 0 0 0 0	0 0 0 0 0
DOUT 12 *	0 0 0 0 0	0 0 0 0 0	0 0 0 0 0
DOUT 14 *	0 0 0 0 0	0 0 0 0 0	0 0 0 0 0
DOUT 16 *	0 0 0 0 0		

ON OFF DIN DOUT SYS

Page 3 (system output)

I / O	Monitor	(System OUT)	3 / 5
	1	10 11	20
DOUT 20 *	0 0 0 0 0	0 0 0 0 0	0 0 0 0 0
DOUT 22 *	0 0 0 0 0	0 0 0 0 0	0 0 0 0 0
DOUT 24 *	0 0 0 0 0	0 0 0 0 0	0 0 0 0 0
DOUT 26 *	0 0 0 0 0		

DIN DOUT SYS

Page 4 (field bus output 1)

I / O	Monitor	(Fieldbus 1 OUT)	4 / 5
	1	10 11	20
DOUT 30 *	0 0 0 0 0	0 0 0 0 0	0 0 0 0 0
DOUT 32 *	0 0 0 0 0	0 0 0 0 0	0 0 0 0 0
DOUT 34 *	0 0 0 0 0	0 0 0 0 0	0 0 0 0 0
DOUT 36 *	0 0 0 0 0		

ON OFF DIN DOUT SYS

Page 5 (field bus output 2)

I / O	M o n i t o r	(F i l d b u s 2 O U T)	5 / 5
	1	1 0 1 1	2 0
D O U T 4 0 *	0 0 0 0 0	0 0 0 0 0	0 0 0 0 0
D O U T 4 2 *	0 0 0 0 0	0 0 0 0 0	0 0 0 0 0
D O U T 4 4 *	0 0 0 0 0	0 0 0 0 0	0 0 0 0 0
D O U T 4 6 *	0 0 0 0 0		

ON	OFF	DIN	DOUT	SYS
-----------	------------	------------	-------------	------------

- The I/O signal status is represented by "1" for open contacts and by "0" for close contacts.
- One line contains 20 signals which are separated at every 5 signals, and the number of the signal at the head of the signal string is displayed at the left end of the line.
- The number of signals is 64.
- For the page where [ON] or [OFF] is displayed, data indicated by the cursor can be set ON or OFF.

③ SYS (System)

Page 1 (HAND)

I / O	M o n i t o r	(H a n d)	1 / 4
	1	5	8
D O U T 2 0 *	0 0 0 0 0	0 0 0	
D I N 2 0 *	0 0 0 0 0	0 0 0	

ON	OFF	DIN	DOUT	SYS
-----------	------------	------------	-------------	------------

- The I/O signal status is represented by "1" for open contacts and by "0" for close contacts.
- The number of signals is 8 each for input and output, and the number of the signal at the head of the signal string is displayed at the left end of the line.
- For the output signals, data indicated by the cursor (i.e. data inversely displayed) can be set ON or OFF using the corresponding function key.

Page 2 (SYSTEM IN)

I / O Monitor (SYSTEM IN)			2 / 4
0 : STORBE	0 : ALM_RST	1 : STOP	
0 : PRG_RST	0 : RUN	0 : CYCLE	
0 : STEP_RST	0 : EXT_SVON	0 : LOW_SPD	
0 : CYC_RST		1 : BREAK	
0 : DO_RST		0 : SVOFF	
<div style="display: flex; justify-content: space-around; margin-top: 10px;"> DIN DOUT SYS </div>			

Page 3 (SYSTEM OUT)

I / O Monitor (SYSTEM OUT)			3 / 4
0 : EMG_ST	0 : EXTSIG	0 : LOW_ST	
0 : SV_RDY	0 : EXTHOST	0 : BT_ALM	
0 : ACK	0 : SYS_RDY	0 : ALARM	
0 : TEACH	0 : AUTORUN		
0 : INI	0 : CYC_END		
<div style="display: flex; justify-content: space-around; margin-top: 10px;"> DIN DOUT SYS </div>			

Page 4 ① (MOTOR BRAKE CONTROL)

MOTOR BRAKE CONTROL				4 / 4
Axis 1 :	LOCK	Axis 5 :	LOCK	
Axis 2 :	LOCK	Axis 6 :	LOCK	
Axis 3 :	LOCK			
Axis 4 :	LOCK			
<div style="display: flex; justify-content: space-around; margin-top: 10px;"> DIN DOUT SYS </div>				

You cannot edit data on this display.

Page 4 ② (MOTOR BRAKE CONTROL)

MOTOR BRAKE CONTROL				4 / 4
Axis 1 :	FREE	Axis 5 :	LOCK	
Axis 2 :	LOCK	Axis 6 :	LOCK	
Axis 3 :	LOCK			
Axis 4 :	LOCK			
<div style="display: flex; justify-content: space-around; margin-top: 10px;"> LOCK FREE DIN DOUT SYS </div>				

- The display that can be edited can be selected by grasping the TEACHING mode, all-axis brake locking mode, servo OFF status, ENABLE switch.
- The motor brake at each axis can be edited on this display.
- The motor brake at the axis specified in [LOCK] mode is locked.
- The motor brake at the axis specified in [FREE] mode is released.

(3) Cautions

- The edited motor brake information is enabled when the [MOTOR BRAKE CONTROL screen] is displayed and the conditions are satisfied.
- When exiting the [MOTOR BRAKE CONTROL screen], the motor brakes of each axis are locked when the servo is turned off.
- When the servo is turned on, the motor brake is applied for the current axes.

10.4 Current Position Display [POS]

(1) Function

Displays the robot position in the joint, world or work coordinate system.

(2) Procedures

(a) Step 1: Command selection.

Press the NEXT key repeatedly until [POS] is displayed in the menu. Press the corresponding function key, and the following joint coordinate system position display appears.

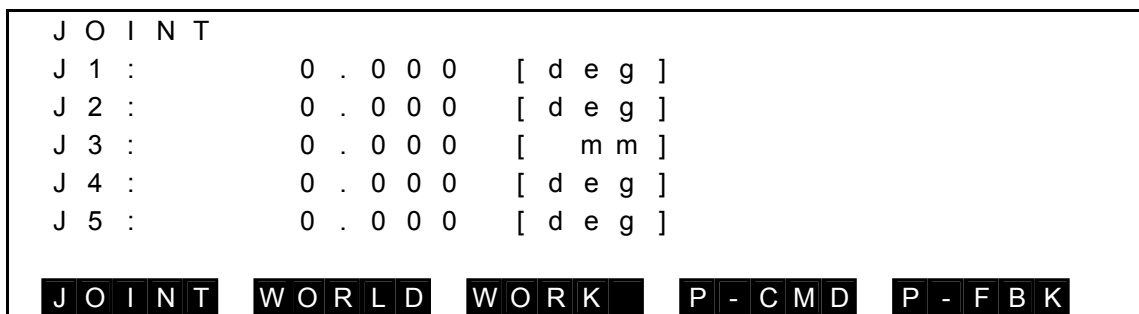

- Coordinate value of respective joints are displayed.

The key operative in this mode and its operation are shown below.

Key	Descriptions
[ESC]	Used to return the system to the utility display.

Operations of each menu are shown below.

Menu	Descriptions
[JOINT]	Used to call the position display in the joint coordinate system.
[WORLD]	Used to call the position display in the world coordinate system.
[WORK]	Used to call the position display in the work coordinate system.
[P-CMD]	Used to call the position command display.
[P-FBK]	Used to call the position feedback display.

(b) Step 2: Change of display.

Press the soft key corresponding to the coordinate system you wish to display, and the position display in the selected coordinate system appears as shown below.

Position display in joint coordinate system

```

J O I N T
J 1 :      0 . 0 0 0   [ d e g ]
J 2 :      0 . 0 0 0   [ d e g ]
J 3 :      0 . 0 0 0   [   m m ]
J 4 :      0 . 0 0 0   [ d e g ]
J 5 :      0 . 0 0 0   [ d e g ]

J O I N T   W O R L D   W O R K   P - C M D   P - F B K
    
```

- Coordinates of respective joints are displayed.

Position display in world coordinate system

```

W O R L D
X :      0 . 0 0 0           W O R K : . w o r l d
Y :      0 . 0 0 0           T O O L :
Z :      0 . 0 0 0           B A S E : . w o r l d
C :      0 . 0 0 0
T :      0 . 0 0 0

J O I N T   W O R L D   W O R K   P - C M D   P - F B K
    
```

- A work coordinate of each axis is displayed.
- When confirming each coordinate name selected as WORK, TOOL, and BASE coordinate systems, COORD is selected.

Position display in work coordinate system

W O R K			
X :	0 . 0 0 0	W O R K :	. w o r l d
Y :	0 . 0 0 0	T O O L :	
Z :	0 . 0 0 0	B A S E :	. w o r l d
C :	0 . 0 0 0		
T :	0 . 0 0 0		
JOINT		WORLD	WORK
P - CMD		P - FBK	

- A work coordinate of each axis is displayed.
- When confirming each coordinate name selected as WORK, TOOL, and BASE coordinate systems, COORD is selected.

Position command display

P O S I T I O N		C O M M A N D	
E 1 :	0		
E 2 :	0		
E 3 :	0		
E 4 :	0		
E 5 :	0		
JOINT		WORLD	WORK
P - CMD		P - FBK	

- Values of position command from each axis servo are displayed.

Position feedback display

P O S I T I O N		F E E D B A C K	
E 1 :	0	E 6 :	0
E 2 :	0	E 7 :	0
E 3 :	0	E 8 :	0
E 4 :	0		
E 5 :	0		
JOINT		WORLD	WORK
P - CMD		P - FBK	

- Values of position feedback from each axis servo are displayed.

(3) Caution

Current position display is also possible even during the automatic operation.

10.5 Selecting Work/Tool Coordinate System [TRANS]

(1) Function

Selects the work coordinate system or tool coordinate system.

(2) Procedures

(a) Step 1: Command selection.

Press the NEXT key repeatedly until [TRANS] is displayed in the menu.

Press the corresponding function key, and the following coordinate data directory display appears.

T R A N S										S E L E C T I O N										[1 /					1 1]				
. w o r l d																									1 0									
T R A N S										0 0 0 0										1					0									
T R A N S										0 0 0 0										2					5									
T R A N S										0 0 0 0										3					0									
↓ T R A N S										0 0 0 0										4					4									
. w o r l d																																		
E N D										F U L L										F I N D					W O R K					T O O L				

- When the program is not selected, the TRANS key becomes invalid.
- The coordinate in which the coordinate data directory is displayed is a coordinate which is defined in the selected program.
- The defined coordinate data are displayed by every one data in the line.
- An inversely displayed section in the data is called the "main cursor" which indicates that this data is selected for editing.
- Symbol "↑" shown in the 1st column signifies that there is coordinate data before the top data.
- Symbol "↓" shown in the 1st column signifies that there is coordinate data after the final data.
- Alphabet "t" displayed in the 1st column represents that the coordinate data on the same line is based on the tool coordinate system.
- Alphabet "w" displayed in the 1st column represents that the coordinate data on the same line is based on the work coordinate system.
- On the right side of the coordinate name, the number of positional data belonging to that coordinate is displayed.
- Regarding the data of [nnnn/mmmm] on the 1st line, "nnnn" identifies the selected coordinate index, and "mmmm" the number of coordinate data.

Keys operative in this mode and their operations are shown below.

Key	Descriptions
↑	Used to move the main cursor up. If the main cursor is located on the top line of screen, the screen scrolls down.
↓	Used to move the main cursor down. If the main cursor is located on the last line of screen, the screen scrolls up.
[ALT] + ↑	Used to move the main cursor up on the screen basis.
[ALT] + ↓	Used to move the main cursor down on the screen basis.
[ESC]	Used to quit coordinate selection and return to the utility screen.

Operations of each menu are shown below.

Menu	Descriptions
[END]	Used to quit coordinate selection and return to the utility screen.
[FULL]	Used to select the detailed display indicated by the main cursor.
[WORK]	Used to specify the coordinate indicated by the cursor in the work coordinate system and cancel the designation.
[TOOL]	Used to specify the coordinate indicated by the cursor in the tool coordinate system and cancel the designation.
[FIND]	Used to search a coordinate name.

10.5.1 Finishing Coordinate System Selection [END]

(1) Function

Finishes the selection of a coordinate system and returns the system to the utility screen.

(2) Procedures

(a) Step 1: Command selection.

The coordinate data directory screen is displayed as shown below.

T R A N S S E L E C T I O N										[1	/	1 1]
. w o r l d														1 0
	T	R	A	N	S	0	0	0	0	1				0
	T	R	A	N	S	0	0	0	0	2				5
	T	R	A	N	S	0	0	0	0	3				0
↓	T	R	A	N	S	0	0	0	0	4				4
. w o r l d														
E N D		F U L L			F I N D			W O R K			T O O L			

Press the [END] key and the following detailed display is called.

R O B O T U T I L I T Y															
A U X			I / O			P O S			T R A N S			W K - T M			>

(3) Caution

When pressing the ESC key, the same display as the above is called.

10.5.2 Detailed Coordinate Data Display [FULL]

(1) Function

Displays the detailed coordinate data display.

(2) Procedures

Assume that you are going to display "TRANS00002" in detail.

(a) Step 1: Command selection.

Move the main cursor to "TRANS00002", and the following display is called.

T R A N S	S E L E C T I O N	[3 /	1 1]
. w o r l d			1 0	
T R A N S 0 0 0 0 1			0	
T R A N S 0 0 0 0 2			5	
T R A N S 0 0 0 0 3			0	
↓ T R A N S 0 0 0 0 4			4	
T R A N S 0 0 0 0 2				
END	FULL	FIND	WORK	TOOL

- For [nnnn/mmmm] in the first column, nnnn signifies the number of positional data belonging to a selected coordinate system. mmmm signifies the total number of positional data in all coordinate systems.

Press the [FULL] key, and the following display is called.

T R A N S 0 0 0 0 2	[3 /	1 1]
X :	5 0 0 . 0 0 0		
Y :	0 . 0 0 0		
Z :	0 . 0 0 0		
C :	0 . 0 0 0		
T R A N S 0 0 0 0 2			
END	DIR	FIND	WORK
			TOOL

Operations of each menu are shown below.

Menu	Descriptions
[END]	Used to quit coordinate selection and to return to the utility display.
[DIR]	Used to select coordinate data directory display.
[WORK]	Used to specify the coordinate system displayed to the work coordinate system and cancel the designation.
[TOOL]	Used to specify the coordinate system displayed to the tool coordinate system and cancel the designation.
[FIND]	Used to search a coordinate name.

(3) Cautions

- The world coordinate system cannot be displayed in detail.
- Each menu, END, WORK, TOOL, FIND is process in the same manner as for the directory display.

10.5.3 Setting Work Coordinate System [WORK]

(1) Function

Sets a specified coordinate in the work coordinate system. When this operation is done for the coordinate already set in the work coordinate system, setting of the work coordinate system is canceled.

(2) Procedures

Assume that you are going to set "TRANS00002" in the work coordinate system.

(a) Step 1: Command selection.

Move the main cursor to "TRANS00002", and the following display is called.

T R A N S S E L E C T I O N										[3 /		1 1]	
. w o r l d												1 0			
T R A N S 0 0 0 0 1												0			
T R A N S 0 0 0 0 2												5			
T R A N S 0 0 0 0 3												0			
↓ T R A N S 0 0 0 0 4												4			
T R A N S 0 0 0 0 2															
E N D			F U L L			F I N D			W O R K			T O O L			

Press the [WORK] key. The data of "TRANS00002" is set as the work coordinate. Alphabet "w" is displayed in the first column, which shows the data has already been set as the work coordinate system.

T R A N S S E L E C T I O N										[3 /		1 1]		
. w o r l d												1 0				
T R A N S 0 0 0 0 1												0				
w	T R A N S 0 0 0 0 2												5			
T R A N S 0 0 0 0 3												0				
↓ T R A N S 0 0 0 0 4												4				
T R A N S 0 0 0 0 2																
E N D			F U L L			F I N D			W O R K			T O O L				

(3) Cautions

- When this operation is done for the world coordinate system, setting of the work coordinate system is canceled.
- When this operation is done for the coordinate already set in the work coordinate system, setting of the work coordinate system is canceled.
- When another coordinate system was set as the work coordinate system, the previous coordinate system is canceled.
- A coordinate system set as the work coordinate is identified by "w" is displayed in the first column of the directory display.

10.5.4 Setting and Canceling of the Tool Coordinate System [TOOL]

(1) Function

Sets a specified coordinate in the tool coordinate system. If this operation is done for a coordinate already set as the tool coordinate, setting of the tool coordinate system is canceled.

(2) Procedures

Assume that you are going to set "TRANS00003" in the tool coordinate system.

(a) Step 1: Command selection.

Move the main cursor to "TRANS00003", and the following display appears.

T R A N S S E L E C T I O N										[4 /	1 1]												
	.	w	o	r	l	d					1	0												
	T	R	A	N	S	0	0	0	0	1		0												
w	T	R	A	N	S	0	0	0	0	2		5												
	T	R	A	N	S	0	0	0	0	3		0												
↓	T	R	A	N	S	0	0	0	0	4		4												
T R A N S 0 0 0 0 3																								
	E	N	D		F	U	L	L		F	I	N	D		W	O	R	K		T	O	O	L	

Press [TOOL], and the data of "TRANS00003" is set in the tool coordinate system and the following display appears.

T R A N S S E L E C T I O N										[4 /	1 1]												
	.	w	o	r	l	d					1	0												
	T	R	A	N	S	0	0	0	0	1		0												
w	T	R	A	N	S	0	0	0	0	2		5												
t	T	R	A	N	S	0	0	0	0	3		0												
↓	T	R	A	N	S	0	0	0	0	4		4												
T R A N S 0 0 0 0 2																								
	E	N	D		F	U	L	L		F	I	N	D		W	O	R	K		T	O	O	L	

(3) Cautions

- When this operation is done for the world coordinate system, setting of the tool coordinate system is canceled.
- When this operation is done for the coordinate system already set as the tool coordinate system, setting of the tool coordinate system is canceled.
- If another coordinate was already set as the tool coordinate, it is canceled by this function.
- A coordinate set as the tool coordinate is identified by "t" in the 1st column of the display.

10.5.5 Search of Coordinate Data [FIND]

(1) Function

Searches the data bearing the specified coordinate name.

(2) Procedures

Assume that you are going to search the coordinate data named "TRANS00008."

(a) Step 1: Command selection.

Assume that the display is as following.

T R A N S										S E L E C T I O N										[1 /		1 1]	
. w o r l d																				1 0					
T R A N S 0 0 0 0 1																				0					
T R A N S 0 0 0 0 2																				5					
T R A N S 0 0 0 0 3																				0					
↓ T R A N S 0 0 0 0 4																				4					
. w o r l d																									
E N D										F U L L										F I N D		W O R K		T O O L	

Press [FIND], and the following display appears.

T R A N S										S E L E C T I O N										[1 /		1 1]	
. w o r l d																				1 0					
T R A N S 0 0 0 0 1																				0					
T R A N S 0 0 0 0 2																				5					
T R A N S 0 0 0 0 3																				0					
↓ T R A N S 0 0 0 0 4																				4					
F I N D : _																									

(b) Step 2: Data name input.

Enter "TRANS00008", and the display is changed over as shown below.

T R A N S										S E L E C T I O N										[1 /		1 1]	
. w o r l d																				1 0					
T R A N S 0 0 0 0 1																				0					
T R A N S 0 0 0 0 2																				5					
T R A N S 0 0 0 0 3																				0					
↓ T R A N S 0 0 0 0 4																				4					
F I N D : T R A N S 0 0 0 0 8 _																									

Keys operative in this mode and their operations are shown below.

Key	Descriptions
←	Used to move the cursor left on the command line.
→	Used to move the cursor right on the command line.
Numeral Alphabet	Used to input characters on the command line.
EXE	Used to search the specified position name and return the system to the coordinate data directory display. Unless the specified data is present, a message saying "Not found" is displayed on the command line.
INS	Used to select the insert or replace mode for the command line.
BS	Used to delete one (1) character just before the cursor position on the command line.
ALT+BS	Used to delete one (1) character at the cursor position on the command line.
ESC	This function works in a different manner according to the presence or absence of input character(s). Presence of input character(s): All input character(s) on the command line are cleared. Absence of input character(s): The system returns to the coordinate data directory display.

Press the EXE key, and search for the specified name. If found, the coordinate data directory is displayed with the specified data at the head of the screen and the main cursor moved there. The display is as shown below.

T R A N S	S E L E C T I O N	[9 /	1 1]
T R A N S 0 0 0 0 8			1 0	
T R A N S 0 0 0 0 9			1 0	
T R A N S 0 0 0 1 0			6	
T R A N S 0 0 0 0 8				
E N D	F U L L	F I N D	W O R K	T O O L

(3) Cautions

- If the search data exist in the search start display, the main cursor simply moves to the data position, and the data is not displayed at the head of the screen.
- Unless the specified name exists, the system returns to the previous directory display with a message of "NOT FOUND" shown on the command line.
- As the search is performed throughout the file, the search start position is unrelated to the search operation.

10.5.6 Coordinate Data Directory Display [DIR]

(1) Function

Calls the coordinate data directory display.

(2) Procedures

(a) Step 1: Command selection.

Assume that you are going to display the data of "TRANS00002" in detail.

T R A N S 0 0 0 0 2										[3 / 1 1]	
X :	5	0	0	.	0	0	0				
Y :		0	.	0	0	0					
Z :		0	.	0	0	0					
C :		0	.	0	0	0					
T R A N S 0 0 0 0 2											
E N D		D I R		F I N D		W O R K		T O O L			

Press [DIR], and the following load data directory display appears.

T R A N S										S E L E C T I O N		[3 / 1 1]	
.	w	o	r	l	d						1 0		
T	R	A	N	S	0	0	0	0	1		0		
T	R	A	N	S	0	0	0	0	2		5		
T	R	A	N	S	0	0	0	0	3		0		
↓	T	R	A	N	S	0	0	0	4		4		
T R A N S 0 0 0 0 2													
E N D		F U L L		F I N D		W O R K		T O O L					

(3) Caution

The position of the main cursor in the directory display coincides with the position of the coordinate displayed in detail.

10.6 Working Time Display [WK-TM]

- (1) Function
Displays the robot working time.
- (2) Procedures
 - (a) Step 1: Command selection.
Press the NEXT key repeatedly until [WK-TM] is displayed in the menu.
Press the [WK-TM] key, and the following working time display appears.

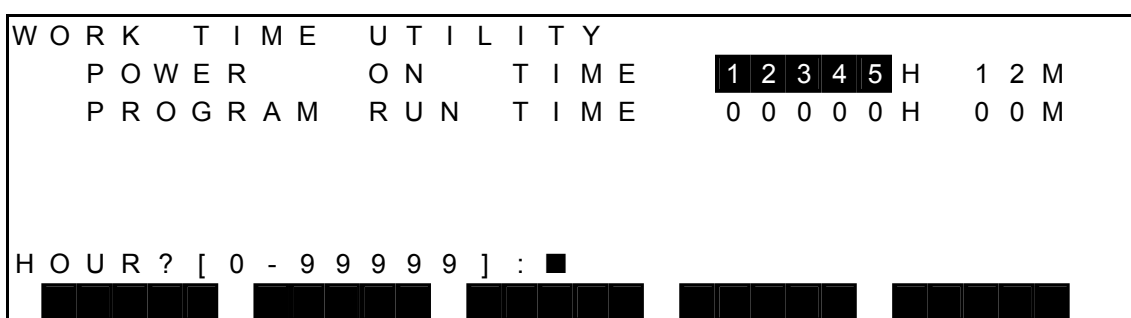

- "POWER ON TIME" displays the total power ON time in hours and minutes (H M).
- "PROGRAM RUN TIME" indicates the total program run time in hours and minutes (H M).
- Each time can be changed in this mode.

Keys operative in this mode and their operations are shown below.

Key	Descriptions
↑	Used to move the cursor up. The command line is cleared.
↓	Used to move the cursor down. The command line is cleared.
←	Used to move the cursor to the left. The command line is cleared.
→	Used to move the cursor to the right. The command line is cleared.
Numeral	Used to input characters on the command line.
EXE	Used to change the data indicated by main the cursor to the input value.
BS	Used to delete one (1) character just before the cursor position on the command line.
ALT+BS	Used to delete one (1) character at the cursor position on the command line.
ESC	Used to return the system to the utility display.

(b) Step 2: Data input.

Move the main cursor to a data you wish to change, and enter a new data. Character input to the command line is always effective.

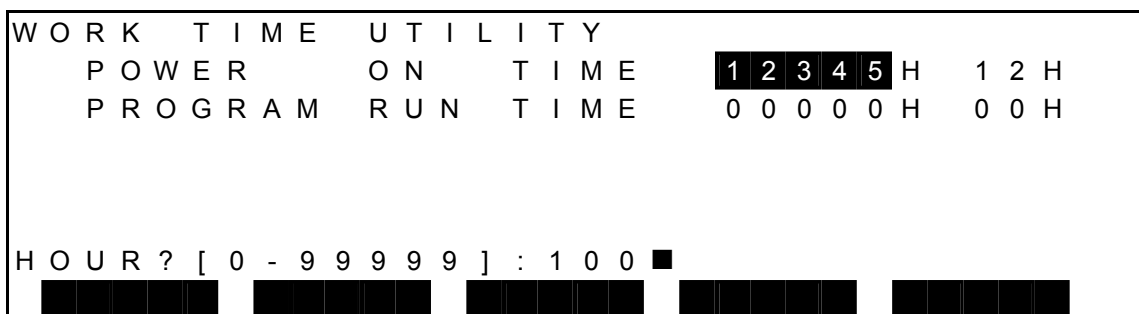

Press the EXE key, and the value indicated by the main cursor is replaced with the new value you entered. The display is as shown below.

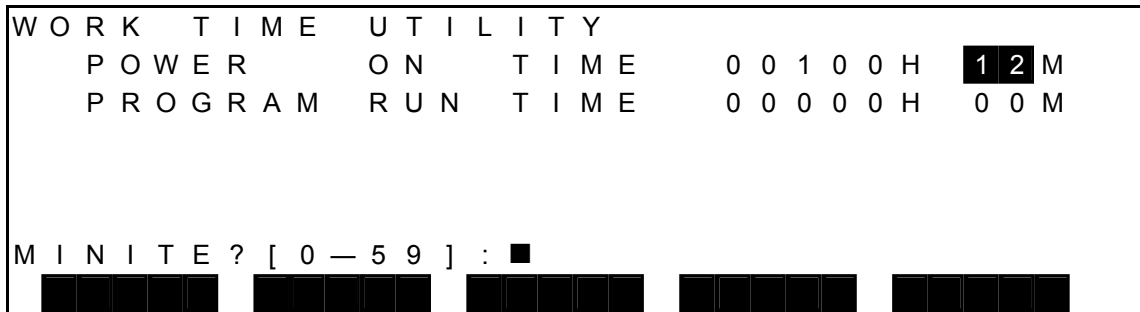

(3) Caution

The input range of each data is as follows:

- Hour : 0 ~ 99999
- Minute : 0 ~ 59

10.7 Reproducing the Origin [REORG]

- (1) Function
Reproduces the origin.
- (2) Procedures
 - (a) Step 1: Command selection.
Set the servo OFF.
Press the NEXT key repeatedly until [REORG] is displayed in the menu.
Press the [REORG] key, and the following origin reproduction display appears.

[Page 1]

U S E R	H O M E 1	H O M E 2	
(J 1)	- 9 9 9 9 9 9 9 9	- 9 9 9 9 9 9 9 9	[d e g]
(J 2)	0	0	[d e g]
(J 3)	0	0	[m m]
(J 4)	0	0	[d e g]
(J 5)	0	0	[m m]
S E T		T E A C H	

[Page 2]

S Y S T E M	H O M E 3	H O M E 4	
(J 1)	- 9 9 9 9 9 9 9 9	- 9 9 9 9 9 9 9 9	[d e g]
(J 2)	0	0	[d e g]
(J 3)	0	0	[m m]
(J 4)	0	0	[d e g]
(J 5)	0	0	[m m]
S E T		T E A C H	

- The origin coordinate of each axis is displayed.
- The origin coordinate as specified by the ZEROP function can be set on the display, using the [TEACH] function.
- The [SET] function works in the same manner as the ZEROP function.

- This function is intended for reproducing the machine origin. DO NOT use it at other than origin reproduction.

(3) Caution

For details of the display contents and setting, see the Maintenance Manual.

10.8 Joint Limit Setting [J-LIM]

- (1) Function
Displays joint limit set values and sets a joint limit value as necessary.
- (2) Procedures
 - (a) Step 1: Command selection.
Press the NEXT key repeatedly until [J-LMT] is displayed in the menu.
Press the [J-LIM] key, and the following joint limit set value display appears.

	[-] L I M I T		[+] L I M I T
J 1 :	- 1 1 0 . 0 0 0		1 1 0 . 0 0 0 [d e g]
J 2 :	- 1 3 7 . 0 0 0		1 3 7 . 0 0 0 [d e g]
J 3 :	0 . 0 0 0		2 0 0 . 5 0 0 [m m]
J 4 :	- 2 8 0 . 0 0 0		2 8 0 . 0 0 0 [d e g]
J 5 :	0 . 0 0 0		0 . 0 0 0 [d e g]

Both minus (-) and plus (+) limit coordinates of each joint are displayed.

Keys operative in this mode and their operations are shown below.

Key	Descriptions
↑	Used to move the main cursor up. If it is located at the top, the cursor will not move at all.
↓	Used to move the main cursor down. If it is located at the bottom, the cursor will not move at all.
→	Used to move the cursor to the right. If it is located on the right end, the cursor will not move at all.
←	Used to move the main cursor to the left. If it is located on the left end, the cursor will not move at all.
[EXE]	Used to change the data indicated by the main cursor.
[ESC]	Used to return the system to the utility display.

(b) Step 2: Data input.

Move the main cursor to a data you wish to change, using the cursor keys (\rightarrow , \leftarrow , \uparrow , \downarrow), and press the EXE key. Now, the current data is displayed on the command line. The display is changed over as shown below.

```

[ - ] L I M I T           [ + ] L I M I T
J 1 : - 1 1 0 . 0 0 0     1 1 0 . 0 0 0 [ d e g ]
J 2 : - 1 3 7 . 0 0 0     1 3 7 . 0 0 0 [ d e g ]
J 3 :           0 . 0 0 0     2 0 0 . 5 0 0 [ m m ]
J 4 : - 2 8 0 . 0 0 0     2 8 0 . 0 0 0 [ d e g ]
J 5 :           0 . 0 0 0         0 . 0 0 0 [ d e g ]
: - 1 1 0 . 0 0 0 █

```

Enter the data to be changed, and the following display appears.

```

[ - ] L I M I T           [ + ] L I M I T
J 1 : - 1 1 0 . 0 0 0     1 1 0 . 0 0 0 [ d e g ]
J 2 : - 1 3 7 . 0 0 0     1 3 7 . 0 0 0 [ d e g ]
J 3 :           0 . 0 0 0     2 0 0 . 5 0 0 [ m m ]
J 4 : - 2 8 0 . 0 0 0     2 8 0 . 0 0 0 [ d e g ]
J 5 :           0 . 0 0 0         0 . 0 0 0 [ d e g ]
: - 9 0 . 0 0 0 █

```

Keys operative in this mode and their operations are shown below.

Key	Descriptions
<p>Numeral</p> <p>. + -</p>	Used to input characters on the command line.
EXE	Used to change a data indicated by the cursor to an entered one. The system returns to the joint limit display.
INS	Used to select the insert or replace mode for the command line.
BS	Used to delete one (1) character just before the cursor position on the command line.
ALT + BS	Used to delete one (1) character at the cursor position on the command line.
ESC	<p>This function works in a different manner according to the presence or absence of input character(s).</p> <p>Presence of input character(s): All input character(s) on the command line are cleared.</p> <p>Absence of input character(s): The system returns to the joint limit display.</p>

Press the EXE key, and the data at the cursor position is changed. The display is changed over as shown below.

	[-] L I M I T	[+] L I M I T	
J 1 :	- 9 0 . 0 0 0	1 1 0 . 0 0 0	[d e g]
J 2 :	- 1 3 7 . 0 0 0	1 3 7 . 0 0 0	[d e g]
J 3 :	0 . 0 0 0	2 0 0 . 5 0 0	[m m]
J 4 :	- 2 8 0 . 0 0 0	2 8 0 . 0 0 0	[d e g]
J 5 :	0 . 0 0 0	0 . 0 0 0	[d e g]

(3) Cautions

- The rotary joint is input in units of degree (°) and the linear joint in units of mm.
- These limit values are used to limit the automatic operation range and teaching range of the robot for each joint. They are factory-set to the maximum working range for each axis.
- Each joint set values are registered in the user parameter file (file name: USER. PAR). If any set value has been changed, relevant data in the user parameter file in the RAM drive is also updated automatically.

10.9 Date and Time Setting [DATE]

- (1) Function
Displays and sets current date and time.
- (2) Procedures
 - (a) Step 1: Command selection.
Press the NEXT key repeatedly until [DATE] is displayed in the menu. Press the [DATE] key, and the following date and time setting display appears.

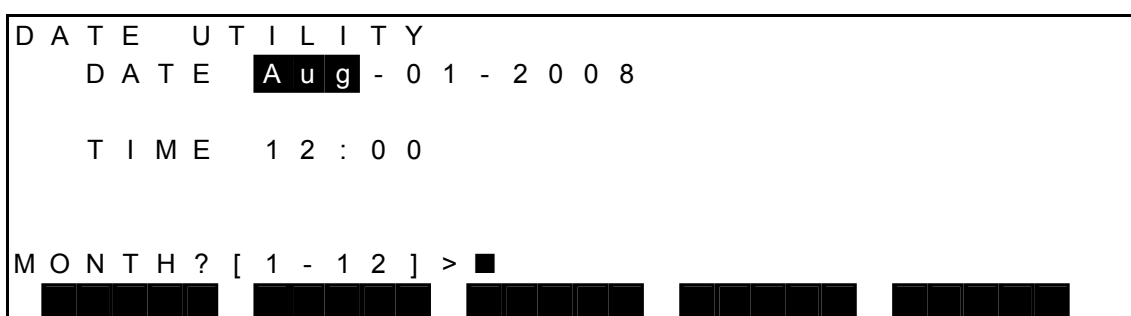

- "DATE" displays the current date by "month–day–year."
- "TIME" indicates the current time in hours and minutes.

Keys operative in this mode and their operations are shown below.

Key	Descriptions
↑	Used to move the main cursor up. The command line is cleared.
↓	Used to move the main cursor down. The command line is cleared.
←	Used to move the main cursor to the left. The command line is cleared.
→	Used to move the main cursor to the right. The command line is cleared.
Numeral	Used to input characters on the command line.
EXE	Used to change the data indicated by the main cursor to the input value.
BS	Used to delete one (1) character just before the main cursor position on the command line.
ALT+BS	Used to delete one (1) character at the main cursor position on the command line.
ESC	Used to return the system to the utility display.

(b) Step 2: Data input.

Move the main cursor to a data you wish to change, and enter a new data. Character input to the command line is always effective.

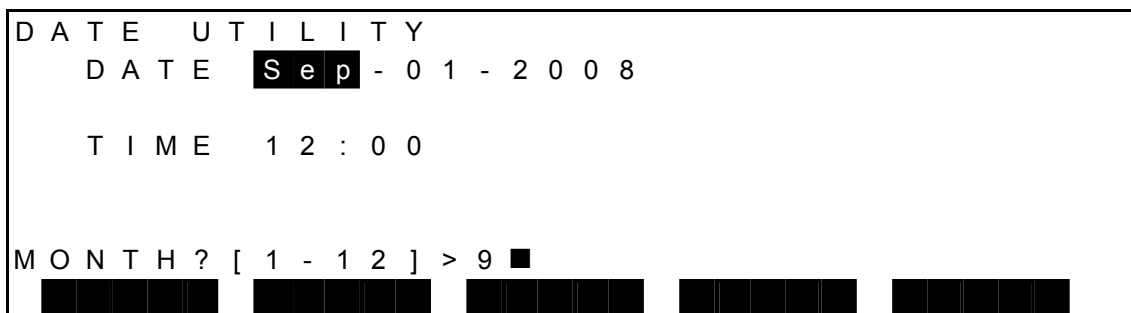

Press the EXE key, and the value indicated by the main cursor is replaced with the new value you entered. The display is as shown below.

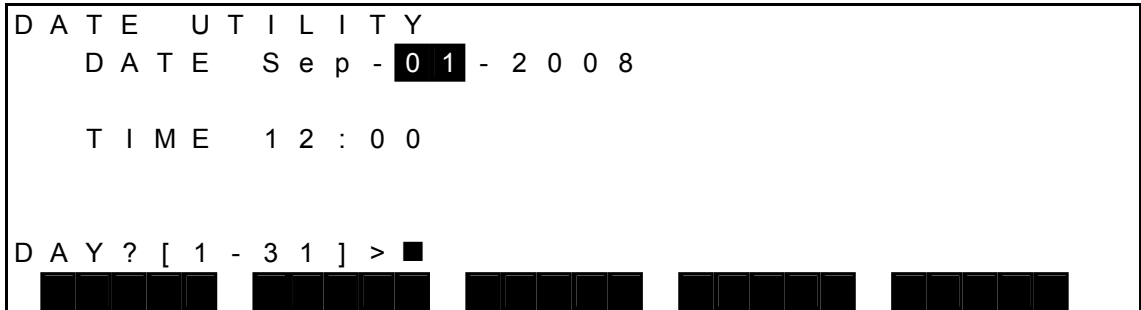

(3) Cautions

- As the controller has a built-in calendar which is backed up by a battery, setting is usually unnecessary. Set the data again only when the date or time is incorrect.

The input range of each data is as follows:

Year : 0 ~ 99 (2000 ~ 2099)
 Month : 1 ~ 12
 Day : 1 ~ 31
 Hour : 0 ~ 23
 Minute : 0 ~ 59

- If only an asterisk (*) mark is input as the data, the display is initialized as shown below. Use this mark if the calendar display is illegal in the initial state.

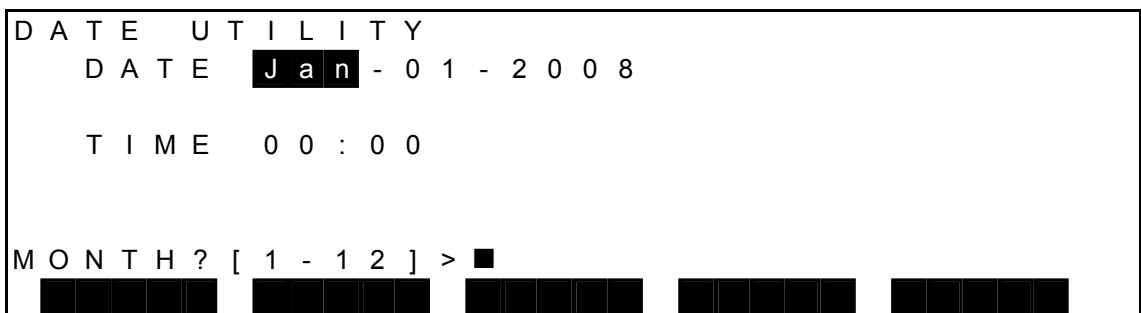

10.10 Version Display [VER]

- (1) Function
Displays the system version.
- (2) Procedures
 - (a) Step 1: Command selection.
Press the NEXT key repeatedly until [VER] is displayed in the menu. Press the [VER] key, and the following version display appears.

```

System version display
SYSTEM VERSION [ 1 / 2 ]
X8LBB - xxx 2008 - 05 - 22 15 : 00 FFFF
X8GCA - xxx 2008 - 05 - 22 15 : 00 FFFF
X8GCC - xxx 2008 - 05 - 22 15 : 00 FFFF
X8GLA - xxx 2008 - 05 - 22 15 : 00 FFFF

SYS ROBOT SEQ AMP
    
```

- The data is displayed in the order of the system version name, date of creation and check sum value from the left.
- The date of creation is shown in the order of "year, month, day, hour and minute."
- A check sum value is expressed in the hexadecimal notation.
- Page 1 contains the versions of boot ROM, main, communication (standard), sequence, communication (option).
- Page 2 contains the version of the servo board.

```

Robot information display
ROBOT INFORMATION
MODEL TH650A - Z200
ROBOT.PAR FHT264 V10.01
SERVO.PAR FHT264 V10.01
MACHINE NO. ??????
CONTROL NO. ??????

SYS ROBOT SEQ AMP
    
```

- MODEL: Displays the type of the [R01] robot specified in ROBOT.PAR.

- **ROBOT. PAR:** Displays [R02] FHT number and [R03] FHT version specified in ROBOT. PAR.
- **SERVO. PAR:** Displays [S02] FHT number and [S03] FHT version specified in SERVO. PAR.
- **MACHINE NO.:** Displays [M02] robot number specified in MACHINE. PAR.
- **CONTROL NO.:** Displays [M01] controller number specified in MACHINE. PAR.

Sequence information display

S E Q U E N C E I N F O R M A T I O N	
I / O M O D E	D e f a u l t
P R O G R A M N A M E	T S 3 K S E Q 0 1
C O M M O N	T Y P E - N
F I E L D B U S	P R O F I B U S

S Y S	R O B O T	S E Q	A M P				
-------	-----------	-------	-------	--	--	--	--

- **I/O MODE:** Displays [U11] startup sequence specified in USER. PAR.
- **PROGRAM NAME:** Displays a sequence file name during run.
- **COMMON:** Displays "TYPE-N" or "TYPE-P" viewing the flag.
- **FIELDBUS:** Displays the name of the FIELDBUS board mounted on the robot controller.

Servo amplifier information display

S E R V O A M P I N F O R M A T I O N			
A - s l o t	A x i s 1	E x t 1	N o n e
B - s l o t	A x i s 2	E x t 2	N o n e
C - s l o t	A x i s 3	E x t 3	N o n e
D - s l o t	A x i s 4	E x t 4	A x i s 1
E - s l o t	N o n e		
F - s l o t	N o n e		

S Y S	R O B O T	S E Q	A M P				
-------	-----------	-------	-------	--	--	--	--

- **slot:** Displays the axis-setting rotary SW on the slot A.
- **slot:** Displays the axis-setting rotary SW on the slot B.
- **slot:** Displays the axis-setting rotary SW on the slot C.
- **slot:** Displays the axis-setting rotary SW on the slot D.
- **slot:** Displays the axis-setting rotary SW on the slot E.
- **slot:** Displays the axis-setting rotary SW on the slot F.

- Ext 1: Displays the axis-setting rotary SW.
- Ext 2: Displays the axis-setting rotary SW.
- Ext 3: Displays the axis-setting rotary SW.
- Ext 4: Displays the axis-setting rotary SW.

Keys operative in this mode and their operations are shown below.

Key	Descriptions
[ALT] + [↓] or [NEXT] or [↓]	Used to display the next page. If the cursor is located at the final page, the top page is selected.
[ALT] + [↑] or [ALT] + [NEXT] or [↑]	Used to display the previous page. If the cursor is located at the top page, the final page is selected.
[ESC]	Used to return the system to the utility display.

Operations of each menu are shown below.

Menu	Descriptions
[SYS]	Displays the system version.
[ROBOT]	Displays information on the robot.
[SEQ]	Displays sequence information.
[AMP]	Displays information on the servo amplifier.

10.11 Servo Encoder Data Display [ENC]

(1) Function

Displays the servo encoder data.

(2) Procedures

(a) Step 1: Command selection.

Press the NEXT key repeatedly until [ENC] is displayed in the menu. Press the [ENC] key, and the following encoder data monitor display appears.

	M U L T I	S I N G L E	E r r - d f	I D
E 1	0	0 0 0 0 0 0 0 0	0 0 0 0	0 0
E 2	0	0 0 0 0 0 0 0 0	0 0 0 0	0 0
E 3	0	0 0 0 0 0 0 0 0	0 0 0 0	0 0
E 4	0	0 0 0 0 0 0 0 0	0 0 0 0	0 0
E 5	0	0 0 0 0 0 0 0 0	0 0 0 0	0 0

E R R O R		R E S E T		
------------------	--	------------------	--	--

Each axis encoder data is displayed.

This function is intended for the maintenance only. To make valid any change in the data, therefore, subsequent input of combined keys is necessary.

The key operative in this mode and its operation are shown below.

Key	Descriptions
ESC	Used to return the system to the utility display.

(3) Caution

For detailed information, refer to the separate instruction manual.

10.12 PLC Monitor [PLC-M]

- (1) Function
Displays the PLC data.
- (2) Procedures
 - (a) Step 1: Command selection.
Press the NEXT key repeatedly until [PLC-M] is displayed in the menu.
Press the [PLC-M] key and the following PLC monitor display appears.
Press the contact menu you wish to display and the display item is changed.
The display contents on each page are as shown below.

• X display

P L C	M o n i t o r (X	P L C - I n p u t)	1 / 4
	F - - - - -	8 7 - - - - -	0
X 0 0 *	0 0 0 0 0 0 0 0	0 0 0 0 0 0 0 0	
X 0 1 *	1 1 0 0 0 0 0 0	0 0 0 0 0 0 0 0	
X 0 2 *	0 0 0 0 0 0 0 0	0 0 0 0 1 0 1 1	
X 0 3 *	0 0 0 0 0 0 0 0	0 0 0 0 0 0 0 0	
X	Y	G	H

• Y display

P L C	M o n i t o r (Y	P L C - o u t p u t)	1 / 4
	F - - - - -	8 7 - - - - -	0
Y 1 0 *	0 0 0 0 0 0 0 0	0 0 0 0 0 0 0 0	
Y 1 1 *	0 0 0 0 0 0 0 0	0 0 0 0 0 0 0 0	
Y 1 2 *	0 0 0 0 0 0 0 0	0 0 0 0 0 0 0 0	
Y 1 3 *	0 0 0 0 0 0 0 0	0 0 0 0 0 0 0 0	
X	Y	G	H

• G display

P L C	M o n i t o r (G	P L C - > R O B O T)	1 / 8
	F - - - - -	8 7 - - - - -	0
G 0 0 *	0 0 0 0 0 0 0 0	0 0 0 0 0 0 0 0	
G 0 1 *	0 0 0 0 0 0 0 0	0 0 0 0 0 0 0 0	
G 0 2 *	0 0 0 0 0 0 0 0	0 0 0 0 0 0 0 0	
G 0 3 *	0 0 0 0 0 0 0 0	0 0 0 0 0 0 0 0	
X	Y	G	H

• H display

P L C	M o n i t o r	(G	R O B O T	- >	P L C)	1 / 8
			F	- - - - -	8	7	- - - - - 0
	H 0 0 *		0	0	0	0	0 0 0 0 0 0 0 0
	H 0 1 *		0	0	0	0	0 0 0 0 0 0 0 0
	H 0 2 *		0	0	0	0	0 0 0 0 0 0 0 0
	H 0 3 *		0	0	0	0	0 0 0 0 0 0 0 0

X	Y	G	H
---	---	---	---

Select [X], [Y], [G], or [H] to display the data on each contact data of the PLC.

Keys operative in this mode and their operations are shown below.

Key	Descriptions
[ALT] + [↓] or [NEXT] or [↓]	Used to display the next page. If the cursor is located at the final page, the top page is selected.
[ALT] + [↑] or [ALT] + [NEXT] or [↑]	Used to display the previous page. If the cursor is located at the top page, the final page is selected.
[ESC]	Used to return the system to the utility display.

Operations of each menu are shown below.

Menu	Descriptions
[X]	Moves to the X display on the PLC monitor.
[Y]	Moves to the Y display on the PLC monitor.
[G]	Moves to the G display on the PLC monitor.
[H]	Moves to the H display on the PLC monitor.

(3) Caution

For detailed information, refer to the separate instruction manual.

10.13 Zero Position Setting [ZEROP]

(1) Function
Sets the zero position (or origin).

(2) Procedures

(a) Step 1: Command selection.

Set the servo OFF.

Press the NEXT key repeatedly until [ZEROP] is displayed in the menu. The following zero position setting display appears.

Z E R O	P O S I T I O N
E 1	- 7 5 0 0 0
E 2	1 5 0 0 0 0 0
E 3	5 3 0 1
E 4	2 1 0 0 0 0
E 5	0

- Zero position of each axis encoder is displayed.
- This function is intended for the maintenance only. To make valid any change in the data, therefore, subsequent input of combined keys is necessary.
- This function is used to establish the machine zero position (or origin). If the operation is done incorrectly, the zero position will shift, causing a very dangerous situation.
- To avoid this, take careful precautions on the use of this function.

(3) Caution

For detailed information, refer to the separate instruction manual.

10.14 Motor Load Display [MOTOR]

(1) Function

Displays the torque, electronic thermal total value and load factor of each servo motor.

(2) Procedures

(a) Step 1: Command selection.

Press the NEXT key repeatedly until [MOTOR] is displayed in the menu.

Press the [MOTOR] key and the following display appears.

T O R Q U E	P E A K	L I M I T
J 1 : 1 0 . 2 %	2 1 0 . 1 %	3 0 0 . 0 %
J 2 : 2 . 1 %	1 8 5 . 7 %	3 0 0 . 0 %
J 3 : 3 4 . 5 %	1 5 5 . 8 %	3 0 0 . 0 %
J 4 : 2 . 5 %	1 2 6 . 0 %	3 0 0 . 0 %
J 5 : 0 . 0 %	0 . 0 %	3 0 0 . 0 %

T O R Q U	T H E R M	L O A D							
-----------	-----------	---------	--	--	--	--	--	--	--

The key operative in this mode and its operation are shown below.

Key	Descriptions
ESC	Used to return the system to the utility display.

Operations of each command menu are shown below.

Menu	Descriptions
[TORQU]	Used to display the torque value of each motor.
[THERM]	Used to display the electronic thermal total value of each motor.
[LOAD]	Used to display the load factor of each motor.

(b) Step 2: Change of display.

Press the command menu for the coordinates you wish to display. Then the following position display of each coordinate system appears.

Torque display

T O R Q U E	P E A K	L I M I T
J 1 : 1 0 . 2 %	2 1 0 . 1 %	3 0 0 . 0 %
J 2 : 2 . 1 %	1 8 5 . 7 %	3 0 0 . 0 %
J 3 : 3 4 . 5 %	1 5 5 . 8 %	3 0 0 . 0 %
J 4 : 2 . 5 %	1 2 6 . 0 %	3 0 0 . 0 %
J 5 : 0 . 0 %	0 . 0 %	3 0 0 . 0 %

T O R Q U	T H E R M	L O A D							
-----------	-----------	---------	--	--	--	--	--	--	--

- The current motor torque of each axis is displayed.
(100% = Rated torque)
- In the PEAK column, the maximum value from the power ON to the current time is displayed.
- Under the LIMIT column, the ratio of the maximum torque to the rated torque is displayed.

Electronic thermal total value display

T H E R M A L (1 0 0 % = E r r)
J 1 : 1 0 . 2 %
J 2 : 0 . 0 %
J 3 : 0 . 0 %
J 4 : 2 . 5 %
J 5 : 0 . 0 %

T O R Q U	T H E R M	L O A D							
-----------	-----------	---------	--	--	--	--	--	--	--

- The current total value of the electronic thermal is displayed.
- When the value reaches 100%, the alarm of "Axis* Electric Thermal" occurs.

Load factor display

L O A D	1 M i n	1 5 M i n	2 H o u r
J 1 :	5 0 . 2 %	4 5 . 1 %	4 2 . 5 %
J 2 :	3 2 . 1 %	2 8 . 7 %	3 3 . 2 %
J 3 :	2 4 . 5 %	3 4 . 8 %	2 9 . 8 %
J 4 :	2 . 5 %	1 2 . 0 %	1 2 . 1 %
J 5 :	0 . 0 %	0 . 0 %	0 . 0 %

T O R Q U	T H E R M	L O A D							
-----------	-----------	---------	--	--	--	--	--	--	--

- The current motor factor of each axis is displayed.
(100% = Rated load)
- The displayed values are the running averages for the duration of the past one (1) minute, fifteen (15) minutes and two (2) hours.
- When the load factor under the column of "1 Min" or "15 Min" reaches the specified value, the alarm saying "Axis* Motor overload", is generated.

10.15 Ethernet Status Display [ETHER]

(1) Function

Displays the Ethernet status.

ETHER function is provided as standard in TS3000 and as an option in TSL3000.

(2) Procedures

(a) Step 1: Command selection.

Press the NEXT key repeatedly until [ETHER] is displayed in the menu, and then press [ETHER].

The screen shown below is displayed.

```

ETHERNET STATUS [ 1 / 3 ]

IP ADDRESS      1 9 2 . 1 6 8 .    0 . 1 2 4
SUBNET MASK     2 5 5 . 2 5 5 . 2 5 5 .    0
MAC ADDRESS     0 0 0 0 4 8 : 1 4 0 2 0 6
FIRMWARE        S 1 S 6 0 0 0 0 / 0 0 0 1 : 0 0 : 2 0
    
```

(b) Step 2: Display change.

The display items can be changed by pressing ALT key + ↓ key, the NEXT key (or ALT key + ↑ key, ALT key + NEXT key).

The information displayed on each page is shown below.

[Page 1]

```

ETHERNET STATUS [ 1 / 3 ]

IP ADDRESS      1 9 2 . 1 6 8 .    0 . 1 2 4
SUBNET MASK     2 5 5 . 2 5 5 . 2 5 5 .    0
MAC ADDRESS     0 0 0 0 4 8 : 1 4 0 2 0 6
FIRMWARE        S 1 S 6 0 0 0 0 / 0 0 0 1 : 0 0 : 2 0
    
```

- IP ADDRESS: IP address of the robot controller itself that is written in the "ETHERNET. PAR" [E01] file
- SUBNET MASK: Subnet mask of the network that is written in the "ETHERNET. PAR" [E03] file
- MAC ADDRESS: MAC address of the robot controller itself
- FIRMWARE: Version of the Ethernet unit firmware

[Page 2]

E T H E R N E T S T A T U S							[2 / 3]
	O w n P o r t	C o n n e c t	I P		P o r t		
I P 0	1 0 0 0	0 0 0 . 0 0 0 . 0 0 0 . 0 0 0			0 0 0 0 0		
I P 1	0 0 0 0	0 0 0 . 0 0 0 . 0 0 0 . 0 0 0			0 0 0 0 0		
I P 2	0 0 0 0	0 0 0 . 0 0 0 . 0 0 0 . 0 0 0			0 0 0 0 0		
I P 3	0 0 0 0	0 0 0 . 0 0 0 . 0 0 0 . 0 0 0			0 0 0 0 0		

- IP0 to IP3: Ethernet channel number
- OwnPort: Robot port number
- Port: Port number of the other connected device
- Connect IP: IP address of the other connected device

[Page 3]

E T H E R N E T S T A T U S				[3 / 3]
	A p p .	M o d e	S t a t u s	
I P 0	H O S T	T C P / S	L I S E N	
I P 1	S C O L	T C P / C	C L O S E D	
I P 2	S C O L	T C P / S	C L O S E D	
I P 3	S Y S T E M	T C P / S	C L O S E D	

- IP0 to IP3: This indicates the Ethernet channel number.
- App.: Name of application using the channel
The connection in the control status from robot language uses simple protocol when HOST is shown and uses non-protocol communication when SCOL is shown.
- Mode: Protocol type, open status
TCP/S indicates a server connection using TCP protocol, and TCP/C indicates a client connection using TCP protocol.
- Status: Ethernet port status
The statuses below are displayed. For the specific meaning of each status, refer to any commercially available reference that provides explanations of TCP/IP.

Closed	Close wait
Listen	Closing
Syn-Sent	Last ACK
Syn-Received	Time Wait
Established	

Fin-Wait1

Fin-Wait2

(3) Cautions

- Check that the Ethernet cable between the controller and external device is connected correctly.
- Use a cross connect cable if connecting the robot controller directly to the external device, and use a straight cable if the connection passes through a hub.
- After making any parameter settings, turn the power off and then on again to enable the new settings.

10.16 Payload Settings During Manual Guidance [PAYLD]

(1) Function
 Displays the PAYLOAD value during manual guidance and, if necessary, sets the PAYLOAD value during manual guidance.

(2) Procedures

(a) Step 1: Command selection.

Press the NEXT key repeatedly until [PAYLD] is displayed in the menu, and then press [PAYLD].

The PAYLOAD setting screen during manual guidance appears as shown below.



The keys enabled in this mode and their operations are shown in the table below.

Key	Operation description
	Used to move the main cursor up. The cursor does not move when it is at the top edge.
	Used to move the main cursor down. The cursor does not move when it is at the bottom edge.
	Used to change the data of the main cursor position.
	Used to return the system to the utility display.

(b) Step 2: Data input.

Use the ↑ or ↓ key to align the main cursor with the data that will be set, and then press the EXE key.

The current data is displayed in the command line.

The screen appears as shown below.

```
P A Y L O A D   f o r   M a n u a l   O p e r a t i o n
M a s s       ( k g ) :      0 . 0 0 0
O f f s e t   ( m m ) :      0 . 0 0
> 0 . 0 0 0
```

Enter the data that will be changed. The screen appears as shown below.

```
P A Y L O A D   f o r   M a n u a l   O p e r a t i o n
M a s s       ( k g ) :      0 . 0 0 0
O f f s e t   ( m m ) :      0 . 0 0
> 1 0 . 0 0 0
```

The keys enabled in this mode and their operations are shown in the table below.

Key	Operation description
Numeral, \square , \square , \square , \square	Used to enter the characters in the command line.
EXE	Used to change the data at the main cursor position to the entered value. Used to return to the PAYLOAD setting value display screen.
INS	Used to switch between insert/replace mode for the command line.
BS	Used to erase the character just before the command line cursor position.
ALT + BS	Used to erase the character at the command line cursor position.
ESC	Operation varies depending on whether there are entered characters. When characters are entered: All characters entered in the command line are erased. When no characters are entered: Used to return to the PAYLOAD setting value display screen.

Press the EXE key. The data at the cursor position changes. The screen appears as shown below.



(3) Cautions

- The weight of a load is indicated in kg units, and the offset is indicated in mm units.
- The PAYLOAD setting value for manual guidance is stored in the user parameter file (file name: USER. PAR).

If the PAYLOAD setting value for manual guidance is changed, the information in the user parameter file on the RAM drive is also automatically updated.

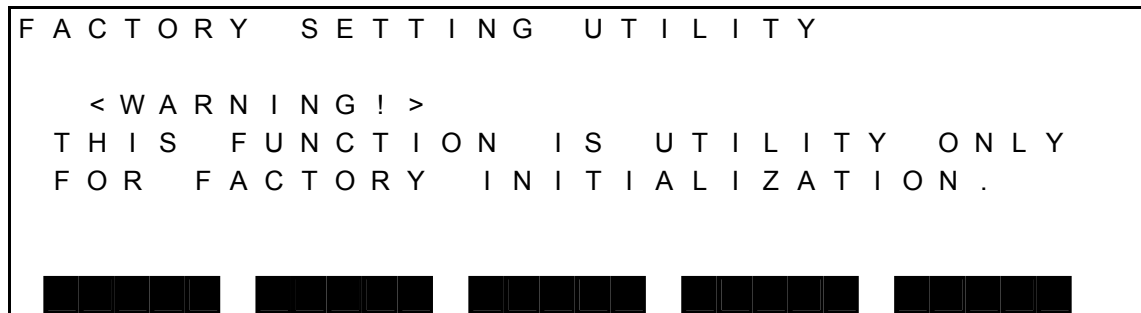
10.17 Initialization to Factory Settings [FCTRY]**(3) Caution**

This screen is used to perform initialization to the factory settings. The user must not use this display.

10.18 RAM Disk Backup [BCKUP]

(1) Function

Backs up the data in the RAM disk to the internal flash memory.
Provides a recovery method if the data in the RAM disk is inadvertently erased or if the RAM disk is damaged due to low battery voltage or other cause.

(2) Procedures

(a) Step 1: Command selection.

Press the NEXT key repeatedly until [BCKUP] is displayed in the menu, and then press [BCKUP].



The BACKUP screen appears as shown below.

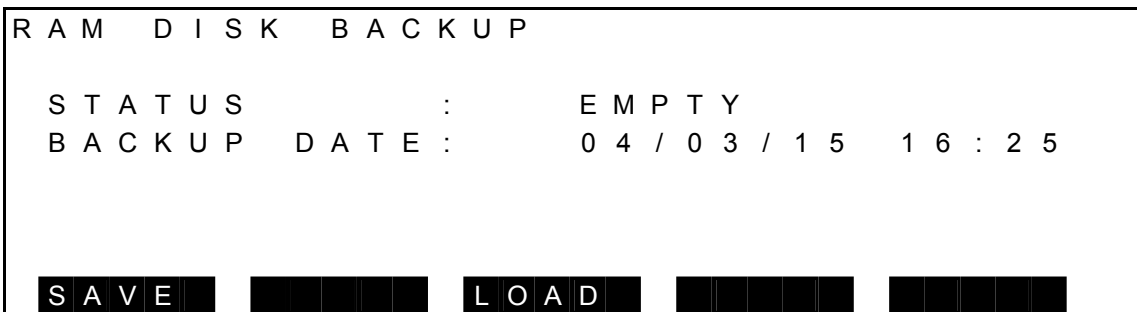

(b) Step 2: Save.

Press the ALT key and the [0] key at the same time to enable the function key.
Press [SAVE], and then press the EXE key.

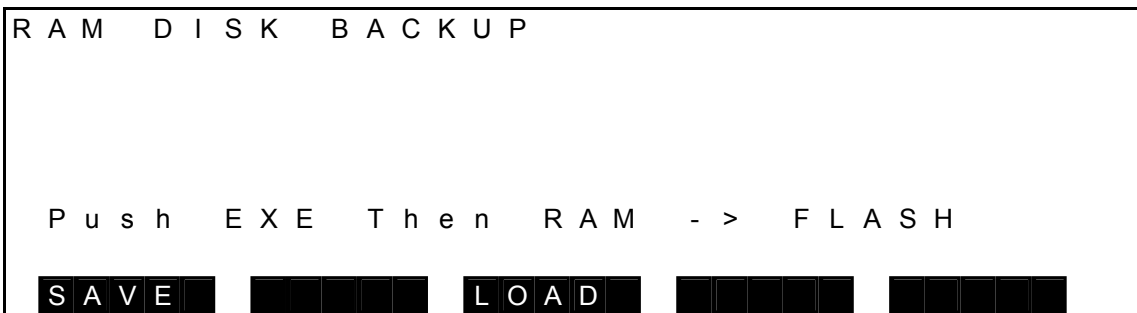

Press the EXE key to start the backup.

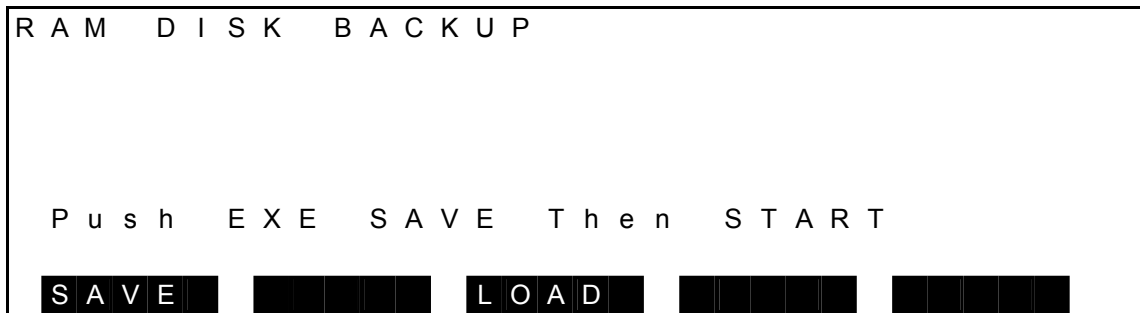

During the backup process, "Saving" is displayed on the screen.
The backup process is complete when this message no longer appears.

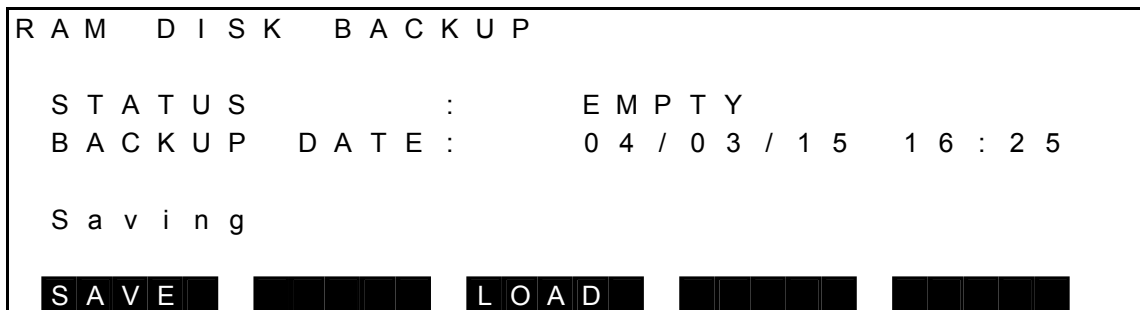

The status when writing to the flash memory is shown below.

- STATUS Indicates the backup status.
 - EMPTY Empty
 - 3 FILES 1024 BYTES

In the above example, 1024 bytes are used in three files.
- BACKUP DATE Indicates the date that the backup was made.

(c) Step 2: Reload.
Press [LOAD].

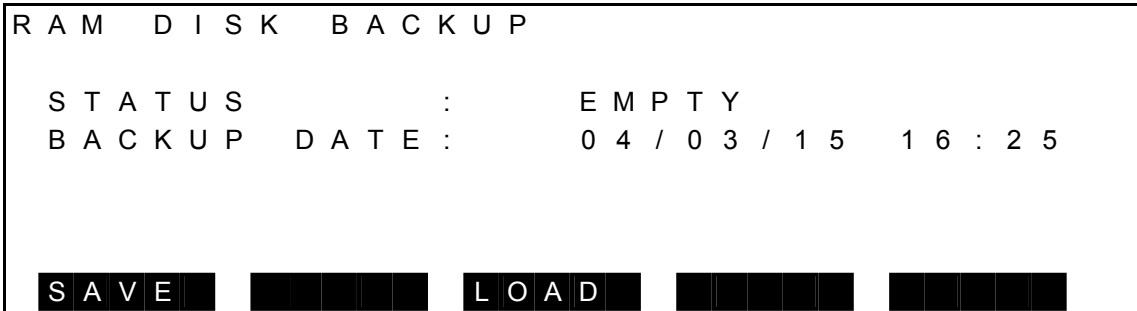

Press the EXE key.

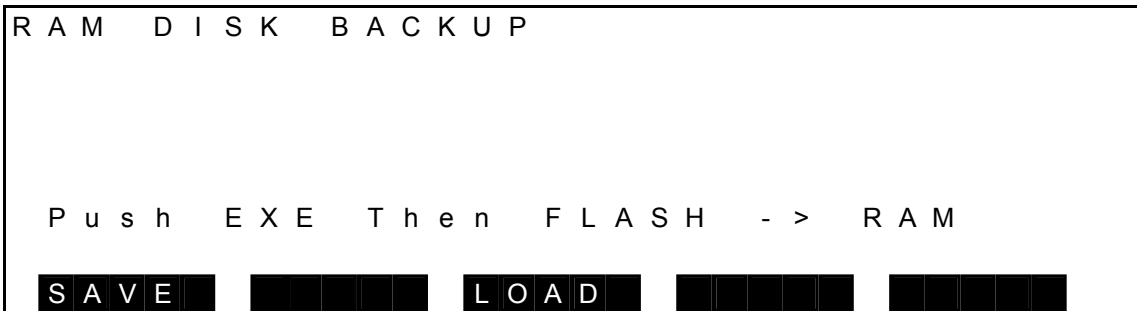

Press the EXE.

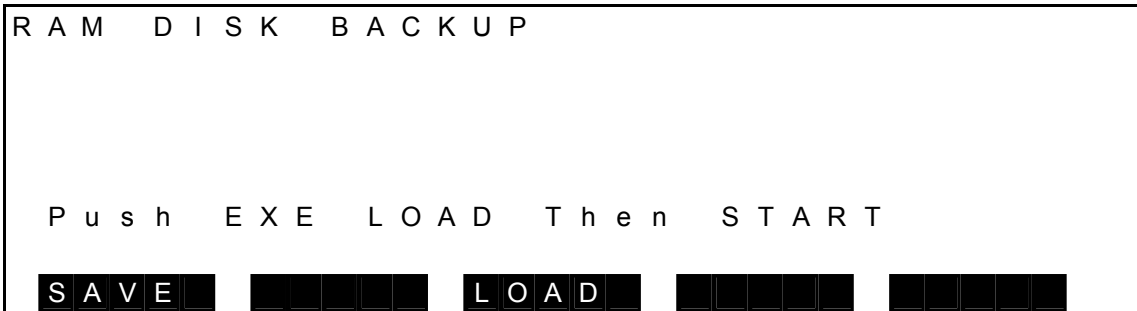

Press the EXE key to start reloading.

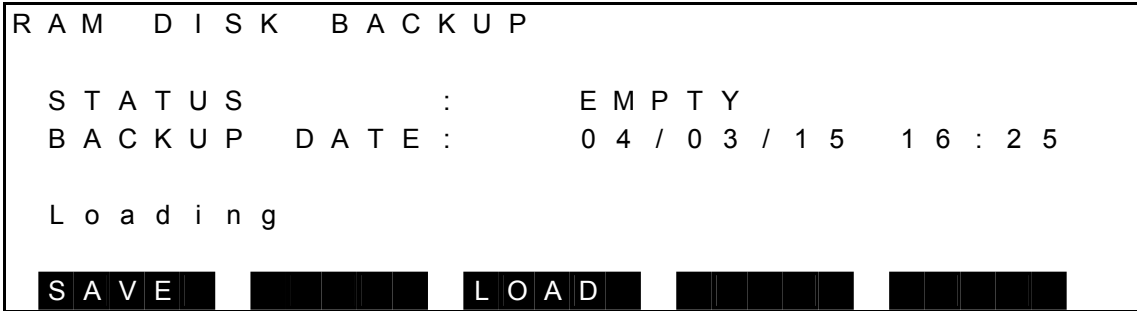

During the reloading process, "Loading" is displayed on the screen.
The reloading process is complete when this message no longer appears.
LOAD is prohibited if there is no backup file in the flash memory.

Section 11 Self-Diagnosis

11.1 Classification of Errors

Errors detected by the self-diagnosis function are grouped and processed as described in the Alarm Manual.

11.2 Display at Error Generation

- TS3000** : If an error has occurred, the buzzer sounds intermittently and the relevant error number flashes on the display when "ALARM" is selected beforehand by means of the SELECT switch on the control panel.
If the error level is 2, 4 or 8, the "fault" external control signal turns on. At the time of emergency stop, the buzzer will not sound and the "fault" signal will not turn on.
To reset the alarm buzzer, press the STOP pushbutton switch on the control panel, or execute the reset operation stated in Para. 11.4.
- TSL3000** : When an error occurs, the buzzer sounds intermittently, and the ALARM LED on the controller front panel turns on.
If the error level is 2, 4, or 8, the "fault" external control signal turns on. At the time of emergency stop, the buzzer will not sound and the "fault" signal will not turn on.
To reset the alarm buzzer, execute the reset operation described in Para. 11.4, "Error Reset".

11.3 Error Display

(1) Function

Displays the code number and description of an error which is detected currently or which is not yet to be reset.

(2) Procedures

(a) Step 1: Input of error display.

Press the ERROR key equipped on the teach pendant, and the following display appears.

[Error message display]

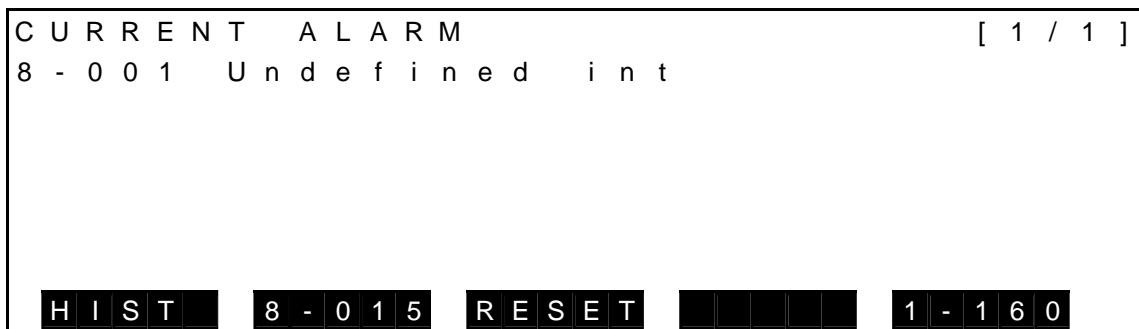

(b) Step 2: Error display.

Keys operative in this mode and their operations are shown below.

Key	Descriptions
ALT +	Used to display the previous page. (If errors which have not yet been reset are covered on two or more pages.)
ALT +	Used to display the next page. (If errors which have not yet been reset are covered on two or more pages.)
	Used to display an error message.
	Used to display the time of error generation.
ESC	Used to return the system to the previous display.

[Error time display]

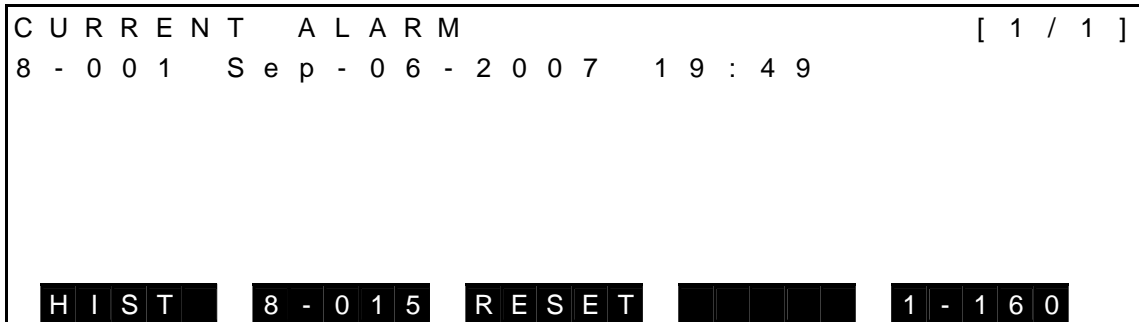

(3) Caution

When the ESC key is pressed, the system quits the error display and returns to the previous display. Error display is possible, irrespective of the mode currently selected.

11.4 Error Reset

(1) Function

Resets the error display, "fault" signal and buzzer after the error has been corrected.

(2) Procedures

(a) Step 1: Input of error display.

Press the ERROR key equipped on the teach pendant, and following display appears.

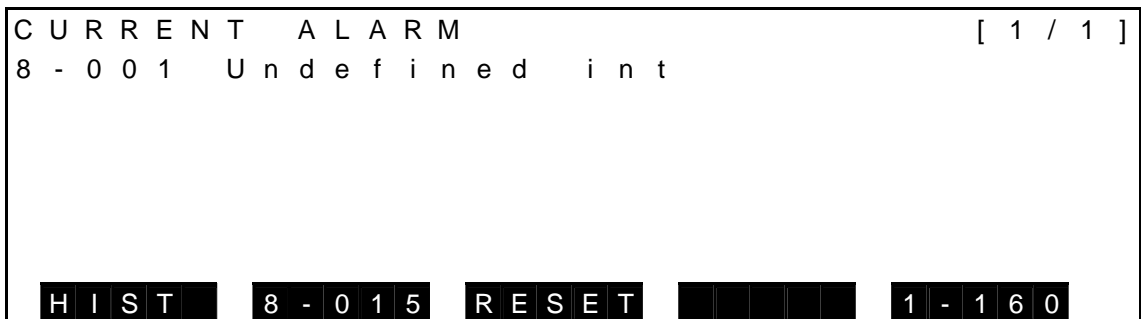

(b) Step 2: Reset input.

Press the function key corresponding to the [RESET] menu. After the error has been reset, another error, if any, is displayed in its place.

(3) Cautions

- The soft limit and emergency stop are automatically reset after a relevant error has been corrected.
- Even if the reset operation is performed, if the cause of the error is not removed, the error will occur again. In this cause, the error occurrence time is updated after the reset operation.

11.5 Error Reset by External Signal

(1) Function

Resets all errors whose causes have been cleared.

(2) Procedures

(a) Use the master key to switch to EXT. SIG mode.

(b) Set the ALARM_RST signal to "ON" to reset the error.

(3) Caution

This function can be executed, irrespective of presence or absence of the teach pendant.

11.6 Error History Display

- (1) Function
Displays the history number, code number and time of error generation in the order in which errors occurred.
- (2) Procedures
 - (a) Step 1: Input of error display.
Press the ERROR key on the teach pendant, and the following display appears.

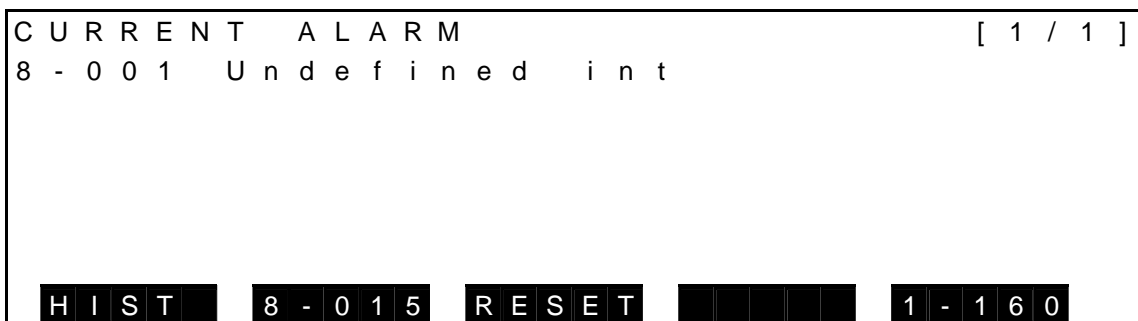



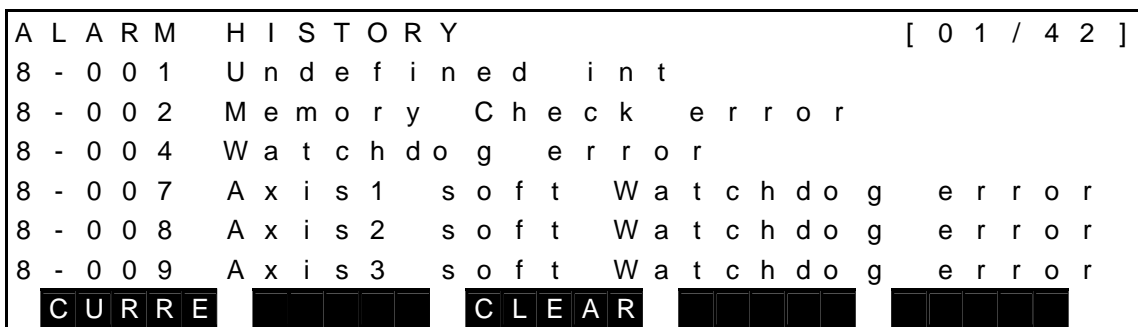

- (b) Step 2: Input of history.
Press the function key corresponding to the [HIST] menu, and the following error history display appears.

[Error message display]



(c) Step 3: Error history display.

Keys operative in this mode and their operations are shown below.

Key	Descriptions
ALT + 	Used to display the previous page. (If errors which have not yet been reset are covered on two or more pages.)
ALT + 	Used to display the next page. (If errors which have not yet been reset are covered on two or more pages.)
	Used to display an error message.
	Used to display the time of error generation.
ESC	Used to return the system to the previous display.
CLEAR	Used to clear the error history.

[Error time display]

A L A R M H I S T O R Y			[0 1 / 4 2]
8 - 0 0 1	S e p - 0 8 - 2 0 0 7	1 9 : 5 9	
8 - 0 0 2	S e p - 0 7 - 2 0 0 7	1 9 : 4 9	
8 - 0 0 4	S e p - 0 6 - 2 0 0 7	1 9 : 3 9	
8 - 0 0 7	S e p - 0 5 - 2 0 0 7	1 9 : 2 9	
8 - 0 0 8	S e p - 0 5 - 2 0 0 7	1 9 : 2 9	
8 - 0 0 9	S e p - 0 5 - 2 0 0 7	1 9 : 2 9	
C U R R E		C L E A R	

(d) Step 4: Error display.

Press the function key corresponding to the [CURRE] menu, and the display of error or errors currently generated is shown.

(e) Step 5: Clear history.

Press the function key corresponding to the [CLEAR] menu, and the error history is cleared.

(3) Caution

A maximum of 128 errors can be recorded. If the number of errors saved exceeds 128, old errors are overwritten in order by the new ones.

11.7 Compile Error Display

(1) Function

If an error occurs in the program, a compiler error occurs during selection of a program.

Displays the details of a compile error and the line in which the error occurred.

(2) Procedures

(a) Step 1: Input of error display.

Press the ERROR key on the teach pendant, and the following display appears.

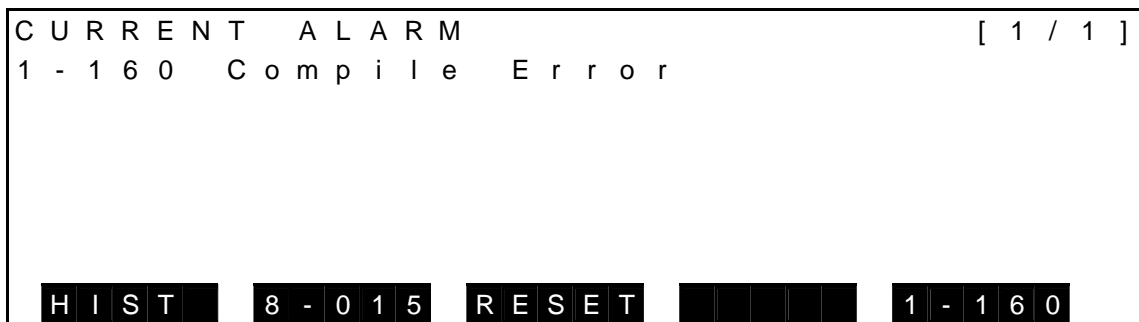

(b) Step 2: Input of compile error detailed display.

Press the function key corresponding to the [1-160] menu, compile error detailed display menu.

[Compile error message detailed display]

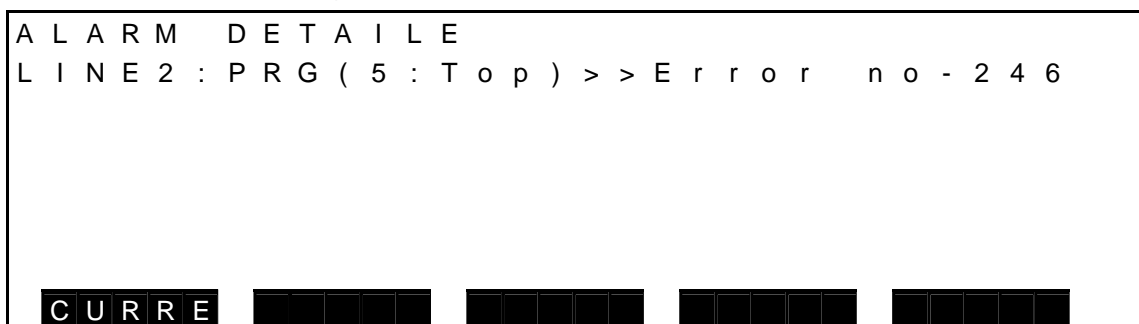

The screen for the compile error message detailed display is shown above. The compile errors are shown in the following format:

Error occurrence line number: Error occurrence block (Line number from top line: TOP) > Error number.

For details about specific errors, refer to the Appendix "Compile Error and Compile Warning Messages" in the Robot Language Manual.

(c) Step 3: Error display.

Press the function key corresponding to the [CURRE] menu, and the display of error or errors currently generated is shown.

