

# TS3000 series Robot Controller

---

TS3000 SCARA / LINEAR system  
TS3100 SCARA / LINEAR / 6AXIS system  
TSL3000 SCARA system  
TSL3100 6AXIS system

## INSTRUCTION MANUAL

### FIELD BUS SLAVE FUNCTION MANUAL

#### Notice

1. Make sure that this instruction manual is delivered to the final user of Toshiba Machine's industrial robot.
2. Before operating the industrial robot, read through and completely understand this manual.
3. After reading through this manual, keep it nearby for future reference.

TOSHIBA MACHINE CO., LTD.  
NUMAZU, JAPAN

---

Copyright 2014 by Toshiba Machine Co., Ltd.  
All rights reserved.

No part of this document may be reproduced in any form without obtaining prior written permission from Toshiba Machine Co., Ltd.

The information contained in this manual is subject to change without notice to effect improvements.

## Preface

This manual describes the initial setting procedures and operating method of the field bus slave function, the TS3000/TS3100/TSL3000/TSL3100 (referred to as TS3000 series below) robot controller extension function. It is intended for users with general knowledge of field bus.

The slave module for the field bus can select either of the three (3) types; PROFIBUS, DeviceNet or CC-Link, which should be determined at order entry.

The field bus input signals are assigned to DIN301 to DIN364 and DIN401 to DIN464, and the output signals are assigned to DOUT301 to DOUT364 and DOUT401 to DOUT464. Also, the Simple PLC Function (option) can be used to enable changing of the I/O and routing of the system signal I/O through the field bus.

Instruction manuals which are referred to from this manual

- Robot language manual
- Operation manual
- User parameter manual
- Maintenance manual
- Instruction manual of master station you wish to use



 <b>CAUTION</b>	This manual does not contain any detailed descriptions on power and robot connection. For the connection of the power and robot, see the Installation & Transport Manual.
--	---

**Cautions on Safety**

This manual contains the important information on the robot and controller to prevent injury to the operators and persons nearby, to prevent damages to assets and to assure correct use.





Make sure that you well understand the following details (indications and symbols) before reading this manual. Always observe the information that is noted.

[Explanation of indications]

Indication	Meaning of indication
 <b>DANGER</b>	This means that "incorrect handling will lead to fatalities or serious injuries."
 <b>CAUTION</b>	This means that "incorrect handling may lead to personal injuries <sup>1)</sup> or physical damage <sup>2)</sup> ."

- Injuries refer to injuries, burns and electric shocks, etc., which do not require hospitalization or long-term medical treatment.
- Physical damage refers to damages due to destruction of assets or resources.



[Explanation of symbols]



Symbol	Meaning of symbol
	This means that the action is prohibited (must not be done). Details of the actions actually prohibited are indicated with pictures or words in or near the symbol.
	This means that the action is mandatory (must be done). Details of the actions that must be done are indicated with pictures or words in or near the symbol.
	This means danger. Details of the actual danger are indicated with pictures or words in or near the symbol.
	This means caution. Details of the actual caution are indicated with pictures or words in or near the symbol.

 <b>CAUTION</b>	To perform the work ranging from robot installation to operation with safety, read through and through the Safety Manual provided separately before actually starting the work.
--	---

**Maintenance and Inspection**

To use the robot safety, strictly observe the following matters.

 <b>DANGER</b>	
 Prohibited	<ul style="list-style-type: none"> <li>• NEVER burn, disassemble or charge the battery. Otherwise, it may explode.</li> </ul>
 Mandatory	<ul style="list-style-type: none"> <li>• Before performing the maintenance and inspection, be sure to turn off the main power switch of the controller.</li> <li>• When disposing of batteries, be sure to follow the user's regulations.</li> </ul>

 <b>CAUTION</b>	
 Disassembly prohibited	<ul style="list-style-type: none"> <li>• The user should NEVER replace or change parts other than those stipulated in the instruction manual. Otherwise, the performance will deteriorate, resulting in troubles.</li> </ul>
 Mandatory	<ul style="list-style-type: none"> <li>• To replace parts, use the spare parts designated by Toshiba Machine.</li> <li>• Carry out the maintenance and inspection on a regular basis. Otherwise, the equipment may go wrong or accidents will be caused.</li> </ul>

 <b>CAUTION</b>	To perform the maintenance and inspection of the robot with safety, read through and through the Maintenance Manual provided separately before actually starting the work.
--	--

Table of Contents

	Page
1. Operation Flow .....	7
2. Hardware Structure .....	9
2.1 Field Bus Printed Board Assembling Procedures to the TS3000/TS3100 Controller .....	9
2.2 Installing the Printed Board in the TSL3000/TSL3100 Controller .....	12
2.3 Connection.....	14
2.3.1 Pin Array of Connector for Connecting External Equipment.....	14
2.3.2 Connection .....	16
3. Field Bus Slave Module.....	17
3.1 PROFIBUS Slave Module Specifications.....	17
3.1.1 PROFIBUS Specifications .....	17
3.1.2 Setting of PROFIBUS User Parameter.....	18
3.2 DeviceNet Slave Module Specifications .....	20
3.2.1 DeviceNet Specifications.....	20
3.2.2 Setting of DeviceNet User Parameter .....	21
3.3 CC-Link Slave Module Specifications .....	23
3.3.1 CC-Link Specifications.....	23
3.3.2 Setting of CC-Link User Parameter .....	24
4. Input/Output Addresses.....	26
5. Error Detection .....	26
6. Verifying Motion.....	27
7. How to Use SCOL Language Instruction.....	30
7.1 Sample Program .....	31
8. Fieldbus System Signal Input/Output Function .....	32
9. Simple PLC Function (TCmini) .....	34
9.1 Bit Input (FieldBUS→TCmini) .....	34
9.2 Bit Output (TCmini→FieldBUS) .....	34
9.3 Data Input (CC-Link→TCmini) *CCLink only .....	34
9.4 Data Output (TCmini→CC-Link) *CCLink only .....	34

## 1. Operation Flow

The operation flow to enable the field bus interface is given below.

\* When specifying the Field Bus during the purchase of the robot controller, read the step (2) Connecting with the master station and skip to step (4) Setting the master station and go to later steps.

(1) Mounting the field bus ... See Section 2 of this manual.

Mount the field bus you procured on the controller.

Uncover the controller and perform the manual work.

Before starting this work, be sure to turn the power off.

When you already specified the field bus at order entry of the robot, the bus is factory-set. Make sure of it.

To proceed with the next process, the controller should remain uncovered.



(2) Connecting with the master station ... See Section 2 of this manual.

Connect the field bus terminal on the controller side with the field bus cable connecting to the master station.



(3) Setting the controller parameters ... See Section 3 of this manual, the operation manual and user parameter manual.

Turn on the controller power, edit the [U16 FIELD BUS] parameter contained in the user parameter (USER.PAR) file.

The user parameter becomes operative after the power is turned off once, then on again.



(4) Setting the master station ... See Section 3 of this manual and the master station instruction manual.

Perform setting of the master station. The setting procedures differ with the master station to be used. Refer to the master station instruction manual you procured.







- (5) Confirming the operation ... See Section 5 of this manual and the master station instruction manual.

The power is turned on in order of “First Field Bus master” and “Robot controller”.

To make sure that the I/Os assigned to the robot controller can be operated properly, set ON the switch assigned from the master station and monitor the I/O status from the robot controller. Also, set ON the switch on the robot controller side and monitor the I/O state from the master station to make sure that the information can be transmitted legally.

If an error has generated, investigate the error information from the master station.



- (6) Creating the robot program and verifying the control ... See Section 6 of this manual and the master language instruction manual.

Create the robot program, referring to the example of robot program creation and make sure that the I/Os on the field bus can be controlled, using the SCOL language.



- (7) Finish of the work

Now the work has finished. Turn off the controller power and cover the controller.

**2. Hardware Structure**

**2.1 Field Bus Printed Board Assembling Procedures to the TS3000/TS3100 Controller**

Assemble the Field Bus printed board in the manner described below.

- (1) Turn off the power of the robot controller.
- (2) Turn off the main power of 200V supplied to the robot controller. Disconnect the power connector (ACIN–CN1) to assure safety.
- (3) Remove the top cover of the robot controller.  
 This top cover is secured with a total of twelve (12) screws (M3 × 6) (eight (8) screws each on the both lateral sides and four (4) screws on the top side of the robot controller. Remove the screws, using a screwdriver, then draw the cover to side and remove.

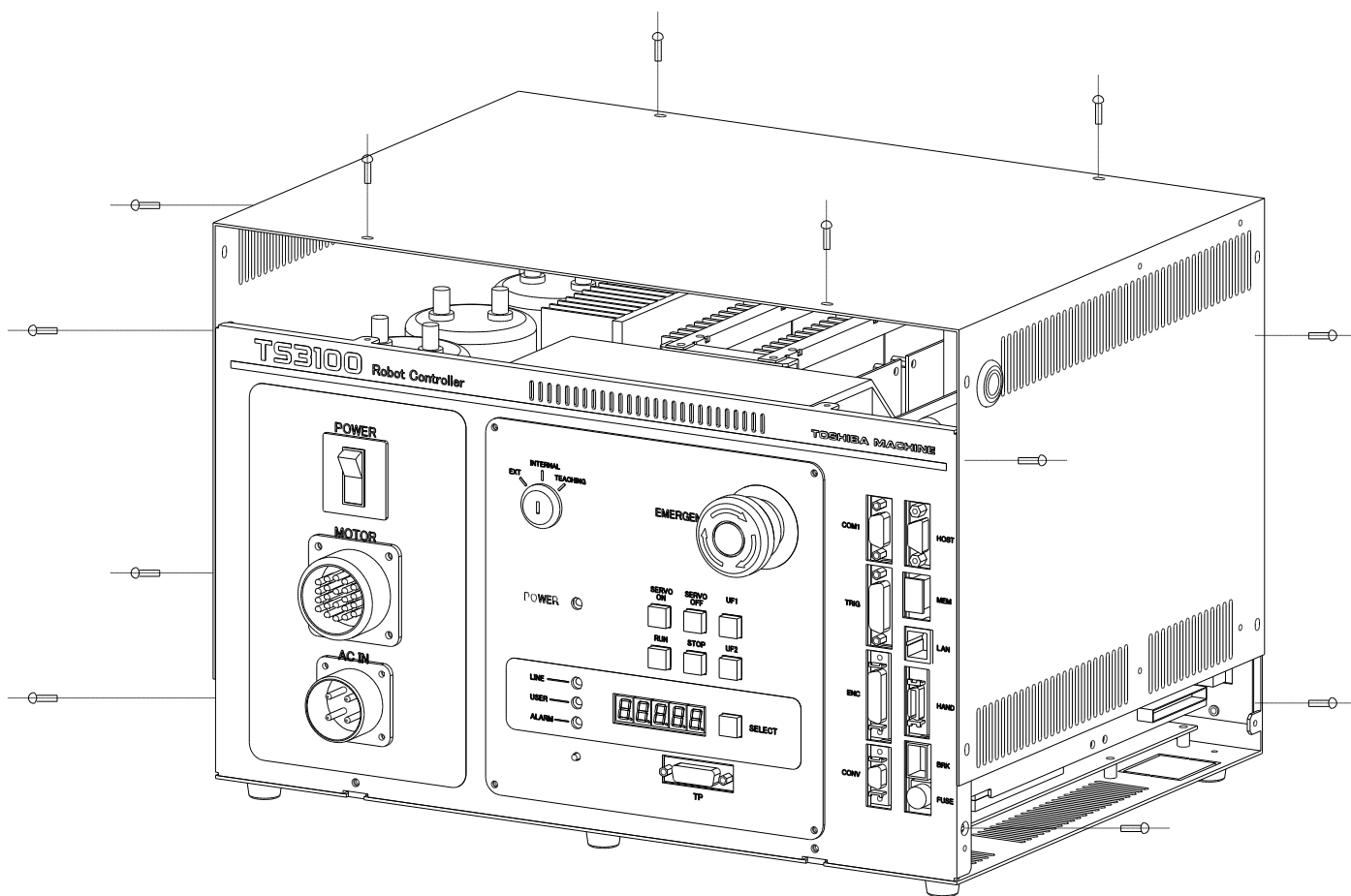

Fig. 1 Removing the TS3000/TS3100 Cover

- (4) Remove the dummy connector plate attached to the rear side of the robot controller.

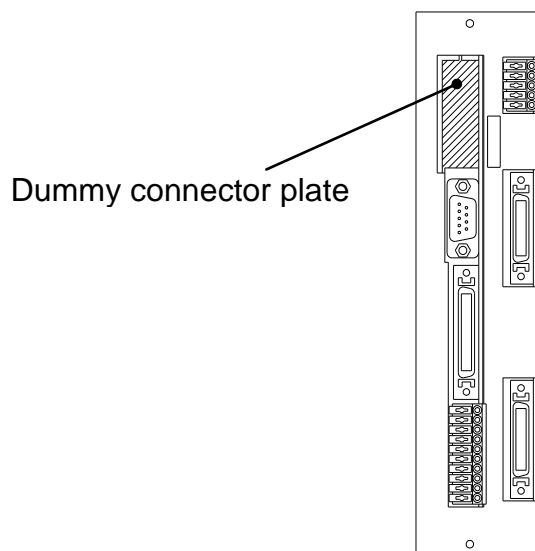

Fig. 2 Rear Side of the TS3000/TS3100 Robot Controller

- (5) Remove the mounting screws on the X8GC printed board.
- (6) Insert the field bus printed board into CN19 of the X8GC printed board
- (7) Use the screws to secure the printed board in place.

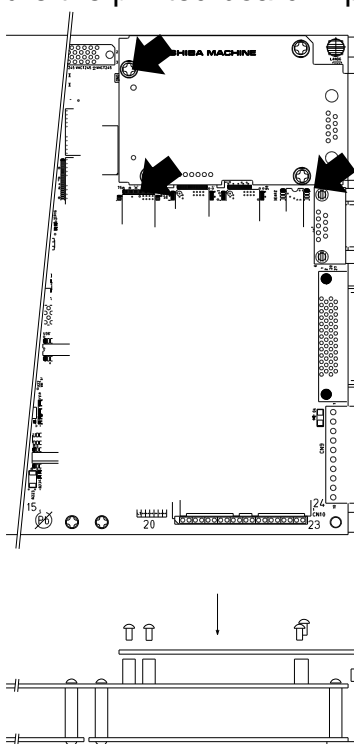

Fig. 3 Top View and Side View of TS3000/TS3100 Controller (After Installation of Field Bus Printed Board)

- 8) Attach the cover to the robot controller as originally set, then secure it with the screws.

Reference: After installing each field bus printed board, the appearance will be as shown in Fig. 4.

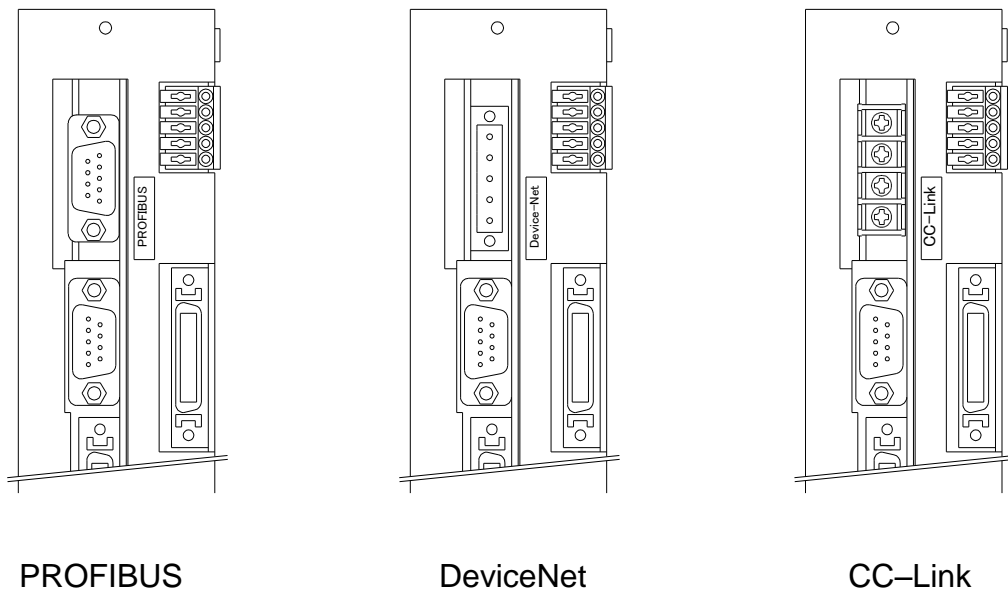

Fig. 4 Rear View of TS3000/TS3100 Controller  
(After Instillation of Field Bus Printed Boards)

**2.2 Installing the Printed Board in the TSL3000/TSL3100 Controller**

Use the procedure below to install the field bus printed board into the robot controller.

(1) Turn off the 200V power supplied to the robot controller from the primary side. To ensure safety, disconnect the power connector (ACIN).

(2) Remove the top cover of the robot controller.

The top cover is secured using a total of eight (8) countersunk screws (M3x10 black) with four screws on the side panel and four screws on the top panel of the robot controller. Use a screwdriver to remove the screws, and pull the cover towards the front to remove.

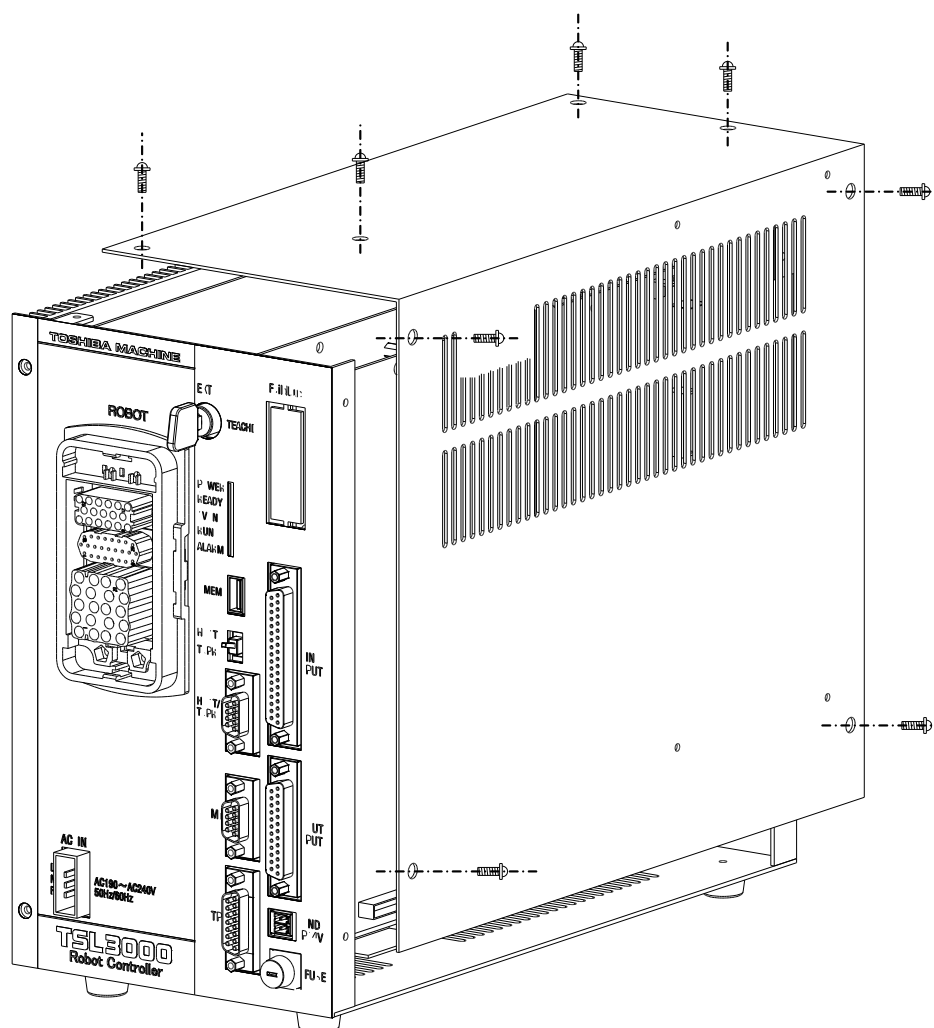

Fig. 5 Removing the TSL3000/TSL3100 Cover

- (3) Remove the dummy connector plate (shown as the cross-hatched section in Fig. 6) on the rear panel of the robot controller.

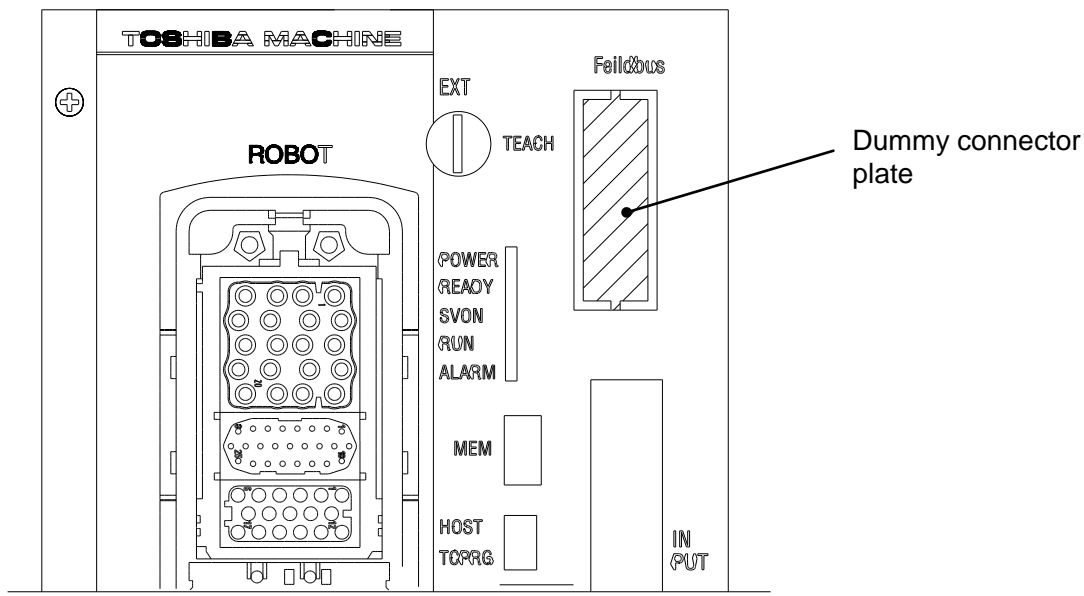

Fig. 6 TSL3000/TSL3100 Robot Controller Front Panel Top

- (4) Remove the mounting screws on the X8YX printed board.
- (5) Insert the field bus printed board into CN6 of the X8YX printed board.
- (6) Use the screws to secure the printed board in place.

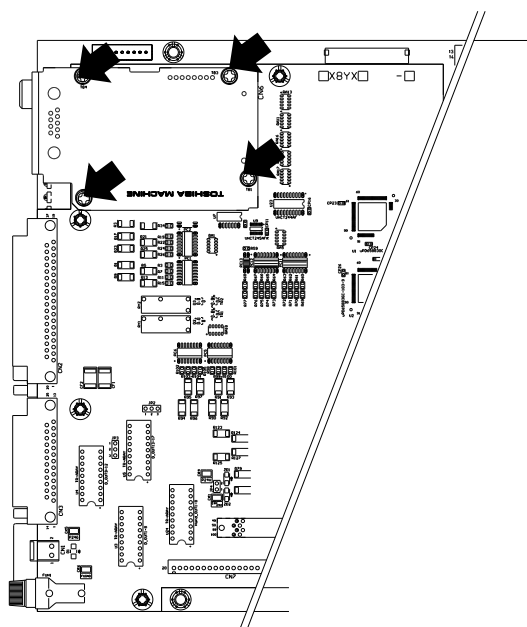

Fig. 7 TSL3000/TSL3100 Robot Controller Side Panel  
(After Installation of Field Bus Printed Board)

(7) Remount the cover onto the robot controller, and secure in place using the screws.

Reference: Fig. 8 shows the appearance after each type of field bus printed board is installed.

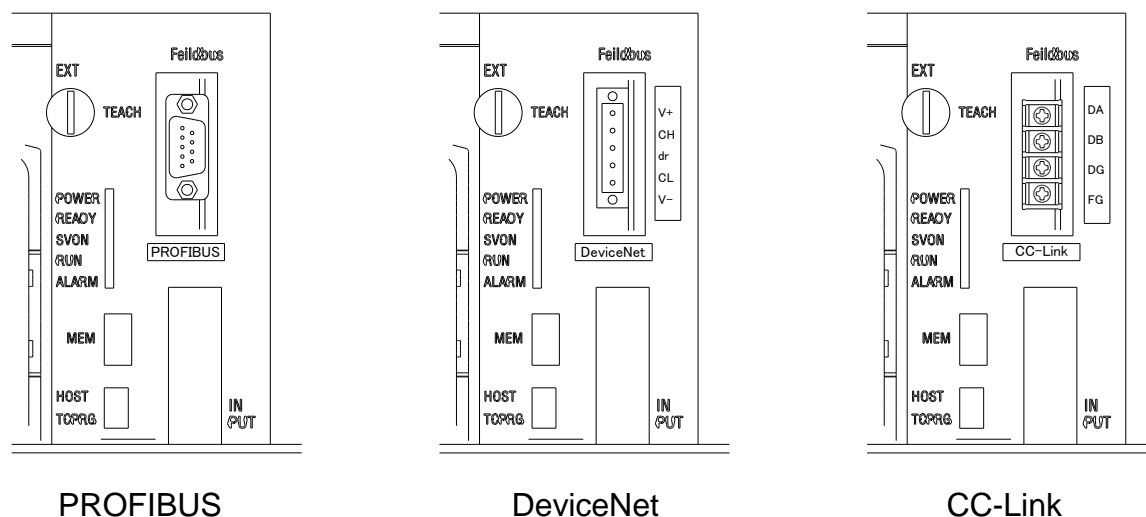

Fig. 8 TSL3000/TSL3100 Controller Front Panel (After Installation of Field Bus Printed Board)

### 2.3 Connection

#### 2.3.1 Pin Array of Connector for Connecting External Equipment

The pin array of the Field bus connector in the controller panel is as shown below.

##### (a) PROFIBUS

Pin No.	Signal name	Application
Housing	SHIELD	Connected to PE.
1	—	Not connected.
2	—	Not connected.
3	RXD (B-line)	Positive RxD/TxD according to RS485 specifications.
4	RST	Request to send
5	GND (V-)	Isolated GND from RS485 side.
6	P5V (V+)	Isolated P5V from RS485 side.
7	—	Not connected.
8	TXD (A-line)	Negative RxD/TxD according to RS485 specifications.
9	—	Not connected.

Field bus connector: 9pin D\_SUB (female)

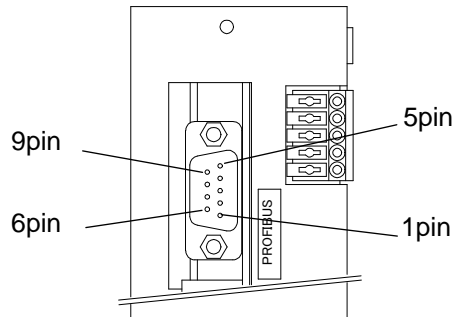

TS3000/TS3100

TSL3000/TSL3100

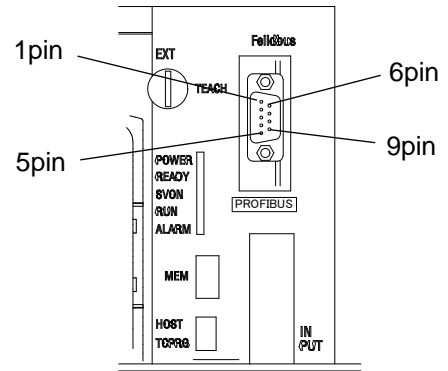

(b) DeviceNet

Pin No.	Signal name	Application
1	24G (V-)	Negative supply voltage
2	CAN_L	CAN_L bus line
3	SHIELD	Cable shield
4	CAN_H	CAN_H bus line
5	P24V (V+)	Positive supply voltage

Field bus connector: 5.08 pluggable screw

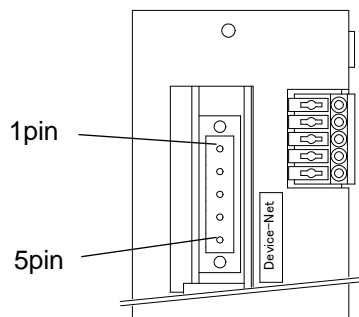

TS3000/TS3100

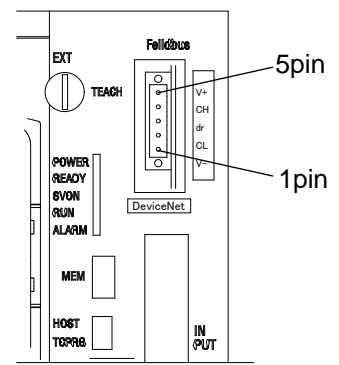

TSL3000/TSL3100



(c) CC-LINK

Pin No.	Signal name	Application
1	DA	Communication line (DA)
2	DB	Communication line (DB)
3	DG	Digital GND (DG)
4	SHIELD	Cable shield

Field bus connector: Terminal block

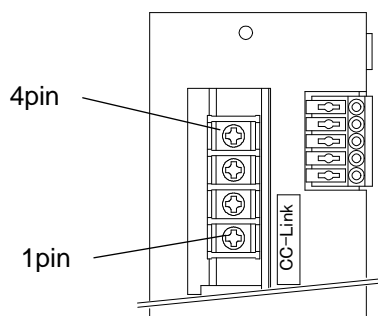

TS3000/TS3100

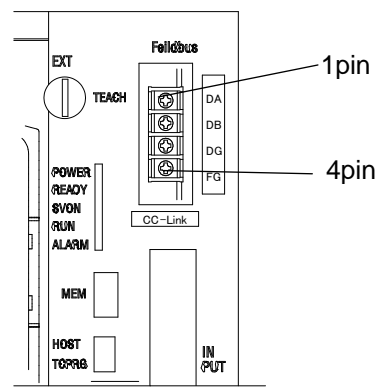

TSL3000/TSL3100

2.3.2 Connection

For the cable connecting the external equipment, use the recommended cable of the master sequencer (PLC) you use.

Use the following cable for the connector on the cable side.

- (a) PROFIBUS : XM2D-0901 made by OMRON
- (b) DeviceNet : MSTB2.5/5-STF-5.08 made by Phoenix
- (c) CC-Link : V1.25-M3

**3. Field Bus Slave Module**

**3.1 PROFIBUS Slave Module Specifications**

3.1.1 PROFIBUS Specifications

Field bus specifications	PROFIBUS
Module name	W8XOA
Master operation	Not supported.
Master device	16-bit little endian device (e.g., Siemens S7 315DP2) 16-bit big endian device
Node address	The node address is specified by user parameter (1 to 125).
Baudrate	Automatic detection (9.6 kbps, 19.2 kbps, 45.45 kbps, 93.75 kbps, 187.5 kbps, 500 kbps, 1.5 Mbps, 3 Mbps, 6 Mbps, 12 Mbps)
GSD file	Each device on the PROFIBUS network relates to the GSD file containing all required information on the devices.  The GSD file is used to establish the network. The basic settings can be made by loading this file. The GSD file is contained in the Instruction Manual CD.
Number of inputs	128 numbers (DIN301 to 364, DIN401 to 464)
Number of outputs	128 numbers (DOUT301 to 364, DOUT401 to 464)

### 3.1.2 Setting of PROFIBUS User Parameter

The PROFIBUS user parameter should be specified, using [U16] of the USER.PAR file. The contents of [U16] are shown below.

**= (Type of field bus) (Node) (Baudrate) (Type of master)**

[U16] FIELD BUS = 1 3 -1 0
-------------------------------

- (Type of field bus) : Specify the type of the field bus.  
Specify "1" for the PROFIBUS.  
-1 : Without any field bus option (initial value)  
1 : PROFIBUS
- (Node) : Specify the node address of the field bus.  
Take careful precautions not to share the same address with any other device in the same network.  
The range of the set value differs with the type of the field bus.  
-1 : Without any field bus option (initial value)  
0 to 127 : Effective range of PROFIBUS node address
- (Baudrate) : Specify the baudrate.  
PROFIBUS baudrate is set from the master side. As the robot controller automatically detects it, the baudrate need not be specified on the robot controller side.

- (Type of master) : Specify the type of the field bus master.  
As the byte order (endian) differs with the master, specify the type according to the master. Set this parameter when connecting to a master where the order of the upper or lower bytes of the IO data that was input/output is different.
- 0 : 16-bit big endian (DRM21 by Omron, A1SJH by MELSEC)  
(Example: 0x1234→0x1234: No conversion)
  - 1 : 16-bit little endian (S7 315DP2 made by Siemens)  
(Example: 0x1234→0x2143)
  - 2 : 32bit big endian  
(Example: 0x1234→0x3412)
  - 3 : 32-bit little endian  
(Example: 0x1234→0x4321)

Example setting:

When the PROFIBUS is selected, the node address is 2 and Siemens's S7 315DP2 is used as the master module:

[U16] FIELD BUS

{Type / Node Addr / Speed / Byte Order}

= 1 2 -1 1

Example setting:

When the field bus slave module is neglected:

[U16] FIELD BUS

{Type / Node Addr / Speed / Byte Order}

= -1 -1 -1 -1

**3.2 DeviceNet Slave Module Specifications**

3.2.1 DeviceNet Specifications

Field bus specifications	DeviceNet
Module name	W2XOA
Module type	Slave
Master/scanner operation	Not supported.
Master device	16-bit little endian device 16-bit big endian device (e.g., OMRON DRM21)
Node address	An exclusive node address is assigned to the DeviceNet on the network. The node address consists of 1 to 63, which is used to identify each node.  The node address is specified by user parameter.
Baudrate	The baudrate is specified by user parameter. 0: 125 kbps                      1: 250 kbps 2: 500 kbps
EDS file	Each device on the DeviceNet network relates to the EDS file containing all required information on the devices.  The EDS file is used during network configuration.  The basic settings can be made by loading this file.  The EDS file is contained in the Instruction Manual CD.
Explicit message	Not supported.
I/O message	Not supported.
Predefined Master/SlaveConnectionSet	
Polling	Supported.
Bit strobe	Supported.
Cyclic	Supported.
Change of state	Supported.
Number of inputs	128 numbers (DIN301 to 364, DIN401 to 464)
Number of outputs	128 numbers (DOUT301 to 364, DOUT401 to 464)

### 3.2.2 Setting of DeviceNet User Parameter

The DeviceNet user parameter should be specified, using [U16] of the USER.PAR file. The contents of [U16] are shown below.

**= (Type of field bus) (Node) (Baudrate) (Type of master)**

[U16] FIELD BUS = 37 1 2 1
-------------------------------

- (Type of field bus) : Specify the type of the field bus.  
Specify "37" for the DeviceNet.  
-1 : Without any field bus option (initial value)  
37 : DeviceNet
- (Node) : Specify the node address of the field bus.  
Take careful precautions not to share the same address with any other device in the same network.  
The range of the set value differs with the type of the field bus.  
-1 : Without any field bus option (initial value)  
0 to 63 : DeviceNet
- (Baudrate) : Specify the baudrate according to the master baudrate.  
0 : 125 kbps  
1 : 250 kbps  
2 : 500 kbps
- (Type of master) : Specify the type of the field bus master.  
As the byte order (endian) differs with the master, specify the type according to the master.  
0 : 16-bit big endian (DRM21 made by OMRON)  
1 : 16-bit little endian  
2 : 32-bit big endian  
3 : 32-bit little endian

Example setting 1:

When the DeviceNet is selected, the node address is 2, the baudrate is 125 kbps and OMRON DRM21 is used as the master module:

[U16] FIELD BUS

{Type / Node Addr / Speed / Byte Order}

= 37 2 0 0

Example setting 2:

When the field bus slave module is neglected:

[U16] FIELD BUS

{Type / Node Addr / Speed / Byte Order}

= -1 -1 -1 -1

### 3.3 CC-Link Slave Module Specifications

#### 3.3.1 CC-Link Specifications

Field bus specifications	CC-Link Version 1.10
Module name	W1XOA
Module type	Remote device
Master device	16-bit little endian device 16-bit big endian device (e.g., MELSEC A1SJH)
Node address	The node address is specified by user parameter (1 to 64).
Baudrate	The baudrate is specified by user parameter. 0: 156 kbps      1: 625 bps      2: 2.5 Mbps 3: 5 Mbps      4: 10 Mbps
No. of occupied stations	Four (4) stations
Number of inputs	128 numbers (DIN301 to 364, DIN401 to 464) *
Number of outputs	128 numbers (DOUT301 to 364, DOUT401 to 464) *

\* Due to the CC-Link specifications, the last two I/O terminals of 128 numbers are designed to be used for the system; and are not applicable to users.



### 3.3.2 Setting of CC-Link User Parameter

The CC-Link user parameter should be specified, using [U16] of the USER.PAR file. The contents of [U16] are shown below.

**= (Type of field bus) (Node) (Baudrate) (Type of master)**

[U16] FIELD BUS = -1 -1 0 0
--------------------------------

- (Type of field bus) : Specify the type of the field bus.  
-1 : Without any field bus option (initial value)  
144 : CC-Link
- (Node) : Specify the node address of the field bus.  
Take careful precautions not to share the same address with any other device in the same network.  
The range of the set value differs with the type of the field bus.  
-1 : Without any field bus option (initial value)  
1 to 64 : CC-Link
- (Baudrate) : Specify the baudrate according to the master baudrate.  
Specify the CC-Link baudrate  
0 : 156 kbps  
1 : 625 kbps  
2 : 2.5 Mbps  
3 : 5 Mbps  
4 : 10 Mbps
- (Type of master) : Specify the type of the field bus master.  
As the byte order (endian) differs with the master, specify the type according to the master.  
0 : 16-bit big endian (A1SJH made by MELSEC)  
1 : 16-bit little endian  
2 : 32-bit big endian  
3 : 32-bit little endian

Example setting:

When the CC-Link is selected, the node address is 2, the baudrate is 156 kbps and MELSEC's A1SJH is used as the master module:

[U16] FIELD BUS  
{Type / Node Addr / Speed / Byte Order}  
= 144 2 0 0

Example setting:

When the field bus slave module is neglected:

[U16] FIELD BUS  
{Type / Node Addr / Speed / Byte Order}  
= -1 -1 -1 -1

#### 4. Input/Output Addresses

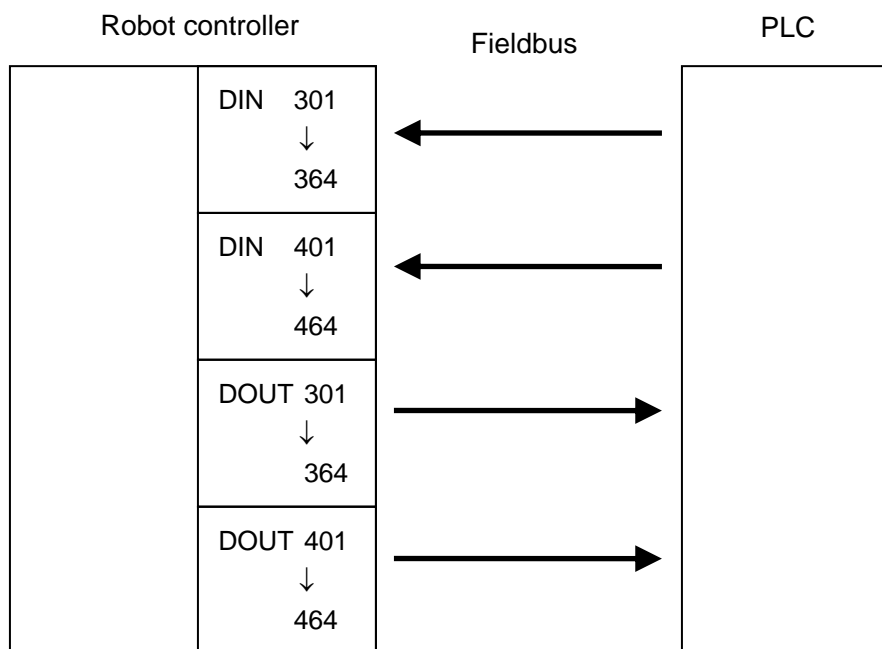

#### 5. Error Detection

- 8-353 Field bus Parameter error  
The field bus parameter set value is wrong. Reset the parameter and then turn the power supply off, then on again.
  
- 8-354 Field bus Offline  
The controller and master device side are offline status. This error will be retained until changed to an online status. This error brings the moving robot to an emergency stop.. Check to find out the detailed causes for the offline status on the field bus master device side.
  
- 8-355 Field bus Board error  
There has been a discrepancy between the set parameter and the installed printed board. Alternatively, the printed board has not been installed. Reset the parameter and then turn the power supply off, then on again.

**6. Verifying Motion**

The field bus input signals are assigned to DIN301 to DIN364 and DIN401 to DIN464. The field bus output signals are assigned to DOUT301 to DOUT364 and DOUT401 to DOUT464.

Respective motions of the above signal cables can be confirmed in the utility mode. For detailed operation of the utility mode, see the operation manual provided separately.

Follow the procedures shown below.

(Make sure that the setting of the user parameter and field bus master have finished, and that no error is generated in the field bus or controller.)

Press the **UTILITY** key provided on the teach pendant, and the utility mode is selected and the system calls the following screen on the display.



Press the **F2** key (**I/O**) on the teach pendant, and the external input/output signal display appears. The following standard input signal status display is shown.

I/O	Monitor	(Standard IN)			1/5
		1	10	11	20
DIN	0*	00000	00000	00000	00000
	2*	00000	00000	00000	00000
	4*	00000	00000	00000	00000
	6*	0000			

Press the **NEXT** key or the "**ALT** + **↓**" keys three (3) times to call the page where the inputs from the field bus are displayed.

Now, you can make sure that the one-hundred-twenty-eight (128) field bus input signals assigned from the master side can be turned on and off.

The input or output signal status is "1" when the contact is open. It is "0" when the contact is closed. A total of twenty (20) signals, separated by every five (5) signals, are displayed on the same line with the leading signal number shown on the left end.

Page 1 (Field bus input)

I/O	Monitor	(Fieldbus 1 IN)				4/5
	1	10	11		20	
DIN30*	00000	00000	00000	00000	00000	
32*	00000	00000	00000	00000	00000	
34*	00000	00000	00000	00000	00000	
36*	0000					

████████
████████
DIN
DOUT
SYS

Page 2 (Field bus input)

I/O	Monitor	(Fieldbus 2 IN)				5/5
	1	10	11		20	
DIN40*	00000	00000	00000	00000	00000	
42*	00000	00000	00000	00000	00000	
44*	00000	00000	00000	00000	00000	
46*	0000					





████████
████████
DIN
DOUT
SYS

Press **DOUT** to call the output screen.

Press the **NEXT** key or the "**ALT** + **↓**" keys three (3) times to call the page where the outputs from the field bus are displayed.

Now, you can make sure that the one-hundred-twenty-eight (128) field bus output signals can be turned on and off.

The operative keys and contents of operation are listed below.

Key	Descriptions
	Used to move the cursor to the left. When the cursor is located at the left end, it will not move any further.
	Used to move the cursor to the right. When the cursor is located at the right end, it will not move any further.
	Used to move up the cursor. When the cursor is located at the top, it will not move any further.
	Used to move down the cursor. When the cursor is located at the bottom, it will not move any further.
<b>ALT</b> + 	Used to call the next page. When the final page is displayed,

	the page will not change over.
<b>ALT</b> + <b>↑</b>	Used to call the previous page. When the top page is displayed, the page will not change over.
<b>ESC</b>	Used to return the system to the utility screen.

The operative soft keys and contents of operation are listed below.

Key	Descriptions
[ON]	Turns on the bit indicated by the cursor.
[OFF]	Turns off the bit indicated by the cursor.

You can make sure that the signals assigned from the master side can be turned on and off.

Page 1 (Field bus output)

I/O	Monitor	(Fieldbus 1 OUT)			4/5
	1	10	11	20	
DOU T 30 *	00000	00000	00000	00000	00000
32 *	00000	00000	00000	00000	00000
34 *	00000	00000	00000	00000	00000
36 *	0000				

ON

OFF

Page 2 (Field bus output)

I/O	Monitor	(Fieldbus 2 OUT)			5/5
	1	10	11	20	
DOU T 40 *	00000	00000	00000	00000	00000
42 *	00000	00000	00000	00000	00000
44 *	00000	00000	00000	00000	00000
46 *	0000				

ON

OFF

## 7. How to Use SCOL Language Instruction

The field bus signals can be operated by the SCOL language instructions. For details on how to use each instruction of the SCOL language, see the robot language instruction manual.

- DIN : Reads the specified input signal status.
- DOUT : Outputs the specified output signal.
- RESET DOUT : Turns off the user's output signal.
- PULOUT : Outputs the specified output signal in 0.2 second-interval pulse. The output time by the PULOUT instruction to this output area may be longer than 0.2 second, the normal DOUT output time.
- BCDIN : Reads in BCD code the input signals whose length is four (4) times the specified signal length, starting from the specified signal.
- BCDOUT : Converts the value of the expression into the BCD code and outputs the value equivalent to the number of digits as specified by the signal length to the output signals whose length is four (4) times the specified signal length, starting from the specified signal.
- HEXIN : Reads in HEX code the input signals whose length is equivalent to the specified signal length, starting from the specified signal.
- HEXOUT : Converts the value of the expression into the HEX code and outputs the value equivalent to the number of digits as specified by the signal length to the output signals whose length is equivalent to the specified signal length, starting from the specified signal.

## 7.1 Sample Program

This is the program in which the robot waits until input signal 301 turns on, then moves to taught points A1, A2 and A3.

```
PROGRAM DINSAMPLE
WAIT DIN(301)
MOVE A1
MOVE A2
MOVE A3
END
DATA
POINT A3          = 1500.000, 0.000, 0.000, 0.000, 0.000 /
RIGHTY
POINT A2          = 1500.000, 0.000, 0.000, 0.000, 0.000 /
RIGHTY
POINT A1          = 1500.000, 0.000, 0.000, 0.000, 0.000 /
RIGHTY
END
```

This program turns on and off output signals 301 through 316 in turn.

```
PROGRAM DOOTSAMPLE
FOR K=301 TO 316
DOUT(K)
TIMER=0.5
WAIT TIMER==0
DOUT(-K)
NEXT K
END
```



### 8. Fieldbus System Signal Input/Output Function

This function assigns system signal input/output to the fieldbus.

The fieldbus assignment is switched on/off by setting the value of the row 1 column 1 (FUNCTION 1) of the user parameter [U35] SEQUENCE FUNCTION SELECT SWITCH as shown below.

- 0: Function off (This performs input/output of the system signal to the external operation input/output signal line (SYSTEM).)
- 1: Function on (The system signal input/output is assigned to the fieldbus. Input/output to the external operation input/output signal line (SYSTEM) is disabled.)

\* This function is performed by the standard sequences of the Simple PLC built into the TS3000. To change to a user-selected input/output, see 9. Simple PLC Function (TCmini) on the next page and the Simple PLC Function Operation Manual.

User parameter [U35] settings

Function Off setting

[U35] SEQUENCE FUNCTION SELECT SWITCH = <b>0</b> 0 0 0 0 0 0 0
---

Function On setting

[U35] SEQUENCE FUNCTION SELECT SWITCH = <b>1</b> 0 0 0 0 0 0 0
---

When set to 1, the system signal input/output is assigned to the fieldbus.

Fieldbus signal assignment

Input signals

Fieldbus input	When Function Off	When Function On
FIELDBUS_IN-113	DIN(449)	STROBE (Strobe)
FIELDBUS_IN-114	DIN(450)	PRG_RST (Program reset)
FIELDBUS_IN-115	DIN(451)	STEP_RST (Step reset)
FIELDBUS_IN-116	DIN(452)	CYC_RST (Cycle reset)
FIELDBUS_IN-117	DIN(453)	DO_RST (Output signal reset)
FIELDBUS_IN-118	DIN(454)	ALM_RST (Alarm reset)
FIELDBUS_IN-119	DIN(455)	RUN (Run)
FIELDBUS_IN-120	DIN(456)	EX_SVON (External input servo on)
FIELDBUS_IN-121	DIN(457)	STOP (Stop)
FIELDBUS_IN-122	DIN(458)	CYCLE (Cycle operation mode)
FIELDBUS_IN-123	DIN(459)	LOW_SPD (Low speed)

FIELDDBUS_IN-124	DIN(460)	BREAK (Decelerate and stop)
FIELDDBUS_IN-125	DIN(461)	SV_OFF (Servo off)
FIELDDBUS_IN-126	DIN(462)	BZ_RST (Buzzer reset)

\* For details on the system signals, see the Interface Operation Manual.

### Output signals

Fieldbus output	When Function Off	When Function On
FIELDDBUS_OUT-113	DOUT(449)	EMG_ST (Emergency stop state)
FIELDDBUS_OUT-114	DOUT(450)	SV_RDY (Servo operation ready)
FIELDDBUS_OUT-115	DOUT(451)	ACK (Acknowledge)
FIELDDBUS_OUT-116	DOUT(452)	TEACH (Manual mode on)
FIELDDBUS_OUT-117	DOUT(453)	INT (Internal mode on)
FIELDDBUS_OUT-118	DOUT(454)	EXT_SIG (External mode on)
FIELDDBUS_OUT-119	DOUT(455)	EXT_232C (External mode on)
FIELDDBUS_OUT-120	DOUT(456)	SYS_RDY (Operation ready)
FIELDDBUS_OUT-121	DOUT(457)	AUTO_RUN (Automatic operation on)
FIELDDBUS_OUT-122	DOUT(458)	CYC_END (Cycle end)
FIELDDBUS_OUT-123	DOUT(459)	LOW_ST (Low speed mode on)
FIELDDBUS_OUT-124	DOUT(460)	BT_ALM (Battery alarm)
FIELDDBUS_OUT-125	DOUT(461)	ALARM (Fault)
FIELDDBUS_OUT-126	DOUT(462)	EXT_ETHER (External mode on)

\* For details on the system signals, see the Interface Operation Manual.

**9. Simple PLC Function (TCmini)**

The TS series robot controllers include a built-in Simple PLC (TCmini) function. The Simple PLC can be used to perform any input/output to the fieldbus.

The Simple PLC function is an option. This page provides only the tables of TCmini addresses that are input and output to and from the fieldbus. For details on the Simple PLC Function, see the Simple PLC Function Operation Manual.

**9.1 Bit Input (FieldBUS→TCmini)**

Address Table

Bit	F	E	D	C	B	A	9	8	7	6	5	4	3	2	1	0
X20W	FI16	FI15	FI14	FI13	FI12	FI11	FI10	FI9	FI8	FI7	FI6	FI5	FI4	FI3	FI2	FI1
X21W	FI32	FI31	FI30	FI29	FI28	FI27	FI26	FI25	FI24	FI23	FI22	FI21	FI20	FI19	FI18	FI17
X22W	FI48	FI47	FI46	FI45	FI44	FI43	FI42	FI41	FI40	FI39	FI38	FI37	FI36	FI35	FI34	FI33
X23W	FI64	FI63	FI62	FI61	FI60	FI59	FI58	FI57	FI56	FI55	FI54	FI53	FI52	FI51	FI50	FI49
X24W	FI80	FI79	FI78	FI77	FI76	FI75	FI74	FI73	FI72	FI71	FI70	FI69	FI68	FI67	FI66	FI65
X25W	FI96	FI95	FI94	FI93	FI92	FI91	FI90	FI89	FI88	FI87	FI86	FI85	FI84	FI83	FI82	FI81
X26W	FI112	FI111	FI110	FI109	FI108	FI107	FI106	FI105	FI104	FI103	FI102	FI101	FI100	FI99	FI98	FI97
X27W	FI128	FI127	FI126	FI125	FI124	FI123	FI122	FI121	FI120	FI119	FI118	FI117	FI116	FI115	FI114	FI113

**9.2 Bit Output (TCmini→FieldBUS)**

Address Table

Bit	F	E	D	C	B	A	9	8	7	6	5	4	3	2	1	0
Y30W	FO16	FO15	FO14	FO13	FO12	FO11	FO10	FO9	FO8	FO7	FO6	FO5	FO4	FO3	FO2	FO1
Y31W	FO32	FO31	FO30	FO29	FO28	FO27	FO26	FO25	FO24	FO23	FO22	FO21	FO20	FO19	FO18	FO17
Y32W	FO48	FO47	FO46	FO45	FO44	FO43	FO42	FO41	FO40	FO39	FO38	FO37	FO36	FO35	FO34	FO33
Y33W	FO64	FO63	FO62	FO61	FO60	FO59	FO58	FO57	FO56	FO55	FO54	FO53	FO52	FO51	FO50	FO49
Y34W	FO80	FO79	FO78	FO77	FO76	FO75	FO74	FO73	FO72	FO71	FO70	FO69	FO68	FO67	FO66	FO65
Y35W	FO96	FO95	FO94	FO93	FO92	FO91	FO90	FO89	FO88	FO87	FO86	FO85	FO84	FO83	FO82	FO81
Y36W	FO11	FO11	FO11	FO10	FO10	FO10	FO10	FO10	FO10	FO10	FO10	FO10	FO10	FO99	FO98	FO97
Y37W	FO12	FO12	FO12	FO12	FO12	FO12	FO12	FO12	FO12	FO11	FO11	FO11	FO11	FO11	FO11	FO11

**9.3 Data Input (CC-Link→TCmini) \*CCLink only**

Address Table

Register	F	E	D	C	B	A	9	8	7	6	5	4	3	2	1	0
D70*	FB RW <sub>r</sub> 16	FB RW <sub>r</sub> 15	FB RW <sub>r</sub> 14	FB RW <sub>r</sub> 13	FB RW <sub>r</sub> 12	FB RW <sub>r</sub> 11	FB RW <sub>r</sub> 10	FB RW <sub>r</sub> 9	FB RW <sub>r</sub> 8	FB RW <sub>r</sub> 7	FB RW <sub>r</sub> 6	FB RW <sub>r</sub> 5	FB RW <sub>r</sub> 4	FB RW <sub>r</sub> 3	FB RW <sub>r</sub> 2	FB RW <sub>r</sub> 1

**9.4 Data Output (TCmini→CC-Link) \*CCLink only**

Address Table

Register	F	E	D	C	B	A	9	8	7	6	5	4	3	2	1	0
D74*	FB RW <sub>w</sub> 16	FB RW <sub>w</sub> 15	FB RW <sub>w</sub> 14	FB RW <sub>w</sub> 13	FB RW <sub>w</sub> 12	FB RW <sub>w</sub> 11	FB RW <sub>w</sub> 10	FB RW <sub>w</sub> 9	FB RW <sub>w</sub> 8	FB RW <sub>w</sub> 7	FB RW <sub>w</sub> 6	FB RW <sub>w</sub> 5	FB RW <sub>w</sub> 4	FB RW <sub>w</sub> 3	FB RW <sub>w</sub> 2	FB RW <sub>w</sub> 1

